



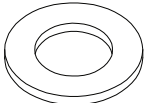
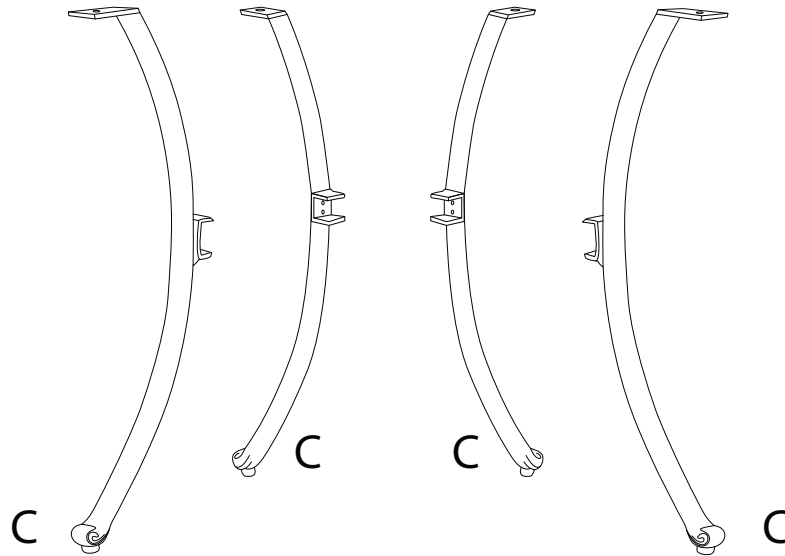
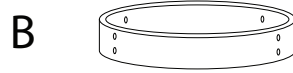
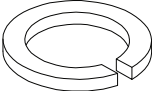
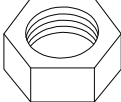

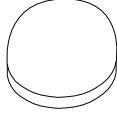

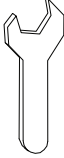

Diagram illustrating assembly instructions and safety warnings:









- Top Section:** A box containing icons for an Allen key and a wrench, a crossed-out power drill, and a warning triangle. To the right is a clock icon with the text "15'".
- Bottom Section:** A box containing icons for a rectangular block on a textured surface and a crossed-out block with a screw, and a warning triangle. To the right is a person icon with the text "1".

| | | | | |
|---|---|---|---|---|
| A | B | C | D | E |
|  |  |  |  |  |
| x 1 | x 1 | x 4 | x 4 | x 12 |

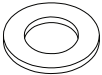
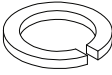

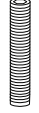



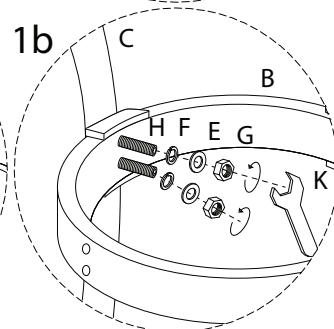
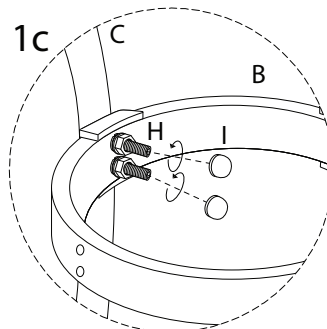
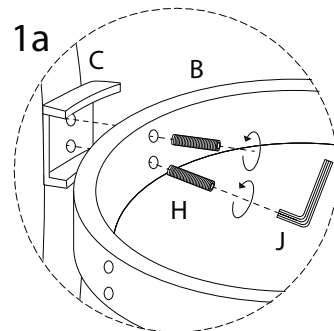
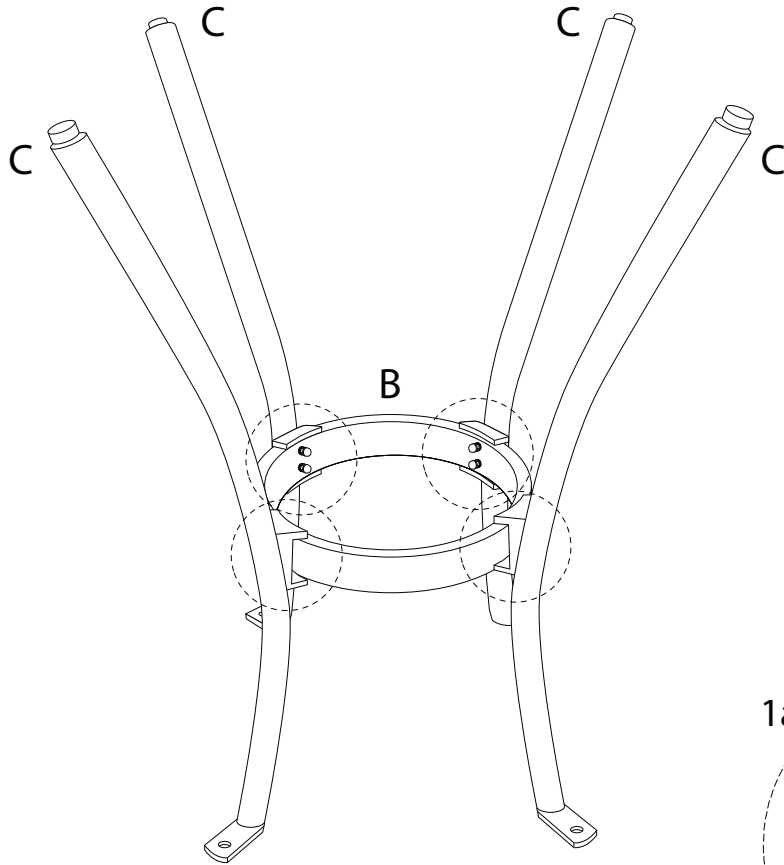

| | | | | | |
|---|---|---|---|---|---|
| F | G | H | I | J | K |
|  |  |  |  |  |  |
| x 12 | x 12 | x 8 | x 12 | x 2 | x 2 |

1

| | | | | |
|--|--|---|--|--|
| B  x 1 | C  x 4 | E  x 8 | F  x 8 | |
| G  x 8 | H  x 8 | I  x 8 | J  x 1 | K  x 1 |

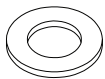
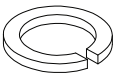

2

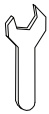
| | | | |
|--|--|---|--|
| A  x 1 | D  x 4 | E  x 4 | F  x 4 |
| G  x 4 | I  x 4 | J  x 1 | K  x 1 |

