

6000A

User Instructions

audiolab

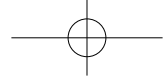

1 : Important Safety Information



This lightning flash with arrowhead symbol within an equilateral triangle is intended to alert the user to the presence of non-insulated “dangerous voltage” within the product’s enclosure that may be of sufficient magnitude to constitute a risk of electric shock.

Warning: To reduce the risk of electric shock, do not remove cover (or back) as there are no user-serviceable parts inside. Refer servicing to qualified personnel.

The exclamation point within an equilateral triangle is intended to alert the user to the presence of important operating and maintenance instructions in the literature accompanying the appliance.

IMPORTANT SAFETY INFORMATION

Read these instructions.

Keep these instructions.

Heed all warnings.

Follow all instructions.

Do not use this apparatus near water.

Clean only with dry cloth.

Do not block any ventilation openings. Install in accordance with the manufacturer’s instructions.

Do not install near any heat sources such as radiators, heat registers, stoves, or other apparatus (including amplifiers) that produce heat.

Do not defeat the safety purpose of the polarized or grounding-type plug. A polarized plug has two blades with

one wider than the other. A grounding plug has two blades and a third grounding prong. The wide blade or the third prong is provided for your safety. If the provided plug does not fit into your outlet, consult an electrician for replacement of the obsolete outlet.

Protect the power cord from being walked on or pinched particularly at the plugs, convenience receptacles, and at the point where they exit from the apparatus.



Use only with the cart, stand, tripod, bracket, or table specified by the manufacturer, or sold with the apparatus. When a cart or rack is used, use caution when moving the cart/apparatus combination to avoid injury from tip-over.

Unplug this apparatus during lightning storms or when unused for long periods of time.

Refer all servicing to qualified service personnel. Servicing is required when the apparatus has been damaged in any way, such as power supply cord or plug is damaged, liquid has been spilled or objects have fallen into the apparatus, the apparatus has been exposed to rain or moisture, does not operate normally, or has been dropped.

CAUTION: These servicing instructions are for use by qualified service personnel only. To reduce the risk of electric shock, do not perform any servicing other than that contained in the operating instructions unless you are qualified to do so.

Do not install this equipment in a confined or built-in space such as a bookcase or similar unit, and keep well ventilated in open space. The ventilation should not be impeded by covering the ventilation openings with items such as newspaper, table-cloths, curtains etc.

WARNING: Only use attachments/accessories specified or provided by the manufacturer (such as the exclusive supply adapter, battery etc).

WARNING: Please refer to the information on the exterior panel of the enclosure for electrical and safety information before installing or operating the apparatus.

WARNING: The battery (battery or batteries or battery pack) shall not be exposed to excessive heat such as sunshine, fire or the like.

CAUTION: Danger of explosion if battery is incorrectly replaced. Replace only with the same or equivalent type.

WARNING: For the terminals marked with symbol of “” may be of sufficient magnitude to constitute a risk of electric shock. The external wiring connected to the terminals requires installation by an instructed person or the used of ready-made leads or cords.

Mains Supply: The mains operating voltage of Audiolab 6000 series units is shown on the rear panel. If this voltage does not match the mains voltage in your area, consult your Audiolab dealer about converting the unit.

The mains supply fuse on the rear panel is accessible when the IEC mains plug has been removed. In the rare event that it has broken, check for any obvious cause before replacing the fuse with one of the correct rating and type.

The fuse values are:

220 – 240V (UK, China, etc.) T2.0AL 250V Slow Blow

100 – 120V (USA, Japan, etc.) T4.0AL 250V Slow Blow

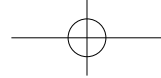

2: Getting Started

Welcome to Audiolab 6000 Series.

6000A is the latest in a long line of Audiolab integrated amplifiers with a pedigree that stretches back to the very first 8000A that made Audiolab an overnight sensation.

The 6000A features analogue and digital audio circuitry of the highest quality and has been designed by engineers who are passionate about the reproduction of music, and we hope you will enjoy its performance for many years to come.

Please read through this manual to obtain the very best performance from your 6000A.

Features:

- Bluetooth aptX
- DAC – ES9018K2M
- Dedicated high performance MM Phono Input.
- Separate Pre-Power sections for flexibility of operation.
- Automatic equipment activation via 12V trigger.
- Auto standby function.

Inputs:

- Three analogue line level inputs.
- One Phono input (MM)
- One Power-Amp input
- Two Coaxial SPDIF digital inputs
- Two Optical SPDIF digital inputs
- Bluetooth (aptX)

Outputs:

- Pre-Amplifier output.
- Loudspeaker output.
- Headphone output.

Unpacking

Unpack the product fully. The carton should contain:

- The Audiolab 6000A
- One IEC power cord suitable for your area.
- One Remote handset with two AAA batteries
- This instruction manual.
- One Bluetooth Antenna

If an item is missing or damaged report this to your dealer as soon as possible. Retain the packing for safe transport of your unit. If you dispose of the packing, do so with regard to any recycling regulation in your area.

Placement

The unit is designed to run warm during normal operation but ensure you do not block any ventilation openings.

Place the unit on a sturdy shelf or table. If you use an equipment rack, ensure the unit has adequate ventilation and is on its own shelf.

Check your mains voltage corresponds to the rating printed on the rear panel (near the power inlet socket).

If in doubt, consult your dealer. If you move to an area with a different mains voltage seek advice from an Audiolab appointed dealer or a competent service technician.

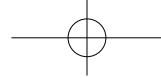

3: Controls and Connectors

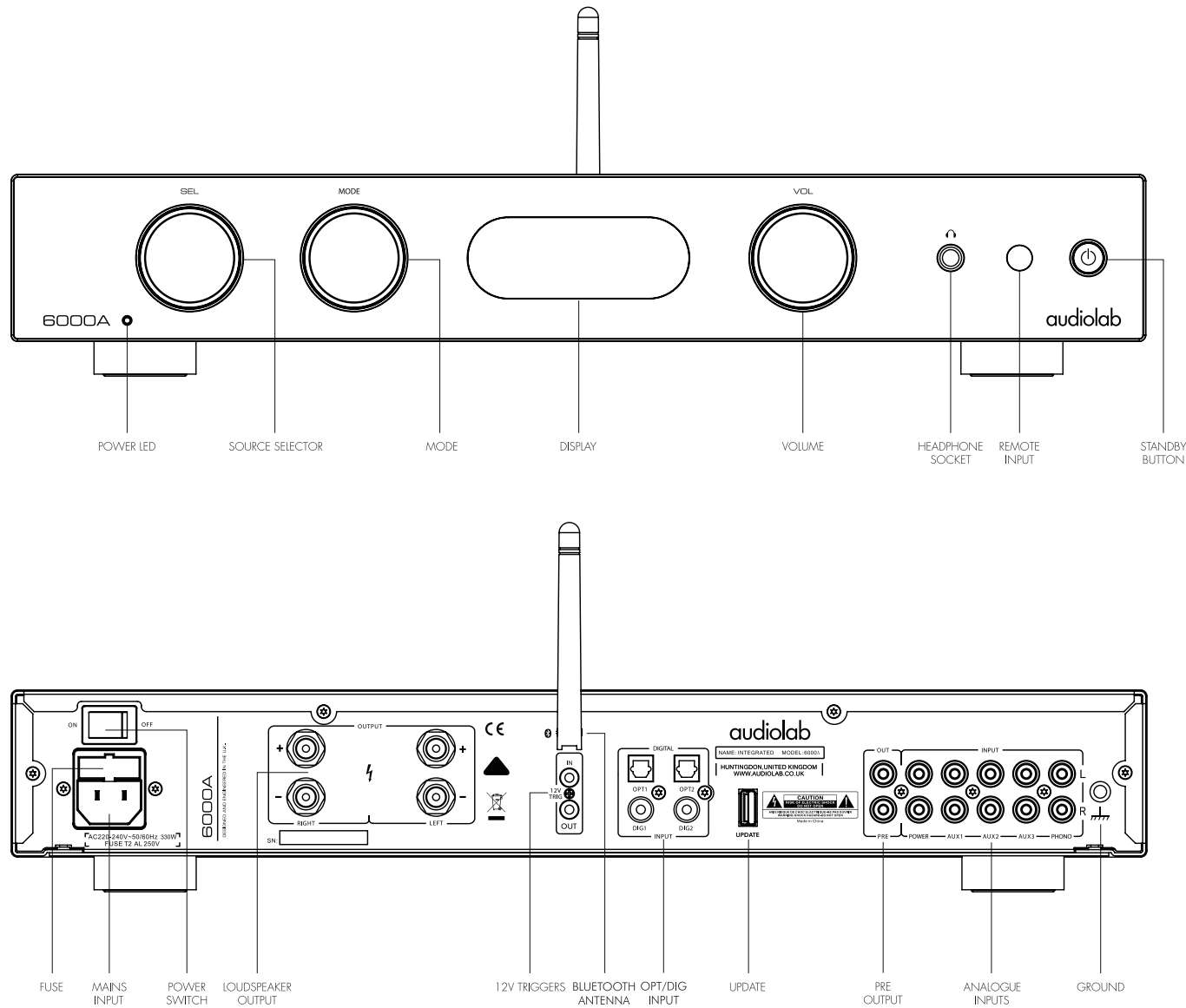



4: Remote Handset

NOTE : the handset buttons shown crossed out are for use with other Audiolab units like Audiolab 6000CDT and are not operational when used with the 6000A

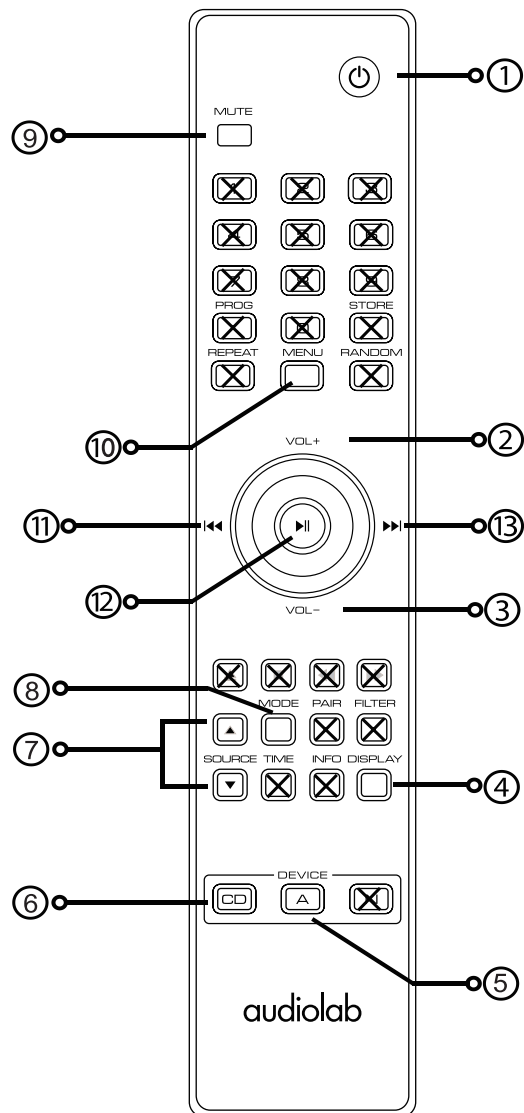

- 1 STANDBY Press to bring the unit in/out of Standby
- 2 VOL+ Increase Volume
- 3 VOL- Decrease Volume
- 4 DISPLAY Press to toggle the display on/off
- 5 A Press to select 6000A remote mode
- 6 CD Press to select 6000CDT remote mode
- 7 SOURCE Press to cycle source inputs
- 8 MODE Press to select 6000A operating mode
- 9 MUTE Press to mute and unmute the sound
- 10 MENU Press to enter MENU
- 11 ⏮ Press once to replay the current track of BT
- 12 ⏸ Move to previous page or setting in menu
- 13 ⏭ Press to start / pause BT playback
- 14 ⏩ Press to confirm page or setting selected in menu
- 15 ⏭ Move to the next track of BT
- 16 ⏭ Move to next page or setting in menu

Fitting Batteries

Open the battery compartment cover, unwrap the supplied AAA batteries and place them in the battery compartment with the correct polarity. Replace the cover.

Always use AAA batteries and replace them in sets - never mix old and new batteries.

Very weak batteries can leak and damage the handset. Replace them in good time!

Note: there is a risk of fire and burns if a battery is handled improperly. Do not disassemble, crush, puncture, short the contacts or dispose of the batteries in fire or water.

Do not attempt to open or service a battery. Discard used batteries in full accordance with recycling regulations in force in your area.

Handset Operation

The handset operates several Audiolab components. The handset buttons shown crossed out are for use with other Audiolab units and are not operational when used with the 6000A.

Point the handset at the remote receiver and press the relevant key. The handset should be within 15 meters of the player and there must be a clear line of sight between the two units.



5: Connections

Analogue Inputs (Line Level)

Connect your analogue sources to one of the three line level inputs, AUX1, AUX2 or AUX3.

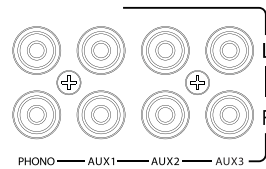

Phono Input (MM)

Connect your Turntable (Moving Magnet cartridge) to the PHONO Input. Connect the Earth lead from your Turntable (if available) to the GROUND terminal.

Coaxial digital Inputs

Connect your coaxial digital sources to either DIG1 or DIG2.

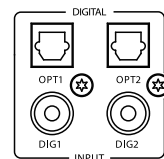

Optical digital Inputs

Connect your Optical digital sources to either OPT1 or OPT2.

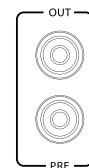

Pre-Amplifier Output

Pre-amplifier output for driving external power amplifiers, sub-woofers or signal processors.

Loudspeaker Terminals

One set of Loudspeaker output terminals.

Headphone Output

A stereo 6.3mm (1/4") jack is provided on the front panel for connecting Headphones.

When Headphones are connected the audio to the loudspeakers terminals will be cut off.

Bluetooth Connection

Select BT source on the 6000A, on your mobile device search for 'Audiolab 6000A BT' and connect.

Once paired the front panel SOURCE indicator will be turned on. If you switch to another input on the 6000A your mobile device will be disconnected after 60 sec. To reconnect, select BT on the 6000A and it will connect to the last paired device, or select 'Audiolab 6000A BT' on your mobile device in the Bluetooth menu and it will reconnect.

12V Trigger Connections

The 6000A features two 12V Trigger connections, one output and one input. Use the output to control other products (ie. Audiolab amplifiers or 3rd party compatible equipment). Use the input when the 6000A is to be controlled (ie. by Audiolab 6000CDT, or 3rd party compatible equipment).

The Trigger connections are made using 3.5mm to 3.5mm jack interconnects (not incl.).

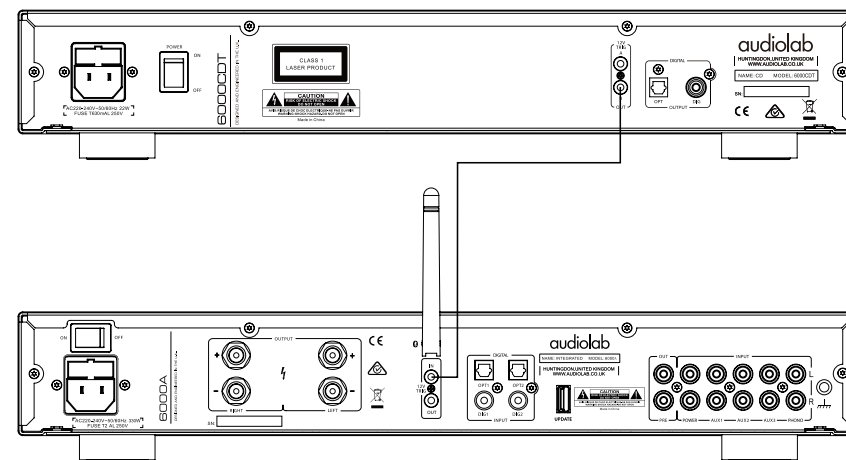

Mains Input

Before connecting the 6000A to the mains supply make sure all other connections to your system have been properly and securely made. Make sure the ON/OFF switch on the rear of the unit is switched off.

Now connect the supplied mains cable to the AC supply outlet.

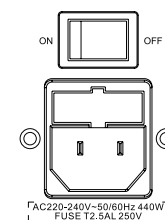

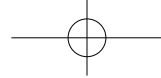

6: Operation

Switching On and Off

Switch on all source units before switching on power to the 6000A.

When switching On: The power LED illuminates.

When switching Off: Switch off the 6000A before the source units.

Standby Mode

The 6000A will enter standby mode after being powered on. Press the "Standby" button to bring the 6000A out of standby, the power indicator LED becomes brighter and the display shows "6000A" welcome screen while the unit is getting ready for operation.

The Auto Standby feature will, by default, put the unit into standby after 20min of inactivity.

This feature can be configured using the MENU (see page 8) and be set to 20min, 1hour or Never.

Source Select

Rotate the SEL knob on the front panel or use the source buttons on the remote handset to select different source inputs.

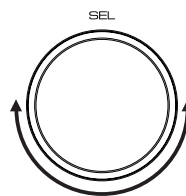

Volume Control

Rotate the VOL knob on the front panel, or use the Volume up/down keys on the remote control, to set the volume level. The range is -78dB to +8dB, the factory default volume setting is -20dB. When coming out of standby the 6000A will be set to the previous used volume setting, except if louder than -20dB, in which case the volume will default to -20dB.

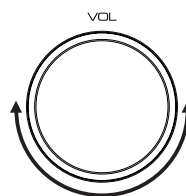

Mute

Press the VOL knob on the front panel or the MUTE button on the remote handset to mute / un-mute the sound.

Display Setting

The DISPLAY button on the remote control will toggle the front panel display ON/OFF.

When the display is OFF: Using the front panel controls or pressing any remote key will momentarily turn on the display, after 5 sec. the display will go off.

Digital Filter selection (DAC)

The DAC in the 6000A has a choice of 3 digital filters. Press the MENU key on the remote control to access the FILTER options (see page 8 for further details)

- Filter = Fast : Standard flat response with fast frequency roll off above $F_s/2$ (half the sampling frequency)
- Filter = Slow: Starts rolling off at a lower frequency than the Fast filter but has a more gentle rate of attenuation.
- Filter = Phase: Has a gentle attenuation slope similar to the Slow filter but with minimum phase characteristics. It can be likened to an analogue filter applied in the digital domain.

6: Operation - 2

Operating Modes

Although the 6000A is an integrated amplifier it can function as a separate Pre and Power amplifier.

Use the MODE knob on the front panel, or the MODE key on the Remote control, to select different operating modes.

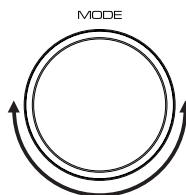

MODE	POWER AMP IN	PRE OUT	HEADPHONE OUT	LOUDSPEAKERS
PRE	DISABLE	ACTIVE	ACTIVE	DISABLE
PRE-POWER	ACTIVE	ACTIVE	ACTIVE	ACTIVE
INTEGRATED	DISABLE	ACTIVE	ACTIVE	ACTIVE

Integrated mode

The pre-amplifier section is internally connected to the power amplifier, Pre-amplifier output is also operational in this mode. A second power amplifier can be connected for bi-amplification as shown in the diagram.

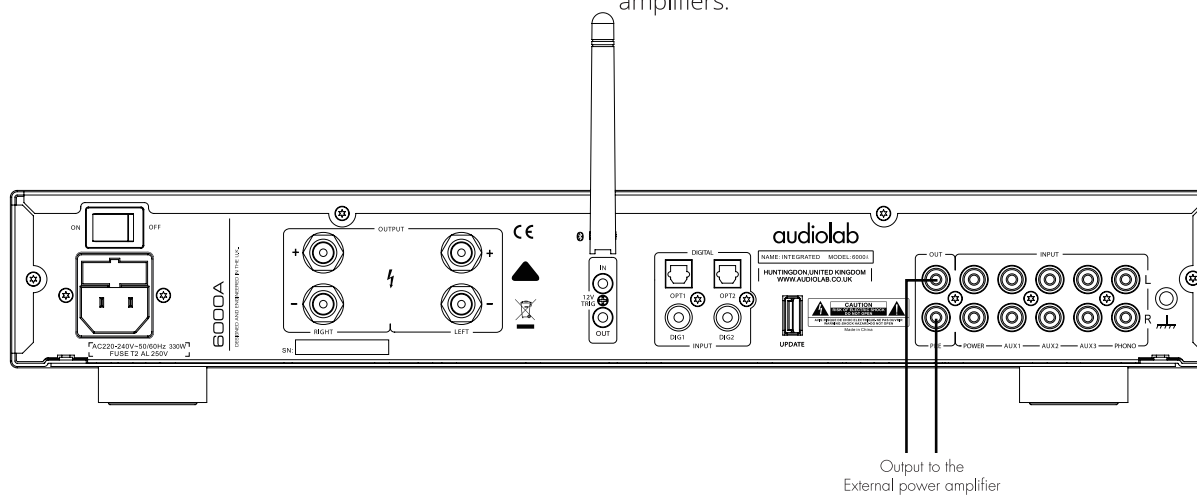

Pre-Power mode

The pre-amplifier section is internally disconnected from the power amplifier. The 6000A can be used as a stand alone power amplifier (ie. part of an AV setup). This mode can also be used if additional signal processing is required, connecting the Pre-out to an external signal processor and then take the output from the processor to the 6000A Power-IN.

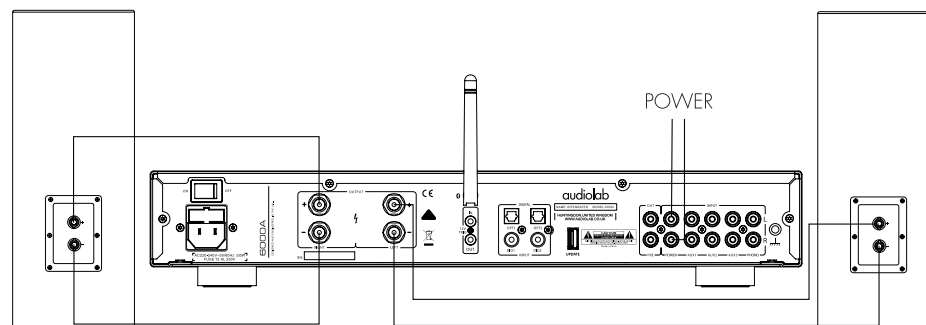

Pre Mode

All signals to and from the power amplifier of the 6000A are disconnected. In this mode, the 6000A functions as a stand-alone pre-amplifier. The pre-amplifier section of the 6000A can be connected to a stereo power amplifier, or to two mono-block amplifiers.

6: Operation - 3

The MENU

The menu enables you to customize the unit and optimize the interface with other equipment in your system.

6000A has 6 different menu pages. Press the MENU key on the remote control to enter menu mode, and then press ◀◀ or ▶▶ to turn to different menu pages, press ▶▶ to enter any menu page, press ◀◀ or ▶▶ again to select different settings, Pressing the MODE knob on the front panel can also enter the menu mode, rotating this knob turns through the menu pages; press the MODE knob again to enter any menu page and rotate the knob to change the setting, press the MODE knob again to select a setting.

No operation for 5 seconds will also exit menu mode automatically

The Menu Tree

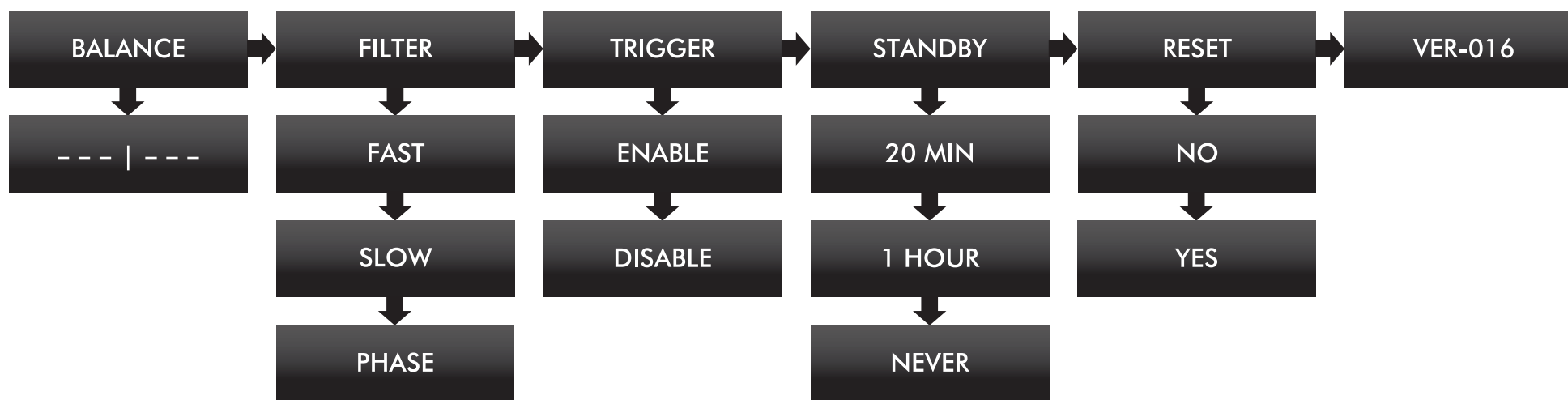

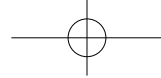

7: Warranty

Audiolab Ltd. warrants this product, subject to the terms and conditions below, to be free from defects in materials and workmanship. During the warranty period Audiolab will repair or replace (at Audiolab's option) this product, or any defective part in this product, if it is found to be defective due to faulty materials, workmanship or function. The warranty period may vary from country to country.

Terms and conditions

The warranty starts on the date of purchase (or the date of delivery if this is later).

You must provide proof of purchase/delivery before work can be carried out. Without this proof, any work carried out will be chargeable to you.

All work will be carried out by Audiolab or its authorized agents or distributors.

Any unauthorized repair or modification will void this warranty.

If any part is no longer available it will be replaced with a functional replacement part.

Any parts that are replaced will become the property of Audiolab.

Any repair or replacement under this warranty will not extend the period of warranty.

This warranty is valid only in the county of purchase, applies only to the first purchaser and is not transferable.

The following are not covered:

1. Products where the serial number has been removed, altered or otherwise made illegible.
2. Normal wear tear and cosmetic damage.
3. Transportation or installation of the product.

Accidental damage, fault caused by commercial use, acts of God, incorrect installation, connection or packing, misuse, neglect or careless operation or handling of the product which is not in accordance with Audiolab's user instructions.

1. Repairs or alterations carried out by parties other than Audiolab or its authorized agents or distributors.
2. Products not purchased from an Audiolab authorized dealer.

3. Products that were not new at the time of original purchase.

4. Products sold 'as is', 'as seen' or 'with all faults'.

Repairs or replacements as provided under this warranty are the exclusive remedy of the consumer.

Audiolab shall not be liable for any incidental or consequential damages for breach of any express or implied warranty in this product. Except to the extent prohibited by law, this warranty is exclusive and in lieu of all other warranties whatsoever, both express and implied, including, but not limited to, the warranty of merchantability and fitness for a practical purpose.

This warranty provides benefits that are additional to and do not affect your statutory rights as a consumer.

Some countries and U.S. states do not allow the exclusion or limitation of incidental or consequential damages or implied warranties so the exclusions in the paragraph above may not apply to you. This warranty gives you specific legal rights, and you may have other statutory rights, which vary from state to state or county to county.

How to claim:

To obtain warranty service contact the Audiolab authorized dealer from which you purchased this product. Do not dispatch goods without the prior agreement of the dealer, Audiolab or their authorized distributors.

If asked to return products for inspection and/or repair, pack carefully, preferably in the original cartons or packing affording an equal degree of protection, and return prepaid. If unsuitable packaging is used, Audiolab may make a charge for the supply of new packaging.

Insurance is recommended and goods are returned at owner's risk. Audiolab or their authorized distributors cannot be held liable for loss or damage in transit.

8: Specification

Pre-amplifier Section	
Gain (max.)	+8dB (Line) +55dB (Phono MM)
Input Sensitivity	720mV (Line, Volume = 0dB) 3.1mV (Phono MM, Volume=0dB)
Input Impedance	10K (Line) 47K//100pF (Phono MM)
Total Harmonic Distortion (THD)	< 0.0004% (Line, 1KHz @ 2V, Volume = 0dB)
Frequency Response	20Hz-20kHz (+/-0.1dB)
Output Voltage	2.3V max. (Volume = 0dB)
Output Impedance	120 ohm
Signal-to-Noise Ratio (S/N)	> 110dB (Line, A-weighted) >76dB (Phono MM, A-weighted)

DAC	
D to A converter	ES9018K2M
Total Harmonic Distortion (THD)	< 0.0006% (1KHz @ 0dBFS)
Output level (0dBFS, 1KHz)	2.05V
Max. Sampling Frequency	192KHz
Signal-to-noise ratio (S/N)	> 112dB (A-weighted)
Digital Filters	Fast Roll-off , Slow Roll-off , Minimum Phase

Power Amplifier Section	
Gain	+29dB
Rated Max. Power Output	2 X 50W (8 ohm, THD<1%) 2 X 75W (4 ohm, THD<1%)
Frequency Response	20Hz-20kHz (+/-0.3dB)
Input Sensitivity	720mV
Total Harmonic Distortion (THD)	<0.003% (1kHz @ 40W/8ohm)
Signal-to-Noise ratio (S/N)	> 110dB (A-weighted)
Max. Output Current	9A

Headphone Amplifier	
Total Harmonic Distortion (THD)	< 0.01% (1kHz, 50mW)
Output Impedance	2.35 ohm
Load impedance	20-600 ohm

General	
Standby Power Consumption	<0.5W
Power Requirements	240V ~ 50 - 60Hz 230V ~ 50 - 60Hz 115V ~ 50 - 60Hz 100V ~ 50 - 60Hz
Dimensions (mm) (W x H x D)	445 x 65.5 x 300
Carton Size (mm) (W x H x D)	512 x 467 x 146
Weight	7.8kg (Net)



Correct disposal of this product. This marking indicates that this product should not be disposed with other household wastes throughout the EU. To prevent possible harm to the environment or human health from uncontrolled waste disposal, recycle it responsibly to promote the sustainable reuse of material resources. To return your used device, please use the return and collection systems or contact the retailer where the product was purchased. They can take this product for environmental safe recycling.



Audiolab
IAG House,
13/14 Glebe Road,
Huntingdon,
Cambridgeshire,
PE29 7DL,
UK
Tel: +44(0)1 480 452561
Fax: +44(0)1 480 41 3403
<http://www.audiolab.co.uk>
CODE: AH14-MNLO004a

