

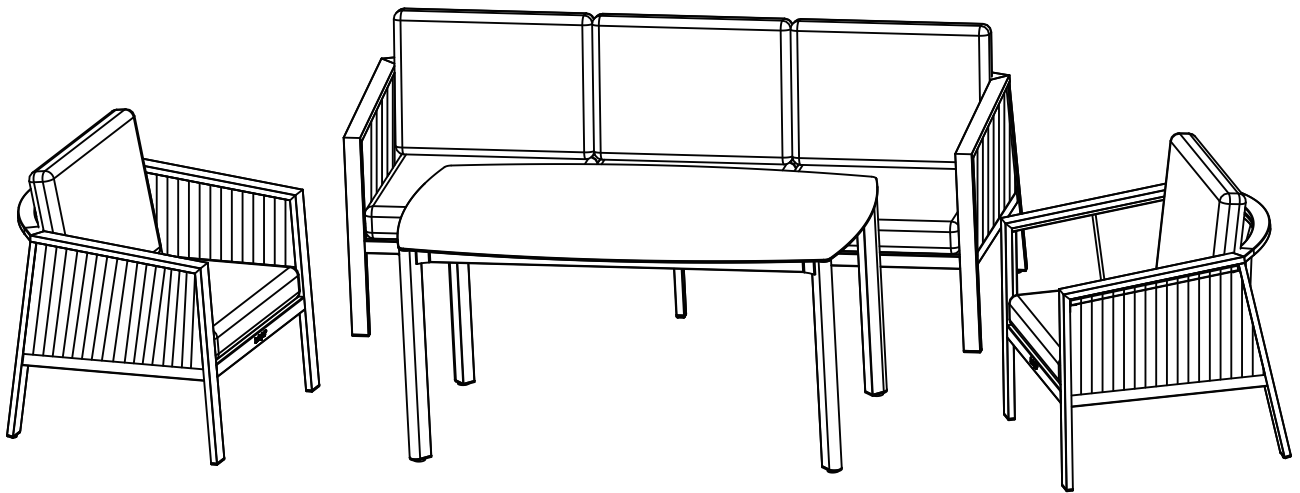









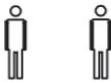
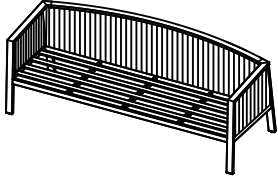
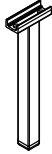
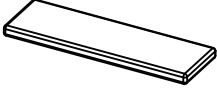
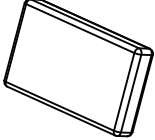

Lanterfant[®]



Loek

 50Min	
---	---

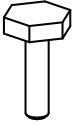
A		1
B		1
C		1
D		3
E		4
F		4
G		1

H0		1
J20	 M6*20	2
L15	 M6	2
H3		1
N30	 M8*30	8
L04	 M8	8
L06	 M8	8

