

# VARIN<sup>®</sup>



## FLOOR LAMP WITH SHELVES MODEL: KL-1734WF-A

## USER MANUAL

Latest update 08/2022

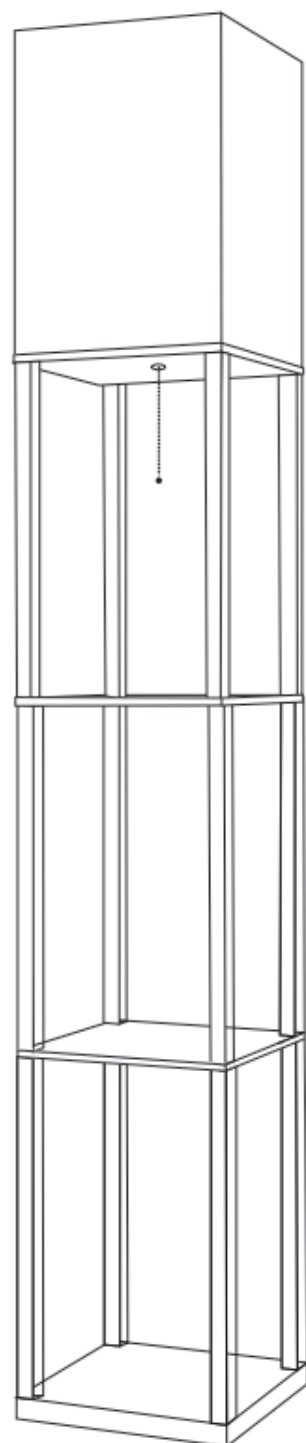

EN

NL

FR

DE



Please read this manual - Keep these instructions for future reference

Lees deze handleiding - Bewaar deze instructies voor toekomstig gebruik

Veillez lire ce manuel - Conservez ces instructions pour référence future

Bitte lesen Sie dieses Handbuch - Bewahren Sie diese Anleitung zum späteren Nachschlagen



## EN-SAFETY INSTRUCTIONS

---

**Please read the following carefully before us!**

- Do not look directly at the light source to avoid eye discomfort.
- This lamp is for indoor use only.
- Keep out of reach of children and animals.
- Place the lamp on flat surface and ensure placed away from flammable materials.
- Before cleaning the lamp, ensure it is switched off.
- Do not pull the plug out of the socket with wet hands.
- If the supply cord is damaged it must be replaced by manufacturer or electrical qualified person to avoid a hazard.
- The light source of this product are non-replaceable light emitting diodes (LED). Do not disassemble the product, as the LEDs may cause damage to the eyes.
- Do not use in bathroom or wet/moist places.



## NL-VEILIGHEIDSINSTRUCTIES

---

**Lees het volgende aandacht door voor gebruik!**

- Kijk niet direct in de lichtbron om ongemak aan de ogen te voorkomen.
- Deze lamp is alleen voor gebruik binnenshuis
- Buiten het bereik van kinderen en dieren houden.
- Plaats de lamp op een vlakke ondergrond en zorg ervoor dat deze uit de buurt van brandbare materialen wordt geplaatst.
- Controleer voordat u de lamp reinigt of deze is uitgeschakeld.
- Trek de stekker niet met natte handen uit het stopcontact.
- Als het netsnoer beschadigd is, moet het worden vervangen door de fabrikant of een elektrisch gekwalificeerd persoon om gevaar te voorkomen.
- De lichtbron van dit product zijn niet-vervangbare lichtgevende diodes (LED). Haal het product niet uit elkaar, aangezien de LED's schade aan de ogen kunnen veroorzaken.
- Niet gebruiken in badkamer of natte/vochtige plaatsen.



## FR-CONSIGNES DE SÉCURITÉ

---

**Veillez lire attentivement ce qui suit avant nous!**

- Ne regardez pas directement la source lumineuse, pour éviter toute gêne oculaire
- Cette lampe est destinée à un usage intérieur uniquement.
- Tenir hors de portée des enfants et des animaux.
- Placez la lampe sur une surface plane et assurez-vous qu'elle est placée à l'écart des matériaux inflammables.
- Avant de nettoyer la lampe, assurez-vous qu'elle est éteinte.
- Ne débranchez pas la fiche de la prise avec les mains mouillées.
- Si le cordon d'alimentation est endommagé, il doit être remplacé par le fabricant ou une personne qualifiée en électricité pour éviter tout danger.
- La source lumineuse de ce produit est constituée de diodes électroluminescentes (DEL) non remplaçables. Ne démontez pas le produit, car les LED peuvent endommager les yeux.
- Ne pas utiliser dans la salle de bain ou dans des endroits mouillés/humides.



## DE-SICHERHEITSHINWEISE

---

**Bitte lesen Sie das Folgende sorgfältig vor uns!**

- Schauen Sie nicht direkt in die Lichtquelle, um Augenbeschwerden zu vermeiden!
- Nur für den Innengebrauch bestimmt.
- Halten sie die Lampe aus der Reichweite von Kindern und Tieren.
- Stellen Sie die Lampe auf flachen Oberflächen und nicht in der Nähe von entzündlichen Materialien auf.
- Bevor Sie die Lampe reinigen, stellen Sie sicher, dass sie ausgeschaltet wurde.
- Ziehen Sie nicht am Stecker mit nassen Händen.
- Wenn das Netzkabel beschädigt ist, muss es vom Hersteller oder einer qualifizierten Elektriker ersetzt werden, um Gefahren zu vermeiden.
- Die Lichtquelle dieses Produkts sind nicht austauschbare Leuchtdioden (LED). Zerlegen Sie das Produkt nicht, da die LEDs die Augen schädigen können.
- Nicht im Badezimmer oder an nassen/feuchten Orten aufstellen.



# EN-INSTALLATION STEPS | NL-INSTALLATIE STAPPEN FR-ÉTAPES D'INSTALLATION | DE-INSTALLATIONSSCHRITTE

THESE ARE PARTS INCLUDED IN THE BOX | DEZE ONDERDELEN ZITTEN IN DE DOOS

CE SONT DES PIÈCES INCLUSES DANS LA BOÎTE | DIES SIND DIE TEILE, DIE IN DER SCHACHEL ENTHALTEN SIND

**A**

1x | Bottom shelf  
Onderste plank  
Étagère inférieure  
Grundboden

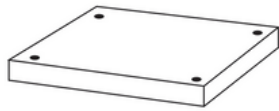

**B**

2x | Shelf  
Plank  
Étagère  
Regal

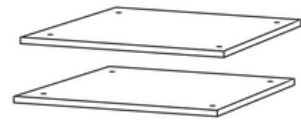

**C**

12x | Pole part  
Paal delen  
Partie polaire  
Stangenteil



**D**

1x | Lamp holder shelf  
Lamphouder plank  
Étagère porte-lampe  
Regal Lampenhalter

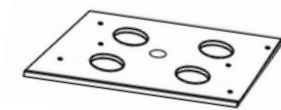

**E**

1x | Tool  
Gereedschap  
Outil  
Werkzeug



**F**

10x | Large screw  
Grote schroef  
Grosse vis  
Große Schraube



**G**

10x | Double-sided screw  
2-zijdige schroef  
Vis double face  
2-seitige Schraube



**H**

4x | Round cushions  
Ronde viltjes  
Coussins ronds  
Runde Polster

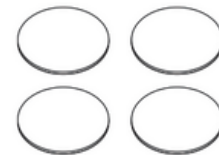

**I**

1x | Lamp holder  
Lamphouder  
Support de lampe  
Lampenhalter



**J**

1x | Shade brackets  
Kap beugels  
Supports d'abat-jour  
Schattenhalter

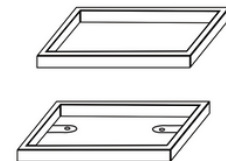

**K**

1x | Fabric shade  
Linnen kap  
Abat-jour en tissu  
Schirm aus Stoff

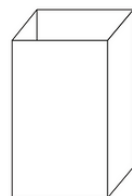

**L**

3x | Small screw  
Kleine schroef  
Petite vis  
Kleine Schraube



**M**

2x | Wing nut  
Vleugelmoer  
Écrou papillon  
Flügelmutter



**N**

4x | Cord clips  
Kabelclips  
Clips de cordon  
Schnur-Clips



Some extra fasteners are included | er zijn wat extra bevestigingsmiddelen meegeleverd

Certaines attaches supplémentaires sont incluses | Einige zusätzliche Befestigungselemente sind enthalten



STEPS 1-4 | STAPPEN 1-4

ÉTAPES 1-4 | SCHRITTE 1-4

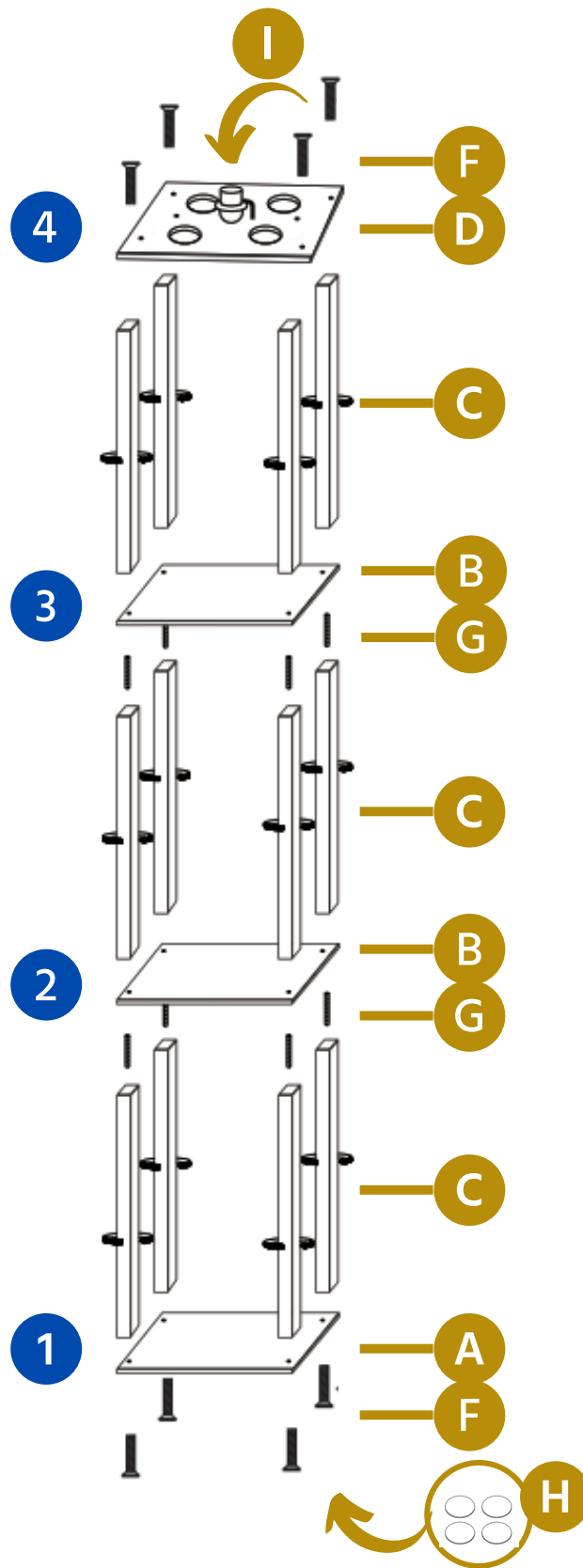

EN-Assemble from bottom to top & rotate the poles so the board is connected to the pole.

NL-Monteer van onder naar boven & Draai de paal zodat de plank met de paal is verbonden.

FR-Assembler de bas en haut & Faites pivoter le poteau pour que la carte soit connectée au poteau.

DE-Von unten nach oben zusammenbauen & Drehen Sie die Stange so, dass die Regal mit der Stange verbunden ist.



STEPS 5-7 | STAPPEN 5-7  
ÉTAPES 5-7 | SCHRITTE 5-7

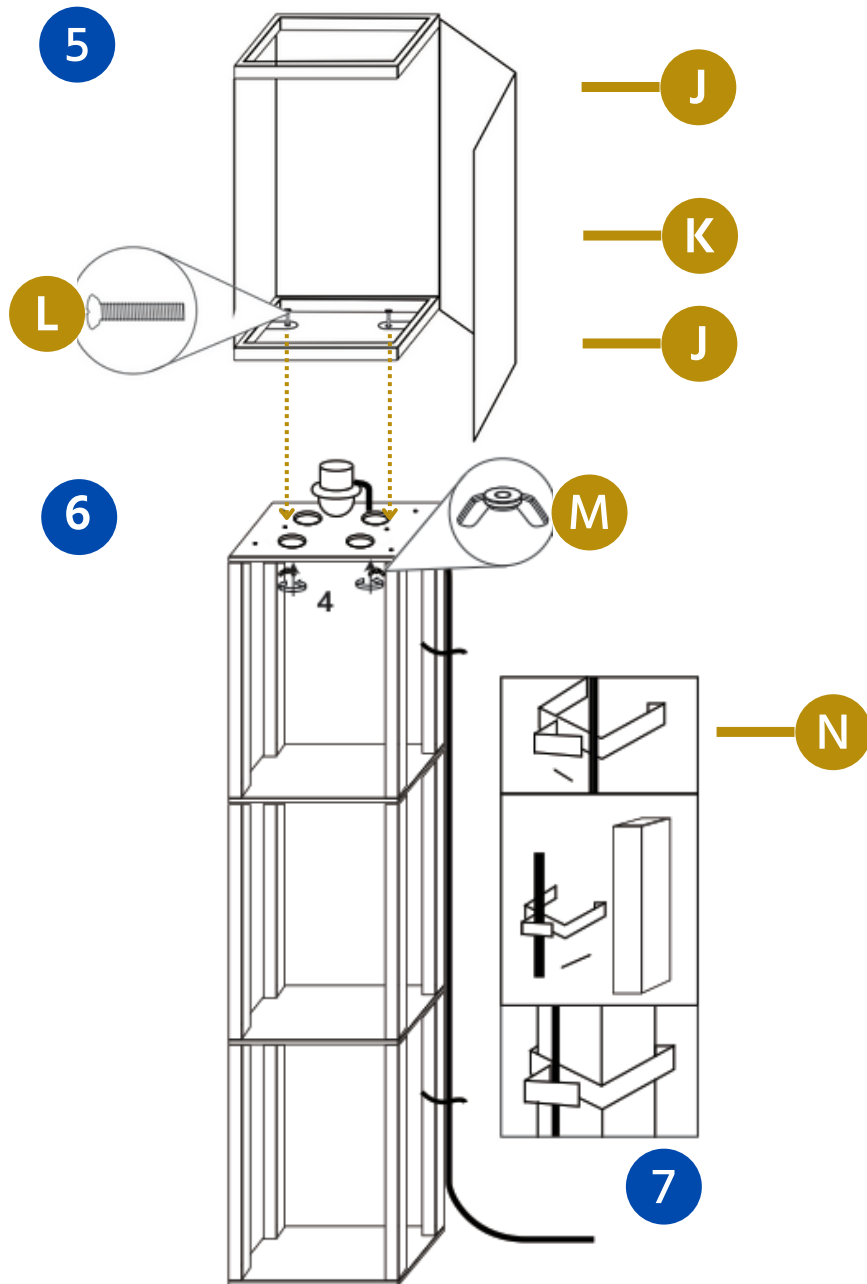

EN-Be careful with the linen shade & place the lamp with velcro corner and the cable on the least visible side.

NL-Wees voorzichtig met de linnen kap & plaats de lamp met klittenband hoek en de kabel aan minst zichtbare zijde.

FR-Faites attention à l'abat-jour en lin et placez la lampe avec le coin velcro et le câble du côté le moins visible.

DE-Seien Sie vorsichtig mit dem Leinenschirm und platzieren Sie die Lampe mit Klettverschluss und das Kabel auf der am wenigsten sichtbaren Seite.



EN-These are optional instructions, only applicable when a Tuya WiFi LED Bulb is added to the package.

NL-Dit zijn optionele instructies, alleen van toepassing wanneer een Tuya WiFi LED-lamp aan het pakket is toegevoegd.

FR-Ce sont des instructions facultatives, applicables uniquement lorsque l'ampoule LED WiFi Tuya est ajoutée au colis.

DE-Dies sind optionale Anweisungen, die nur anwendbar sind, wenn Tuya WiFi LED Bulb dem Paket hinzugefügt wird.

EN-The app is working in 60+ languages, the instruction below is in English, but the pictures shows all steps and possibilities.

NL-De app werkt in meer dan 60 talen, de onderstaande instructie is in het Engels, maar de foto's tonen alle stappen en mogelijkheden.

FR-L'application fonctionne dans plus de 60 langues, les instructions ci-dessous sont en anglais, mais les images montrent toutes les étapes et possibilités.

DE-Die App funktioniert in über 60 Sprachen, die Anleitung unten ist auf Englisch, aber die Bilder zeigen alle Schritte und Möglichkeiten.

## 1 Download app

Scan QR code or download "Tuya Smart"  
in Google Play / App Store  
*Alternative: de lamp can also be operated with the "Smart Life" app*



Tuya Smart App



Smart Life App



## 2 Tuya Smart or Smart Life APP

1. Open the APP
2. Make an account, the first time
3. Press the orange "+" at the top right > Add Device
4. Click on "Lighting" left
5. Select "Bulb (Wi-Fi)" right

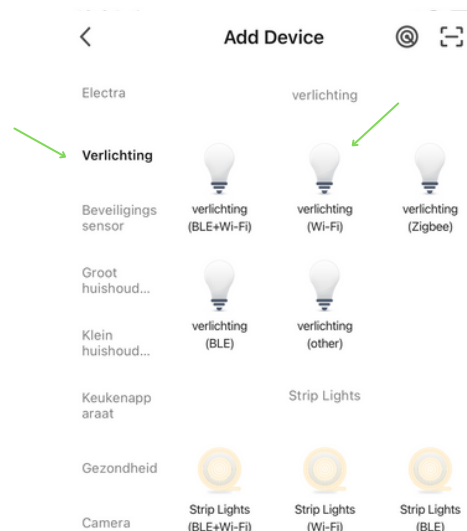
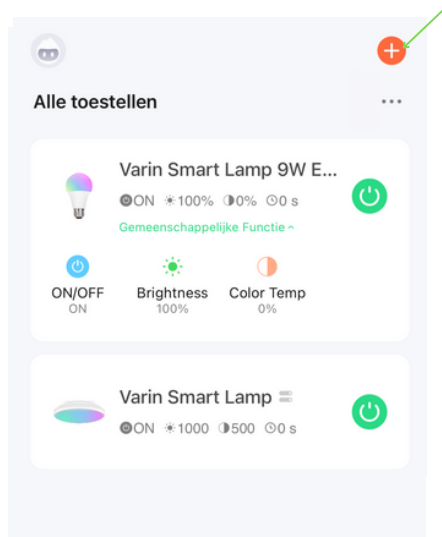

## 3

6. Reset the lamp, see app instructions
7. Connect with Wi-Fi network

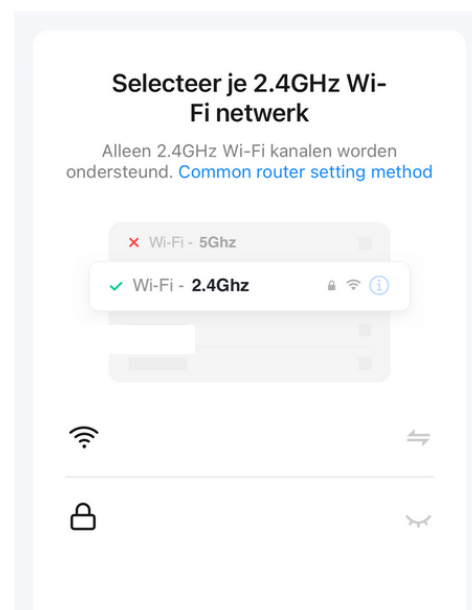
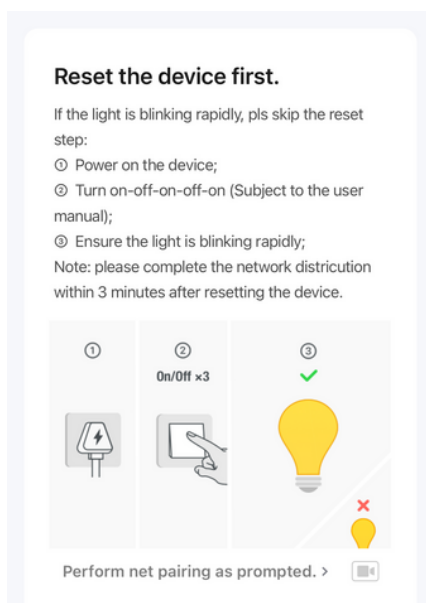



4

8. Lamp is paired

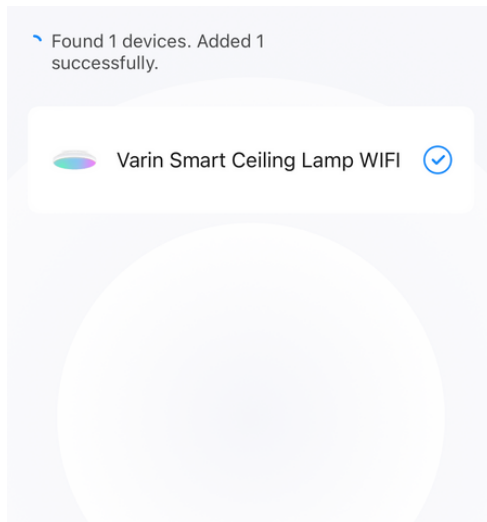

9. Lamp has been added and name can be changed



5

10. Adjust the color by clicking and the brightness by sliding

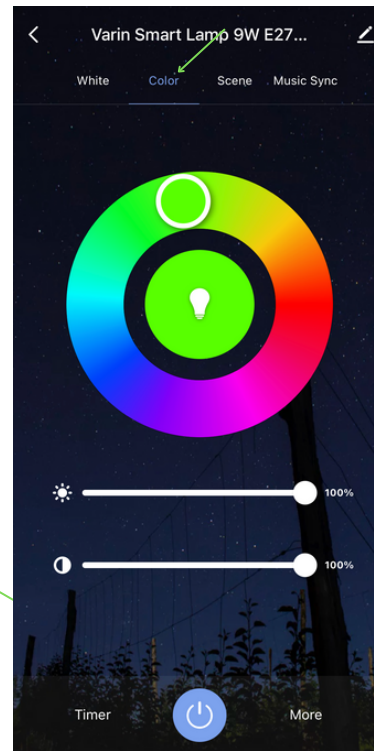
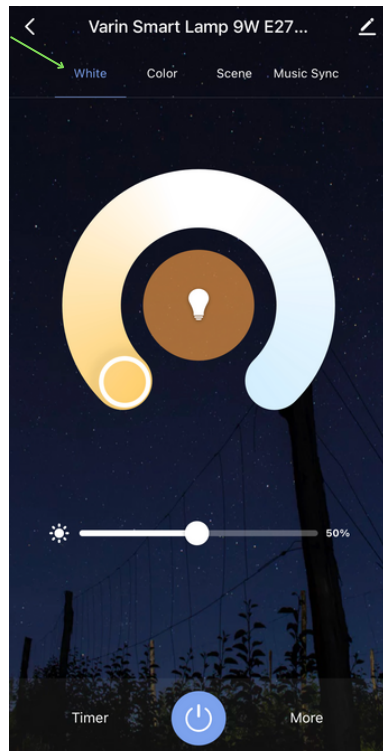





**6** 11. Choose scenes

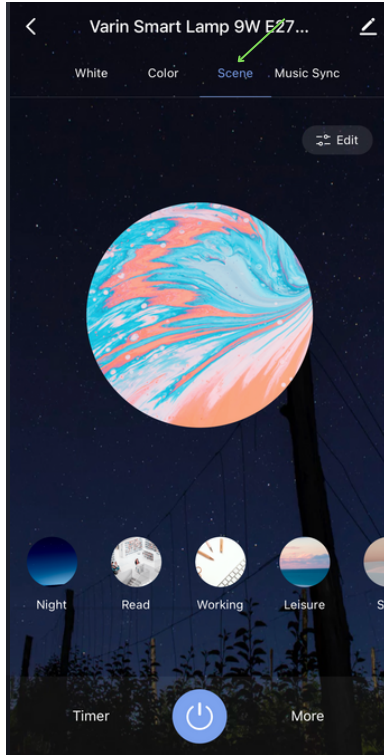

12. Set plans/time schedules

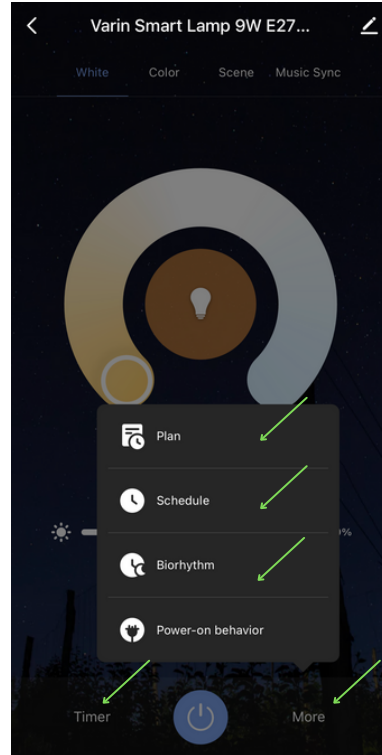

**7** 13. Set light mode for wall or cord switch

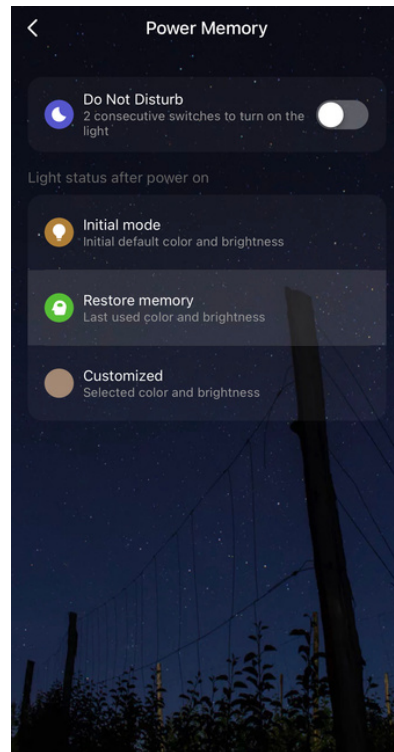
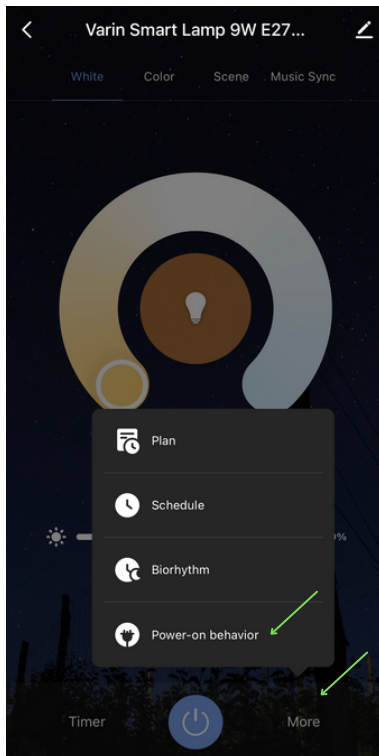



8

### 14. Customize lamp name / create group(s)

Varin - Slaapkamer 

Toestel Info >

Tap-to-Run en Automatisering >

Ondersteunde Apparatuur Van Derden



Alexa



Google Assistant



XIAODU



Tmall Genie

Melding Bij Offline

Melding Bij Offline

Andere

Toestel Delen >

Creëer Groep >

FAQ & Feedback >

Toevoegen aan beginscherm >

### 15. Pair with Alexa or Google Assistant

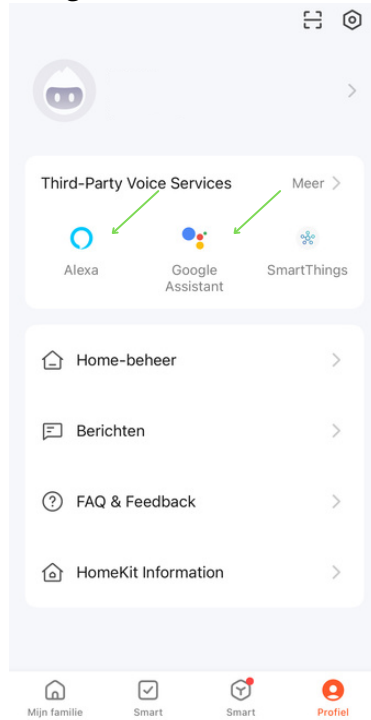



# EN-APP INSTRUCTIONS | NL-APP INSTRUCTIES FR-INSTRUCTIONS APP | DE-APP ANWEISUNGEN



EN-Space for notions related to app use and configuration smart lamps and products.

NL-Ruimte voor notities met betrekking tot app-gebruik en configuratie smart lampen en andere smart producten.

FR-Espace pour les notions liées à l'utilisation et à la configuration des lampes et produits intelligents de l'application.

DE-Platz für Anmerkungen zur App-Nutzung und Konfiguration intelligenter Lampen und Produkte.



**VARIN<sup>®</sup>**

## **VARIN<sup>®</sup> FLOOR LAMP WITH SHELVES**

**Material: Pine Wood & Linen**

**Dimensions: 160 x 26 x 26 cm**

**Lamp base: E27**

**Maximum wattage: 60W**

**Input Voltage: AC 100-240V~50/60Hz**

**Model: KL-1734WF-A**

**Optional:**

**Tuya Smart / Smart Life App instructions  
for WiFi lamp**

**Importer:**

**Varin - Veenweg 22 - 8075 PS - Elspeet**

**The Netherlands**



**RoHS**



**Made in PCR**