

PAWBO® Crunchy



Quick Start Guide

Package Contents

- Crunchy (Lid / Bowl / Desiccant)
- Micro USB cable
- Adapter

Specifications

- Brand: PAWBO
- Model: PPC-PF01
- Capacity: 6 L
- Bowl Capacity: 120 g (4.23 oz)
- Button: Feeding, Reset, Power, Bluetooth
- LED: Power (Red), Bluetooth (Blue), Wi-Fi (White)
- Weight Sensor: Hopper x 4, Bowl x 1
- Wi-Fi: 2.4G (802.11 b/g/n)
- Bluetooth: v4.2 BR/EDR and BLE with BLE Beacon
- Adapter: 5V / 2A
- Speaker: 8Ω / 1W
- Dimensions (W x H x L): 361 x 422 x 328 mm/14.2 x 16.6 x 12.9 in
- Weight: 2.3 kg / 5.1 lbs

Requirements

Smart phone with:
iOS 8.0 or above, or
Android 4.4 or above

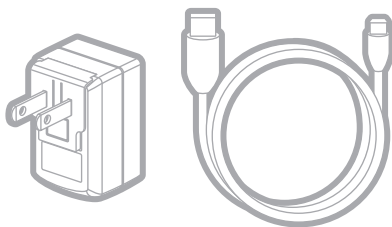
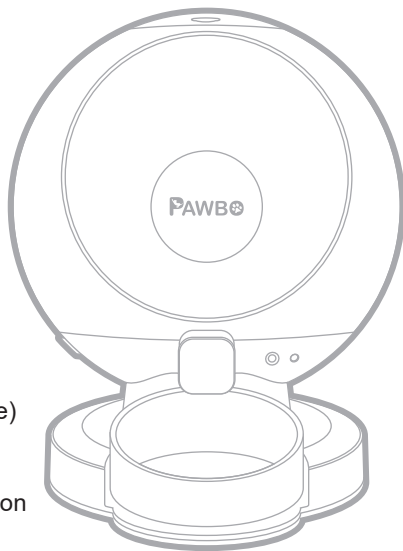

Safety Information

- Do NOT place any foreign objects in Crunchy.
- Do NOT use Crunchy outdoors. Crunchy is for indoor household use only.
- Do NOT use an appliance for anything other than its intended use.
- Do NOT allow children to play or around Crunchy.
- Do NOT disassemble Crunchy other than components as instructed in this guide.
- Do NOT install or store Crunchy in the environment where it is exposed to weather or temperatures below -20°C (-4°F).
The base should NOT be submerged in water at any time, as this may damage the electronic components.
- Do NOT use Crunchy with puppies, kittens, dogs or cats not able to reach the food tray or with any physical disability.
- Do NOT operate any appliance with a damaged power cord or plug, malfunction or it has been damaged. Call the Customer Center immediately for further instructions.
- Do NOT allow pets to chew on or swallow any parts. If you are concerned about the power cord, purchase a cord conduit (a hard plastic protector) to protect the power cord.
- Do NOT attempt to repair Crunchy by yourself.

Important Safety Information

- If an extension cord is necessary, an extension cord with a proper rating should be used.
- Do NOT use pet feeder for anything other than intended use. Using attachments not recommended or sold by the manufacturer may cause an unsafe condition.
- Do NOT lift Crunchy by lid, hopper, bowl or bowl holder. Lift and carry Crunchy using both hands on the hopper base, while keeping unit in upright position.
- For dry food only. DO NOT use wet, canned or moist food.
- To avoid tripping, always position power cord out of the way of foot traffic.
- If the plug of this device gets wet, turn off the electricity to that wall outlet. Do not attempt to unplug.
- Examine this appliance after installation. Do not plug in if there is water on the power cord or plug.
- To reduce the risk of injury, close supervision is necessary when an appliance is used by or near children.
- If using power cord, do not place power cord or plug in water or other liquids.
- Dispose of all packaging materials properly. Some items may be packed in polybags; these bags could cause suffocation; keep away from children and pets.

Overview

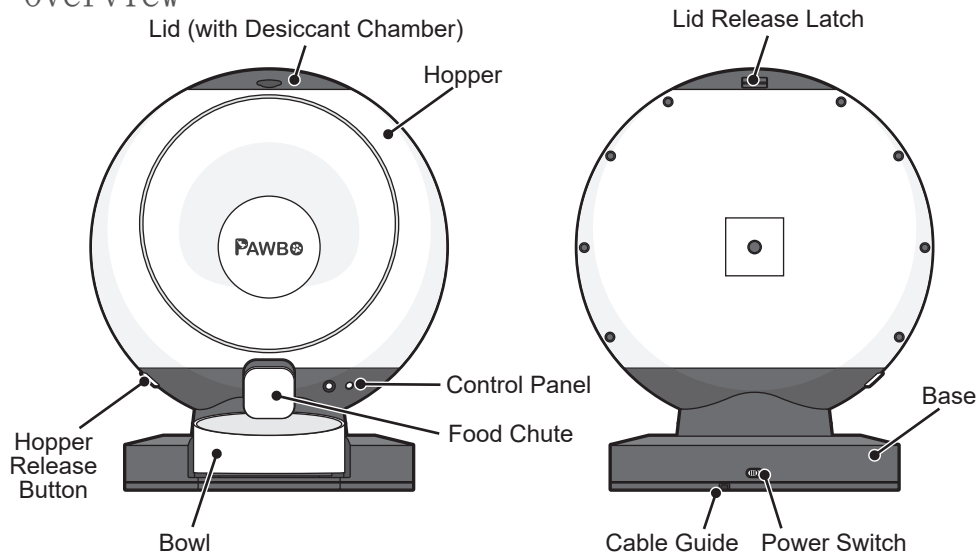

Control Panel

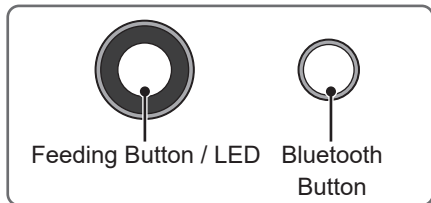

LED Status

- Blinking blue:** Booting / Bluetooth status / Pairing
- Solid blue:** Bluetooth connected
- Blinking white:** Configuring Wi-Fi access
- Solid white:** Wi-Fi enabled
- Blinking red:** Resetting
- Solid red:** Fault detected

Foot Pad / Weight Sensor

Foot pads are precision weight sensors.

If severe shaking or excessive pressure is applied to Crunchy, it is recommended to empty the hopper and re-calibrate.

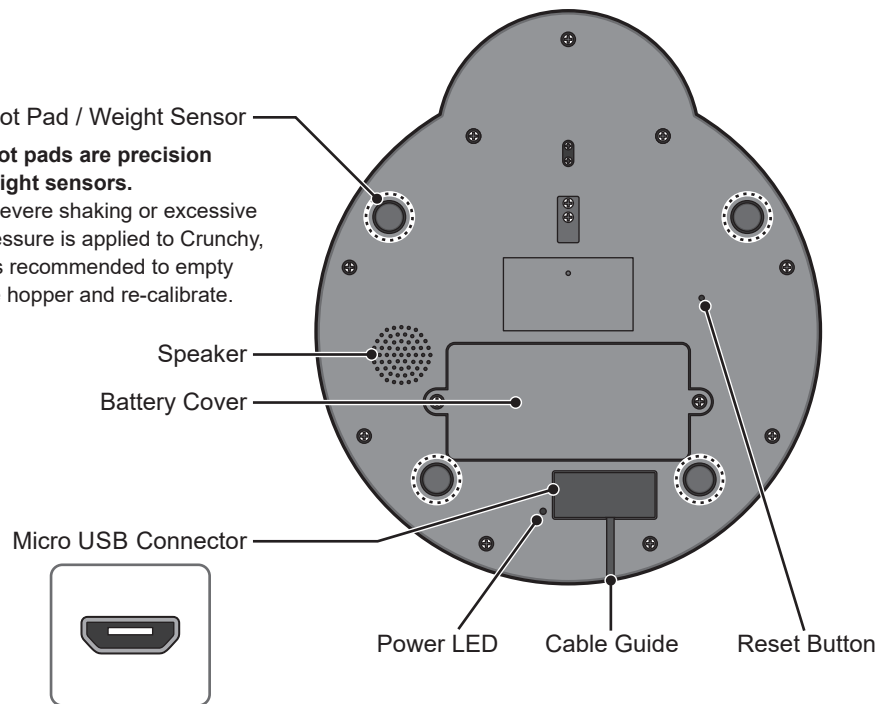

Installation

Crunchy Assembly

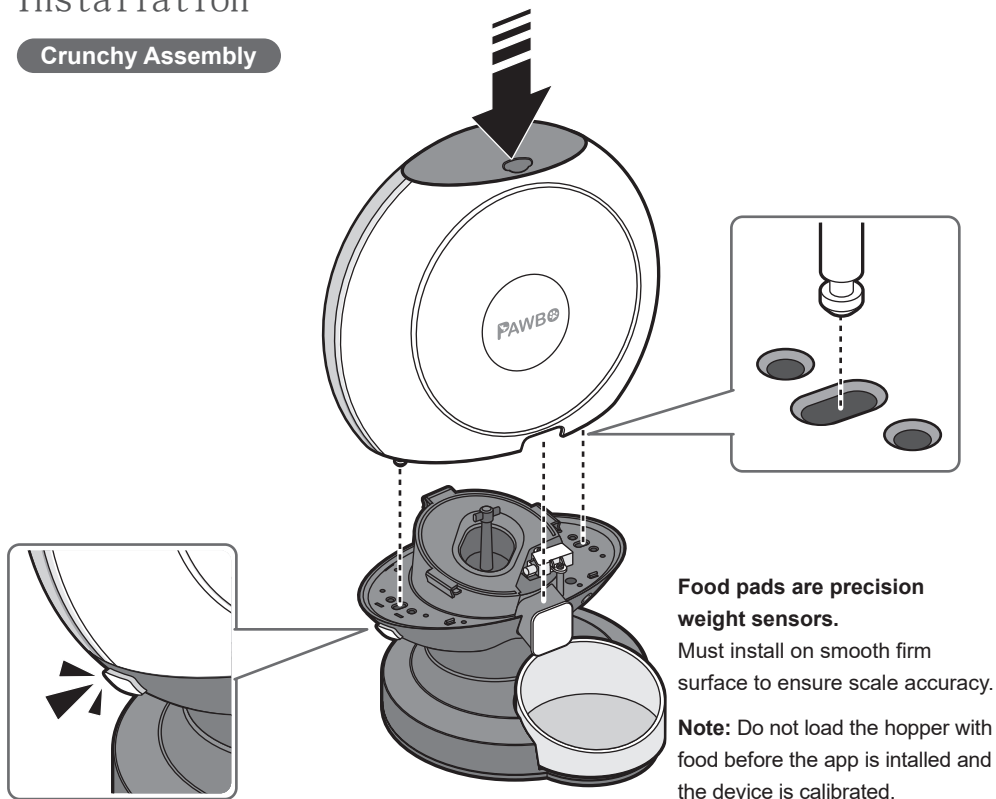

Installing Backup Batteries

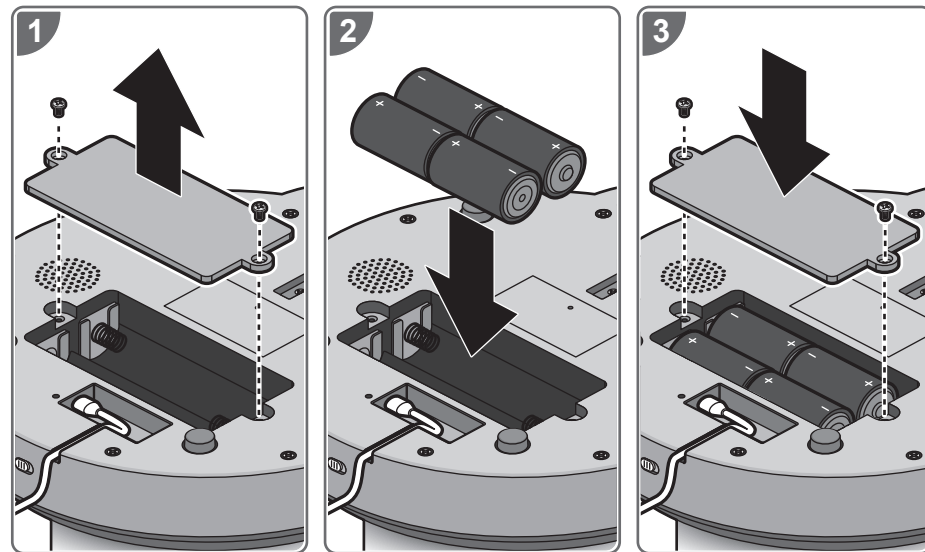

If battery replacement is required:

1. First turn off Crunchy.
2. After replacing, turn on Crunchy and re-calibrate to ensure the scale is set to zero.

Installing Adapter

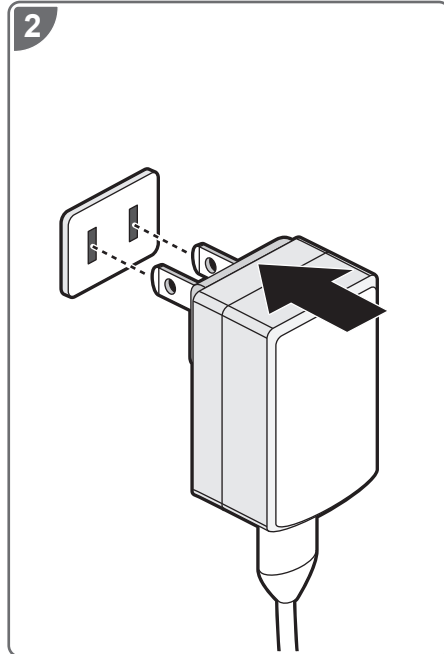
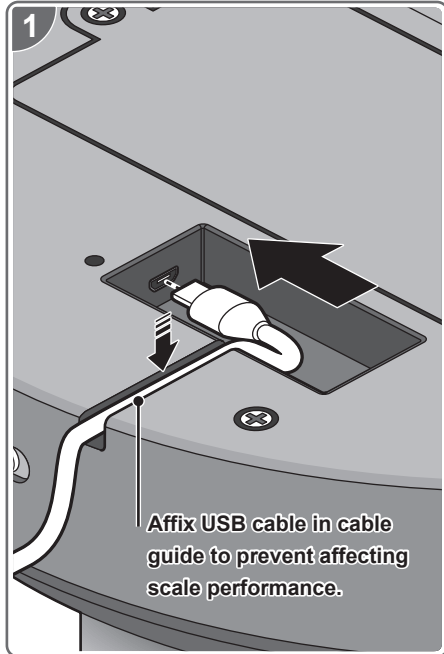

Initial Setup

Adding a Device

1. Tap **Register** to create a user profile.

Upon registration success, a verification email is sent to complete and activate the profile.

Once activated, tap **Log In** to use the profile.

Alternatively, tap (G) or (f) for cloud-based accounts.

First time users, tap **Country/Region** then make a selection. Tap **OK** then **Done** to complete the logging in process.

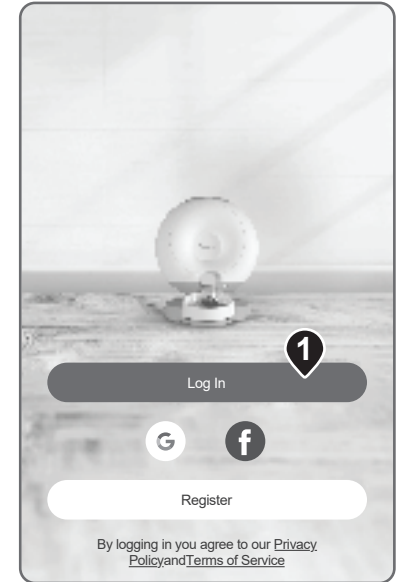

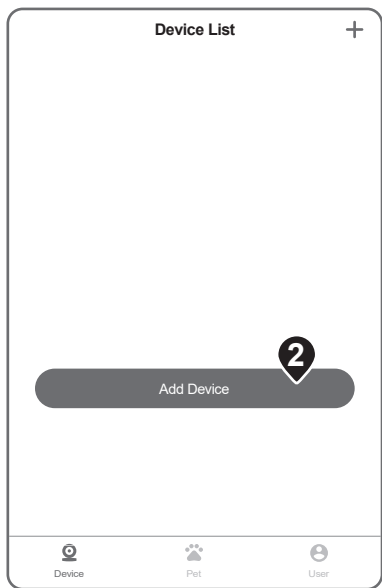

2. Click **Add Device**

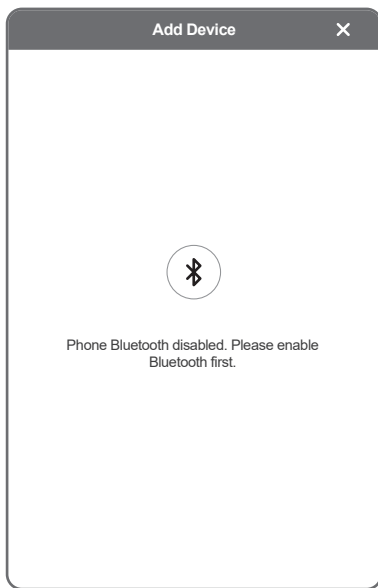

3. Enable Bluetooth on the smart phone.

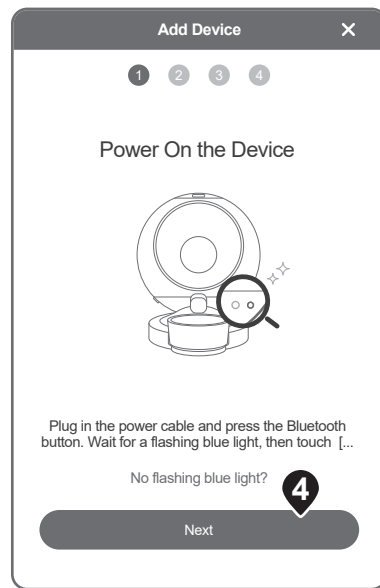

4. Power on the device. The LED button flashes blue, press the button to pair it. Tap **Next** to pair.



5. Tap the discovered device.

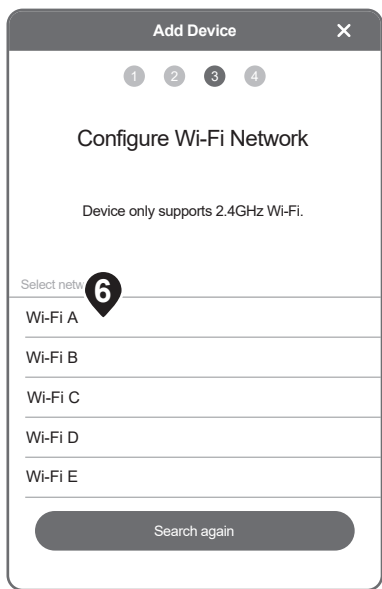

6. Select the discovered Wi-Fi network.

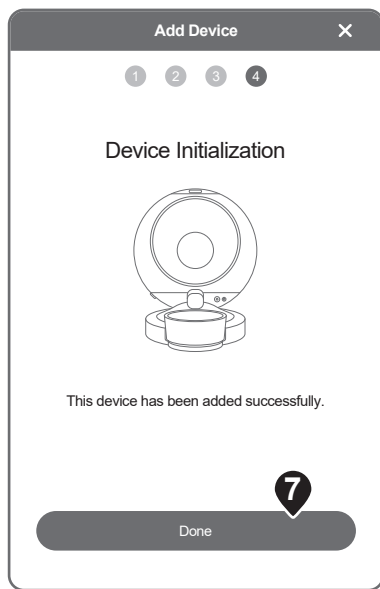

7. Once paired, the device successfully initializes. The device is now added.

Setting Up a Device

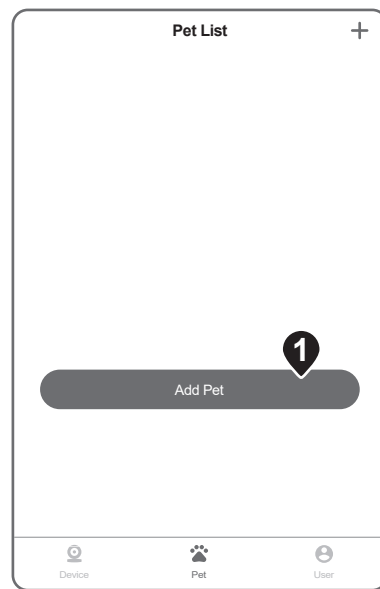

1. From Device List, tap **Pet** (🐾). Tap **Add Pet**.

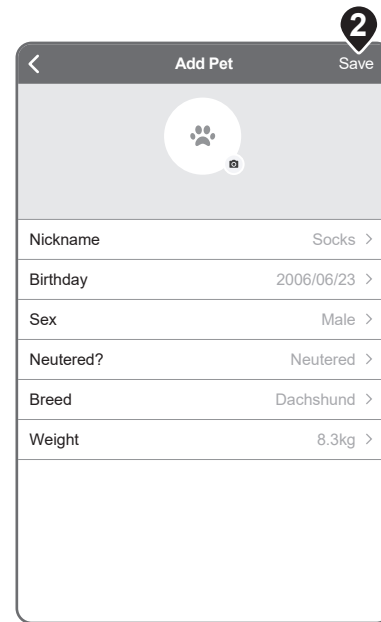

2. Enter your pet information. Tap **Save** to return to the main menu.

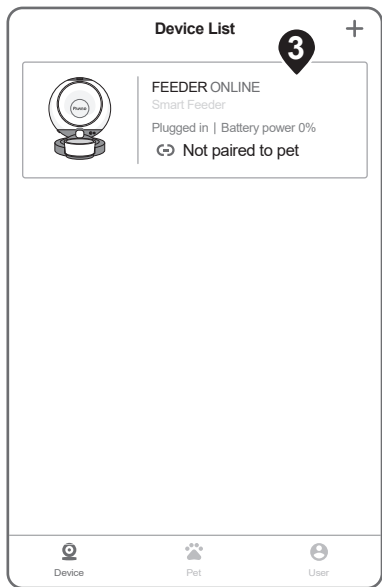

3. From Device List, tap the device to set up.

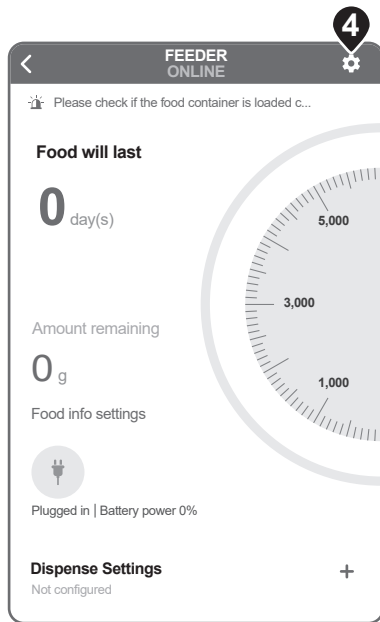

4. Tap **Settings** (⚙️).

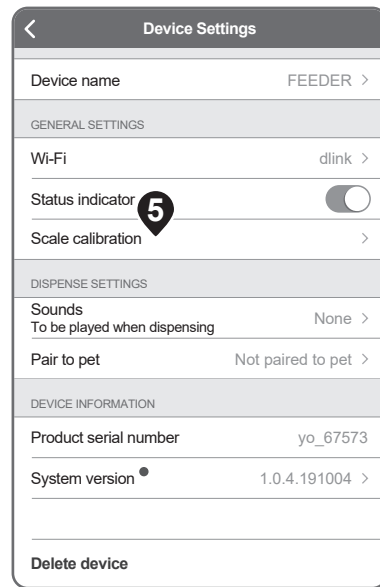

5. Tap **Scale calibration**.

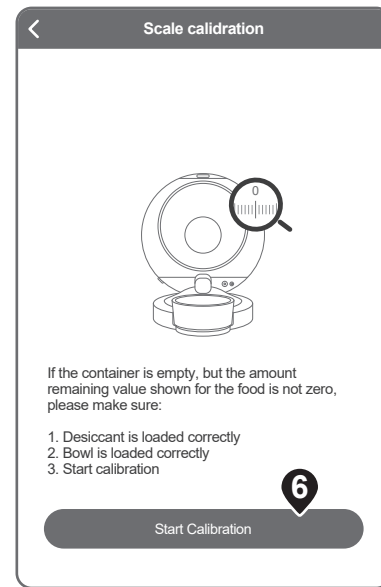

6. Tap **Start Calibration**.

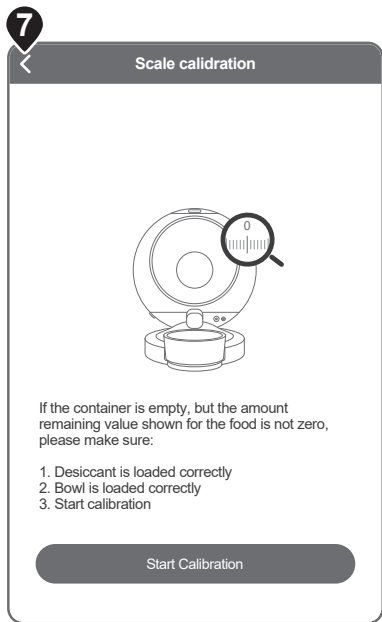

7. Tap **Back** (<) to return to the Device Menu.
Now load the hopper with food.

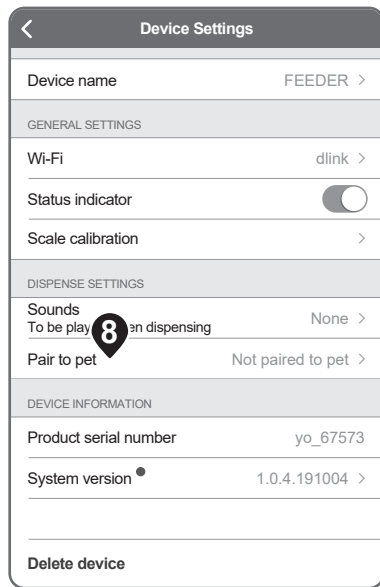

8. Tap **Pair to Pet**.

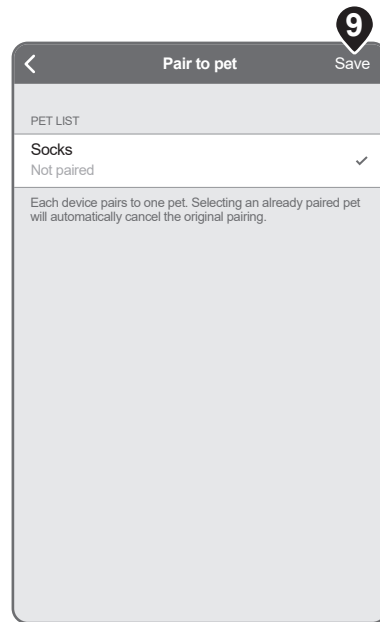

9. From Pet List, select your pet.
Tap **Save**.

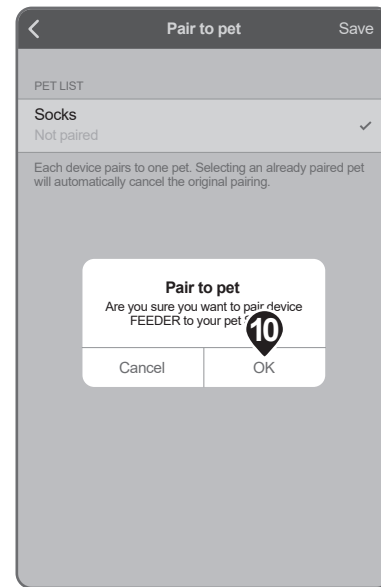

10. Tap **OK** to confirm pairing.

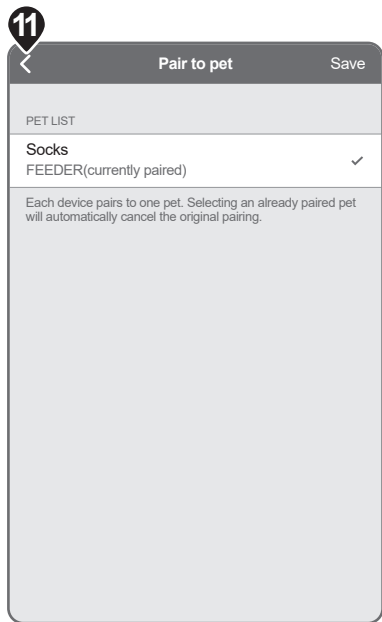

11. Tap **Back** (<) to return to the Device Menu.

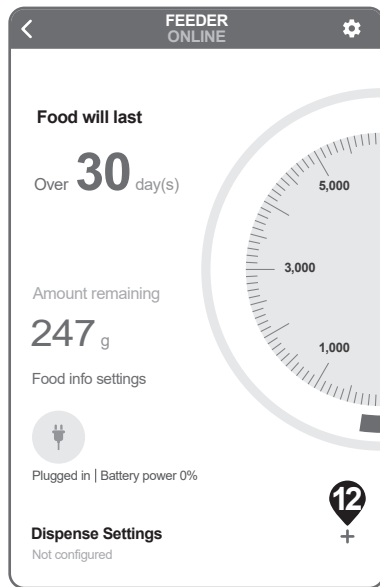

12. In Dispense Settings, tap (+).

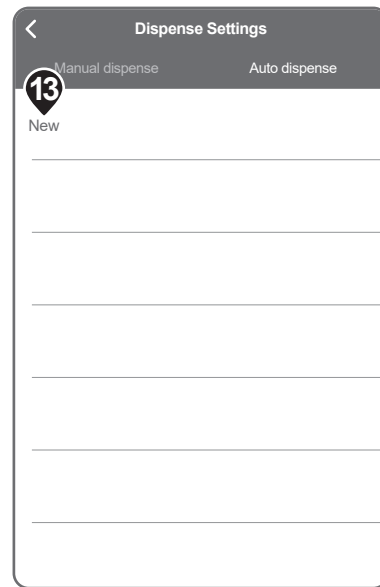

13. In Dispense Settings, tap **New**.

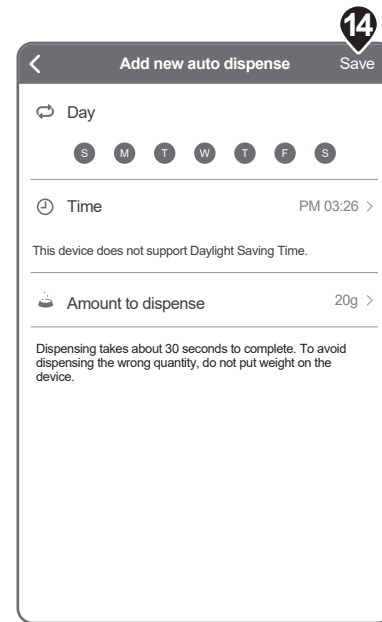

14. To define the dispense schedule, tap the Day, the Time, and the Amount to dispense (grams). Tap **Save**.

Advanced Settings

Device Menu



Food will last:

Indicates the remaining number of days for the food supply.

Amount remaining:

Indicates the remaining amount in grams for the current food supply.

Battery (🔌):

Indicates power source and remaining battery life.

Dispense Settings:

See “Setting Up a Device” for more information.

Dispense History:

Tap to view a history of the dispensed schedule.

Device Settings

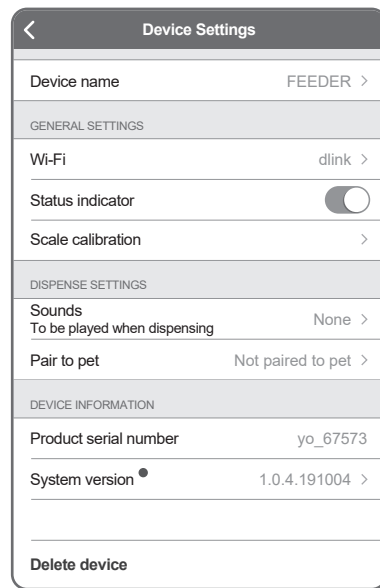

Device name:

Tap to customize the device name.

Wi-Fi:

Tap to configure Wi-Fi settings. The Bluetooth on the paired device must be enabled.

Status indicator:

Tap to enable or disable the device status LED.

Scale calibration:

See “Setting Up a Device” for device calibration.

Sounds:

Tap to define the audible notification and volume level (Options: None, cat meowing, dog barking, bird chirping, custom sound).

Pair to pet:

Tap to view paired and available pets.

Product serial number:

Displays device serial number.

System version:

Displays device firmware version.

Delete device:

Tap to delete device from app.

Pet Menu

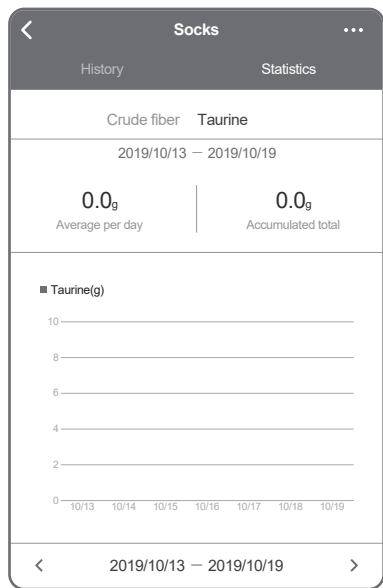

History:

Tap a date to view food dispensed information.

Statistics:

Tap to view statistical information based on: times fed, total portions, calories, crude protein, crude fat, crude fiber, taurine.

Edit (⋮):

Tap to edit or delete the pet profile.

User Profile

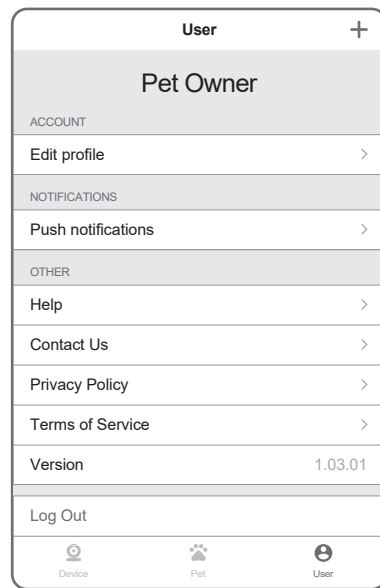

Edit profile:

Tap to edit the profile name, country/region. Email is defined through login process.

Change password:

Tap to edit the password (local profiles only).

Push notifications:

Tap to enable or disable: battery power lower than 20%, switching to battery power, dispense failure results, food running out notification (2 days prior), complete missing food details notification, and other announcements. Tap Save to confirm settings.

Help:

Tap to view a summary of tips and support information.

Contact Us:

Tap to submit an Email to Pawbo.

Private Policy:

Tap to read the privacy policy for use with the app.

Terms of Service:

Tap to read the Pawbo Website Terms of Service.

Version:

Displays the current app version.

Log Out:

Tap to log the current profile out.

Note: All define data will be removed from the smart phone.

Manual Feeding

Crunchy

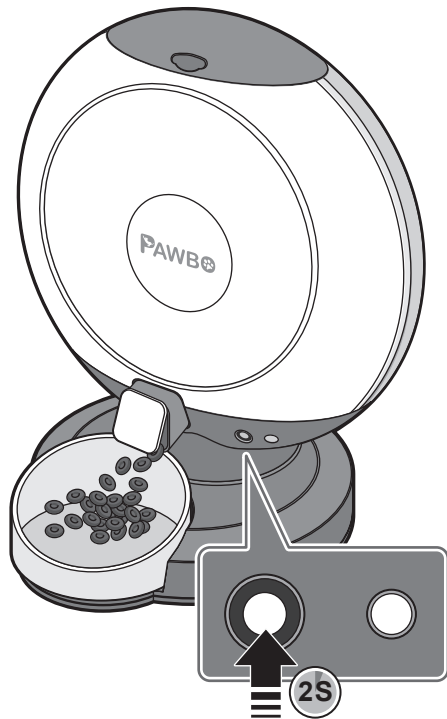

APP

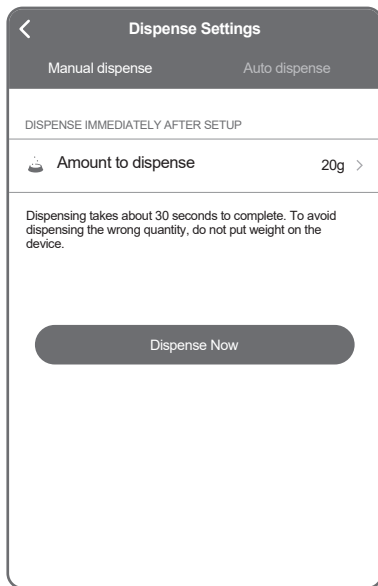

In Dispense Settings, tap (+).
Tap **Manual dispense**.
To set an amount, tap **Amount to dispense**.
Then tap **Dispense Now** to start.

Maintenance

Replacing Desiccant

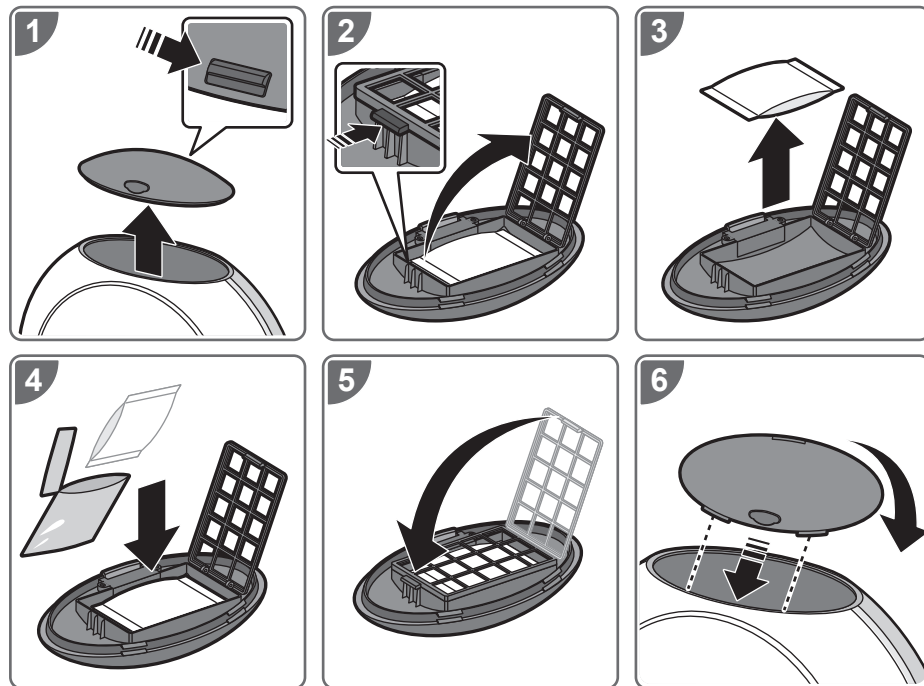

Cleaning Hopper

CAUTION:

- Power off and unplug the device before cleaning.
- Clean the unit with a damp cloth rather than a soaked cloth.
- The hopper and bowl can be removed for washing or cleaning.
- Do not immerse the base in water at any time to prevent device short-circuit.
- Wipe clean and completely dry before refilling the food.

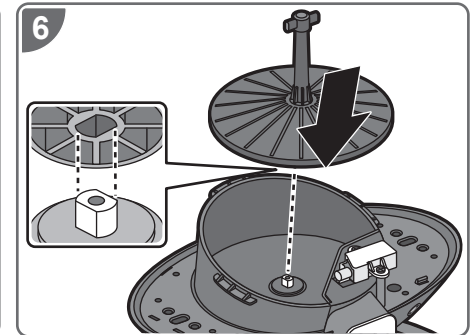
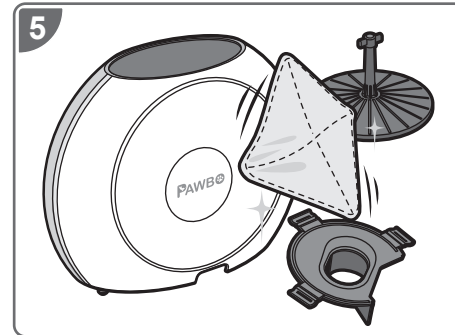
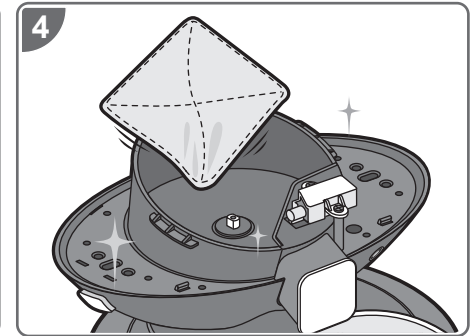
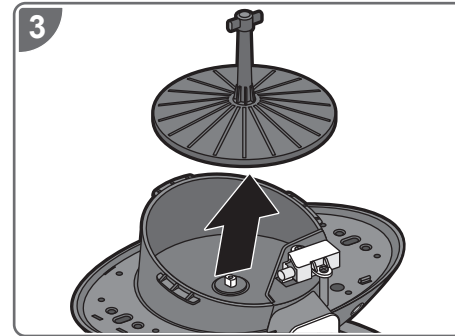
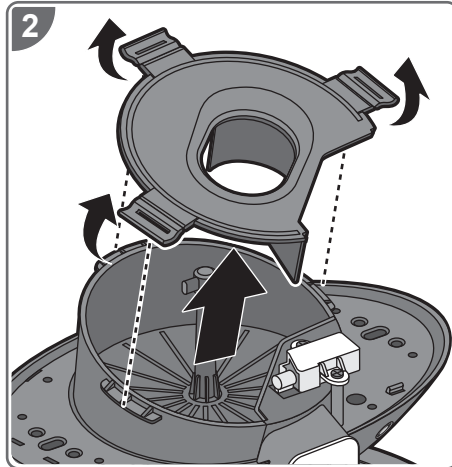
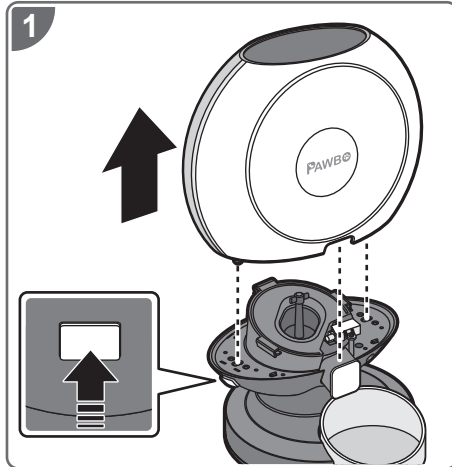

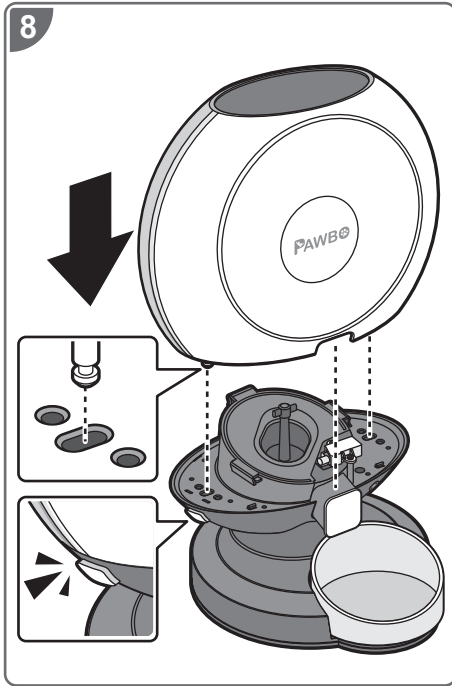
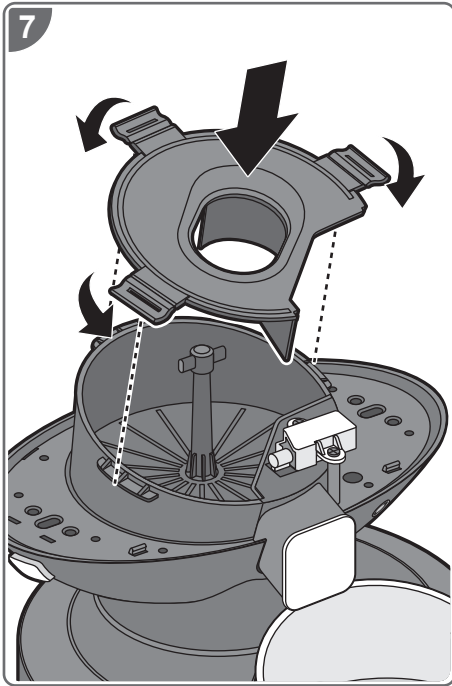

Cleaning Bowl

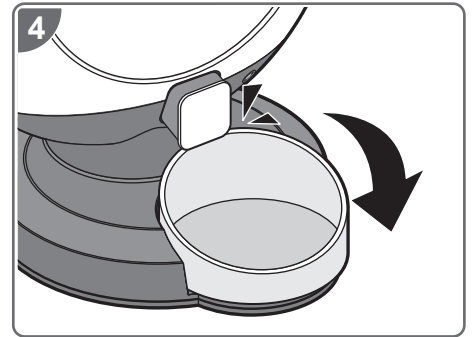
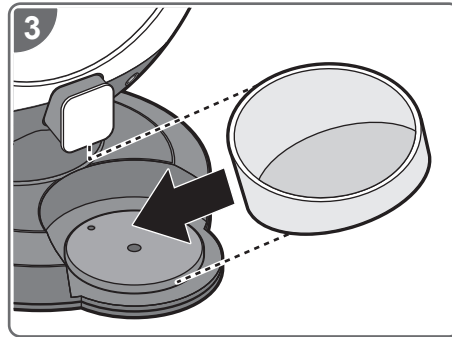
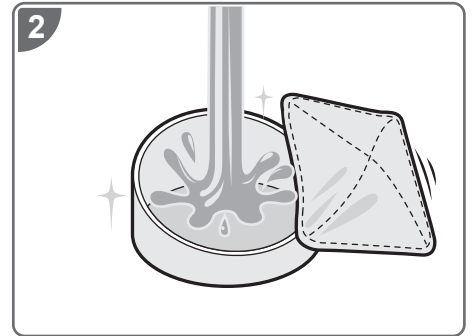
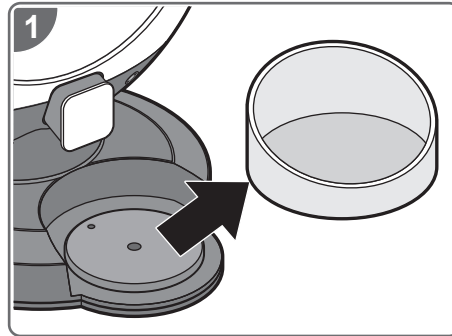

Warranty

This warranty is limited from the original date of purchase (invoice date) for 1 year period.

Any receipts or proof of purchase must be included for all repairs/services request by

Consumer. For further details, please refer to www.pawbo.com

Additional Information & Customer Service

If you require support for your Pawbo Chrunchy, please visit our website at www.pawbo.com to contact customer service (service@pawbo.com). Looking for other interesting remote interactive toys? Our website is the place to go!

PAWBO® Crunchy



快速指南

包裝內容

- Crunchy本體 (上蓋 / 餵食碗 / 乾燥劑)
- Micro USB傳輸線
- 電源轉換器

規格

- 廠牌：PAWBO
- 型號：PPC-PF01
- 容量：6公升
- 餵食碗容量：120g (4.23 oz)
- 功能鍵：餵食鍵、重置鍵、電源鍵、藍牙鍵
- LED燈號：電源 (紅色)、藍牙 (藍色)、Wi-Fi (白色)
- 重量感測器：本體 x 4、餵食碗 x 1
- Wi-Fi：2.4G (802.11 b/g/n)
- 藍牙：v4.2 BR/EDR，配有低功耗藍牙信標
- 電源轉換器：5V / 2A
- 喇叭：8Ω / 1W
- 尺寸 (寬 x 高 x 長)：361 x 422 x 328公厘 (14.2 x 16.6 x 12.9 英寸)
- 重量：2.3 kg (5.1 lbs)

設備需求

使用iOS 8.0或以上版本 /
Android 4.4或以上版本的智慧型手機

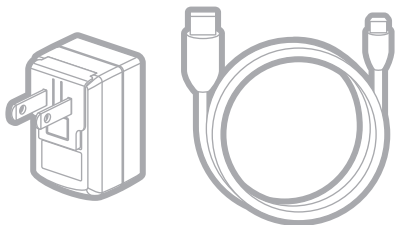

安全資訊

- 請勿將任何異物放入Crunchy本體中。
- 本產品限於室內家用，請勿在戶外使用。
- 請勿將設備用於其指定用途以外的其他用途。
- 禁止兒童於Crunchy附近玩耍。
- 除本快速指南中說明的零件外，請勿自行拆解Crunchy。
- 請勿將Crunchy安裝或存放於室外或-20°C (-4°F) 以下溫度的環境。禁止將底座浸於水中，以免損壞其電子零件。
- 請勿將Crunchy用於幼犬、幼貓、身有殘疾或無法自行進食的犬貓。
- 若設備電源線或插頭損壞、設備故障或遭破壞，請勿再行操作或使用，並應立即聯絡客服以取得進一步的指示。
- 請勿讓寵物咀嚼或吞嚥任何零件，若顧慮電源線，請自行購買並加裝電源線絕緣套 (硬塑料保護套)。
- 請勿試圖自行修理Crunchy。

重要安全資訊

- 請視需求使用合適額定值的延長線。
- 請勿將寵物餵食器用於非指定用途。非製造商建議或販售的配件可能會造成使用上的危險。
- 請勿以上蓋、本體、餵食碗或碗架將Crunchy提起，應使用雙手自底座將Crunchy提起與移動，同時保持直立。
- Crunchy限用乾糧。切勿使用濕軟或罐頭食物。
- 為避免絆倒，請時時將電源線放置於日常動線以外的地方。
- 若本產品的插頭碰水，請關閉該使用之牆上插座的電源，切勿嘗試拔插頭。
- 請於完成安裝後，詳細檢查本產品，若電源線或插頭上有水，切勿插電。
- 為降低受傷的風險，在設備使用中，應嚴密監督在旁或在附近玩耍的兒童。
- 使用電源線時，切勿將其電源線或插頭放入水或其他液體中。
- 請妥善處理所有包材。部分內容物可能裝在塑膠袋中，這些袋子可能會造成窒息，應遠離兒童與寵物。

產品介紹

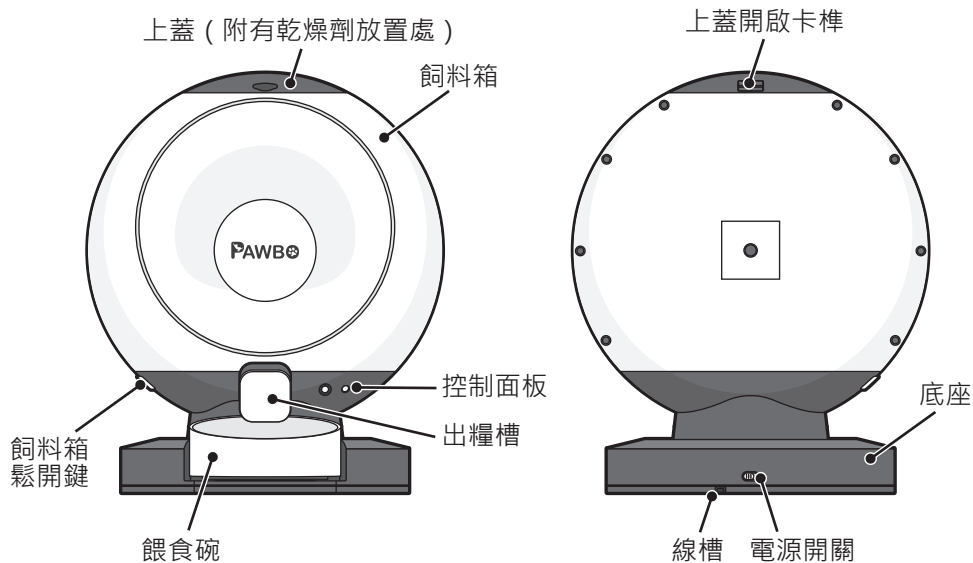

控制面板

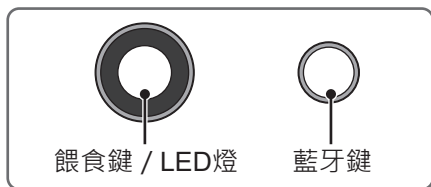

LED燈號說明

藍燈閃爍：啟動中 / 藍牙狀態 / 配對中
藍燈恆亮：藍牙已連接
白燈閃爍：Wi-Fi設置中
白燈恆亮：Wi-Fi已啟用
紅燈閃爍：重置中
紅燈恆亮：偵測到故障

腳墊 / 重量感測器

具精準重量感測器的腳墊。
若Crunchy遭受劇烈搖晃或
過大加壓時，建議清空飼料
箱並重新校正。

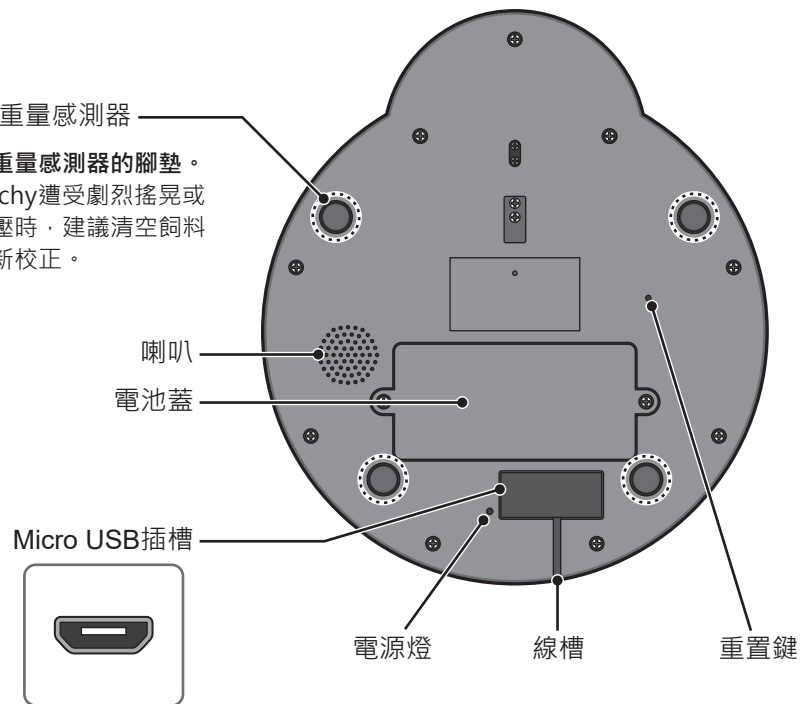

安裝

Crunchy組件

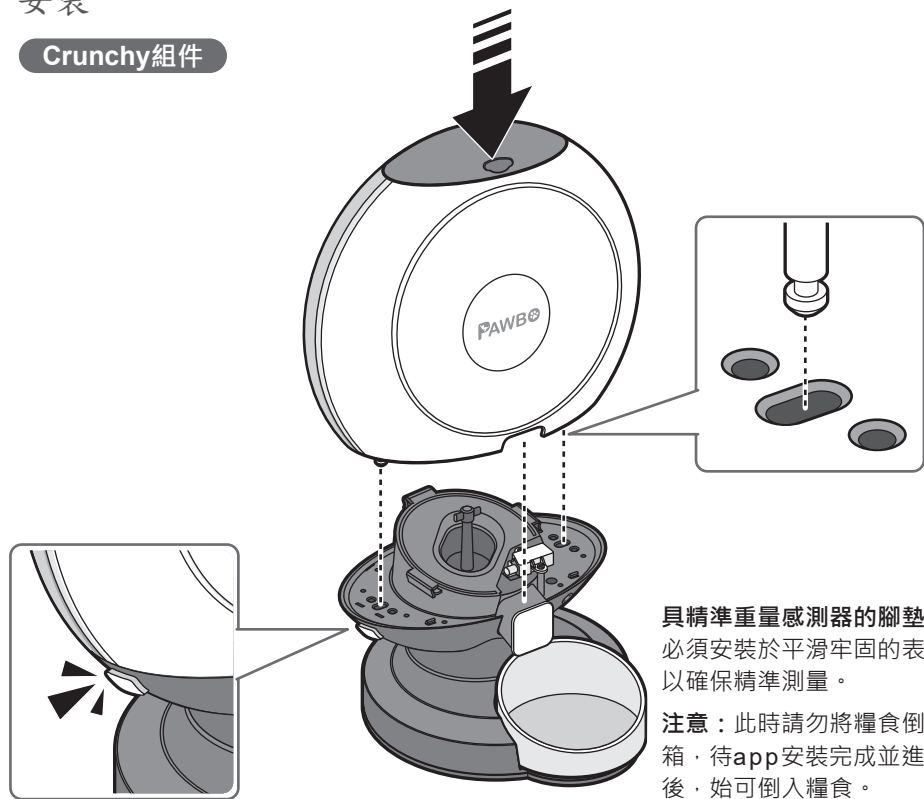

安裝備用電池

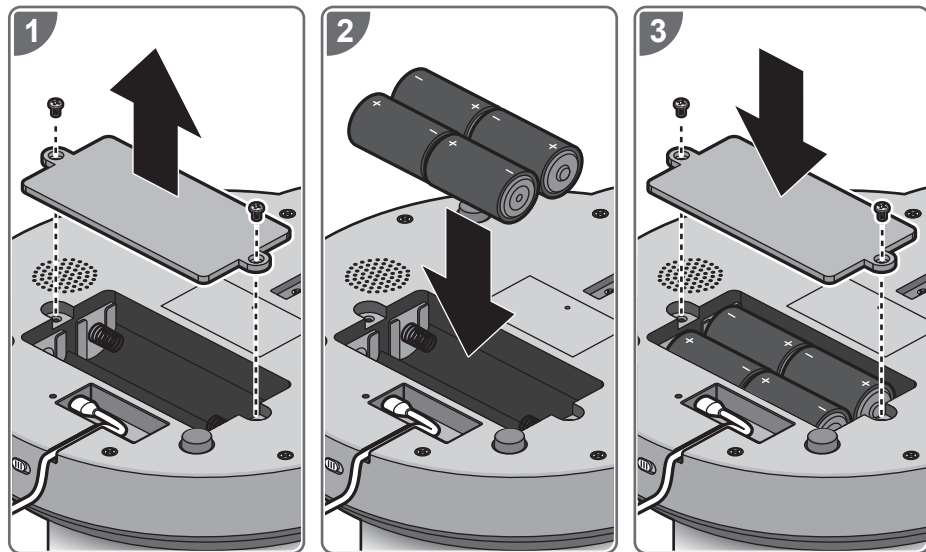

更換電池時需：

1. 先將Crunchy關機。
2. 更換電池後，將Crunchy開機並重新校正，以確保磅秤的設置為零。

安裝電源線

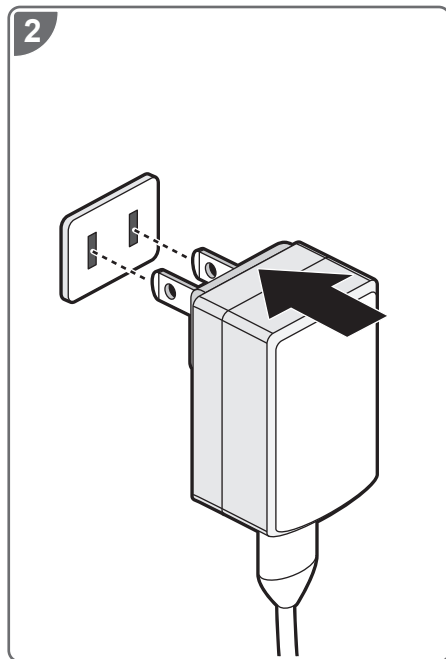
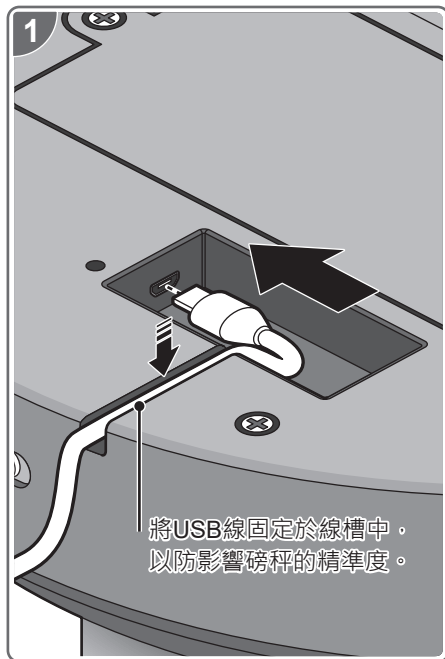

初次設定

新增裝置

1. 點擊**註冊**建立一個新的帳戶。

註冊成功後，以驗證email完成並啟用帳戶，啟用後，點擊**登入**開始使用帳戶，或點擊 (G) 或 (f) 選用雲端帳戶。

首次註冊：點擊**國家 / 區域**選擇符合項目後，點擊**OK**與**完成**以完成登入流程。



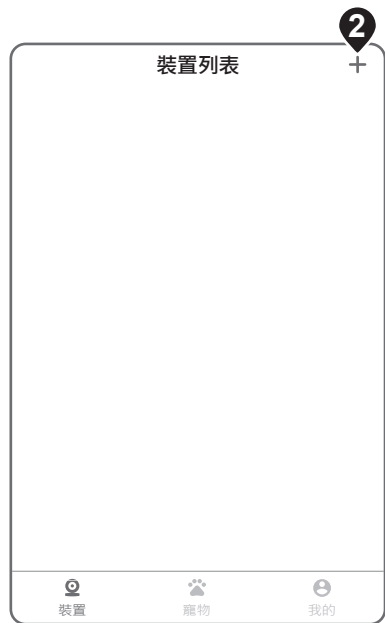

2. 點擊 (+)。

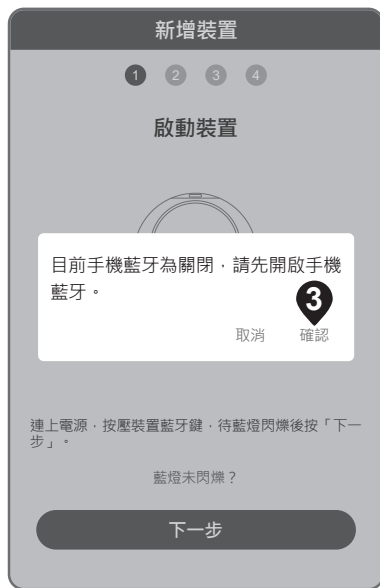

3. 開啟智慧型手機的藍牙功能。



4. 啟動Crunchy，並在LED鍵閃爍藍燈時，按下進行配對。點擊下一步進行配對。

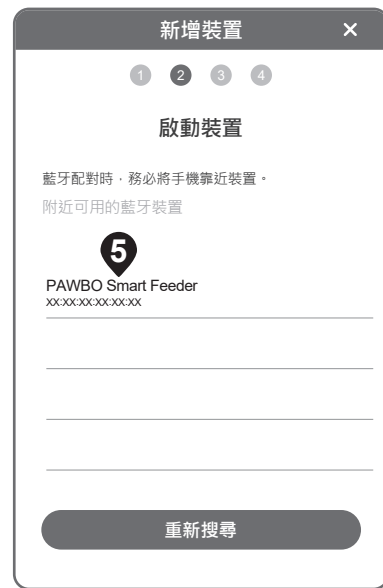

5. 點選搜尋到的Crunchy。



6. 點選搜尋到的Wi-Fi網路。



7. 配對後，該裝置即成功新增。

設定裝置

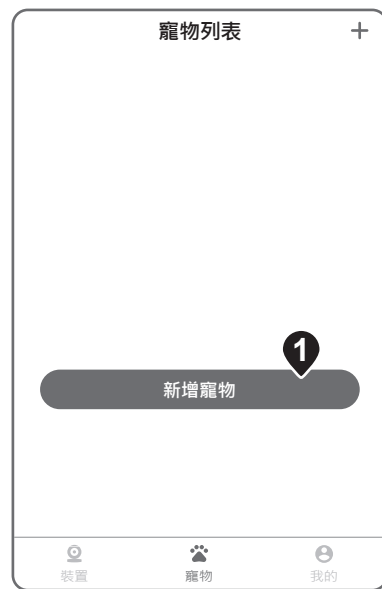

1. 從裝置列表中，點選**寵物** (🐾)，並點擊**新增寵物**。



2. 輸入寵物資訊，並點擊**儲存**後回到主選單。

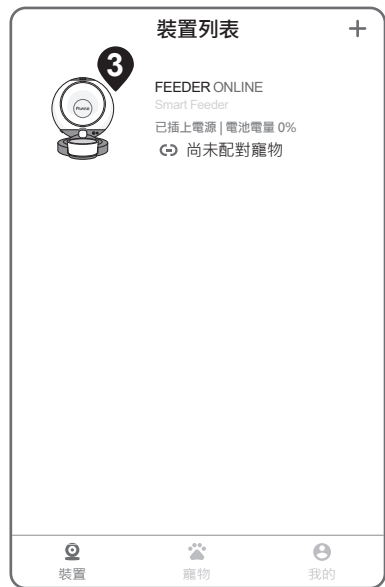

3. 從裝置列表中，點選欲設定的裝置。

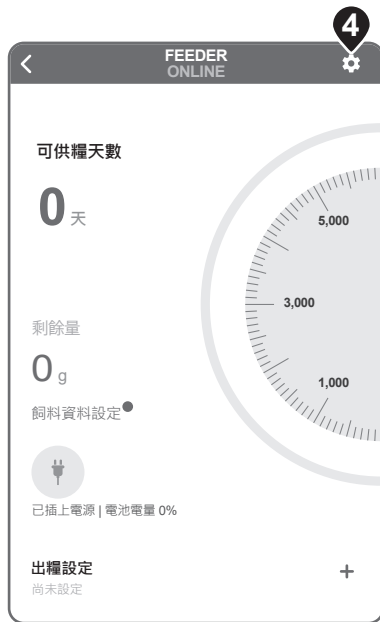

4. 點擊設定 (⚙️)。



5. 點擊磅秤校正。



6. 點擊開始校正。

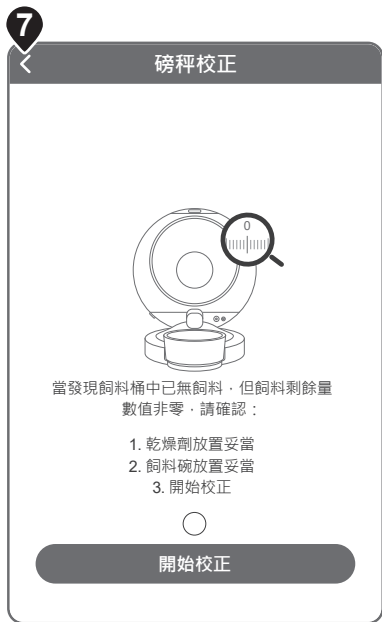

7. 點擊返回 (<) 回到裝置選單，接著將飼料箱裝滿乾糧。



8. 點擊配對寵物。

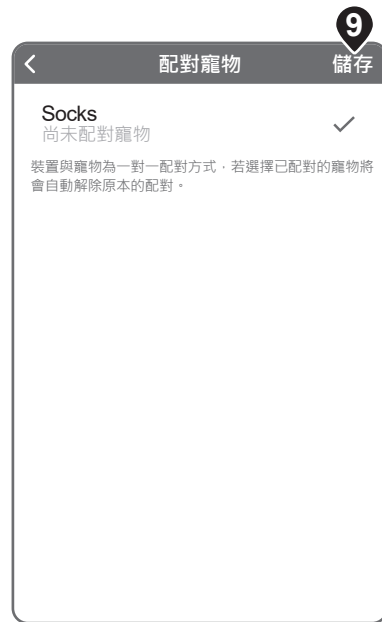

9. 從寵物列表中選取寵物，點擊儲存。



10. 點擊確認以確認配對。

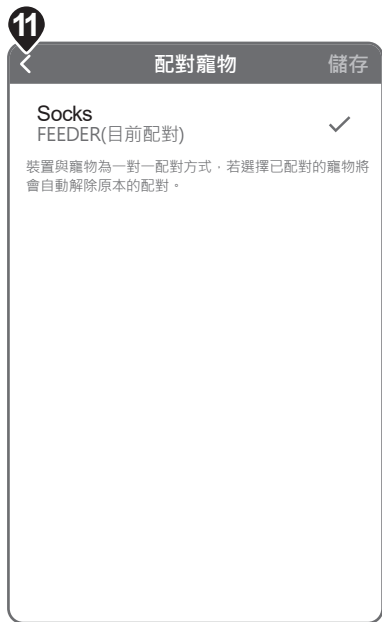

11. 點擊返回 (<) 回到裝置選單。



12. 在出糧設定中，點擊 (+)。

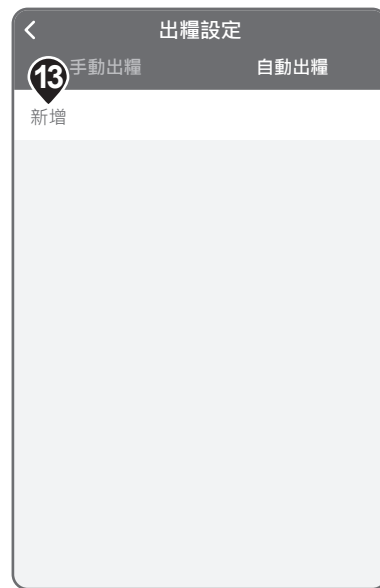

13. 在出糧設定中，點擊新增。



14. 點選星期、時間與出糧份量 (公克)，設定餵食週期，並點擊儲存。

進階設定

裝置選單



可供糧天數：

顯示乾糧可餵食的剩餘天數。

剩餘量：

顯示目前可餵食的乾糧總量（公克）。

電量（）：

顯示供電來源與電池剩餘電量。

出糧設定：

請見「設定裝置」。

出糧紀錄：

點選檢視餵食紀錄。

裝置設定項目



裝置名稱：

自定裝置名稱。

Wi-Fi：

進行無線網路設定時，需先開啟配對的藍牙裝置。

狀態燈：

點選開啟或關閉裝置的狀態指示燈。

磅秤校正：

請見「設定裝置」。

音效：

點選提醒音效（選項：None、Cat meowing、Dog barking、Bird chirping、自訂音效）與音量。

配對寵物：

瀏覽已配對或可配對的寵物。

產品序號：

顯示本產品序號。

系統版本：

顯示本產品分位版本。

刪除裝置：

點選並刪除app上的裝置。

寵物選單



記錄：

點選日期以檢視餵食資訊。

統計：

瀏覽食用次數、食用份量、熱量、粗蛋白質、粗脂肪、粗纖維、牛磺酸等的統計紀錄。

編輯(•••)：

編輯或刪除寵物資料。

帳戶設定



編輯：

編輯帳戶名稱與國家 / 區域，email則已於登入過程中設定完成。

變更密碼：

進入變更密碼。

推播通知：

點選開啟或關閉以下推播通知：電池電量低於20%、改用電池、餵食失敗紀錄、乾糧不足（用罄兩天前通知）、乾糧資訊完全遺失通知等等，完成後點擊儲存以確認設定。

說明：

提供使用祕訣與支援資訊。

連絡我們：

以email方式連絡Pawbo。

隱私權政策：

瀏覽使用app相關的隱私權政策。

服務條款：

瀏覽Pawbo網路服務政策。

版本：

顯示app目前版本號。

登出：

登出目前使用帳戶。

注意：登出後，所有定義資訊將被移除。

手動餵食

Crunchy

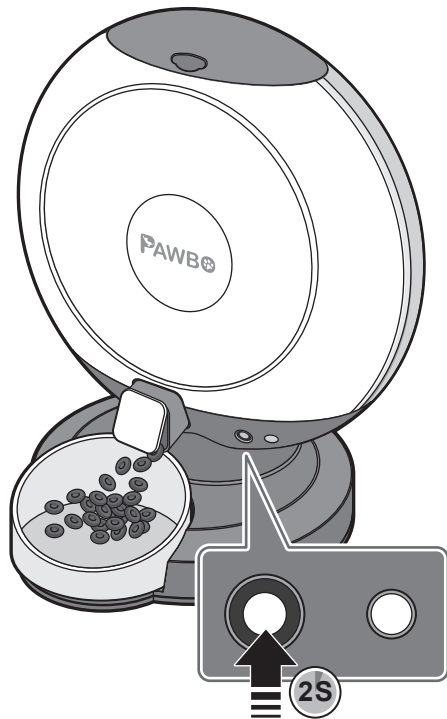

APP



在出糧設定中點擊 (+)。
點擊手動出糧，並點擊出糧份量以設定餵食量，接著點擊立即出糧以啟動手動餵食。

產品維護

更換乾燥劑

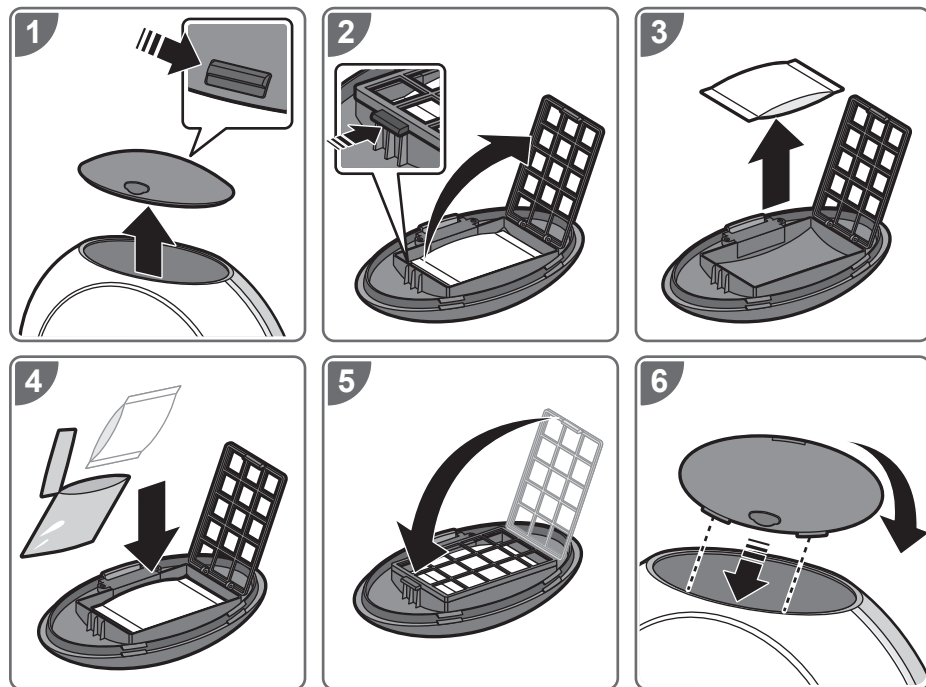

清潔飼料箱

注意：

- 在清潔之前，請關閉電源並拔除Crunchy的電源。
- 將布沾濕而不是用全濕布清潔本產品。
- 飼料箱與餵食碗可拆下進行清洗或清潔。
- 切勿將底座浸入水中，以免本產品發生短路。
- 重新裝滿乾糧之前，請擦拭乾淨並完全乾燥。

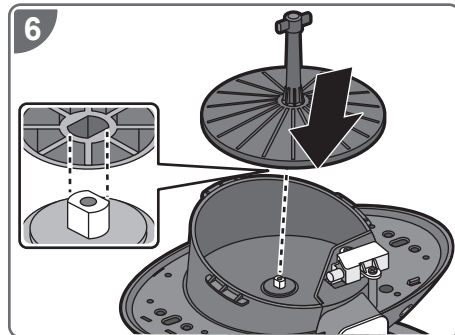
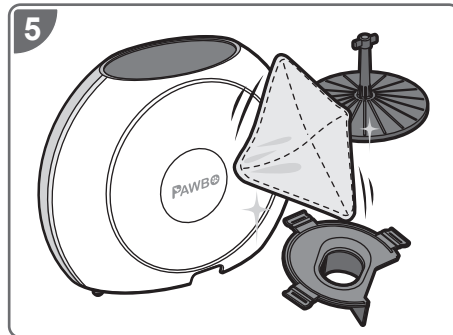
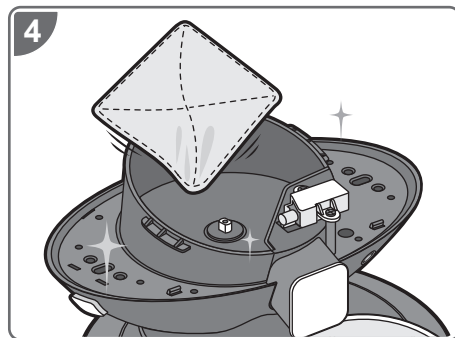
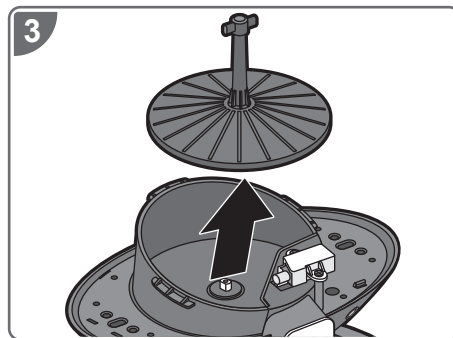
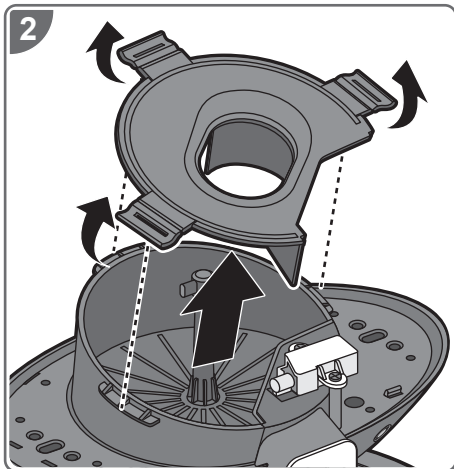
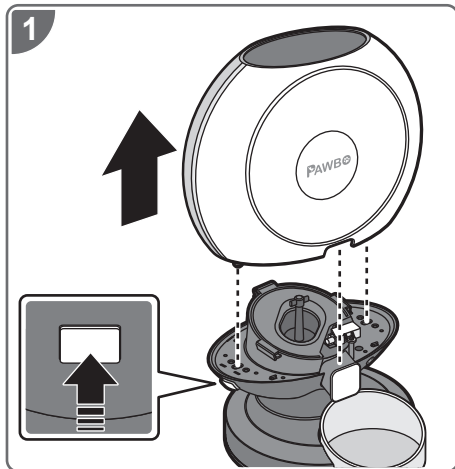

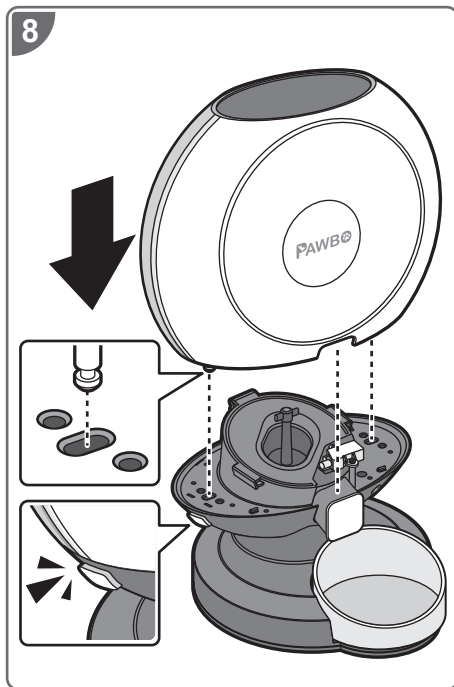
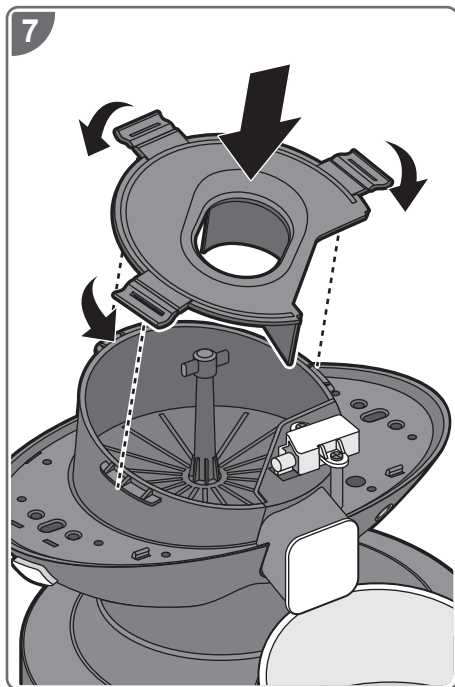

清潔餵食碗

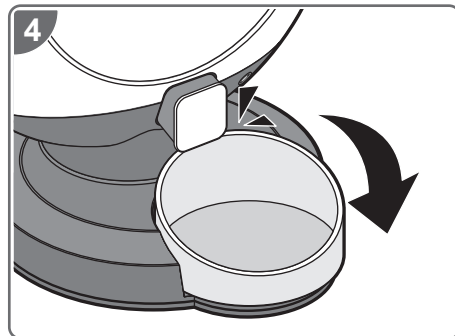
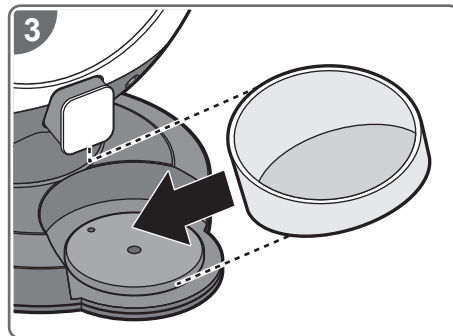
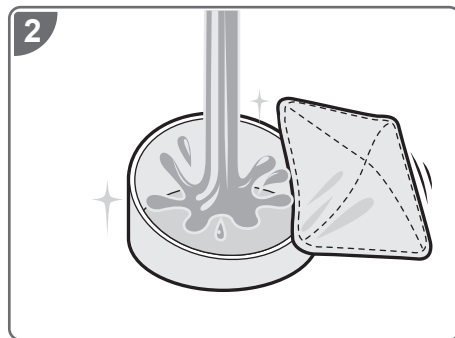
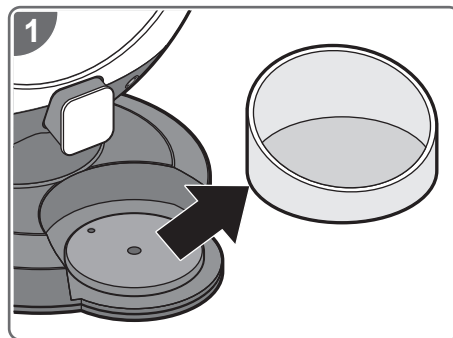

保固資訊

本保固自購買的原始日期 (發票日期) 開始為期一年。
所有消費者要求之維修 / 服務皆需提供收據或購買證明。
相關資訊請詳閱www.pawbo.com。

其他資訊與客戶服務

若您有需要Pawbo Chrunchy的相關支援資訊，
請至www.pawbo.com與客服聯繫 (service@pawbo.com)。
正在尋找其他有趣的遙控互動型玩具嗎？來我們的網站就對了！



CE Declaration of Conformity

We,

Pawbo Incorporated
6F., No.68, Ruiguang Rd., Neihu Dist., Taipei City 114, Taiwan
Contact Person: Mr. Hsiao Hung Chin, e-mail: dan.x@pawbo.com

And,

Acer Italy s.r.l.
Via Lepetit, 40, 20020 Lainate (MI) Italy
Tel: +39-02-939-921 ,Fax: +39-02 9399-2913 ,www.acer.it

Declare under our own responsibility that the product:

Product: Pawbo Crunchy
Trade Name: PAWBO

Regulation Model Number	PPC-PF01
-------------------------	----------

We hereby declare above product is in compliance with the essential requirements and other relevant Union harmonization legislation of below Directives.

References to the relevant harmonized standards used or references to the other technical specifications in relation to which conformity is declared:

EMCD Directive : 2014/30/EU

<input checked="" type="checkbox"/> EN 55014-1:2006+A1+2009+A2:2011	<input checked="" type="checkbox"/> EN 55014-2:1997+A1:2001+A2:2008	<input checked="" type="checkbox"/> EN 61000-3-3:2013
<input checked="" type="checkbox"/> EN 61000-3-2:2014 Class A	<input checked="" type="checkbox"/> EN 301-489-1 V2.1.1	<input checked="" type="checkbox"/> EN 301-489-17 V3.1.1

RED Directive : 2014/53/EU

<input checked="" type="checkbox"/> EN 300328: V2.1.1	<input checked="" type="checkbox"/> EN 62311:2008	<input checked="" type="checkbox"/> EN 62479:2010
---	---	---

RoHS Directive: 2011/65/EU

<input checked="" type="checkbox"/> EN 50581:2012

Year to begin affixing CE marking 2018.

Daniel Xiao / Manager
Regulation, Pawbo Inc.

March, 15, 2018

Date

FCC Declaration of Conformity

Federal Communication Commission Interference Statement This device complies with Part 15 of the FCC Rules.

Operation is subject to the following two conditions:

- (1) This device may not cause harmful interference, and
- (2) this device must accept any interference received, including interference that may cause undesired operation.

The following local manufacturer/Importer is responsible

Product:	Pawbo Crunchy
Trade Name:	PAWBO
Model number:	PPC-PF01
Name of Responsible Party:	Acer America Corporation
Address of Responsible Party:	333 West San Carlos St., Suite 1500 San Jose, CA 95110, U.

IMPORTANT NOTE:

This Class B digital apparatus complies with Canadian ICES-003. Cet appareil numérique de la classe B conforme à la norme NMB-003 du Canada.

Operation is subject to the following two conditions:

- (1) this device may not cause interference, and
- (2) this device must accept any interference, including interference that may cause undesired operation of the device.

L'exploitation est autorisée aux deux conditions suivantes :

- (1) l'appareil ne doit pas produire de brouillage, et
- (2) l'utilisateur de l'appareil doit accepter tout brouillage radioélectrique subi, même si le brouillage est susceptible d'en compromettre le fonctionnement.

台灣無線設備的警告聲明

經型式認證合格之低功率射頻電機，非經許可，公司、商號或使用者均不得擅自變更頻率、加大功率或變更原設計之特性及功能。低功率射頻電機之使用不得影響飛航安全及干擾合法通信；經發現有干擾現象時，應立即停用，並改善至無干擾時方得繼續使用。前項合法通信，指依電信法規定作業之無線電通信。低功率射頻電機須忍受合法通信或工業、科學及醫療用電波輻射性電機設備之干擾。

根據 NCC 低功率電波輻射性電機管理辦法規定：

第十二條 經型式認證合格之低功率射頻電機，非經許可，公司、商號或使用者均不得擅自變更頻率、加大功率或變更原設計之特性及功能。

第十四條 低功率射頻電機之使用不得影響飛航安全及干擾合法通信；經發現有干擾現象時，應立即停用，並改善至無干擾時方得繼續使用。前項合法通信，指依電信法規定作業之無線電通信。低功率射頻電機須忍受合法通信或工業、科學及醫療用電波輻射性電機設備之干擾。

FCC Statement

This equipment has been tested and found to comply with the limits for a Class B digital device, pursuant to part 15 of the FCC Rules. These limits are designed to provide reasonable protection against harmful interference in a residential installation. This equipment generates, uses and can radiate radio frequency energy and, if not installed and used in accordance with the instructions, may cause harmful interference to radio communications. However, there is no guarantee that interference will not occur in a particular installation. If this equipment does cause harmful interference to radio or television reception, which can be determined by turning the equipment off and on, the user is encouraged to try to correct the interference by one or more of the following measures:

- Reorient or relocate the receiving antenna.
- Increase the separation between the equipment and receiver.
- Connect the equipment into an outlet on a circuit different from that to which the receiver is connected.
- Consult the dealer or an experienced radio/TV technician for help.

FCC Radiation Exposure Statement

This device complies with FCC radiation exposure limits set forth for an uncontrolled environment and it also complies with Part 15 of the FCC RF Rules. This equipment must be installed and operated in accordance with provided instructions and the antenna(s) used for this transmitter must be installed to provide a separation distance of at least 20 cm from all persons and must not be co-located or operating in conjunction with any other antenna or transmitter. End-users and installers must be provided with antenna installation instructions and consider removing the no-collocation statement. This device complies with Part 15 of the FCC Rules. Operation is subject to the following two conditions:

- (1) this device may not cause harmful interference, and
- (2) this device must accept any interference received, including interference that may cause undesired operation.

Caution!

Any changes or modifications not expressly approved by the party responsible for compliance could void the user's authority to operate the equipment.

Pawbo Inc.
Product Warranty, Garantie du produit,
ターワランティカード, 產品保固服務卡

Please retain the original purchase receipt or approval in order to protect your right of free warranty service.

Veillez conserver le reçu ou le ticket d'achat original pour assurer votre droit au service de garantie gratuite.

ワランティを受ける際には、購入日時・購入店名を明記した購入販売店の捺印が必要です。
務必保留原購買收據或是發票，以保障您的保固權益。

Serial Number, Numéro de série,
シリアル番号, 產品序號

Purchase Date, Date d'achat,
購入月日, 購買日期

Dealer stamps, Marque du revendeur,
購入販売店捺印, 經銷商蓋印處

Manufacturer: Pawbo Inc.
6F, No.68, Ruiguang Rd., Neihu Dist., Taipei City 114, Taiwan
E-mail: service@pawbo.com
<https://www.pawbo.com/us/support/>

