

30'

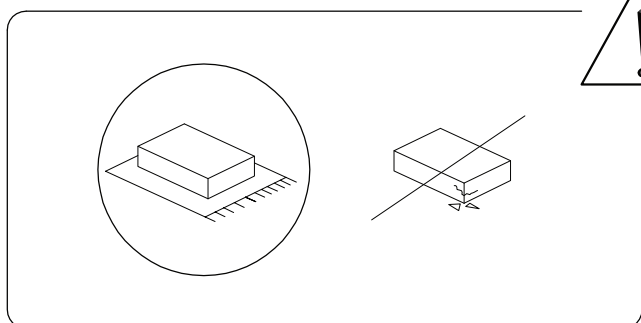

1

1/5

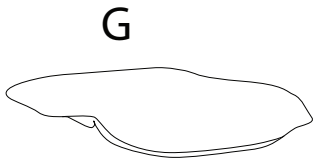

G

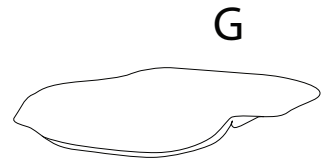

G

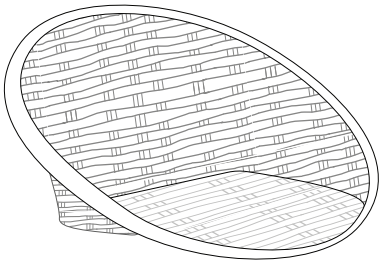

D

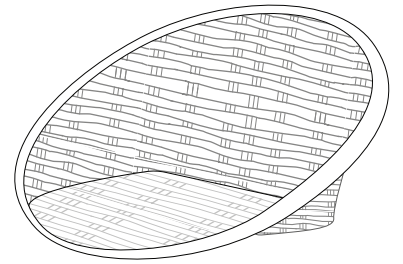

D

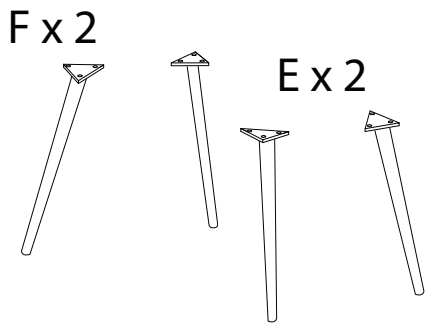

Fx2

Ex2

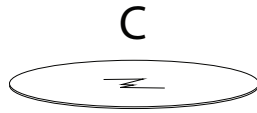

C

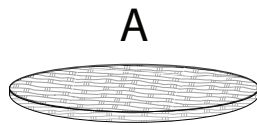

A

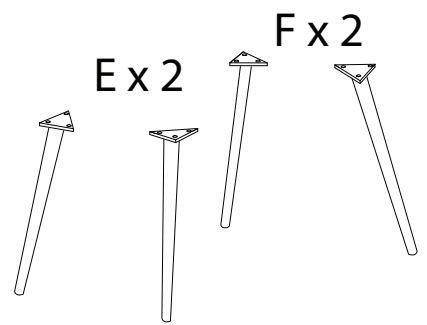



Ex2

Fx2

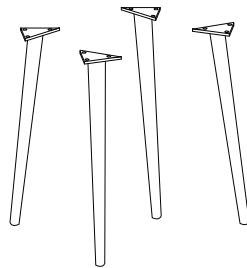
Bx4

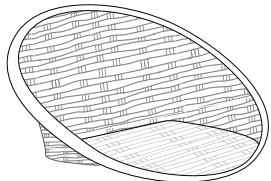

<p>A</p>  <p>x 1</p>	<p>B</p>  <p>x 4</p>	<p>C</p>  <p>x 1</p>	<p>D</p>  <p>x 2</p>
---	---	--	---

E



x 4

F



x 4

G

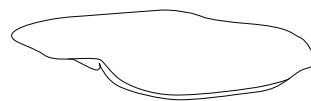

x 2

1

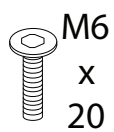

M6
x
20

x 36

2

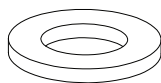

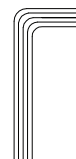

x 36

3

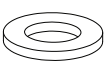
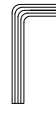
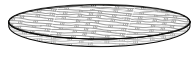

x 1

1



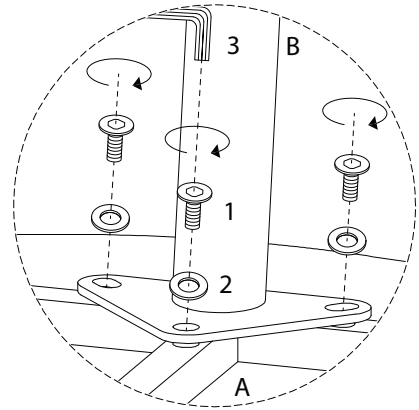
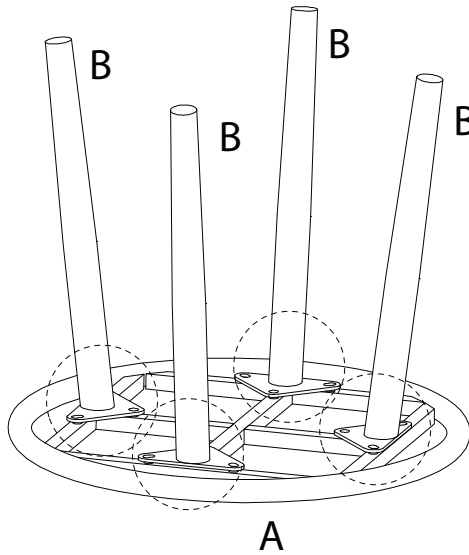

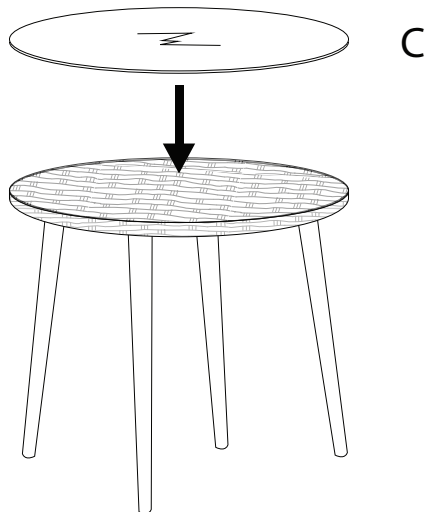
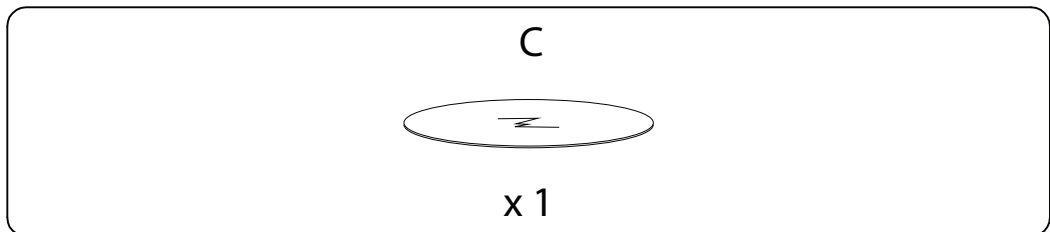

<p>1</p>  <p>M6 x 20 x 12</p>	<p>2</p>  <p>x 12</p>	<p>3</p>  <p>x 1</p>	<p>A</p>  <p>x 1</p>	<p>B</p>  <p>x 4</p>
--	--	---	---	---



2

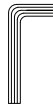

3 x 2

1  M6 x 20 x 12	2  x 12	3  x 1	D  x 1	E  x 2	F  x 2
--	--	---	--	---	---

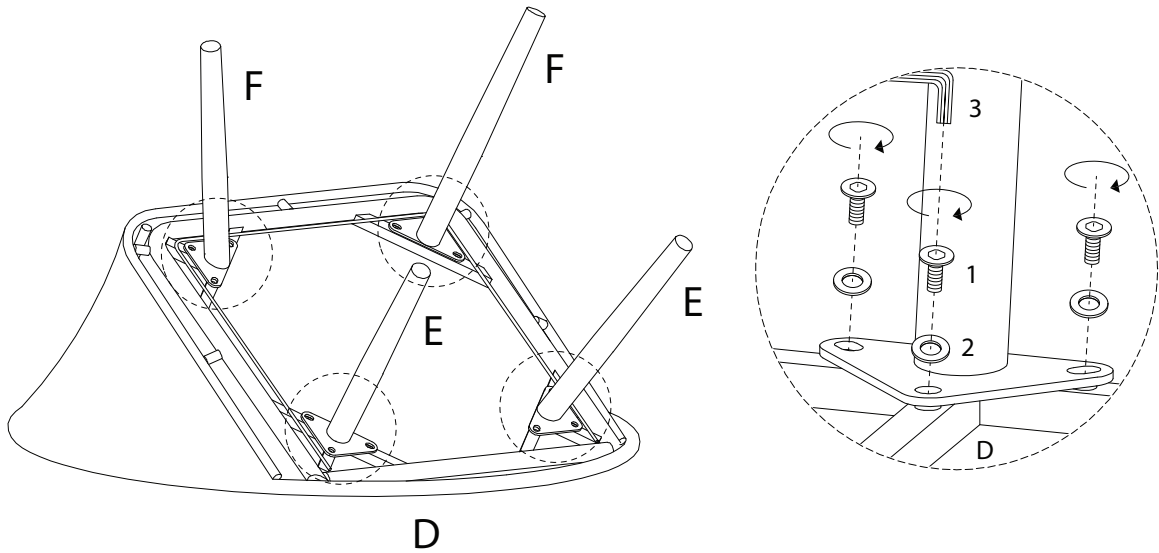

4 x 2

