

HTB7250D



Quick start guide

Always there to help you

Register your product and get support at
www.philips.com/welcome





- EN** Before using your product, read all accompanying safety information
- CS** Před použitím produktu si přečtěte doprovodné bezpečnostní informace
- DA** Læs alle medfølgende sikkerhedsoplysninger, inden du tager produktet i brug
- DE** Lesen Sie vor Verwendung dieses Produkts alle begleitenden Sicherheitsinformationen
- EL** Πριν χρησιμοποιήσετε το προϊόν, διαβάστε όλες τις παρεχόμενες πληροφορίες ασφάλειας
- ES** Antes de usar el producto, lea toda la información de seguridad adjunta
- FI** Lue kaikki turvallisuu tiedot ennen tuotteen käyttöä
- FR** Avant d'utiliser votre produit, lisez l'intégralité des consignes de sécurité jointes
- HU** A termék használatá előtt alaposan olvassa el a mellékelt biztonsági tudnivalókat
- IT** Prima di utilizzare il prodotto, leggere tutte le relative informazioni sulla sicurezza
- NL** Lees voordat u het product gaat gebruiken eerst alle bijbehorende veiligheidsinformatie
- NO** Lees voordat u het product gaat gebruiken eerst alle bijbehorende veiligheidsinformatie
- PL** Przed rozpoczęciem korzystania z produktu należy zapoznać się z informacjami dotyczącymi bezpieczeństwa
- PT** Antes de utilizar o produto, leia todas as informações de segurança que o acompanham
- RO** Înainte de a utiliza acest produs, citiți toate informațiile de siguranță care îl însoțesc
- SK** Pred použitím produktu si prečítajte všetky sprievodné bezpečnostné informácie maklumat keselamatan yang disertakan
- SV** Innan du använder produkten ska du läsa all tillhörande säkerhetsinformation
- TR** Ürününüzü kullanmadan önce ilgili tüm güvenlik bilgilerini okuyun

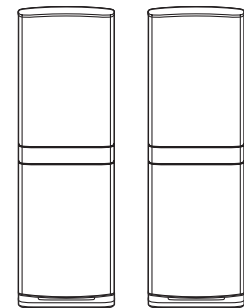
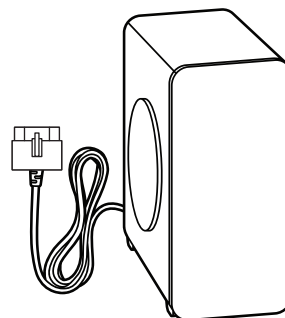
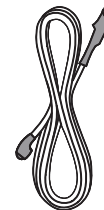
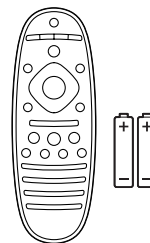
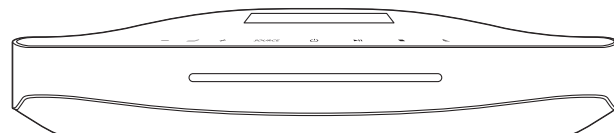
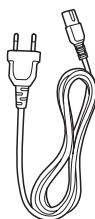
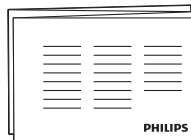
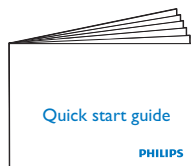

1

- EN** Connect and position the home theater
- CS** Připojení a umístění domácího kina
- DA** Tilslut og placer hjemmteateret
- DE** Verbinden und Positionieren des Home Entertainment-Systems
- EL** Τοποθετήστε και συνδέστε το home cinema.
- ES** Conexión y colocación del sistema de cine en casa
- FI** Liitä ja sijoita kotiteatteri
- FR** Connectez et positionnez le Home Cinéma.
- HU** A házimozi csatlakoztatása és elhelyezése
- IT** Collegare e posizionare l'Home Theater
- NL** De home cinema plaatsen en aansluiten
- NO** Koble til og plassere hjemmekinoanlegget
- PL** Podłączenie zestawu kina domowego i ustawianie go w odpowiedniej pozycji
- PT** Ligar e posicionar o sistema de cinema em casa
- RO** Conectați și poziționați sistemul home theater
- SK** Pripojte a umiestnite domáce kino
- SV** Anslut och placera hemmabion
- TR** Ev sinema sistemini bağlayıp konumlandırın

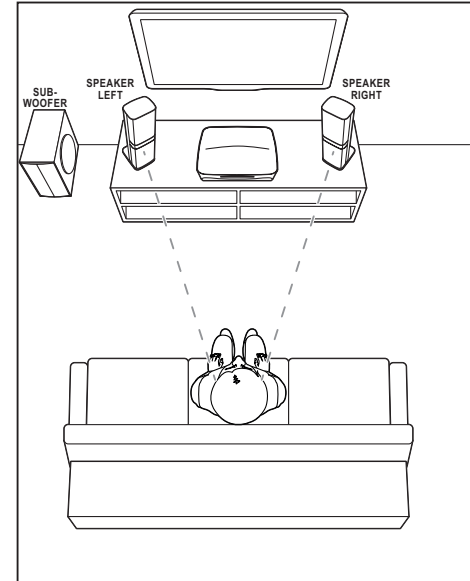
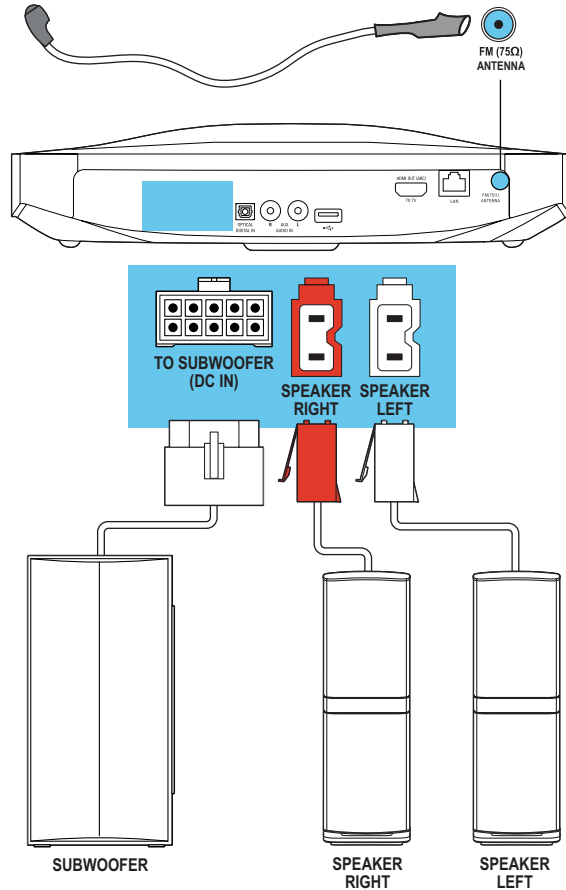

2

- EN** Connect to TV in one of these ways
- CS** Připojení k televizoru provedte jedním z následujících způsobů
- DA** Tilslut til TV på en af følgende måder
- DE** Herstellen einer Verbindung mit dem Fernseher über einer dieser Möglichkeiten
- EL** Συνδεθείτε στην τηλεόραση με έναν από τους παρακάτω τρόπους
- ES** Conexión al televisor de una de estas maneras
- FI** Liitä televisioon jommallakummalla tavalla
- FR** Connectez-vous au téléviseur via l'une de ces méthodes
- HU** Csatlakoztassa a tv-készülékhez az alábbi módok egyike szerint
- IT** Esegui il collegamento al TV in uno dei modi indicati di seguito
- NL** Maak op een van de volgende manieren verbinding met de TV
- NO** Koble til TV'en på en av følgende måter
- PL** Podłącz do telewizora przy użyciu jednej z tych metod
- PT** Ligar ao televisor de uma destas formas
- RO** Conectați-vă la televizor într-unul din aceste moduri
- SK** Pripojte zariadenie k televizoru jedným z týchto spôsobov
- SV** Anslut till TV:n på något av följande sätt
- TR** Aşağıdaki yöntemlerden biriyile TV'ye bağlanın

HDMI ARC

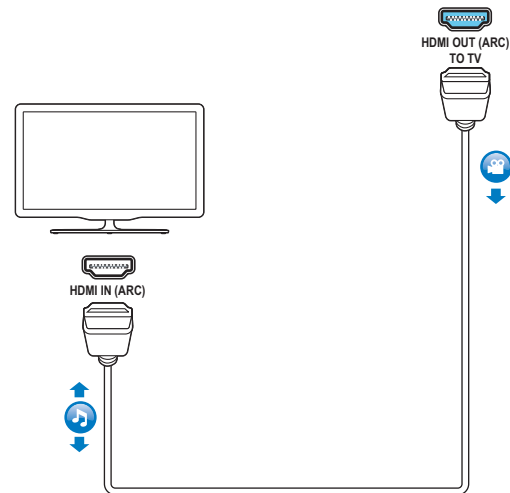
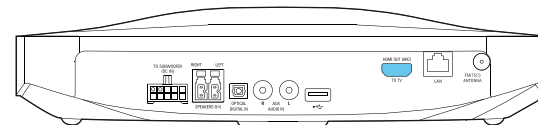

HDMI + OPTICAL

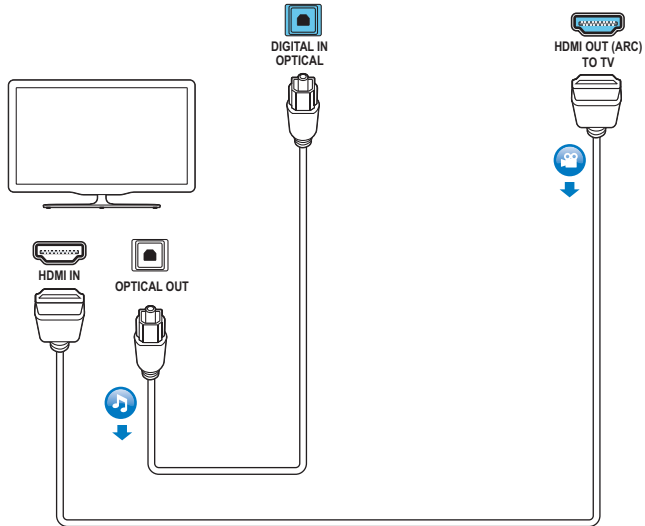
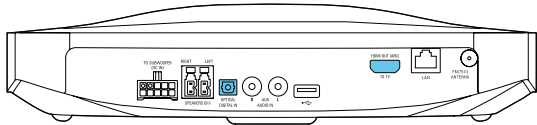
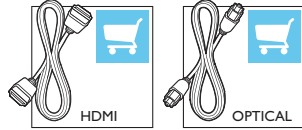

3

EN Switch on the home theater

CS Zapněte domácí kino

DA Tænd for hjemmebiografen

DE Einschalten des Home Entertainment-Systems

EL Ενεργοποιήστε το home cinema

ES Enciende el sistema de cine en casa

FI Virran kytkeminen kotiteatteriin

FR Mettre sous tension le Home Cinéma

HU A házimozi bekapcsolása

IT Accensione del sistema Home Theater

NL Schakel de home cinema in

NO Slå på hjemmekinoanlegget

PL Włączenie zestawu kina domowego

PT Ligar o sistema de cinema em casa

RO Porniți sistemul home theater

SK Zapnutie domáceho kina

SV Sätt på hemmabiosystemet

TR Ev sinemasını açın

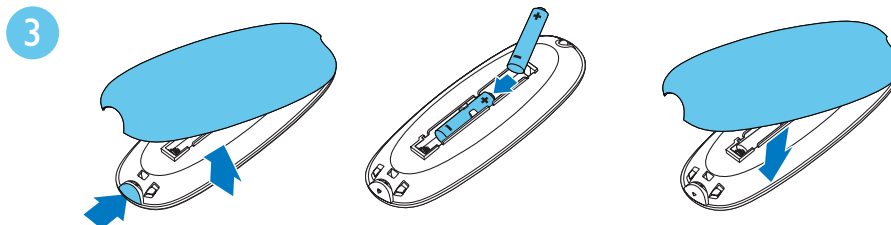
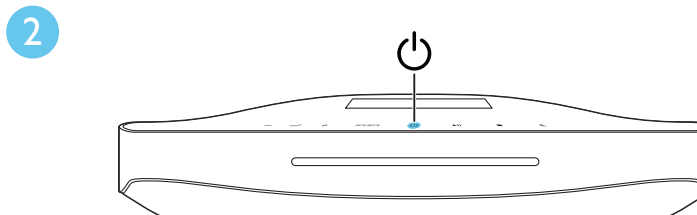
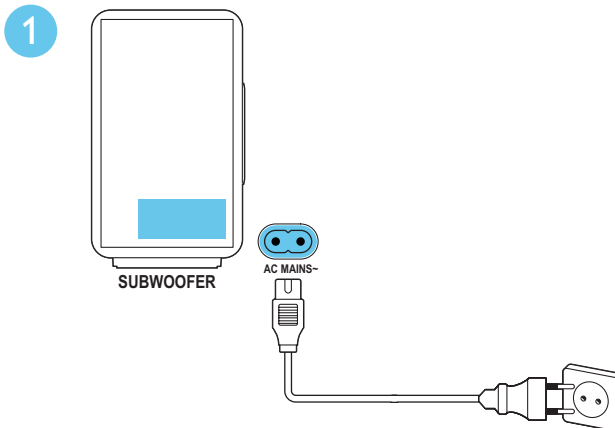

4

- EN** Complete the first time setup
- CS** Dokončili jste nastavení při prvním zapnutí
- DA** Fuldfør den indledende opsætning
- DE** Abschließen der Ersteinrichtung
- EL** Ολοκληρώστε τη ρύθμιση για πρώτη φορά
- ES** Finaliza la configuración inicial
- FI** Ensiasennuksen suorittaminen loppuun
- FR** Effectuer la configuration initiale
- HU** Az első üzembe helyezés
- IT** Completamento della configurazione iniziale
- NL** Voltooi de eerste installatie
- NO** Fullfør den første konfigureringen
- PL** Pierwsza konfiguracja
- PT** Executar a configuração inicial
- RO** Realizați prima configurare
- SK** Dokončenie prvého nastavenia
- SV** Slutför förstagångsinställningen
- TR** İlk kullanim öncesi kurulumunu tamamlayın

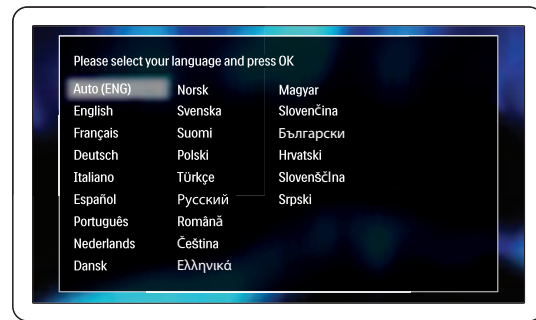
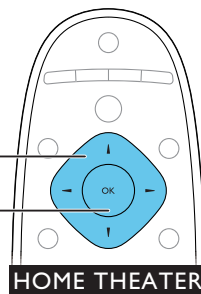
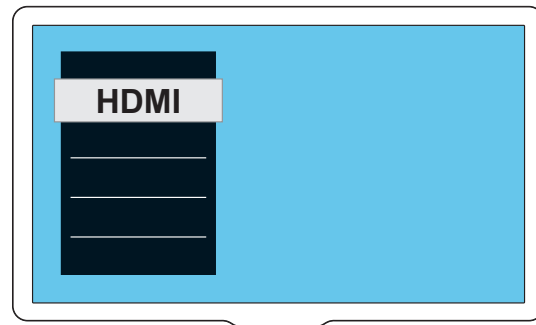
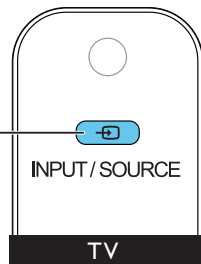

5

- EN** Need help with your product? Select Help to access the onscreen user manual
- CS** Potřebujete poradit s vaším výrobkem? Výběrem možnosti Nápověda zobrazíte elektronickou uživatelskou příručku
- DA** Har du brug for hjælp til dit produkt? Vælg Hjælp for at åbne brugervejledningen på skærmen
- DE** Benötigen Sie Hilfe mit Ihrem Produkt? Wählen Sie "Hilfe" aus, um auf das elektronische Benutzerhandbuch zuzugreifen
- EL** Χρειάζεστε βοήθεια; Επιλέξτε "Βοήθεια" για να δείτε το εγχειρίδιο χρήσης στην οθόνη
- ES** ¿Necesita ayuda con su producto? Seleccione la ayuda para acceder al manual de usuario en pantalla
- FI** Tarvitsetko apua laitteesi käytössä? Avaa käyttöopas näyttöön valitsemalla Ohje
- FR** Besoin d'aide pour votre produit ? Sélectionnez Aide pour accéder au mode d'emploi à l'écran
- HU** Segítségre van szüksége? A súgóra kattintva megtekintheti a képernyőn látható felhasználói útmutatót
- IT** Hai bisogno di aiuto per il tuo prodotto? Fai clic sul pulsante di aiuto per accedere al manuale dell'utente su schermo
- NL** Hulp nodig bij uw product? Selecteer Help om de gebruikershandleiding op het scherm te openen
- NO** Trenger du hjelp med produktet? Velg Hjelp for å få tilgang til brukerveiledningen på skjermen
- PL** Potrzebujesz pomocy w obsłudze produktu? Wybierz opcję pomocy, aby przejść do ekranowej instrukcji obsługi
- PT** Precisa de ajuda com o seu produto? Seleccione Ajuda para aceder ao manual do utilizador no ecrã
- RO** Aveți nevoie de ajutor pentru produs? Selectați Asistență pentru a accesa manualul de utilizare de pe ecran
- SK** Potrebujete pomoc k vášmu výrobku? Výberom pomôcnika spustíte návod na používanie na obrazovke
- SV** Behöver du hjälp med produkten? Öppna användarhandboken på skärmen genom att välja Hjälp
- TR** Ürünle ilgili yardıma mi ihtiyacınız var? Kullanım klavyuzuna erişmek için Yardım'a tıklayın

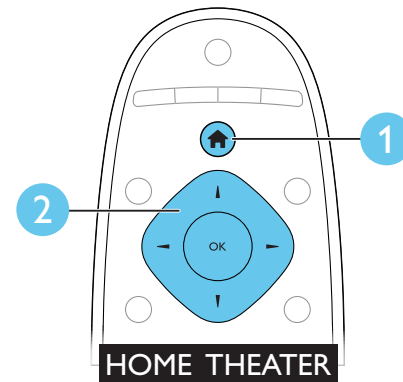

6

- EN** Use your home theater
- CS** Použití domácího kina
- DA** Brug af din hjemmebiograf
- DE** Verwenden des Home Entertainment-Systems
- EL** Χρησιμοποιήστε το home cinema
- ES** Uso del sistema de cine en casa
- FI** Kotiteatterin käyttäminen
- FR** Utiliser votre Home Cinéma
- HU** A házi mozi használat
- IT** Utilizzo del sistema Home Theater
- NL** Uw home cinema bedienen
- NO** Bruke hjemmekinoanlegget
- PL** Korzystanie z zestawu kina domowego
- PT** Utilizar o sistema de cinema em casa
- RO** Utilizați sistemul home theater
- SK** Používanie domáceho kina
- SV** Använda hemmabiosystemet
- TR** Ev sinema sisteminin kullanılması

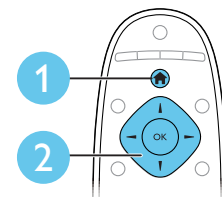
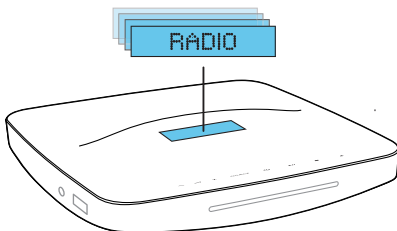
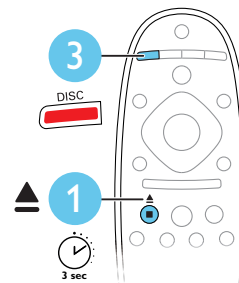
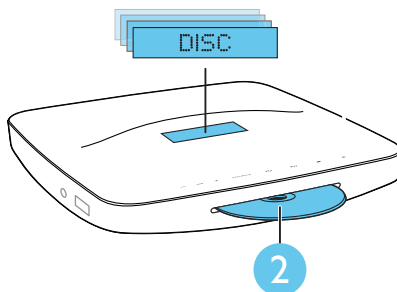

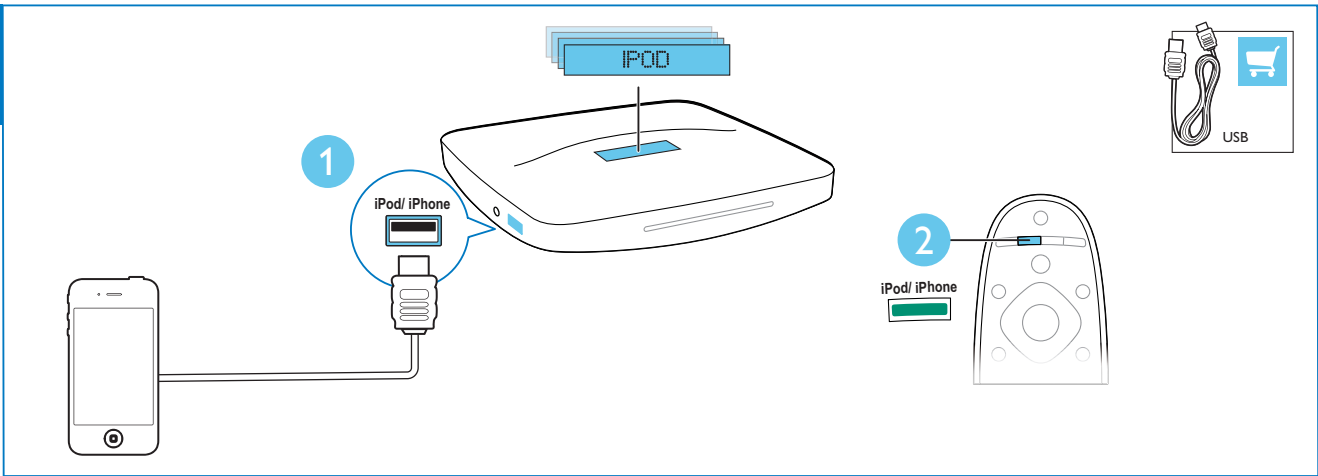
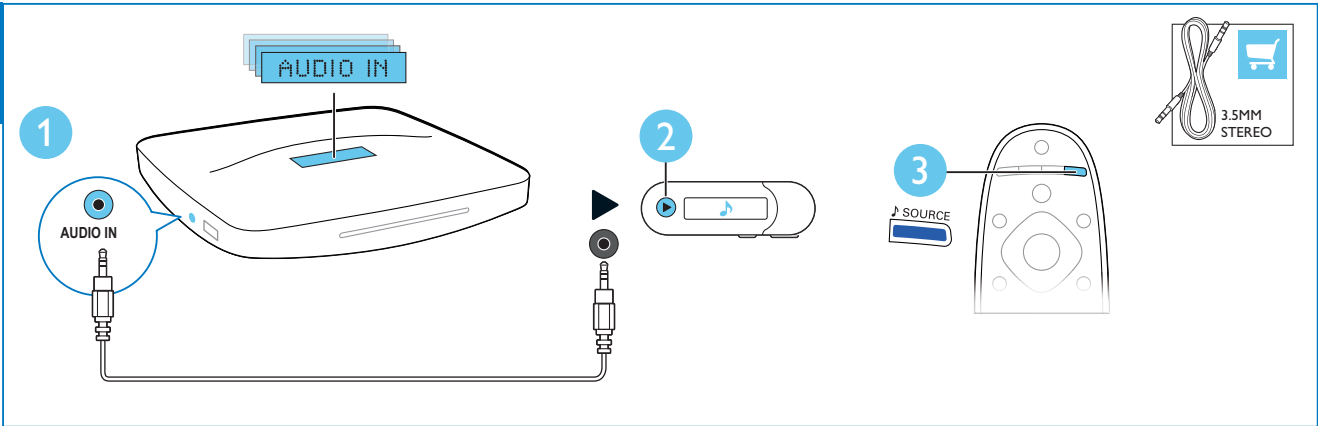

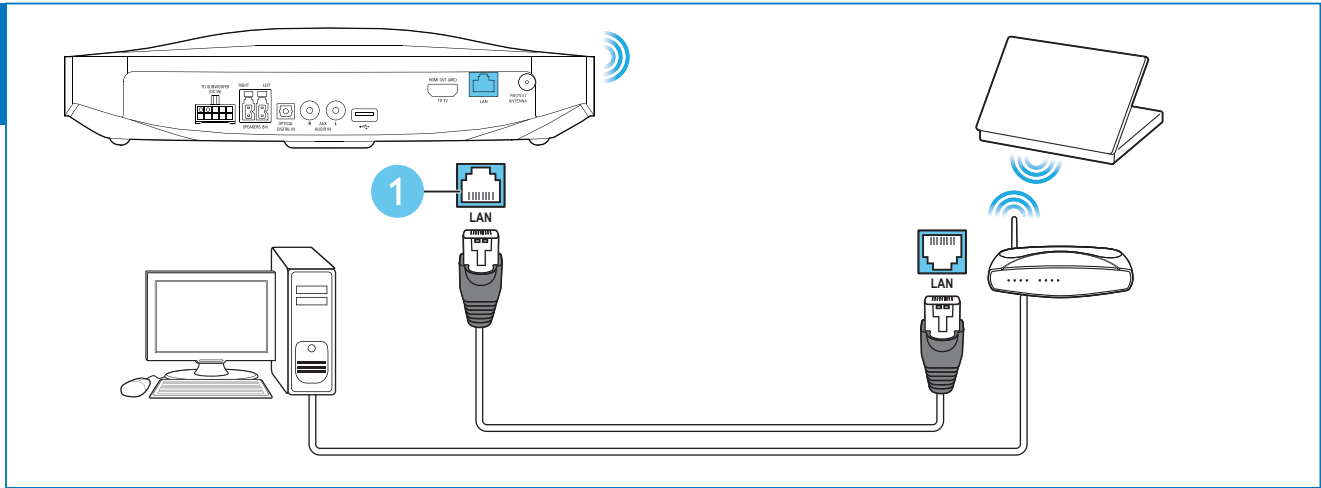
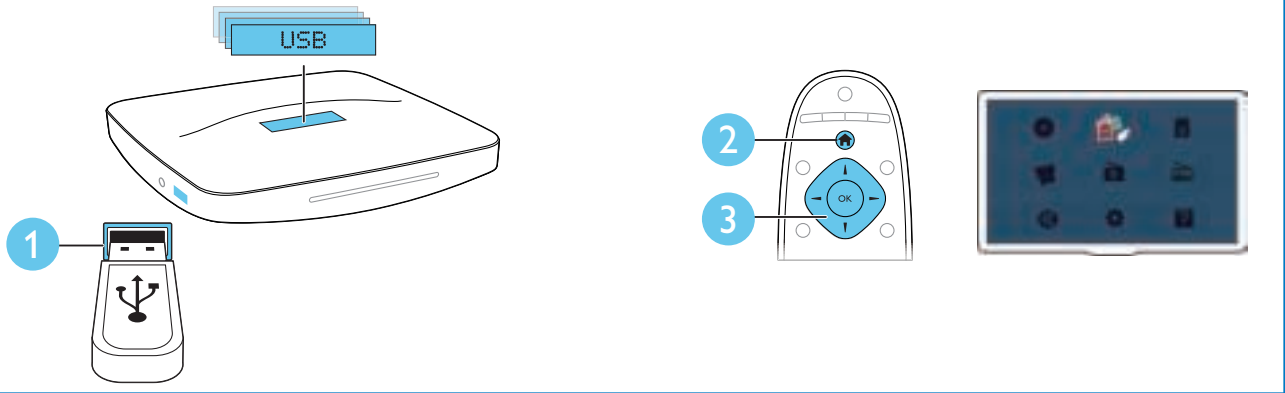



- EN** For sustainability, the user manual is not printed and available in your product as onscreen help. A printable user manual as well as product updates is available from www.philips.com/support.
- CS** Z důvodu snah o zachování trvale udržitelného rozvoje není tato uživatelská příručka vytisknuta, ale je dostupná jako elektronická nápověda v produktu. Pro tisk vhodnou verzi uživatelské příručky najdete na stránkách www.philips.com/support.
- DA** Af hensyn til bæredygtighed er denne manual ikke trykt på papir men tilgængelig i dit produkt som skærmhjælp. En printbar brugervejledning samt produktopdateringer er tilgængelige på www.philips.com/support.
- DE** Aus Nachhaltigkeitsgründen wird die Bedienungsanleitung nicht gedruckt und ist in Ihrem Produkt als Bildschirmhilfe verfügbar. Eine druckbare Bedienungsanleitung sowie Produktupdates finden Sie unter www.philips.com/support.
- EL** Για λόγους βιωσιμότητας, το εγχειρίδιο χρήστη δεν έχει τυπωθεί και παρέχεται στο προϊόν σας ως βοήθεια επί της οθόνης. Στον ιστότοπο www.philips.com/support μπορείτε να εκτυπώσετε το εγχειρίδιο χρήστη καθώς και να βρείτε ενημερώσεις για το προϊόν.
- ES** Por motivos de sostenibilidad, el manual de usuario no está en formato impreso, aunque puede verlo en formato de ayuda en pantalla en el propio producto. En www.philips.com/support, puede acceder a un manual de usuario en formato preparado para impresión y también a actualizaciones del producto.
- FI** Ympäristön suojelemiseksi käyttöopasta ei paineta, vaan se on käytettävissä tuotteessa näyttöohjeena. Painettu käyttöopas ja ajankohtaisia tietoja tuotteesta on saatavilla osoitteesta www.philips.com/support.
- FR** Dans un souci de durabilité, le manuel d'utilisation n'est pas imprimé. Il est disponible dans votre produit sous forme d'aide à l'écran. Un manuel d'utilisation imprimable et des mises à jour pour votre produit sont disponibles à la page www.philips.com/support.
- HU** A fenntarthatóság érdekében a felhasználói kézikönyv nem nyomtatott formában, hanem a képernyőn megjelenő súgóként érhető el. A kinyomtatható felhasználói kézikönyv és a termékfrissítések a www.philips.com/support webhelyen érhetők el.
- IT** Per la sostenibilità ambientale, il manuale per l'utente non è stato stampato ed è disponibile come guida su schermo fornita con il prodotto. La versione stampabile del manuale per l'utente e gli aggiornamenti per il prodotto sono disponibili all'indirizzo www.philips.com/support.
- NL** Uit milieu-overwegingen is de gebruikershandleiding niet in gedrukte vorm beschikbaar, maar als help op het scherm. U kunt zowel een zelf af te drukken handleiding als productupdates downloaden op www.philips.com/support.
- NO** Av bærekraftshensyn leveres brukerhåndboken som hjelp på skjermen og ikke i trykt form. På www.philips.com/support finner du en brukerhåndbok du kan skrive ut, samt produktopdateringer.
- PL** W trosce o środowisko niniejszy podręcznik użytkownika nie został wydrukowany, ale jest dostępny w poszczególnych produktach jako pomoc wyświetlana na ekranie. Podręcznika użytkownika do wydrukowania, jak również aktualizacje informacji o produktach są dostępne pod adresem www.philips.com/support.
- PT** Por motivos de sustentabilidade, o manual de utilizador não está disponível na versão impressa, mas sim como ajuda no ecrã. Um manual de utilizador imprimível, bem como actualizações do produto, encontra-se disponível a partir do site www.philips.com/support.
- RO** Pentru protejarea mediului înconjurător, manualul de utilizare nu a fost tipărit și este disponibil în produsul dumneavoastră ca și asistentă pe ecran. Un manual de utilizare care poate fi tipărit cât și actualizări ale produsului sunt disponibile la www.philips.com/support.
- SK** Pre lepšiu udržateľnosť sa používateľská príručka neposkytuje v tlačenej, ale v elektronickej podobe pomocníka v rámci vášho produktu. Používateľská príručka, ktorú si možno vytlačiť, ako aj aktualizácie produktu sú k dispozícii na stránke www.philips.com/support.
- SV** Användarhandboken finns av miljöhänsyn inte tryckt på papper; utan finns istället tillgänglig i din produkt som en skärmhjälp. En utskrivbar användarhandbok och produktuppdateringar finns på www.philips.com/support.
- TR** Sürdürülebilirlik sağlanması amacıyla bu kullanıcı kılavuzu basılmamış ve ürününüzde ekran yardımı olarak sağlanmıştır. Yazdırılabilir kullanıcı kılavuzu için www.philips.com/support adresini ziyaret edin.



www.philips.com/support



"Blu-ray 3D" and "Blu-ray 3D" logo are trademarks of Blu-ray Disc Association.



BONUSVIEW™
'BD LIVE' and 'BONUSVIEW' are trademarks of Blu-ray Disc Association.



'DVD Video' is a trademark of DVD Format/Logo Licensing Corporation.



Java and all other Java trademarks and logos are trademarks or registered trademarks of Sun Microsystems, Inc. in the United States and/or other countries.



Manufactured under license under U.S. Patent Nos: 5,956,674; 5,974,380; 6,226,616; 6,487,535; 7,392,195; 7,272,567; 7,333,929; 7,212,872 & other U.S. and worldwide patents issued & pending. DTS-HD, the Symbol, & DTS-HD and the Symbol together are registered trademarks & DTS-HD Master Audio | Essential is a trademark of DTS, Inc. Product includes software. © DTS, Inc. All Rights Reserved.



Manufactured under license from Dolby Laboratories. Dolby and the double-D symbol are trademarks of Dolby Laboratories.



DivX®, DivX Certified®, DivX Plus® HD and associated logos are trademarks of Rovi Corporation or its subsidiaries and are used under license.

ABOUT DIVX VIDEO: DivX® is a digital video format created by DivX, LLC, a subsidiary of Rovi Corporation. This is an official DivX Certified® device that plays DivX video. Visit divx.com for more information and software tools to convert your files into DivX videos.

ABOUT DIVX VIDEO-ON-DEMAND: This DivX Certified® device must be registered in order to play purchased DivX Video-on-Demand (VOD) movies. To obtain your registration code, locate the DivX VOD section in your device setup menu. Go to vod.divx.com for more information on how to complete your registration.

DivX Certified® to play DivX® and DivX Plus® HD (H.264/MKV) video up to 1080p HD including premium content.



The terms HDMI and HDMI High-Definition Multimedia Interface, and the HDMI Logo are trademarks or registered trademarks of HDMI Licensing LLC in the United States and other countries.



The Bluetooth® word mark and logos are registered trademarks owned by Bluetooth SIG, Inc. and any use of such marks by Philips is under license.





Non-contractual images. / Images non contractuelles. / Außervertragliche Bilder.
All registered and unregistered trademarks are property of their respective owners.
Specifications are subject to change without notice
Trademarks are the property of Koninklijke Philips Electronics
N.V. or their respective owners
2013 © Koninklijke Philips Electronics N.V. All rights reserved
www.philips.com
HTB7250D_12_QSG_V1.1

