

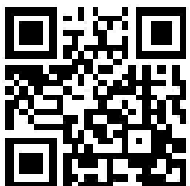

BEHIND EVERY GREAT MEAL

USER GUIDE



A commitment to:



Countries of destination:

GB - Great Britain
IE - Ireland
DE - Germany
ES - Spain

FR - France
IT - Italy
PL - Poland
NL - Netherlands

SE - Sweden
CN - China
NZ - New Zealand
AU - Australia

To contact Belling about your appliance, please call:



Customer Care Helpline

0344 815 3746

In case of difficulty within the UK



Warranty Registration

0800 952 1068

*Please call our Customer Care team for extended warranty



Spares Store
0344 815 3745



To register your appliance online:

www.belling.co.uk



To contact us by email:

gdhainfo@gdha.com



To register your appliance by mail:

Please complete the warranty card and return to the address supplied



Alternatively general, spares and service information is available from our website at: **www.belling.co.uk**

Calls are charged at the basic rate, please check with your telephone service provider for exact charges

Your new appliance comes with our **12-month guarantee**, protecting you against electrical and mechanical breakdown. To register, please complete the registration form included, register online or by phone. For full terms & conditions of the manufacturer's guarantee, please refer to the website above. In addition, you may wish to purchase an extended warranty. A leaflet explaining how to do this is included with your appliance.

Our policy is one of constant development and improvement, therefore we cannot guarantee the strict accuracy of all of our illustrations and specifications. Changes may have been made subsequent to publishing.

INTRODUCTION

Thank you for buying this British-built appliance from us.

This user guide book is designed to help you through each step of owning your new product.

Please read it carefully before you start using your appliance, as we have endeavored to answer as many questions as possible, and provide you with as much support as we can.

General information, spares and service information is available from our website.

If you should find something missing from your product or have any questions that are not covered in this user guide, please contact us (see contact information inside the front cover).

European Directives

As a producer and a supplier of cooking appliances we are committed to the protection of the environment and are in compliance with the WEEE directive. All our electric products are labelled accordingly with the crossed out wheeled bin symbol. This indicates, for disposal purposes at end of life, that these products must be taken to a recognized collection points, such as local authority sites/local recycling centres.



This appliance Complies with European Community Directives (CE) for household and similar electrical appliances and Gas appliances where applicable.

This appliance conforms to European Directive regarding Eco design requirements for energy-related products. Our policy is one of constant development and improvement, therefore we cannot guarantee the strict accuracy of all of our illustrations and specifications - changes may have been made subsequent to publishing.

Disposal of Packaging Material

The packaging materials used with this appliance can be recycled. Please dispose of the packaging materials in the appropriate container at your local waste disposal facilities.

UK ONLY GAS WARNING:

If you smell gas, Do not try to light any appliance. Do not touch any electrical switch.
Call the Gas Emergency Help line at **0800 111999**

SAFETY

WARNING

- If the hob surface is cracked, broken or shattered, switch off the appliance to avoid the possibility of electric shock and call for a service engineer's visit.
- During use the appliance becomes hot. Care should be taken to avoid touching heating elements.
- The appliance and its accessible parts become hot during use. Care should be taken to avoid touching heating elements. Children less than 8 years of age shall be kept away unless continuously supervised. This appliance can be used by children aged from 8 years and above and persons with reduced physical sensory or mental capabilities or lack of experience and knowledge if they have been given supervision or instruction concerning the use of the appliance in a safe way and understand the hazards involved. Children shall not play with the appliance. Cleaning and user maintenance shall not be made by children without supervision.
- Do not use harsh abrasive cleaners or sharp metal scrapers to clean the oven door glass since they can scratch the surface, which may result in shattering of the glass.
- Do not use a steam cleaner on any cooking range, hob or oven appliance.
- Metallic objects such as knives, forks, spoons and lids should not be placed on the hob surface since they can get hot.
- If your appliance is fitted with a lid, any spillage should be removed from the lid before opening. The hob surface should be allowed to cool before closing the lid.
- After use, switch off the hob element by its control and do not rely on the pan detector.
- To avoid electric shock, ensure that the appliance is switched off before replacing the lamp.
- The appliance is not intended to be operated by means of an external timer or separate control system.
- Unattended cooking on a hob with fat or oil can be dangerous and may result in fire.

- NEVER try to extinguish a fire with water, but switch off the appliance and then cover the flame with a lid or damp cloth.
- Danger of fire: Do not store items on the cooking surfaces.
- Only use hob guards designed by the manufacturer of the cooking appliance or indicated by the manufacturer of the appliance in the instructions for use as suitable or hob guards incorporated in the appliance. The use of inappropriate hob guards can cause accidents.
- If the cooker is placed on a base, measures have to be taken to prevent the appliance slipping from the base.
- Never put items directly on the base of the oven or cover the oven with foil, as this can cause the base element to overheat.

CAUTION

- The cooking process has to be supervised. A short term cooking process has to be supervised continuously.
- This appliance must not be installed behind a decorative door in order to avoid overheating.

- **Fire Safety Advice**

If you do have a fire in the kitchen, don't take any risks - get everyone out of your home and call the Fire Brigade.

If you have an electrical fire in the kitchen:

- Pull the plug out, or switch off the power at the fuse box - this may be enough to stop the fire immediately
- Smother the fire with a fire blanket, or use a dry powder or carbon dioxide extinguisher
- Remember: never use water on an electrical or cooking oil fire.

- **Other Safety Advice**

- Servicing should be carried out only by authorised personnel.
- Do not operate the appliance without the glass panel correctly fitted.
- Do not modify the outer panels of this appliance in any way.
- This appliance must be earthed.
- The appliance must never be disconnected from the mains supply during use, as this will seriously affect the safety and performance, particularly in relation to surface temperatures becoming hot and gas operated parts not working efficiently. The cooling fan (if fitted) is designed to run on after the control knob has been switched off.
- **GAS WARNING!** - If you smell gas: Do not try to light any appliance, Do not touch any electrical switch. Contact your local gas supplier immediately.

USING YOUR APPLIANCE

Getting to know your product

Note: Your appliance layout may differ depending on the model.

Hob

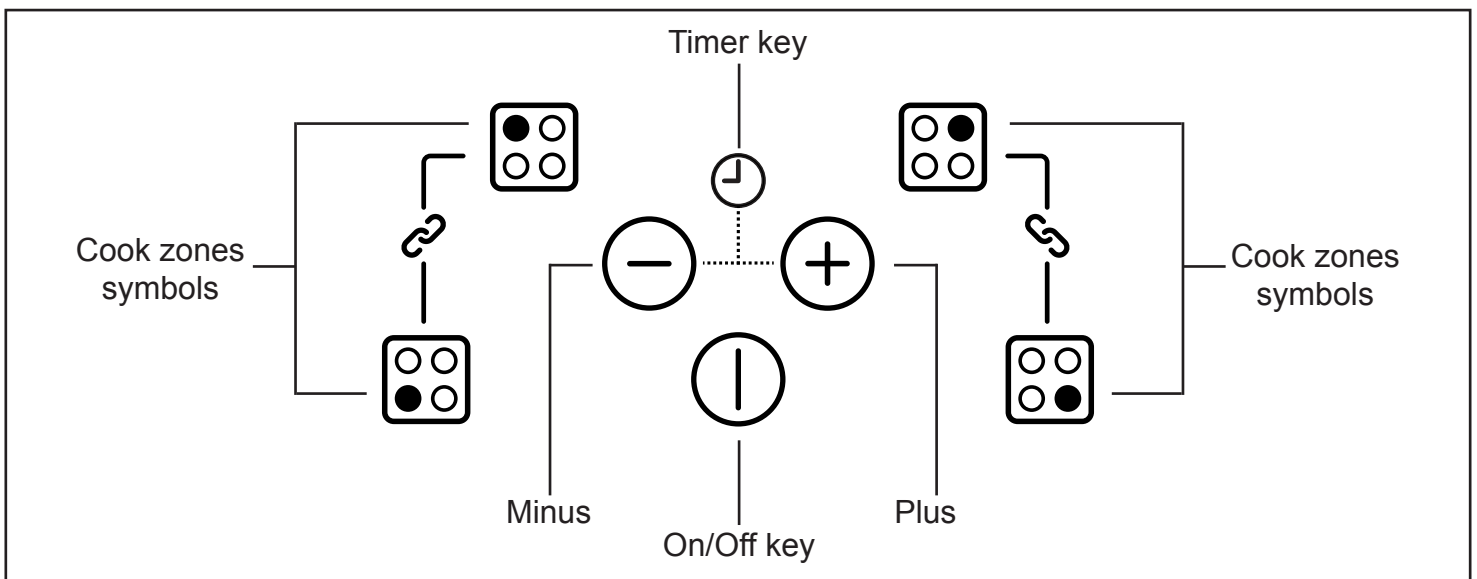
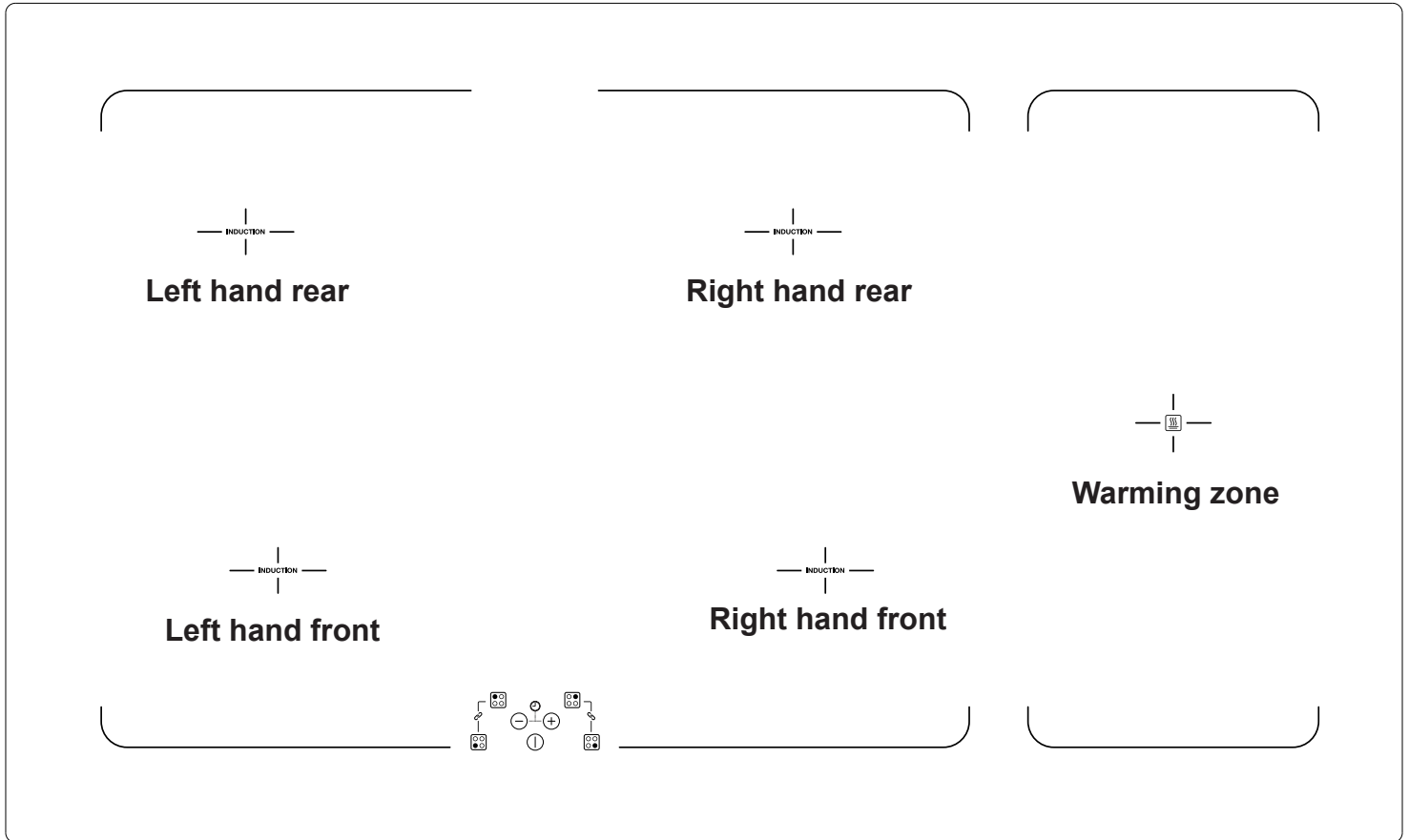

Control Panel

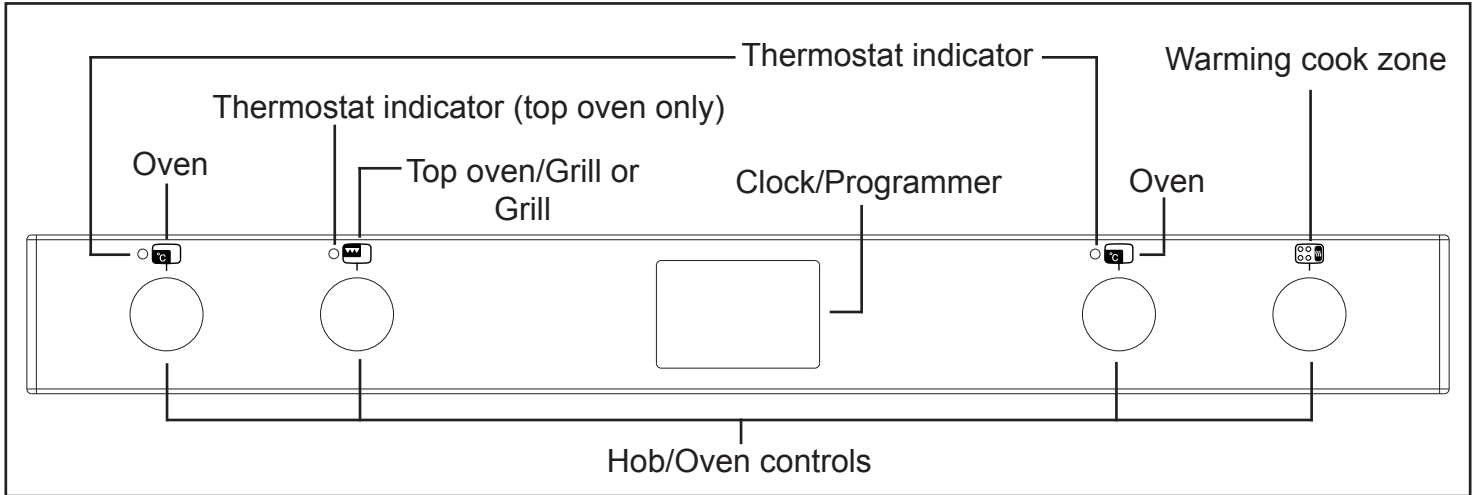

Appliance functions

Note: Your oven may not have all of the functions shown here. We recommend for best cooking results, please preheat your oven for 15 minutes and 3-5 minutes for grilling.

Do not try to slow cook using any of the other oven functions.



Intense Baking



Defrost



Base Heat with fan



Conventional Oven



Slow Cook



Fanned Oven



Fanned Grill



Low Grill



Oven Selector Control



Single Grill



Conventional Grill



Dual Grill



Top Heat



Base Heat



Lights only

Single grill

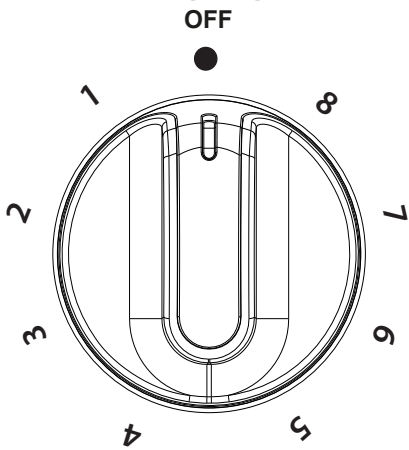

Dual Grill

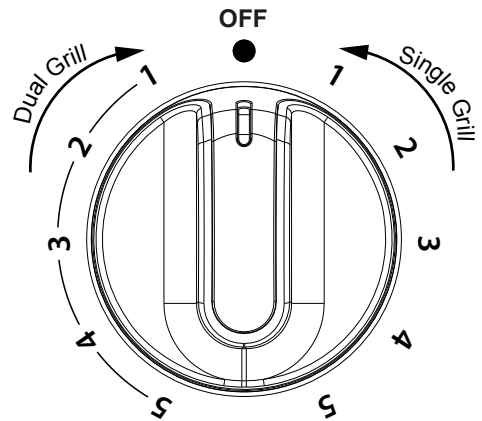

Top oven/Grill

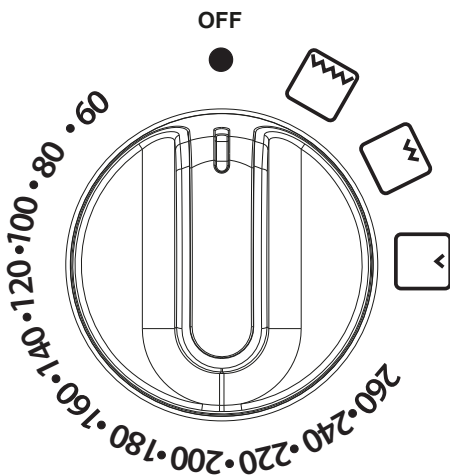

Oven

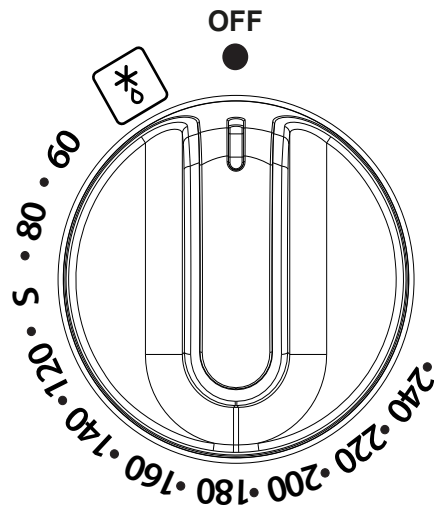

Ovens and Grill

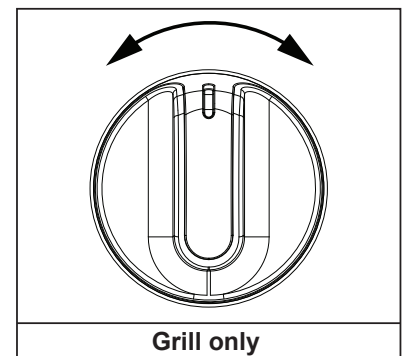
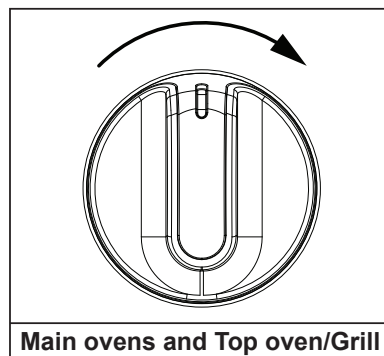
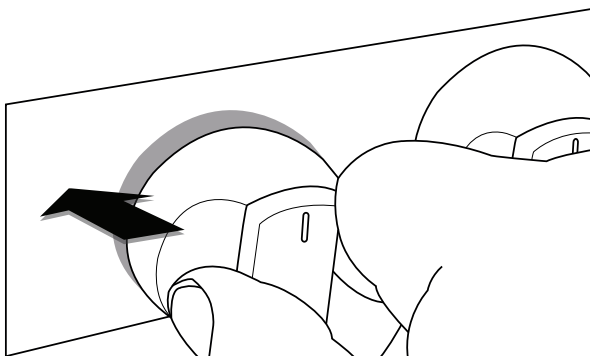

When using the top oven or main oven, the red thermostat indicator will come on until the selected temperature is reached.

When the Top oven/grill or grill is switched on, the cooling fans come on to keep the fascia and control knobs cool during cooking/grilling. The cooling fans may operate when the main ovens are in use, depending on the temperature setting. The fans may continue to operate for a period after the oven/grill has been switched off. During use the fan may cycle on and off, this is normal.

Important: Never put items directly on top of the base of the oven, or cover the oven base with foil, as this may cause the element to overheat. Always position items on the shelf.

The left hand main oven will not operate if the programmer is set to Auto, see clock/programmer section.

Grill

THE DOOR **MUST** BE OPEN WHEN THE GRILL IS USED FOR CONVENTIONAL GRILLING.

Grill pan, trivet and detachable grill pan handle

The grill trivet, inside the grill pan, can be inverted to give a high or low position, or it may be removed. The speed of grilling can be controlled by selecting a higher or lower shelf position, or adjusting the grill setting.

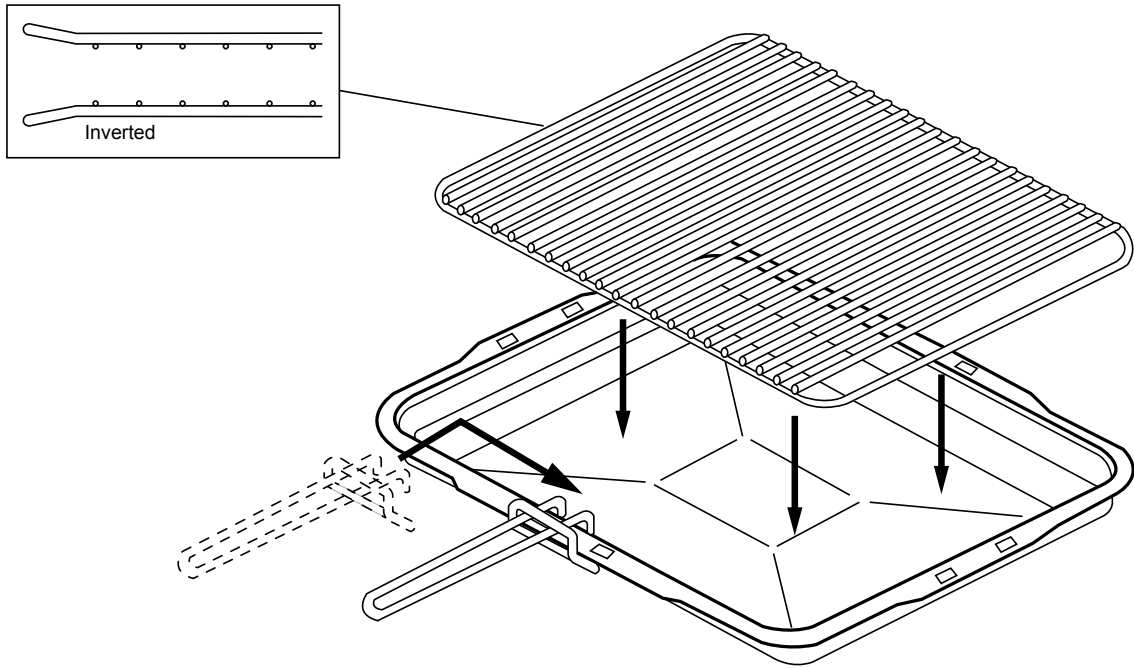



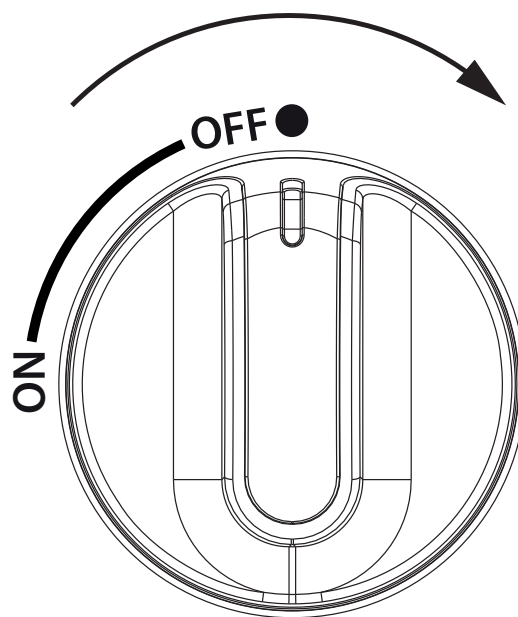



Hob warming cook zone

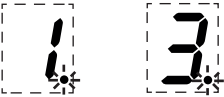

The warming function can be activated by turning the control knob to the 'On' position.

Hob Overview

Function	Description	Symbol
Power Level	Once a cook zone is selected, a power level can be set to a low or high temperature.	1-9
Cook zone timer	Once a cook zone is selected, the cook zone timer can be activated to sound after a pre-determined amount of time. When the alarm sounds and the dot begins to flash, the cook zone will turn off.	
Residual Heat	After use, the cooking surface remains hot and the residual heat symbol will be displayed. As it cools, the number of rings will reduce until they disappear from the display.	
Automatic switch off	Each cook zone is pre-set with a maximum operation time. Once this time is reached, the zone will automatically switch off. The residual heat symbol will be displayed if the surface remains hot.	N/A
Pan detection	If no pan or an unsuitable pan is detected on an activated cook zone, the pan detection symbol will be displayed. Suitable pans - cast iron, metals with magnetic properties. Non-suitable pans - copper, stainless steel, aluminium, glass, ceramic, terra-cotta.	
Booster function	The booster function temporarily increases the power to a cook zone allowing for a faster heat up time. It will deactivate automatically after 10 minutes or if a lower power level is selected.	
Bridge function	Individual cook zones can be bridged or joined together to create a larger, single controlled cook zone. By bridging the left hand front and rear zones or the right hand front and rear zones, two larger cook zones can be created.	
Recall function	While the hob is in use, if it is accidentally turned off, turn the hob back on within 6 seconds and the settings will be restored.	N/A
Child lock	Child lock can be activated to stop the hob from being accidentally turned on.	

Caution: Always ensure that induction pans remain within the marked cooking area when hot. Do not allow hob pans to rest on the user control panel at the front of the hob glass, as this will cause the controls to overheat and the appliance to temporarily shut down.

To switch on

1 Press On/Off key

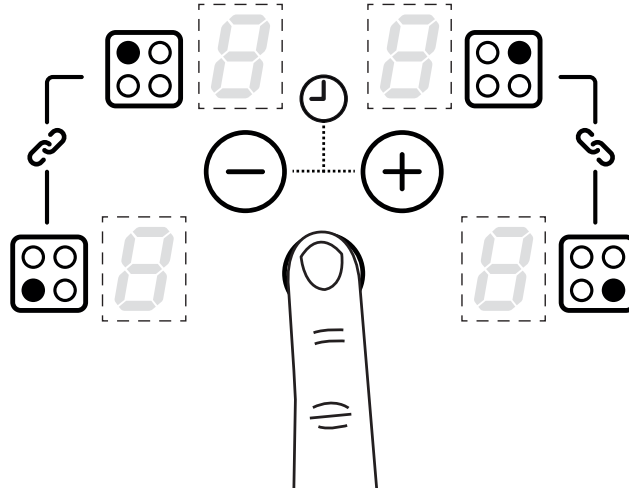

Note: If a heater is not selected in 10 seconds, the hob will turn off automatically. The hob is switched off by touching the "ON/OFF" key for 1 second. A beep sounds and all the heaters will switch off.

Switching on an individual hob cook zone

1 Choose required cook zone

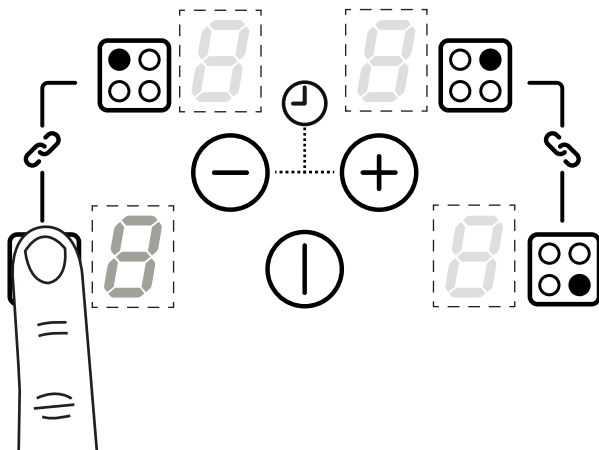

2 Set desired power level

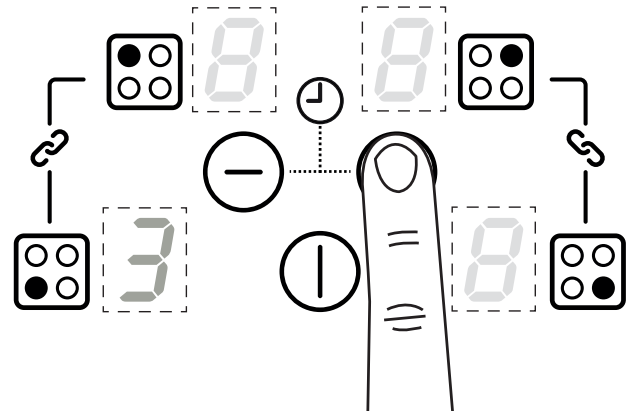

Note: Pressing the minus key first will automatically set the power level at level 9.

When the cook zone selection is finished after 10 seconds, a beep sounds and all the heater displays that were dimmed show the power levels with normal brightness.

Switching off an individual hob cook zone

1 Select a cook zone

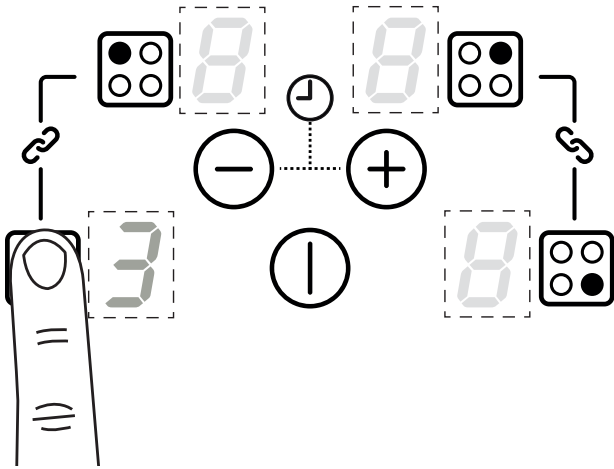

2 Press the minus button until it reaches "0"

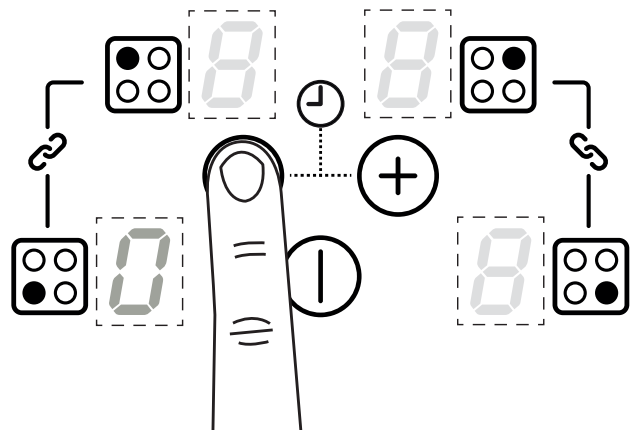

The selected cook zone will be switched off when the display shows "0".

Activating Power Boost

1 Choose required cook zone

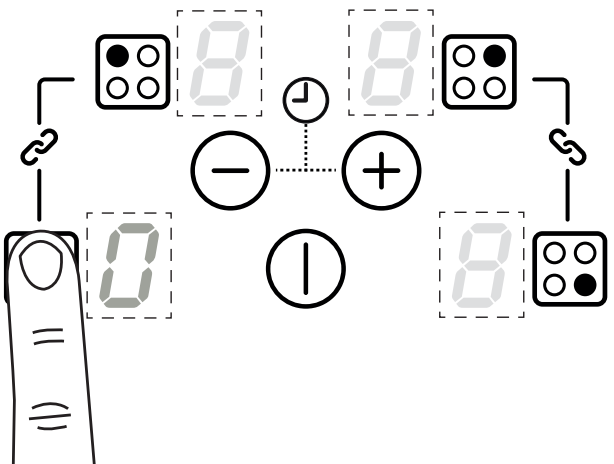

2 Press the minus key and power level 9 will appear

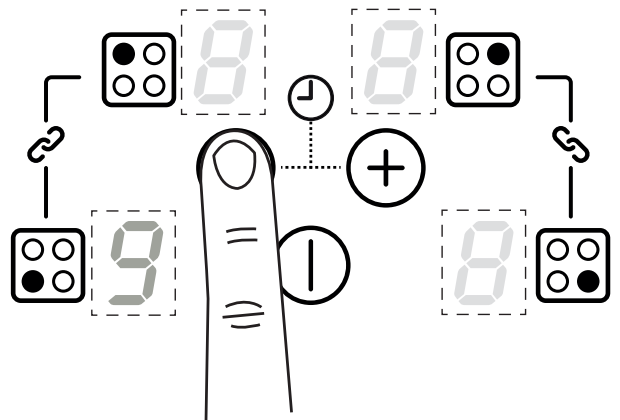

3 Press the plus key until "P" appears

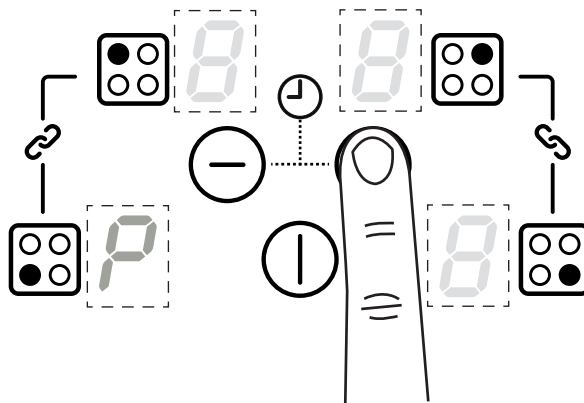

Child Lock

- 1** Press and hold the minus key and right hand front cook zone. A sound will be heard.

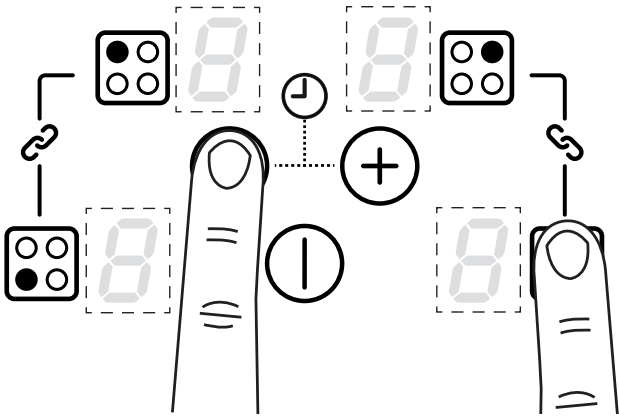

- 2** Press the right hand front cook zone. "L" will appear on the display.

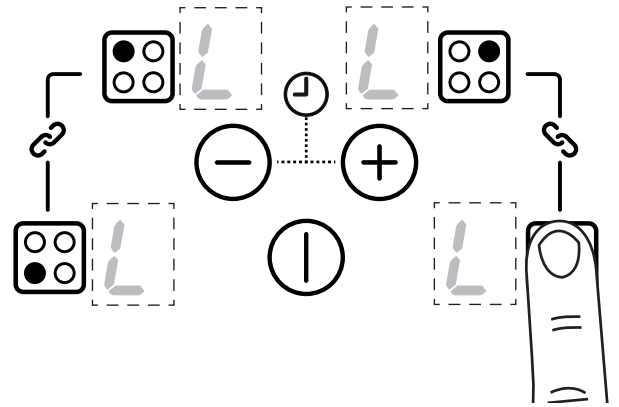

- 3** Press the On/Off key

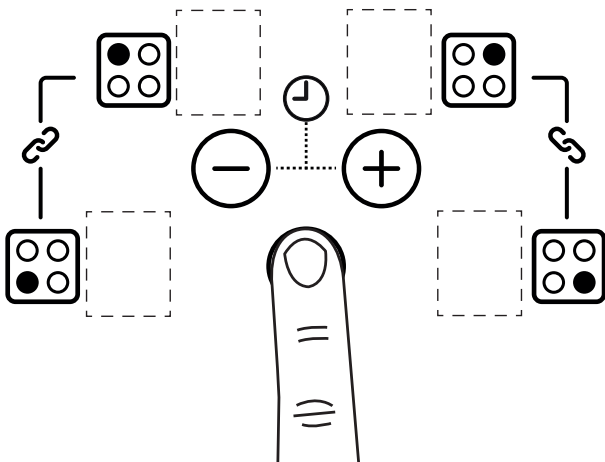

- 4** When the hob is switched on the hob "L" will appear in all the cook zone displays.

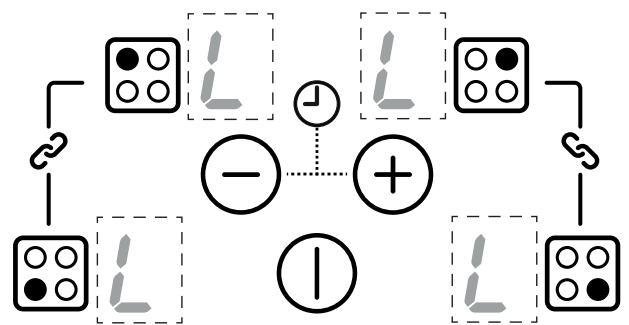

The child lock feature will be activated until you switch this feature off.

De-activating Child Lock

1 Press the On/Off key and “L” will appear in all cook displays.

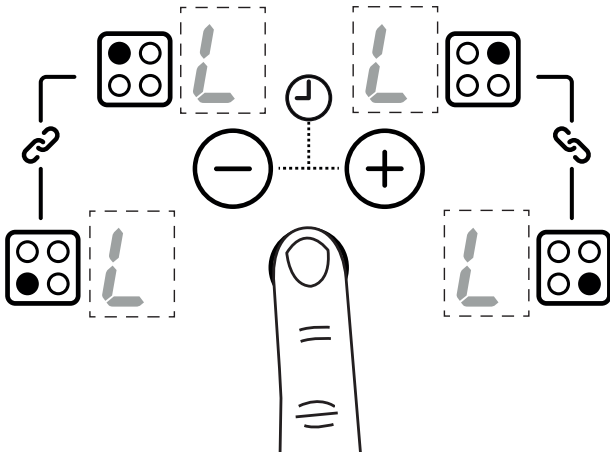

2 Press and hold the minus key and the right hand front cook zone. A sound will be heard.

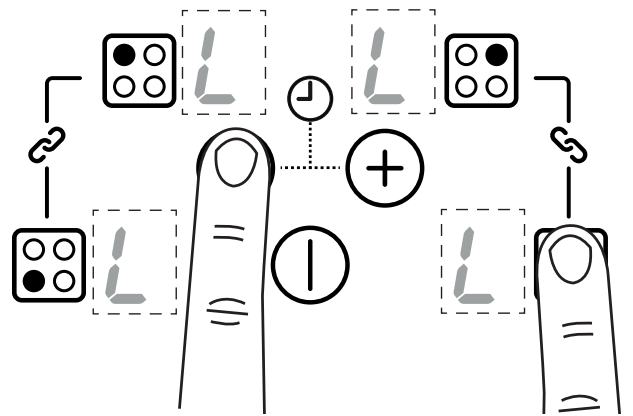

3 Press the minus key and “L” will disappear from all cook zone displays

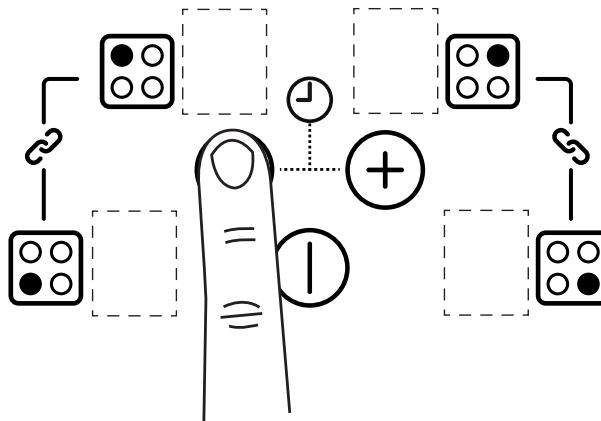

When you now switch on the hob “0” will be displayed in all cook zone displays, the hob can now be used normally.

Setting the minute minder

1 Press and hold the minus key and plus key

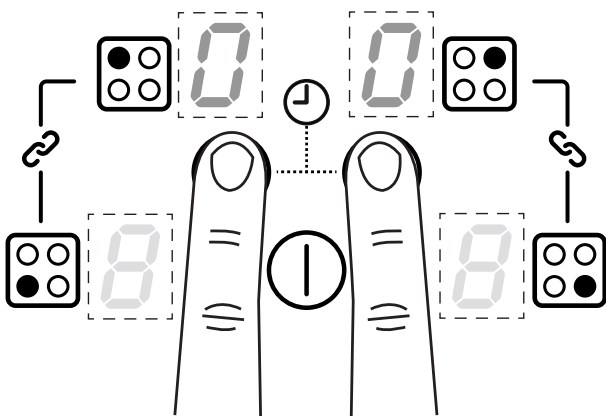

2 Set a time by pressing the minus or plus keys.

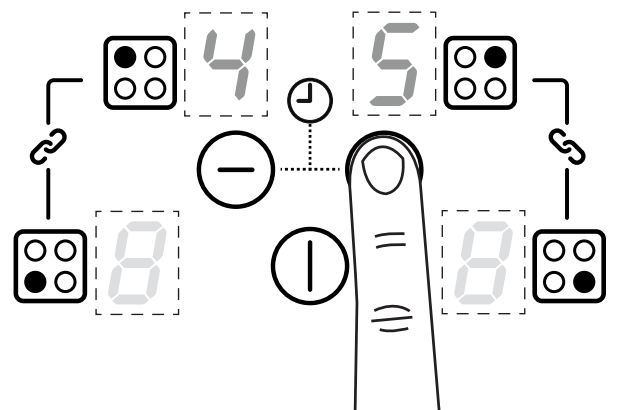

Please ensure that no cook zones have been selected.

When the time is up

When the set time has expired, it does not switch off any cook zones. A sound is heard and “00” will flash on the display. Press the minus or plus key to stop the alarm. The dots will flash on the display if the hob is turned off before the minute minder ends.

To modify or cancel the minute minder

Repeat the same steps for “Setting the minute minder” to modify the time. Setting back to zero will cancel the minute minder.

Timer auto switch off

Note: Cook zones(s) must be switched on

1 Choose require cook zone(s)

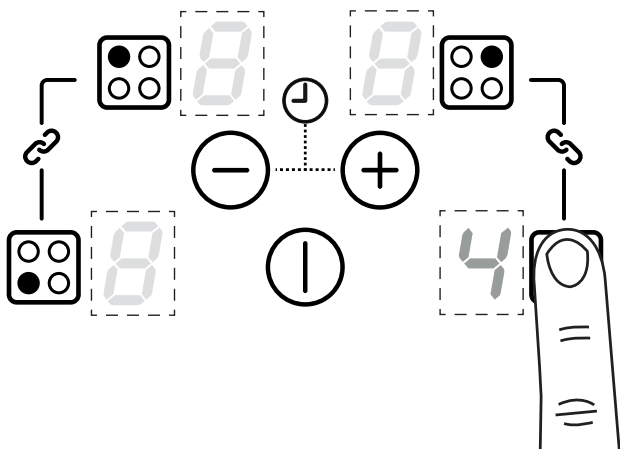

2 Press and hold the plus minus keys. A dot will appear in the chosen cook zone display

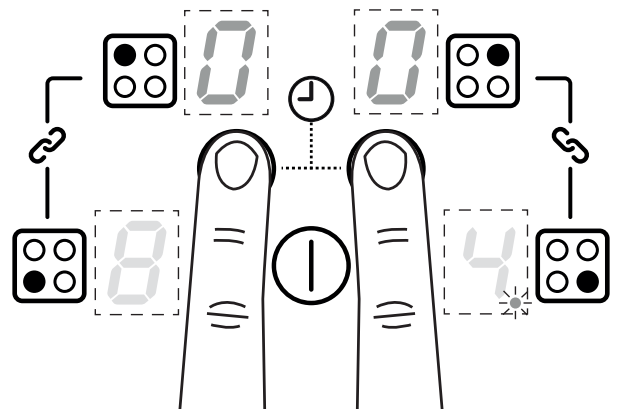

3 Press the plus or minus keys to set a time.

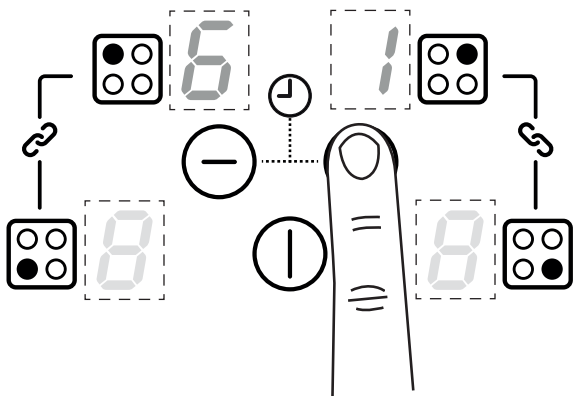

4 A dot appears in the cook zone display when a time is set.

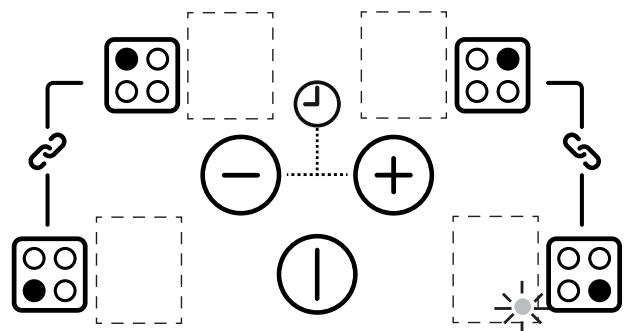

The timer indicator in the display stops flashing and is not displayed. Operation of a timer is shown by a stationary dot in the cook zone display for the timed cook zone.

When the time is up

When the set time has expired, a sound will be heard and the dot will begin to flash on the cook zone display. Press the minus or plus key to stop the alarm.

To modify or cancel the timer

Repeat the above steps to modify the time. Setting back to zero will cancel the timer.

To check the time for a cook zone

1 Choose required cook zone.

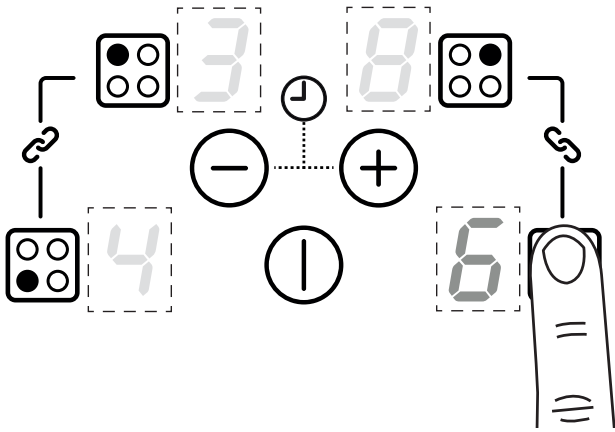

2 Press and hold the minus and plus keys together. The remaining time will appear on the display.

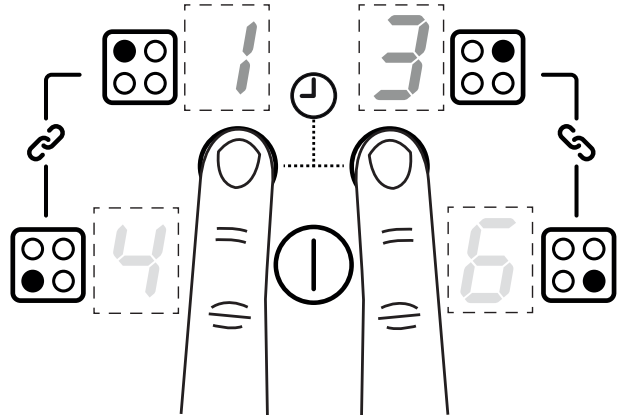

To check the time for multiple cook zones

Active cook zone times are cycled clockwise

1 Ensure no cook zone has been selected

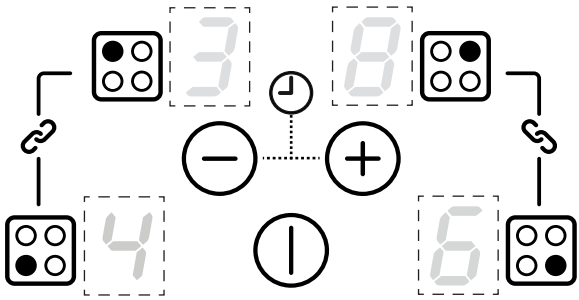

2 Press the minus and plus together

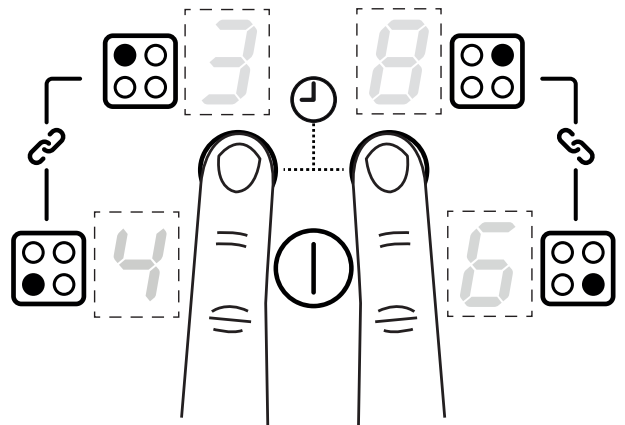

3 Press the minus and plus as many times as necessary to display the timer for the required cook zone

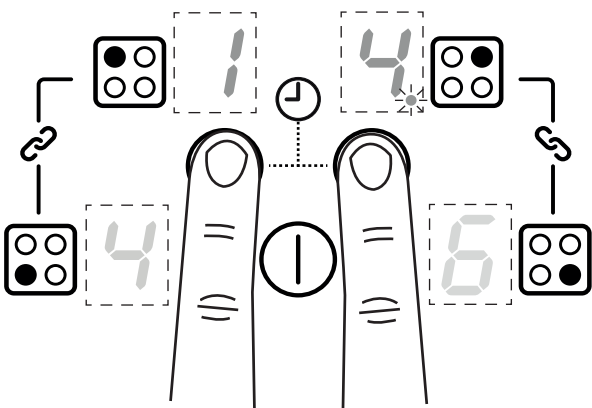

4 A dot will flash in the chosen cook zone display

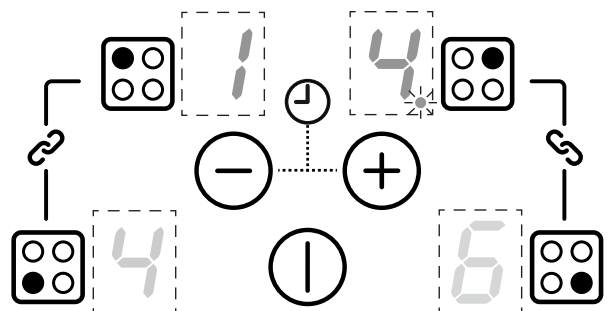

Note: If the minute minder has also been set it will be displayed first. In this case other timed cooking zones are shown by a dot in the cook zone display.

Pan Detection

The hob only uses power when a suitable pan is placed on the zone, this reduces the energy used during the cooking process, i.e. when you take your pan off the zone the hob automatically turns the power off, and only switches back on when you replace the pan.

Bridge function

1 Press the linked cook zones keys together.

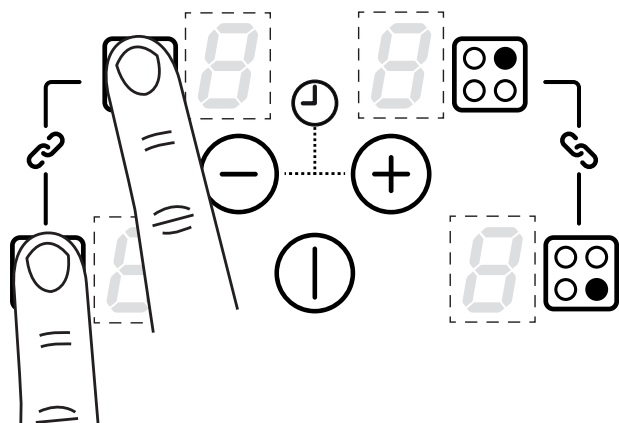

2 Bridge symbol will appear in the right or left front cook zone

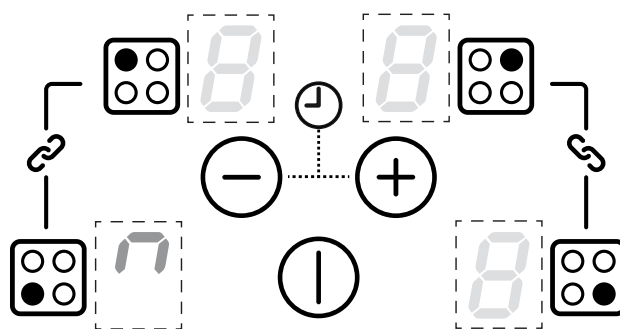

The cooking zones can be used as four separate cooking zones which can be controlled individually. Or, the two left hand zones and the two right hand zones can be bridged to provide two large zones that can be controlled via one setting.

Large pans and griddle plates can be placed across these two bridged zones.

Residual heat indicators

This feature not only warns you against hot surfaces but also indicates that there is residual heat which can be used as temporary warm zone.

Note: The cook zone itself does not heat up, but the ceramic glass does get hot because of the hot pan conducting heat back onto the hob glass.

Auto stand by

The hob will automatically switch off if left (with pan) on for an extended period of time, see maximum running times below

Power Level	Maximum Operation Time hours
1	8
2	6
3	5
4	5
5	4
6	1.5
7	1.5
8	1.5
9	1.5
P (Power Boost)	5 minutes

Appliance errors





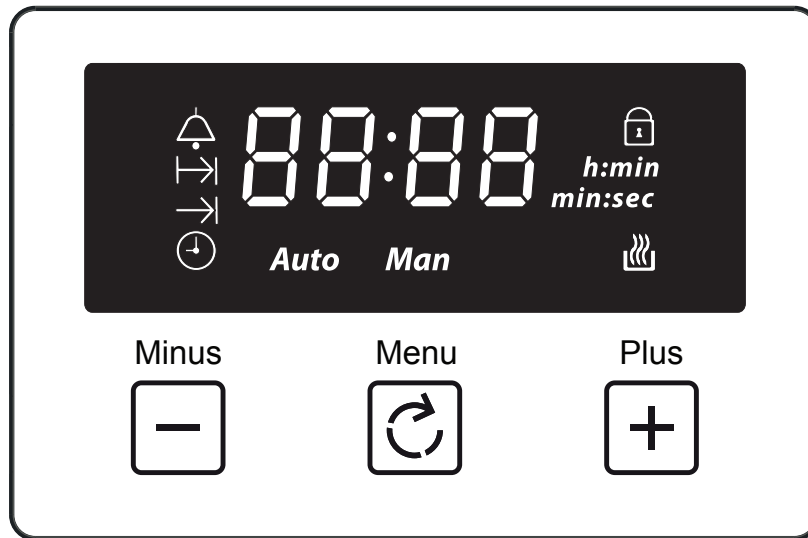

Appliance Errors	Fault Description	Action
ER03 and permanent tone	Continuous button actuation; control switches off after 10 seconds	Clean the user interface.
E2	Over temperature	Allow system to cool
E3	<ol style="list-style-type: none">1. Pot/pan not suitable, example Loss of magnetic properties because of temperature at bottom of pot.2. Power of cooking zones permanently exceeded	<ol style="list-style-type: none">1. This error is reset after 30 seconds; the cooking zone can be used again. The pot/pan must be removed if the fault keeps reoccurring.2. The power unit must be replaced if the error continues to be displayed even when no pot/pan is present on the cooking zone.
E/H	Invariable resistor fault	Induction module must be cool

Please be aware that only the main oven is controlled by the programmer.

Clock / Programmer

Note: Your clock / programmer may not have all these functions



	Minute minder	Man	Manual mode
	Cooking time / Duration	L 1, L 2, L 3	Volume level
	End of cooking time	23:59	7-segment display
	Time of day	99:00	Max. adjustable minute minder
	Keylock	23:59	Max. adjustable cooking time
	Auto cooking	h:min	Display hours:minutes
Auto	Automatic mode	min:sec	Display minutes:seconds

Using the touch controls

Menu - Scroll through to select a function

Plus - Increase time or volume

Minus - Decrease time or volume

When a function is selected and the time or volume is set, the chosen function will automatically start seven seconds after setting.

Manual Mode

If the programmer is not in semi-automatic or full-automatic mode you can use oven functions manually. The manual icon is also on the display.

Setting the time of day

By pressing menu, scroll through the functions until you reach 'time of day'.

1

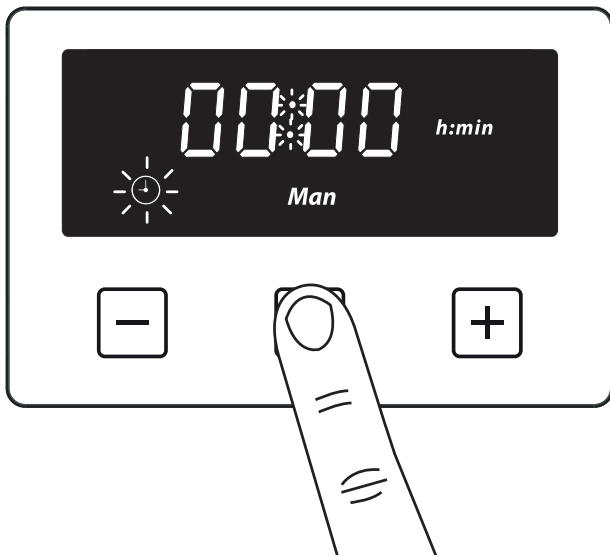

2

Press the plus or minus buttons to set a time

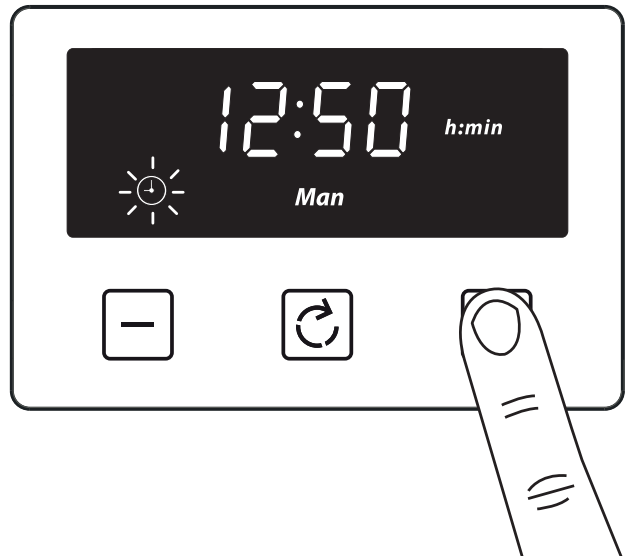

Setting the minute minder

The maximum cooking time that can be set is 99 minutes.

1

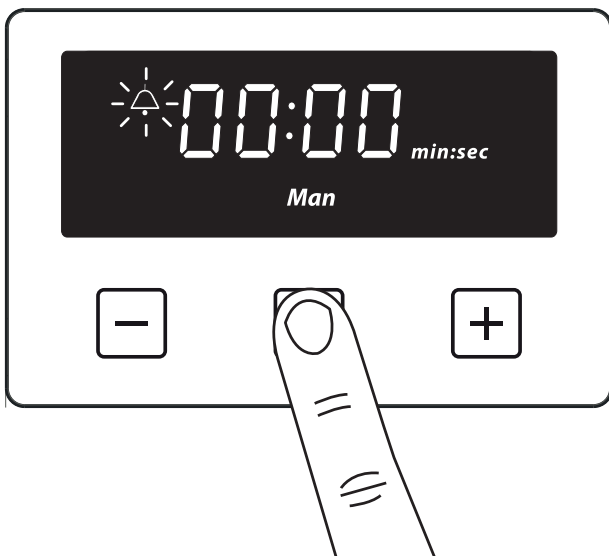

2

Press the plus or minus buttons to set a time

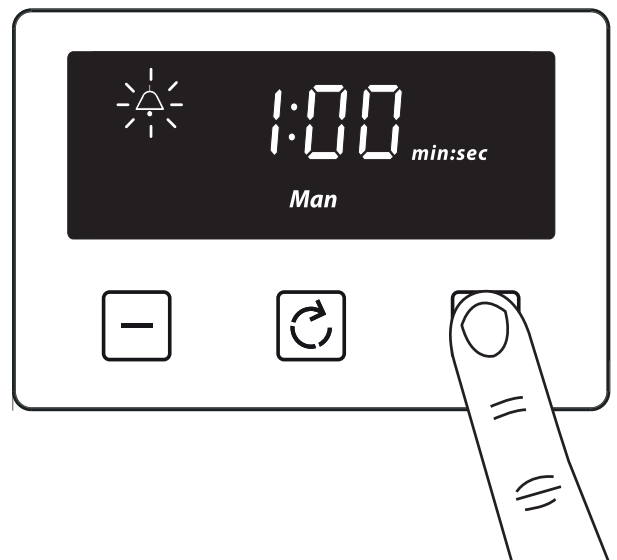

Once set, the minute minder will start to countdown in steps of seconds. The display will show the minute minder symbol and the remaining time. The countdown will continue in the background, if other functions are being set.

When the set time for the minute minder has completed, an alarm is heard and the minute minder symbol will flash on the display. Press any button to stop the alarm and the time of day is displayed.

To modify or cancel the minute minder

Return to the minute minder function and use either the plus or minus buttons to adjust the time. By setting the time to '0.00', this will cancel the countdown.

Setting the cooking time (the duration of time the oven will operate for)

The maximum cooking time that can be set is 23 hours and 59 minutes.

1

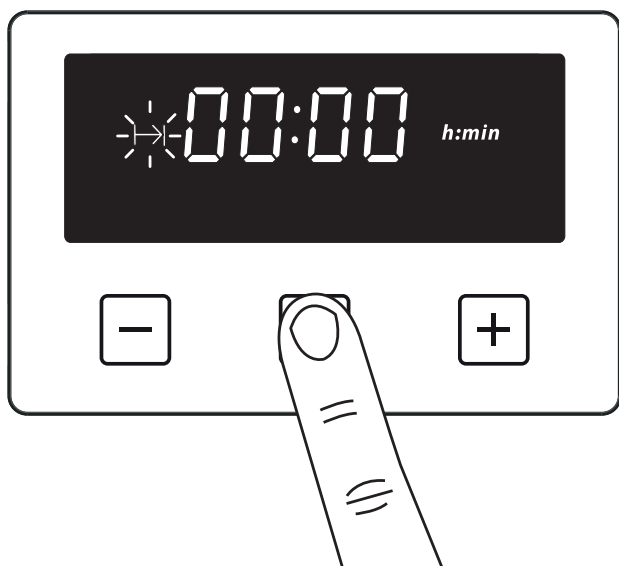

2

Press the plus or minus buttons to set a time

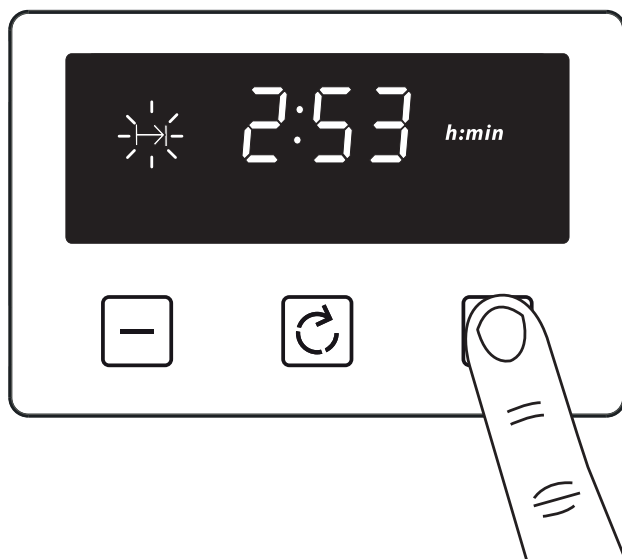

Once set, the automatic mode, auto cooking symbol and the time of day is displayed.

When cooking is completed, an alarm is heard and the manual mode symbol flashes on the display. Press the Menu button to stop the alarm and then the 'time of day' will then be displayed. Pressing the Menu button again will return to manual mode.

To modify or cancel the cooking time

Return to the 'cooking time' function and use either the plus or minus buttons to set the time. By setting the time to '0.00', this will cancel the countdown.

Setting the end of cooking time (to set a time for the oven to turn off)

The display shows the current 'time of day' plus the 'end of cooking time' symbol. The latest 'end of cooking time' is limited to the current 'time of day' plus the maximum time that can be set (23 hours and 59 minutes).

1



2

Press the plus or minus buttons to set a time

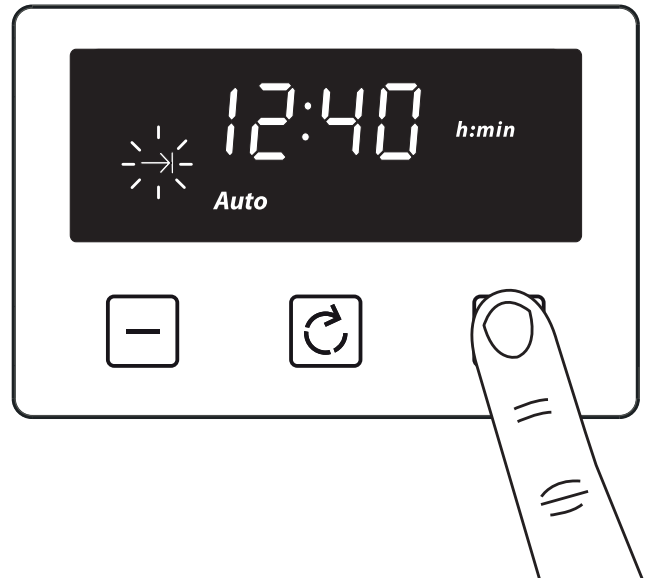

The auto cooking symbol disappears from the display once the time, the required cooking settings and temperature have been set. The appliance will not be switched on until the set cooking start time, that is the difference between the cooking end time and the cooking duration.

When cooking is completed, an alarm is heard and manual mode symbol flashes on the display. Press the menu button to stop the alarm. Pressing the Menu button again will return to manual mode.

To modify or cancel the end of cooking time

Return to the 'end of cooking time' function and use either the plus or minus buttons to set the time. The 'end of cooking time' can be deleted by counting back using the minus button until it equals the current time of day.

Setting the volume

Press the menu button until "LX" (X = 1, 2 or 3) flashes on the display. Use the plus or minus buttons to select a tone.

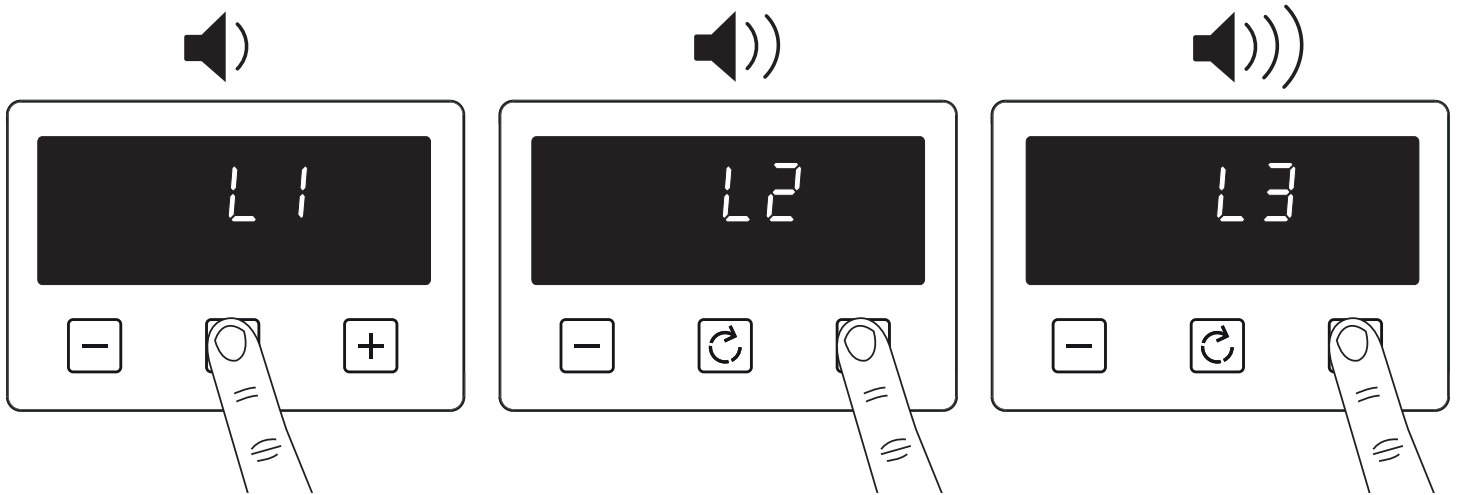

Note: Default tone is L3

Activating / deactivating Key lock

1 Press and hold the plus button for 3-5 seconds

2

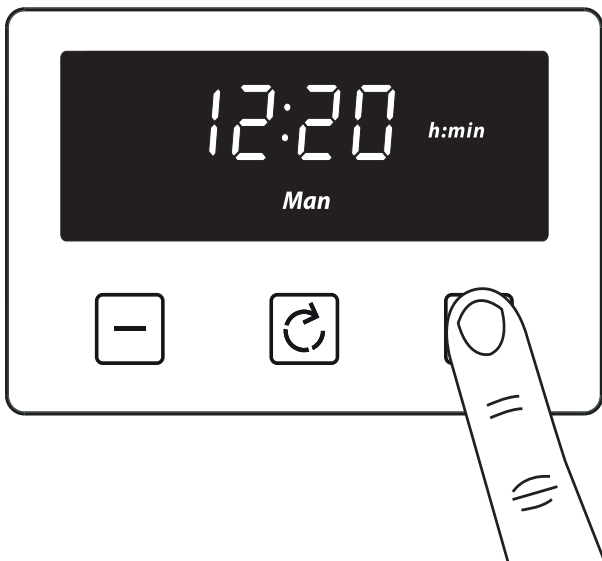

Once the Key lock is active, the buttons will be inactive. A two beep signal will be heard if the buttons are pressed.

To deactivate the Key lock

Press and hold the plus button for 3-5 seconds. The Key lock symbol will disappear and the appliance can continue to be used.

Note: In case of main power loss for a short time (about 1.5 minutes), timer maintains its status. Key lock status and buzzer tone are memorized independent of the power loss duration.

Removing Shelf Runners

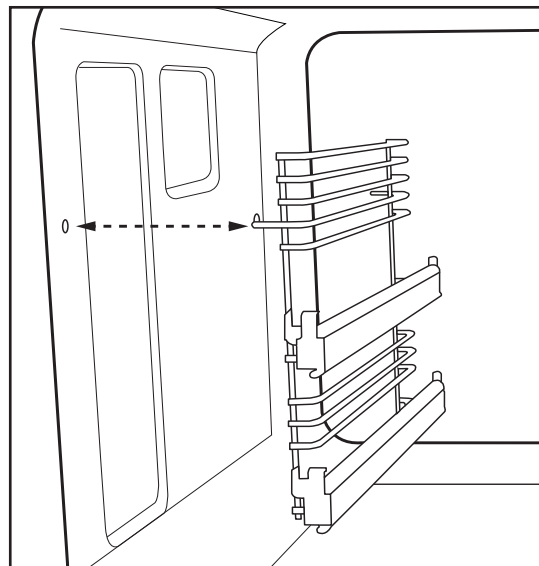
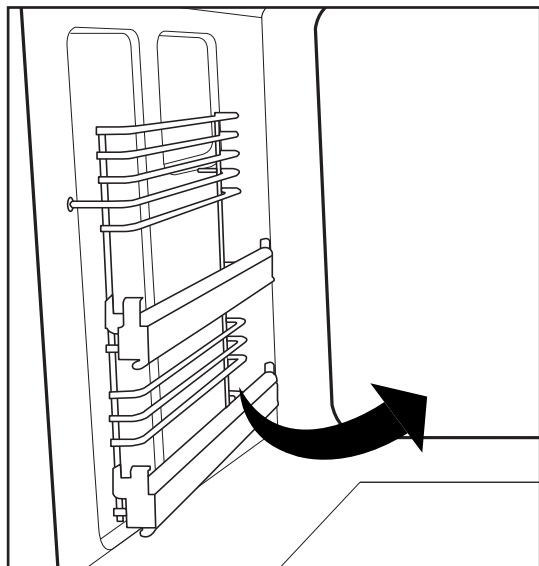

Standard shelves

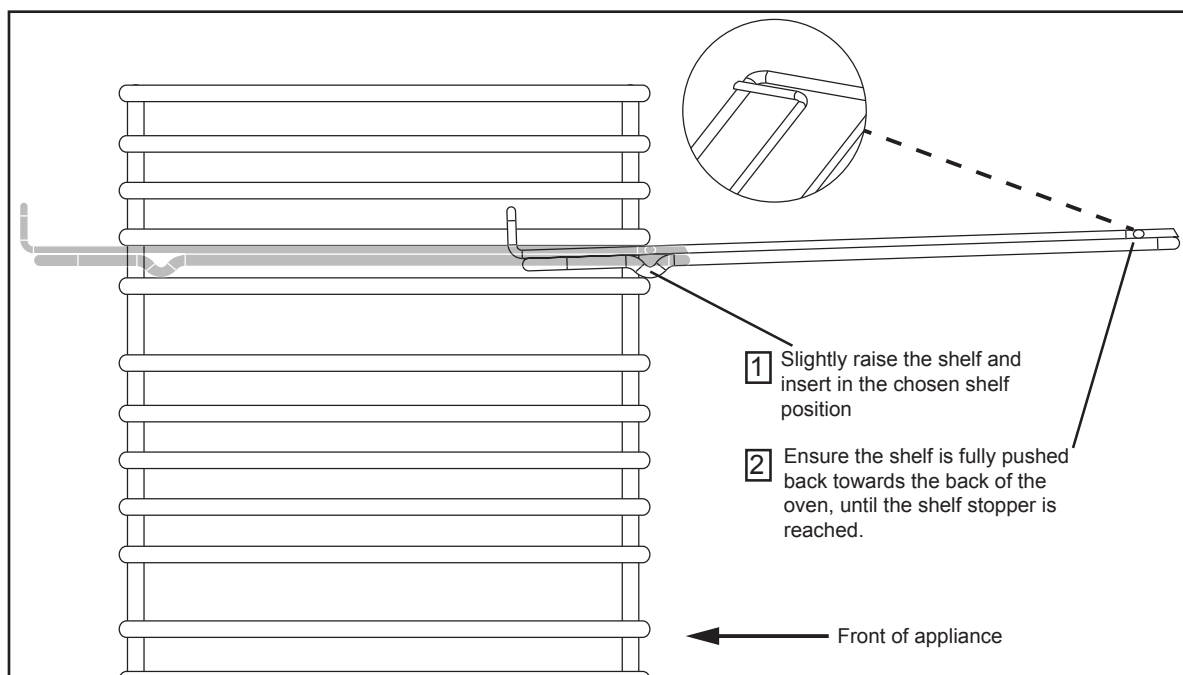

Removing Telescopic shelves (if fitted)

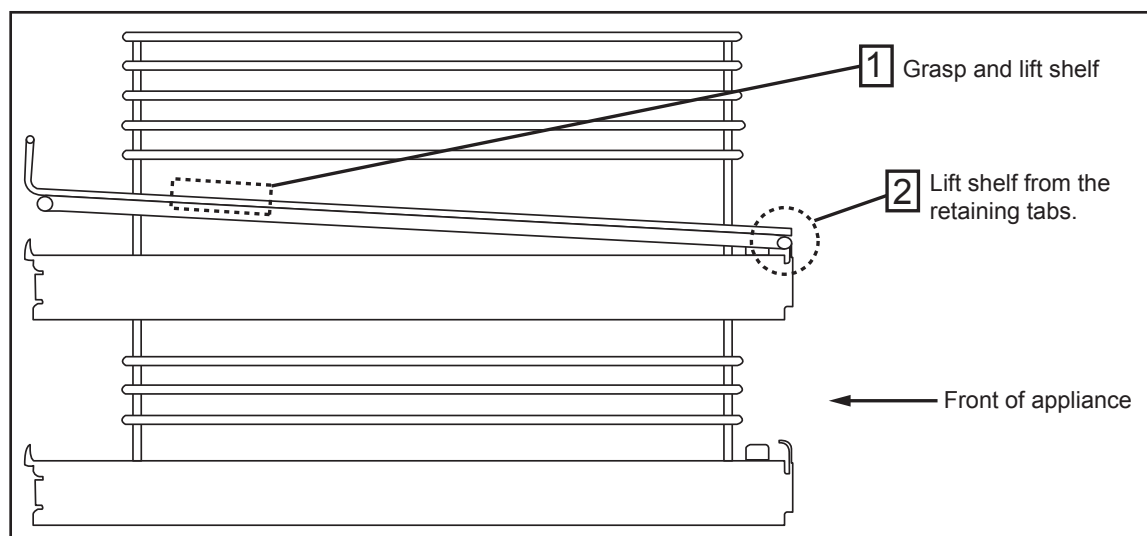

Before removing the shelves completely, please make sure that the shelf is unclipped from the retaining tabs.

Changing the light bulb

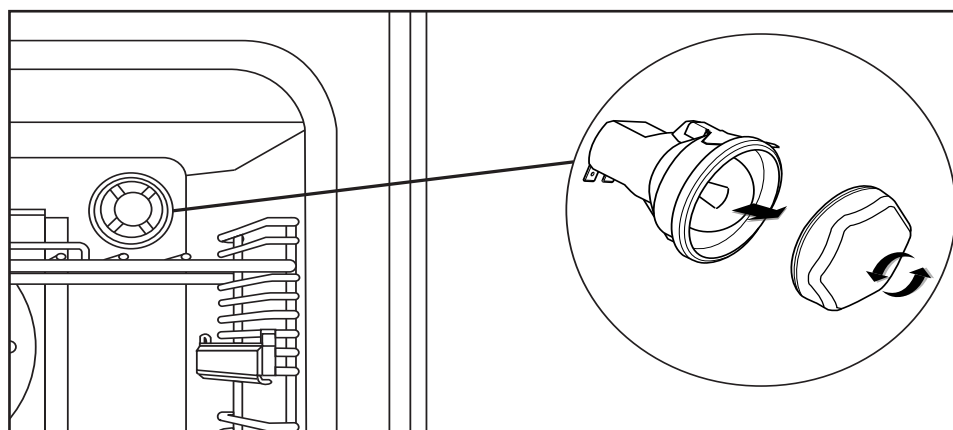

Not all appliances have the same number and type of bulbs. Before you replace your bulb, check to see what type you have. **Please remember that bulbs are not covered by your warranty.**

Additional features

Plate rack (if supplied)

1. Pull the shelf out of the cavity.
2. Tilt the plate warmer towards you and make sure that it hooks underneath the shelf bars at the front.
3. Drop the plate warmer carefully into position.

The plate warmer is now secure and you can place your plates into it.

Always make sure that you use oven gloves if you are putting the plate warmer into a hot, or recently used oven to prevent burns.

Always make sure that your plates are suitable for warming - some plates may shatter or crack when exposed to heat.

We recommend that you heat the oven to 70°C, or below, if you are warming plates.

CLEANING YOUR APPLIANCE

Do's

Note: Always switch off your appliance and allow it to cool down before you clean any part of it.

Note: Please take extra care when cleaning over the symbols on the control panel, as this can lead to them fading.

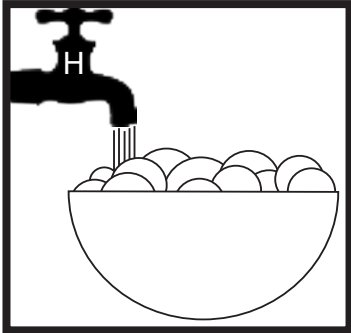

- Warm, soapy water



- Clean, wrung out cloth

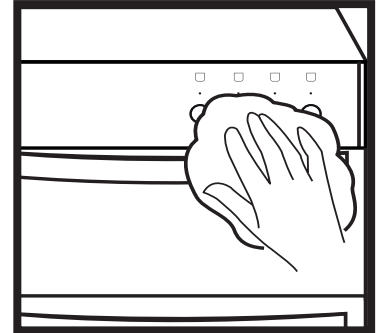

- Wipe with damp cloth
- Dry with a soft cloth

Tips: Some foods can mark or damage the metal or paint work e.g.; Vinegar, fruit juices and salt. Always clean food spillages as soon as possible.

Dont's

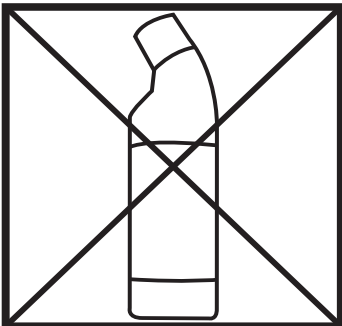

- Undiluted bleaches
- Chloride products

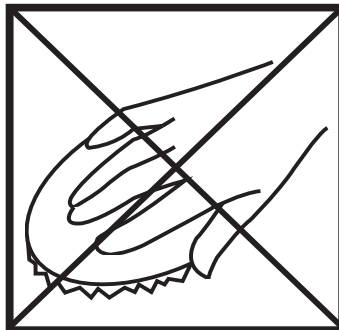

- Wire Wool
- Abrasive cleaners
- Nylon pads
- Steam cleaners

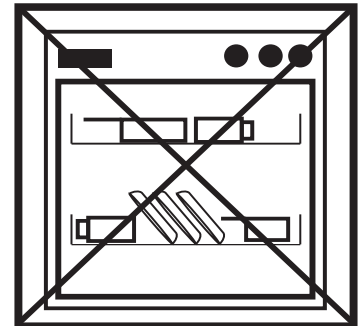

- Do not place in the dishwasher:
- Cast iron griddle
 - Pan supports

IT IS IMPORTANT TO CLEAN YOUR APPLIANCE REGULARLY AS A BUILD UP OF FAT CAN AFFECT IT'S PERFORMANCE OR DAMAGE IT AND MAY INVALIDATE YOUR GUARANTEE.

IN ADDITION TO THE ABOVE, DO NOT USE METAL SCRAPERS TO CLEAN THE OVEN DOOR GLASS.

We offer a great range of cleaning products and accessories for your appliance.
To shop, please visit our website located at the front of this User Guide.

Please keep this handbook for future reference, or for anyone else who may use the appliance.

TECHNICAL DATA

Electric Range

Hob top

Electrical supply / load			
Electrical supply	Hotplate	Zone	Load kW
240v	Induction	All zones	1.4 boost to 1.85

Ovens

Electrical supply / load		
Electrical supply	Oven	Load kW
240v	Fanned (RH)	2.00
	Fanned (LH)	2.50
	Single variable grill (if fitted)	1.85
	Dual variable grill	1.70
	Conventional top (if fitted)	1.39

Oven Lamps / Fans	
Lamp	25W each
Cooling fans	10W each
Oven stir fans	30W each

Appliance

Electrical supply / load		
Appliance Size (cm)	Electrical supply	Max. load (kW)
Single grill models	240v	13.99
Dual grill models		14.84