



CLASSIC

11016

4200
PCS/STCK/PZ
/PZS/DB/
DET/件





Page
36



Page
12



Page
18



Page
32

Page
Seite
Pagina
Pàgina
Oldalszám
Lpp.
页码

Page
27



Page
40



Page
8



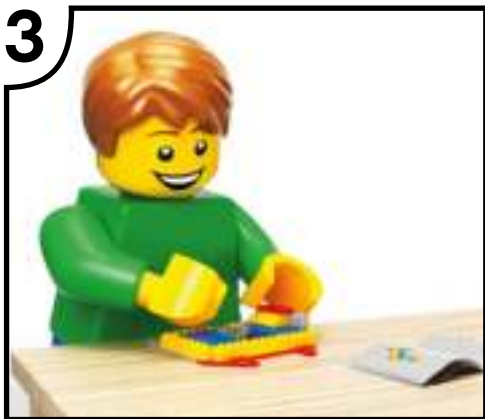



- 1** Scan the code on the front cover
Scanne den Code auf der Titelseite
Scanne le code sur la page de couverture
Scanner le code sur la page couverture
Scansiona il codice sulla copertina
Escanea el código de la portada
Faz scan do código na frente da capa
Olvasd be a borítón látható kódot!
Noskenë kodu uz priekšējā vāka
扫描封面上的二维码



- 2** Get the Building Instructions
Hol dir die Bauanleitung
Obtiens les instructions de montage
Obtenir les instructions de montage
Scarica le istruzioni per la costruzione
Consulta las instrucciones de construcción
Obtém as Instruções de Construção
Szerezd be az építési útmutatókat!
Saņem būvēšanas instrukcijas
获取拼搭说明

LEGO.com/apps

Check for compatibility
Kompatibilität prüfen
Vérifier la compatibilité
Controlla la compatibilità
Comprueba tu compatibilidad

Verificar a compatibilidade
Ellenőrizd a kompatibilitást
Pārbaudīt saderību
检查兼容性

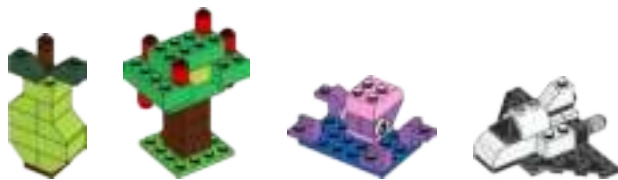
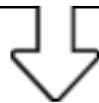
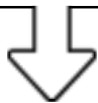

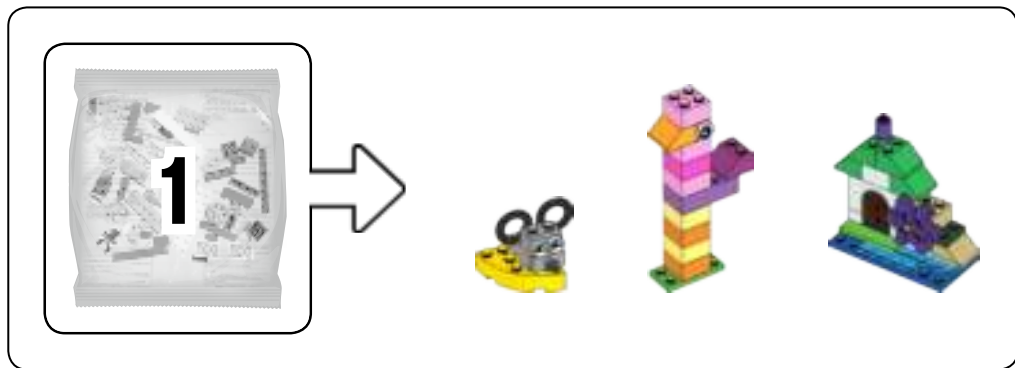

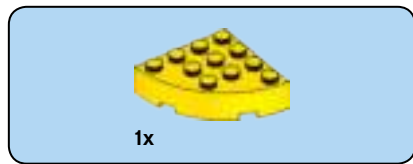

1





2



3



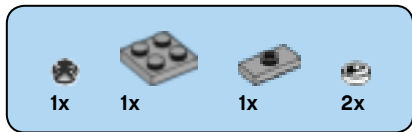

4

1



2



3

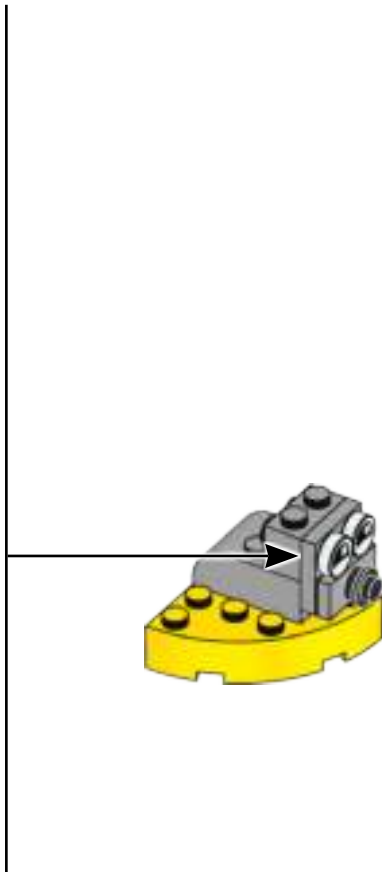



2x

5



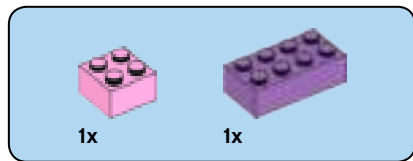

1

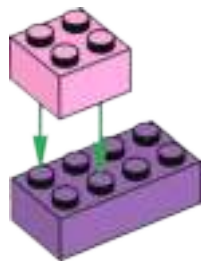

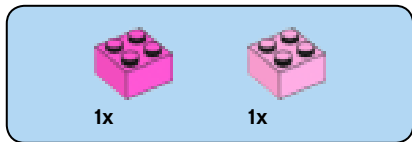

2

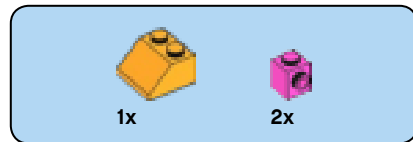
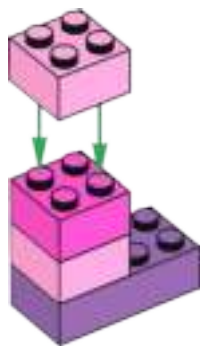

3





2x

4



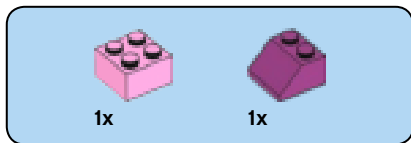

5



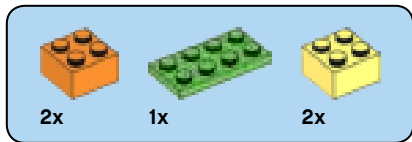

6

1



2

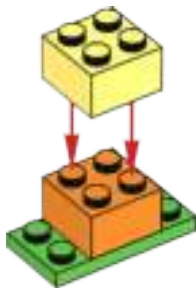

3

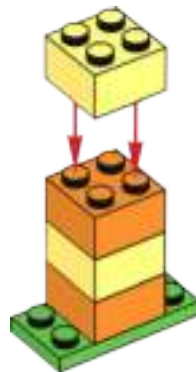

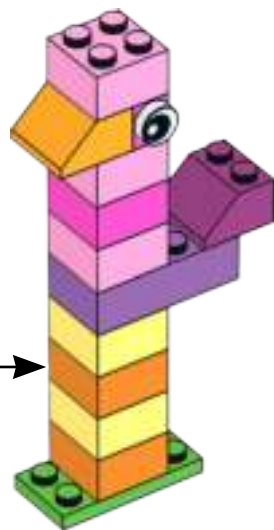

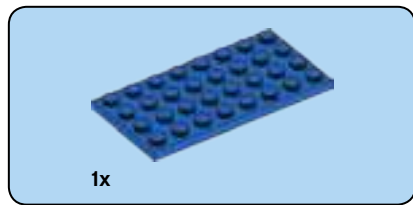

1



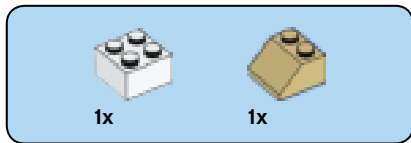

2

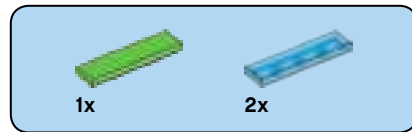

3

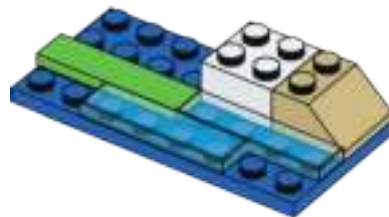

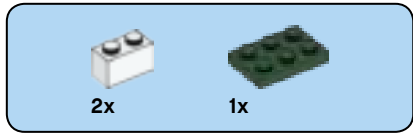

4

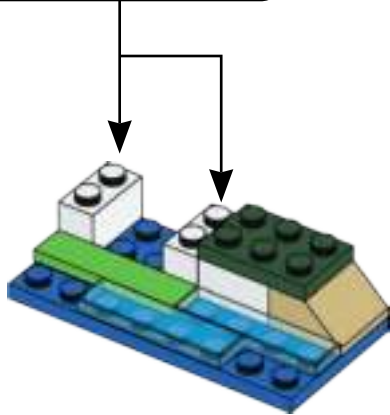
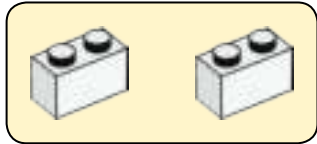

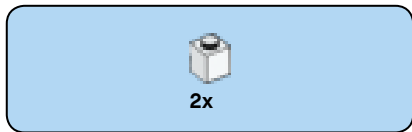

5

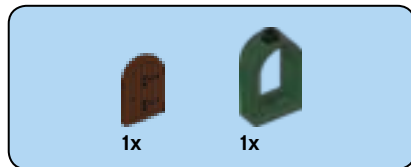
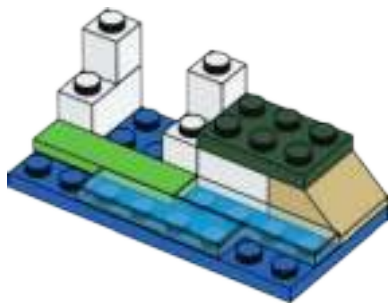

6

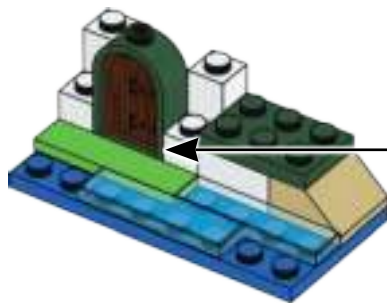

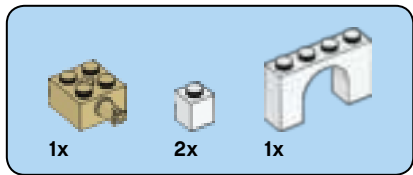

7

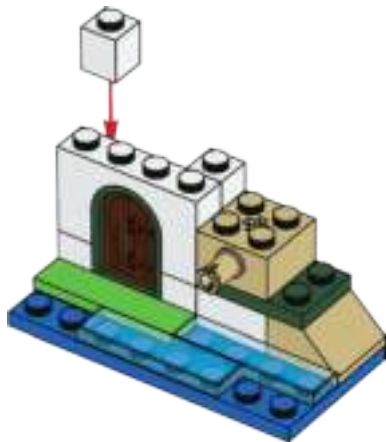



1x



2x

8

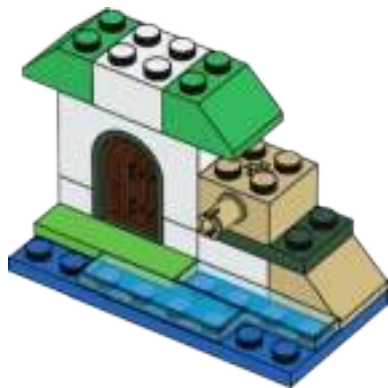

2x

9

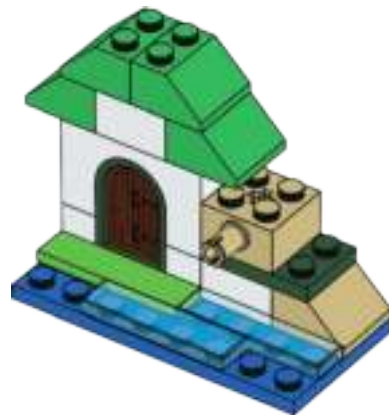



1x

10



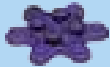

2x

11

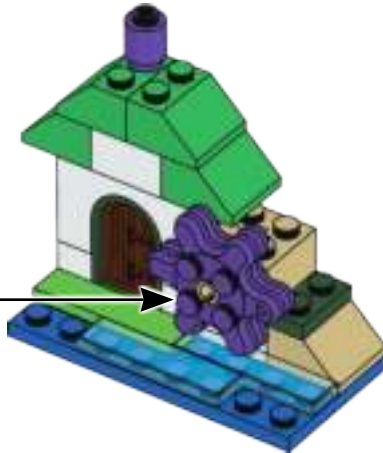
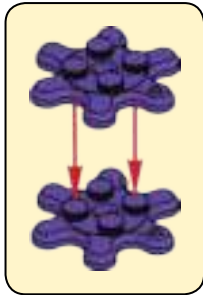





1





2x

2



1x

3



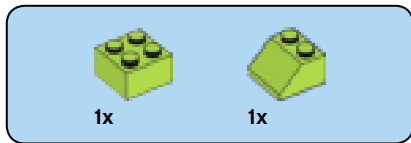

4

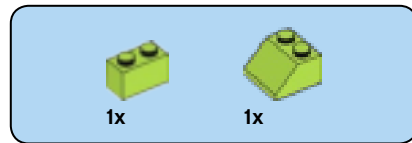

5





1x

6

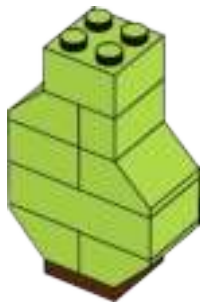

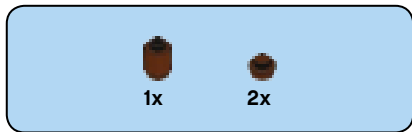

7

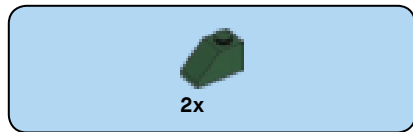

8

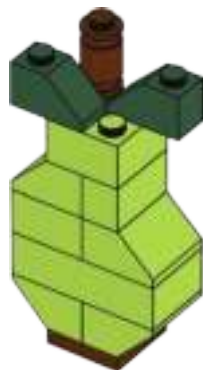

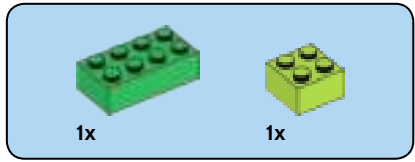

1

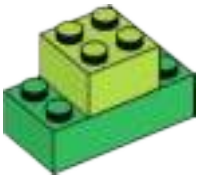

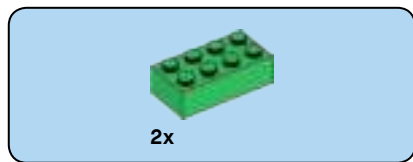

2

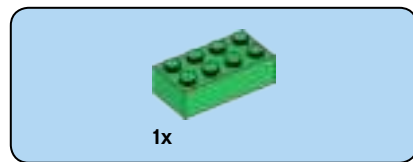
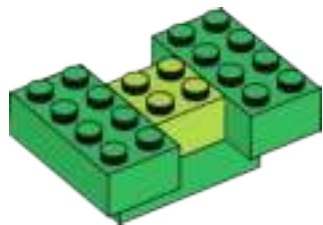

3

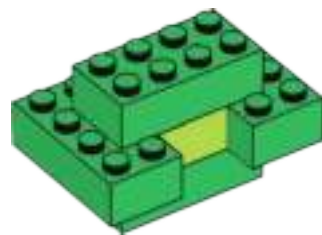



4

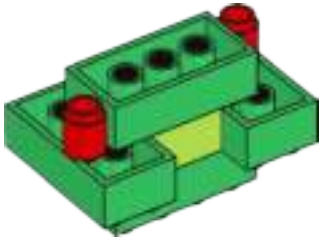

5

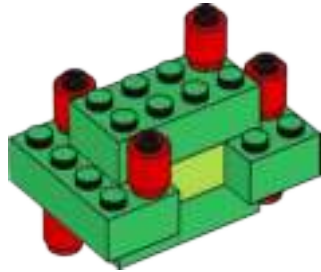

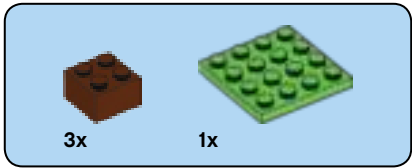

6

1



2

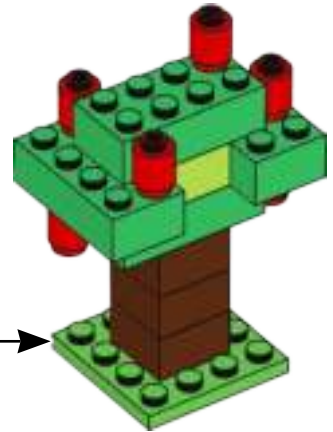



1





2

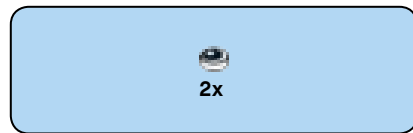
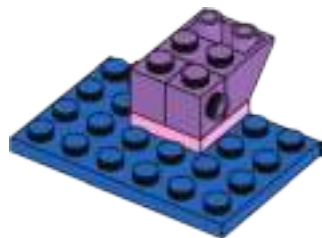

3

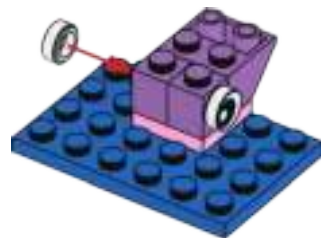



1x

4





4x

5

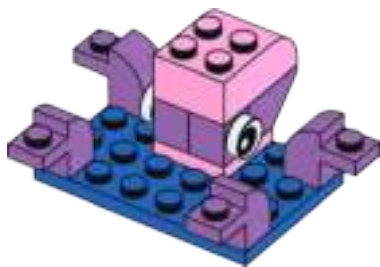

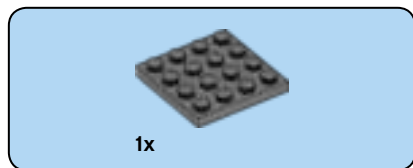

1



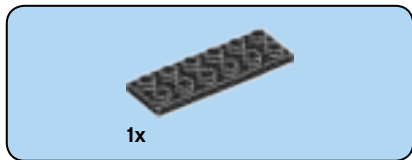

2

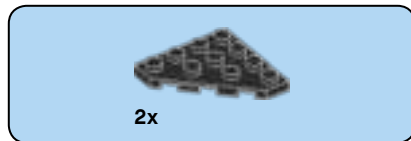

3

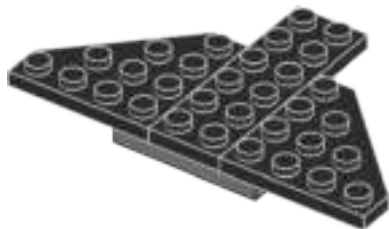

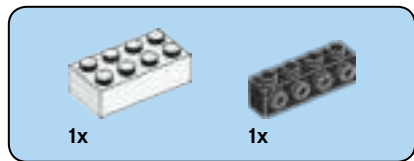

4

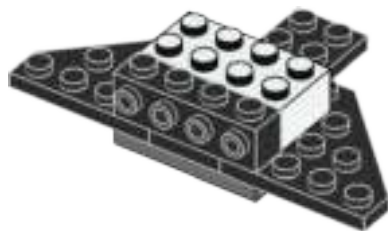



2x



2x

5

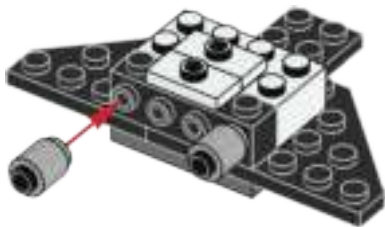

1x

6



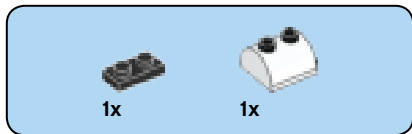

7

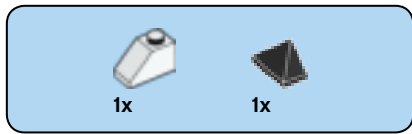
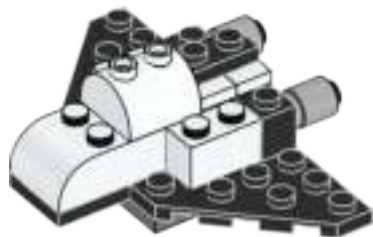

8





CLASSIC

























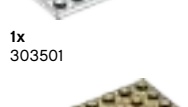

















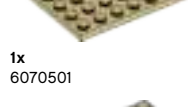

























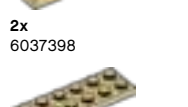

























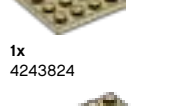





What fun things can you build?
Welche lustigen Sachen kannst du bauen?
Quels objets amusants peux-tu construire ?
Quali cose divertenti sai costruire?
¿Qué cosas divertidas puedes construir?
Que coisas divertidas consegues construir?
Milyen mókás dolgokat tudsz megépíteni?
Kādas interesantas lietas tu uzbūvēsi?
你能拼搭出什么有趣的模型呢？





CLASSIC



 3x 306201	 2x 6210272	 4x 446001	 4x 428601	 1x 303501	 4x 4218749	 4x 4114084	 2x 4124067	 6x 302421
 2x 6284604	 4x 6059185	 5x 4121932	 2x 383901	 1x 6070501	 1x 4623514	 10x 4114306	 6x 4113915	 6x 300521
 8x 6284599	 4x 366501	 5x 4121932	 1x 621501	 6x 4109995	 5x 4114322	 2x 6212758	 2x 4161734	 4x 4651524
 6x 6284605	 2x 6046384	 2x 6238334	 3x 362201	 2x 6037398	 4x 4146221	 4x 4118866	 4x 4579260	 2x 403221
 5x 614101	 4x 6051511	 4x 303901	 5x 300101	 2x 6037398	 2x 6024495	 3x 4162465	 6x 4159553	 2x 6252037
 5x 4504369	 2x 300401	 12x 300301	 5x 300101	 2x 4113993	 4x 4159196	 3x 4162465	 6x 4159553	 2x 6092565
 6x 302401	 6x 302301	 1x 4624989	 1x 4243812	 2x 4113993	 4x 4159196	 1x 6347700	 6x 306221	 6x 300421
 10x 300501	 2x 4521210	 1x 4624989	 1x 4243812	 2x 4113993	 4x 4159196	 4x 4113233	 3x 6206148	 6x 302321
 4x 6046905	 2x 4521210	 1x 4624989	 1x 4243812	 2x 4113993	 4x 4159196	 4x 4113233	 2x 4529234	 6x 302321
 2x 4626882	 2x 6248827	 4x 366001	 2x 4181142	 1x 4243824	 2x 4273526	 3x 4113916	 2x 4529234	 4x 4121934
 2x 4224792	 4x 302201	 3x 6031098	 2x 6033776	 2x 4181134	 4x 4121972	 3x 4113916	 5x 614121	 4x 4121934
						 5x 4516055	 5x 4504379	 4x 302221



4x
6146217



2x
4515371



4x
4143832



2x
4521438



10x
300321



4x
303921



3x
362221



4x
428621

48



2x
6268946



4x
371021



3x
301021



2x
302021



8x
300121



2x
366621



2x
4181138



2x
303421



2x
6036408



1x
303623



2x
303523

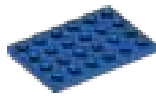

1x
303223



2x
6037384



2x
4181139



2x
614323



6x
302323



6x
300423



4x
6133724



3x
362223



3x
301023



4x
371023



2x
302023



1x
4243815



8x
300123



2x
366623



6x
302423



6x
300523



4x
4651236



2x
403223



3x
306224



3x
6299813



2x
4525464



5x
302424



6x
300524



2x
403224



6x
300424



2x
4188357



4x
302224



10x
300324



3x
362224



3x
621524



3x
301024



1x
6339202



2x
379524



2x
4181143



2x
303424



2x
4639693

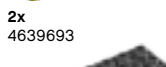

2x
6037390



2x
303426



3x
379526



8x
300126



2x
4160025



2x
4529236



6x
614126



5x
4504382













































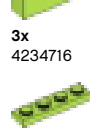







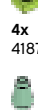



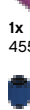

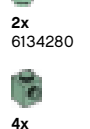

4x
4558954



2x
4214559

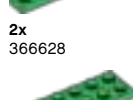

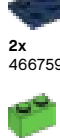
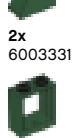
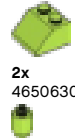
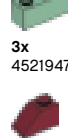
2x
6210270

								
1x 6051508	1x 4162443	4x 302228	2x 4181135	2x 4518029	1x 6195267	1x 6003056	5x 4504372	2x 4529679
							4x 6073026	
2x 403226	2x 302026	8x 303928	2x 303428	6x 4121739	3x 6141590	6x 4255624		3x 4220632
							4x 6025026	
4x 4121966	5x 4569058	3x 4109679	1x 4277361	2x 4153825	2x 4617799	4x 6223304	6x 4164037	3x 4234716
							2x 6092592	
2x 4515373	6x 302428	4x 6268814	1x 4507311	3x 4118827	2x 6244886	1x 4650244	7x 4164022	4x 4187743
								
2x 6138173	6x 300528	4x 371028	1x 4507311	1x 4550362	2x 6253876	2x 4586057	2x 4212446	2x 6134280
	4x 6229130						2x 412446	4x 6009656
4x 4618852	4x 6000071	12x 4106356	2x 6244887	3x 4177741	2x 6035029	2x 6215657	4x 4537925	
	2x 6092586					2x 6215657	4x 4537925	
1x 302326	2x 6092586	2x 366628	2x 6252050	2x 4667595	2x 6003331	1x 4165967	2x 4650630	3x 4521947
	6x 302328					1x 4165967		
2x 6097072	6x 302328	2x 366628	2x 6252050	6x 4647553	2x 6252204	2x 4529160	3x 4212454	4x 4541526
	2x 6270719	2x 379528	3x 6214234					
4x 303926								



4x
4609925



3x
6052777



2x
4282860



4x
6024286



6x
6028736



2x
6122504



2x
6334836



4x
6023157



4x
6170916

50



5x
6020181



5x
6023173



4x
6020073



2x
6071607



2x
6097511



8x
6100027



2x
6020074



4x
4211183



7x
4216581



6x
4221744



3x
4624507



2x
6253167



2x
4211159



4x
4211180



6x
4211149



1x
4542131



5x
4216695



13x
4211210



4x
4211190



3x
4211225



2x
4538252



2x
4211186



2x
4211247



1x
4211207

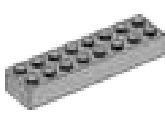

2x
6037399



5x
4211412



2x
4529241



5x
4211525



5x
4521921



6x
4211399



6x
4211389



4x
4211445



2x
4211395



8x
4211385



2x
4211475



1x
4657459



2x
4515374



4x
6146223



3x
6066097



6x
4211388



6x
4211398



4x
4211564



4x
4211614



4x
4211494



5x
4211397



10x
4211387



4x
4211410



3x
4211428



1x
4217918



3x
6211394



2x
4211435



2x
4211406



2x
4211438



2x
4211795



2x
4211452



3x
4618655



2x
6217793



2x
6271374



1x
4517992



4x
4211096



4x
4211000



1x
4243831



2x
4210875



3x
6212501



2x
6329300



5x
4517996



6x
6031883



5x
4599538



6x
4517993



6x
4654128



4x
4517995



5x
6096589



3x
4550359



1x
6143795



4x
6002148



3x
4518890



2x
6204535



8x
4520632



2x
6058222



2x
4625633



2x
6228963

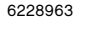

2x
6338201

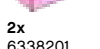

4x
4621554



2x
6212064



1x
6070305



6x
6231376



4x
6109814



4x
6047422



4x
6107200



10x
4653960



2x
6238330



2x
6109931



2x
6173106



3x
6154879



6x
4619652



2x
6287425



6x
6092674



2x
6331949



10x
4653970



2x
6146866



2x
6125776



6x
4651903



6x
4625616



1x
6223452



5x
4655173



3x
6209673



1x
6213252

Customer Service

Kundenservice

Service Consommateurs

Servicio Al Consumidor

LEGO.com/service or dial



: 00800 5346 5555

: 1-800-422-5346



WIN

GO TO WWW.LEGO.COM/PRODUCTFEEDBACK AND
GIVE US YOUR SHORT **FEEDBACK** ABOUT THIS
LEGO® SET FOR A CHANCE TO WIN
A COOL LEGO PRIZE.

Terms & Conditions apply

LEGO.com/productfeedback

GEWINNE

Erzähle uns auf
www.LEGO.com/productfeedback

etwas über die Erfahrungen, die du mit
diesem LEGO® Set gemacht hast, und
sichere dir die Chance auf einen coolen
LEGO Preis!

Es gelten die Teilnahmebedingungen

GAGNE

Rends-toi sur
www.LEGO.com/productfeedback

et donne-nous quelques commentaires sur
ce produit LEGO® pour avoir une chance
de gagner un prix LEGO !

Voir Conditions Générales

GANAN

Visita
www.LEGO.com/productfeedback

y envíanos tu opinión acerca de este set
LEGO®. ¡Participarás en el sorteo de un
premio LEGO!

Términos y Condiciones aplicables

获取奖品

登录
www.LEGO.com/productfeedback

给出关于此乐高®套装的简短反馈，
就有机会获得炫酷乐高奖品

《条款及条件》适用

LEGO and the LEGO logo are trademarks of the LEGO Group. ©2021 The LEGO Group.

6353517