

LASER PEGS

It's Your Imagination, Light it Up!

www.LaserPegs.com/MISSION CONTROL/18004

MISSION MARS



WARNING: CHOKING HAZARD-
Small Parts. Not for children under 3 yrs.



ATTENTION: DANGER DE SUFFOCATION.
- Petits éléments. Ne convient pas aux enfants de moins de trois ans.

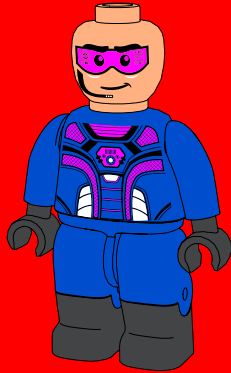
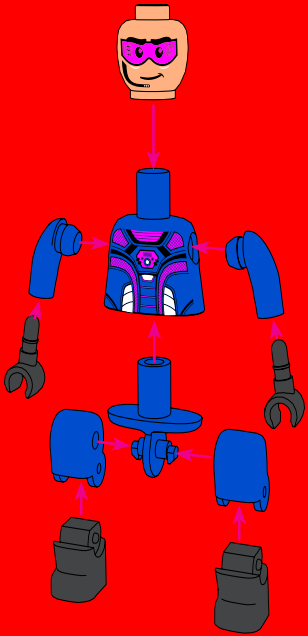
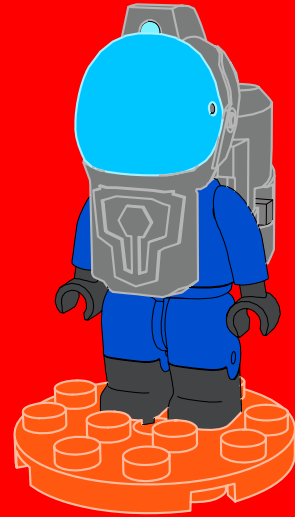
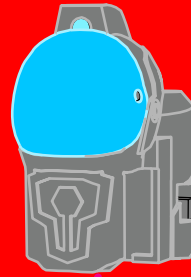
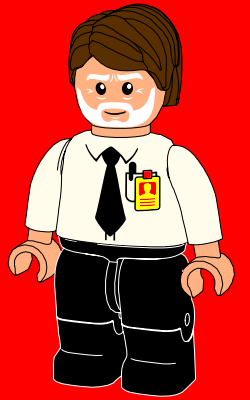
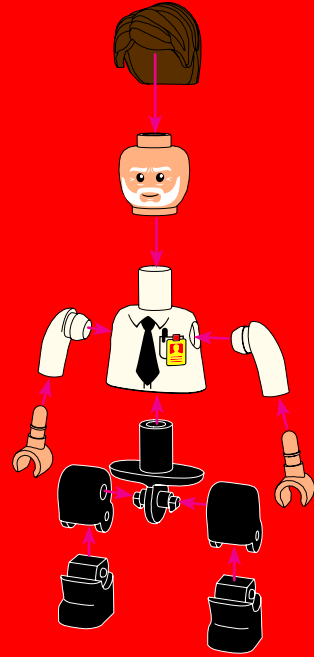
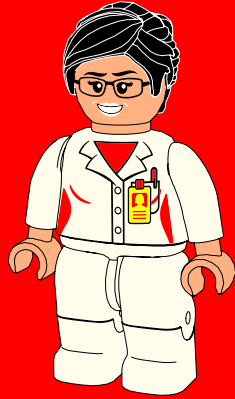
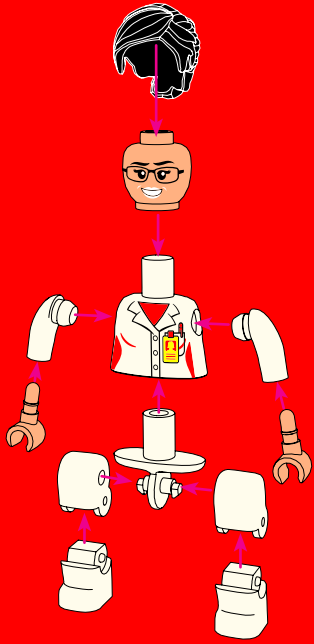

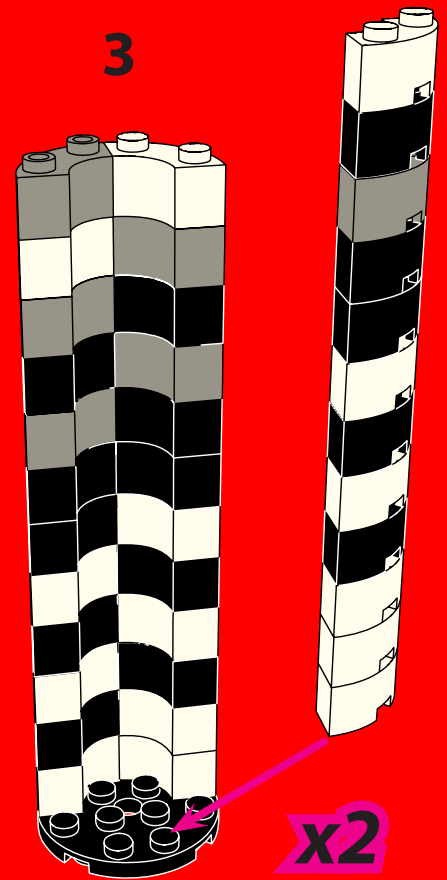
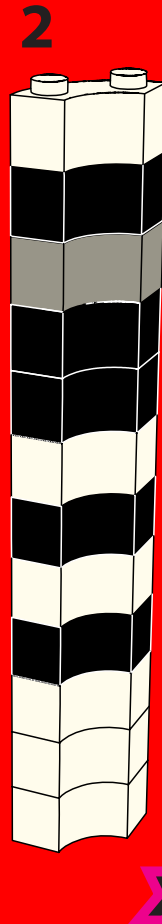
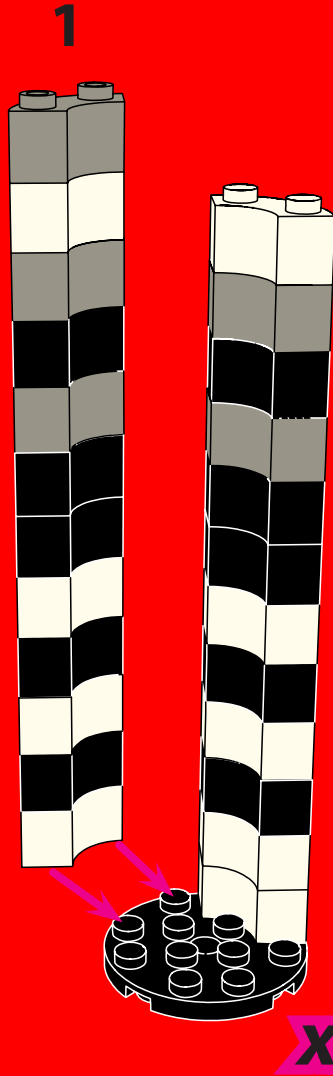
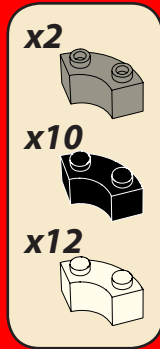
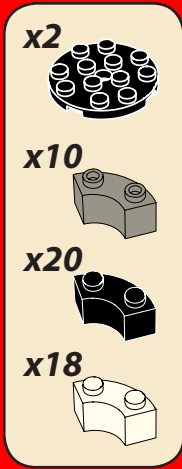
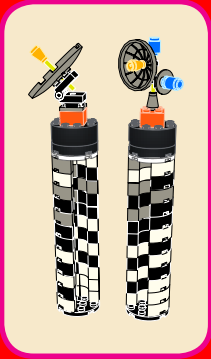



4



x2

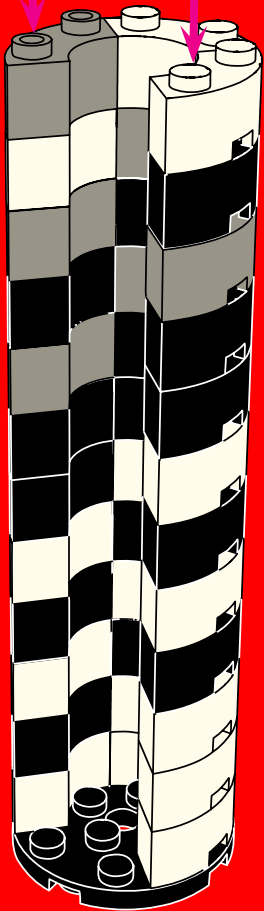

4b

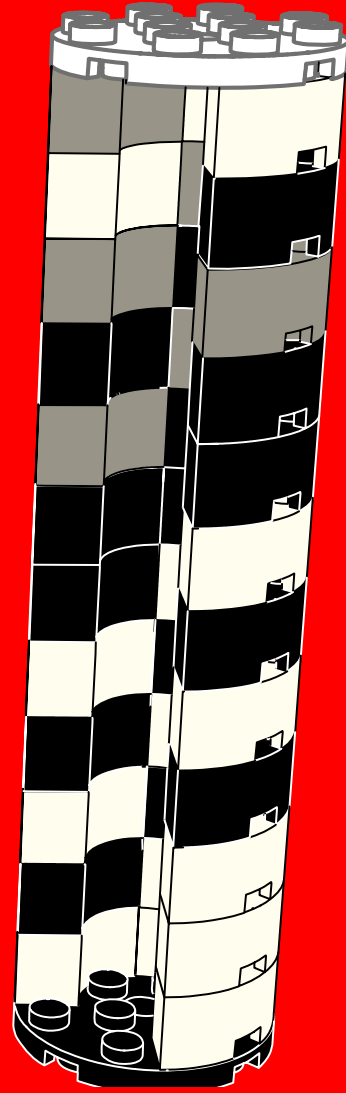
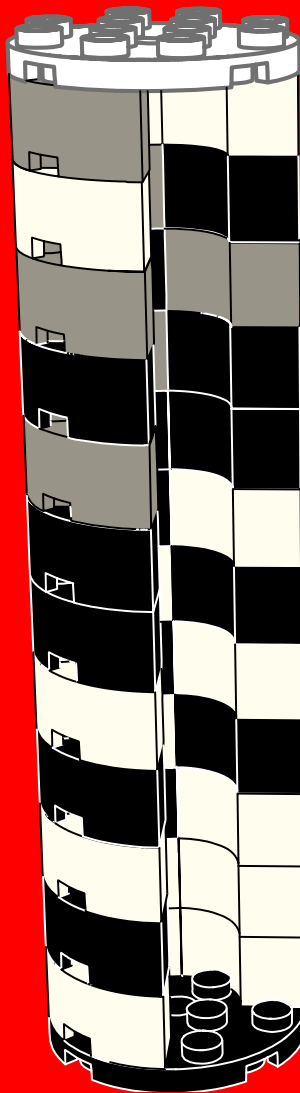

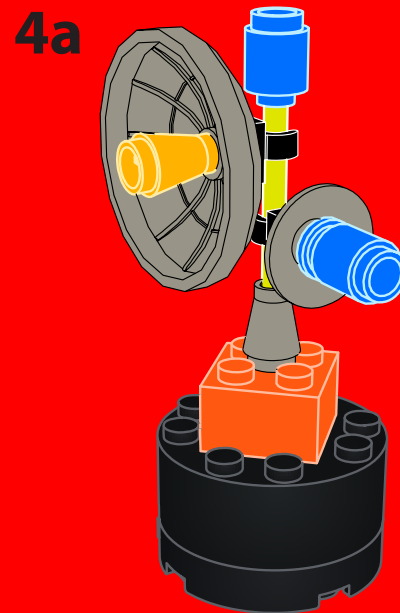
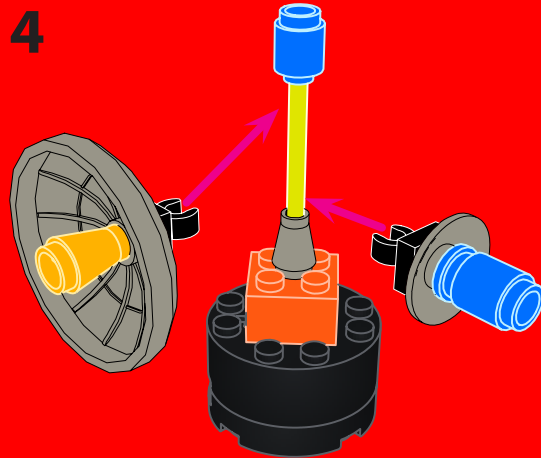
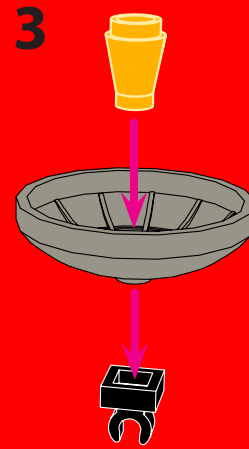
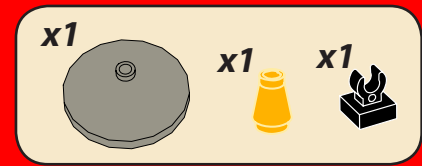
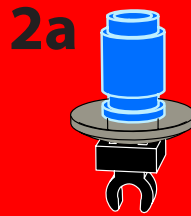
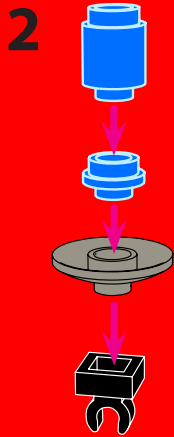
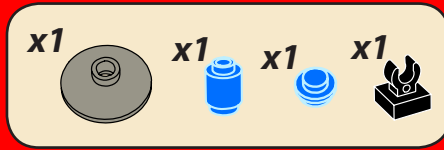
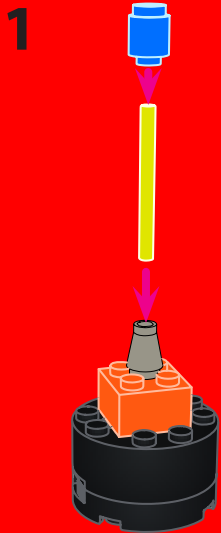
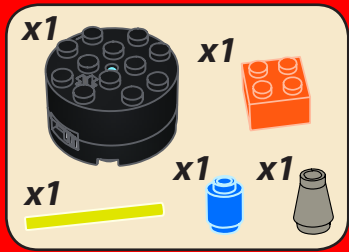

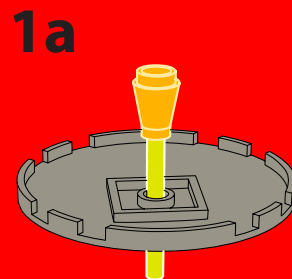
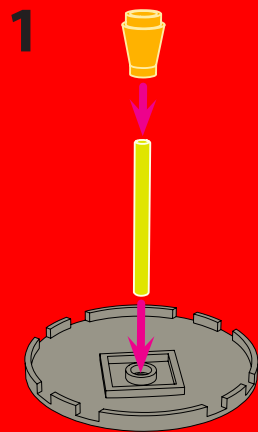
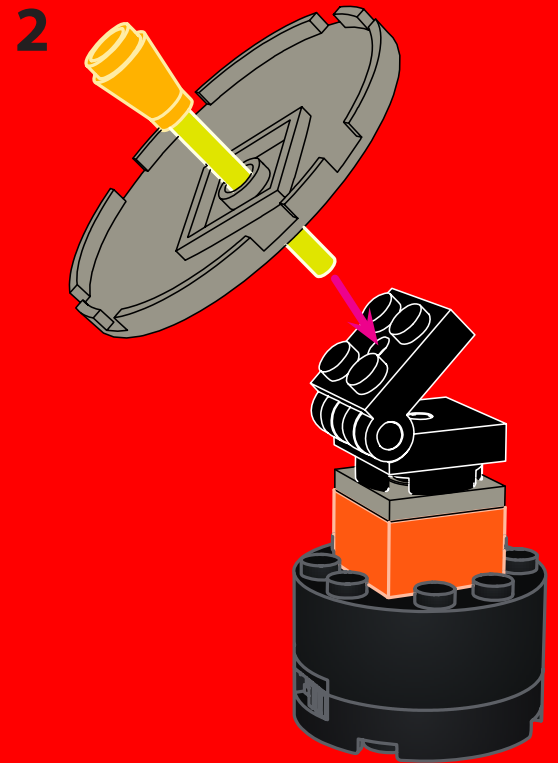
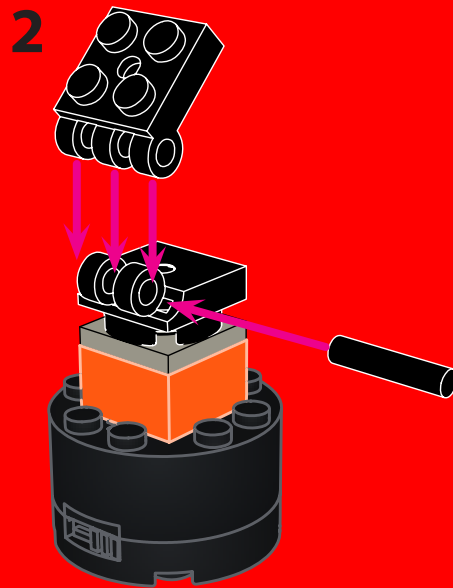
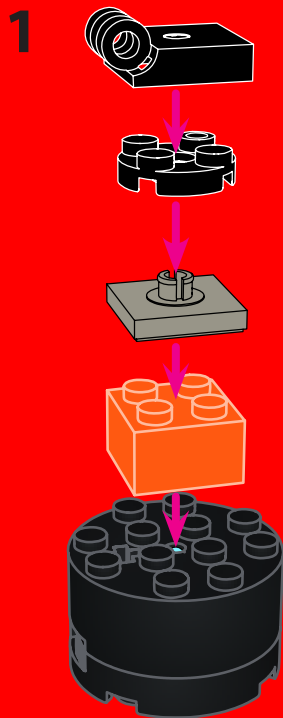
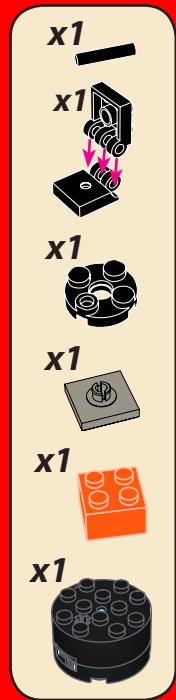

2a

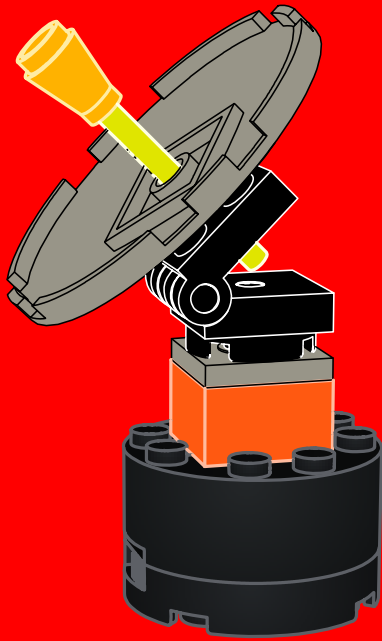

x1

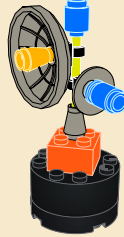

x1

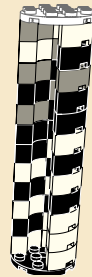
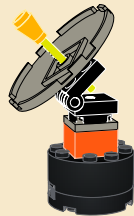

3

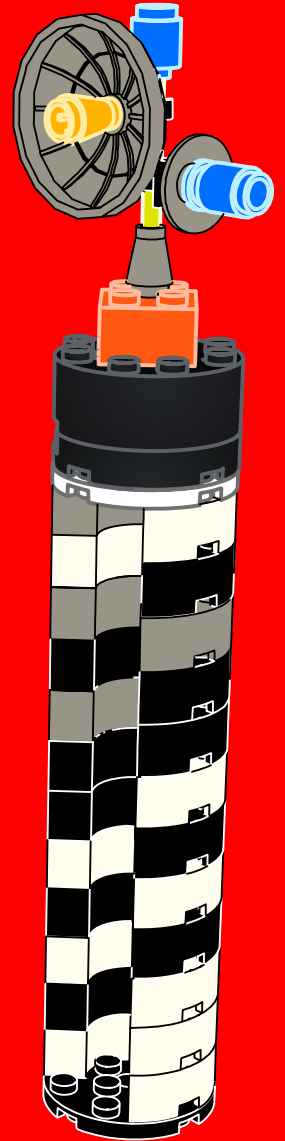
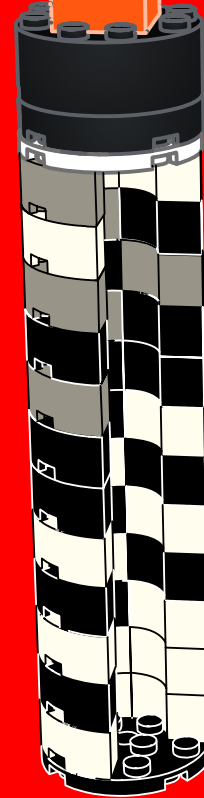
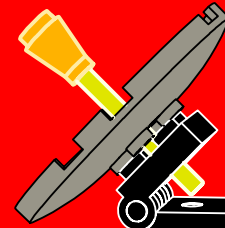

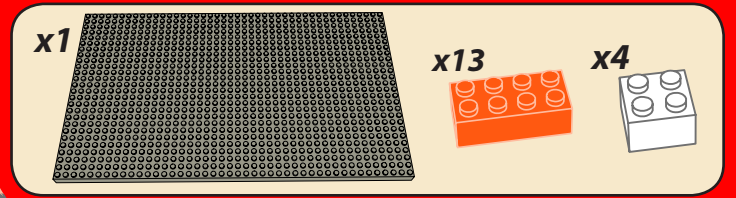
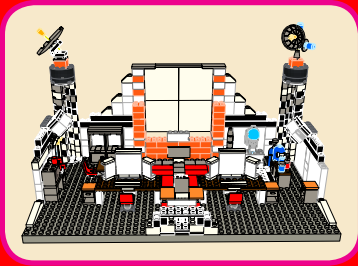

1

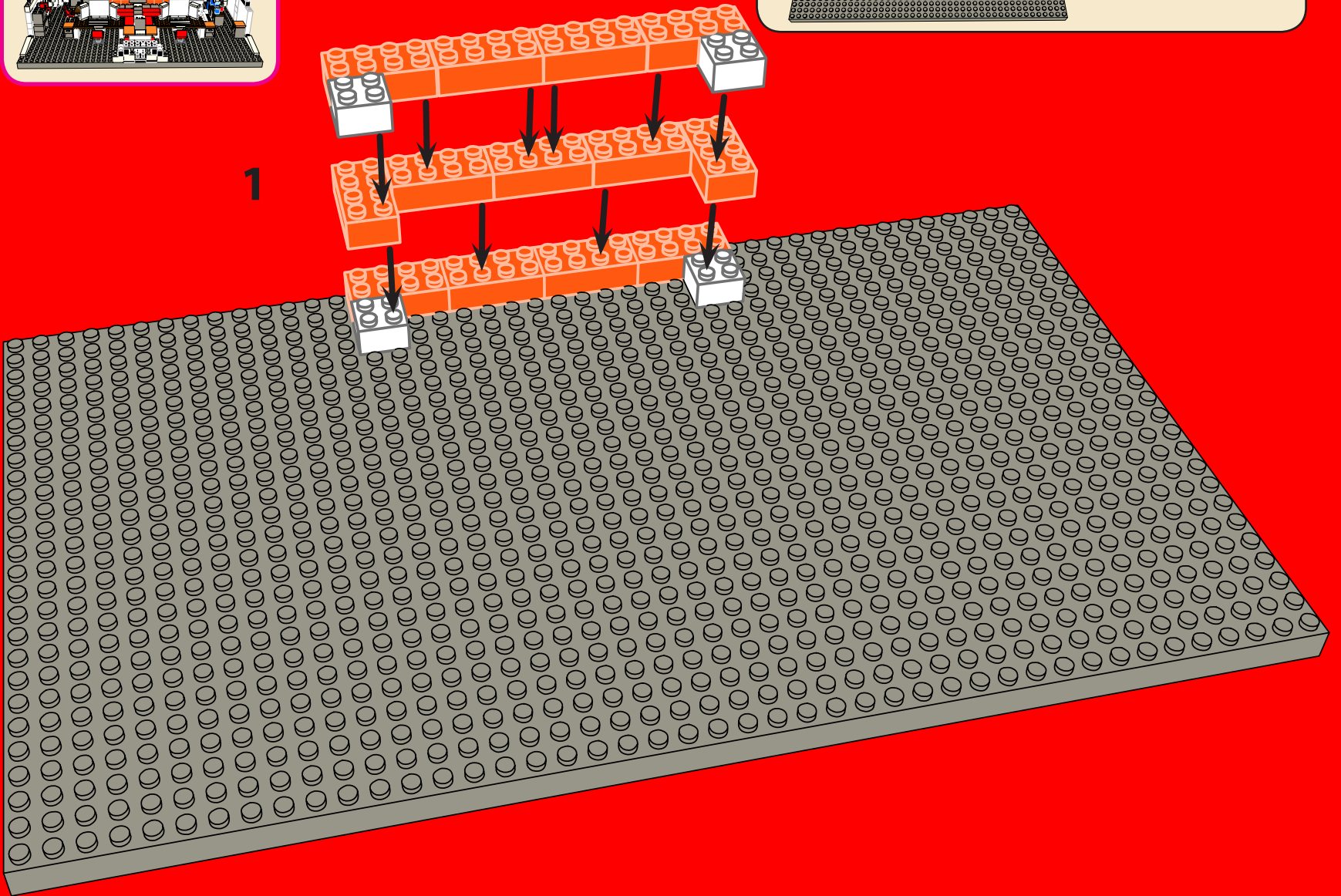

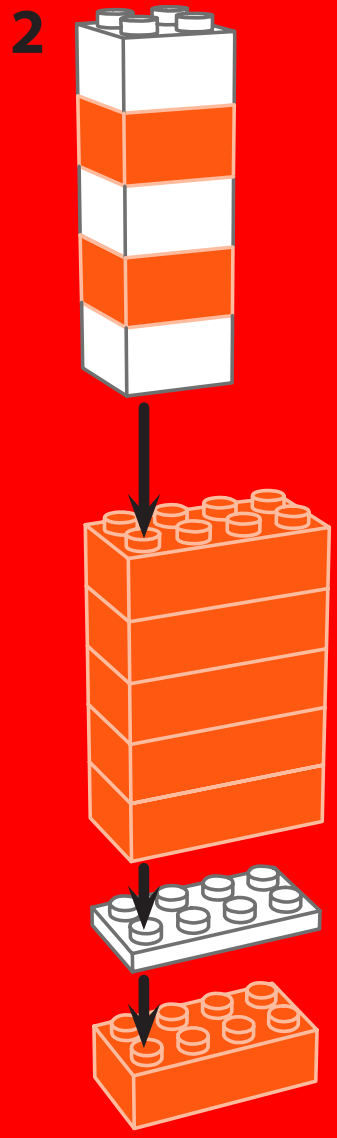
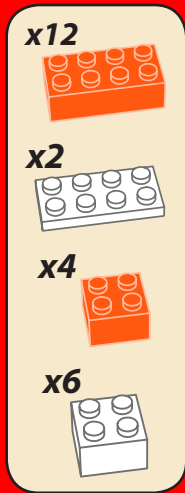

x2

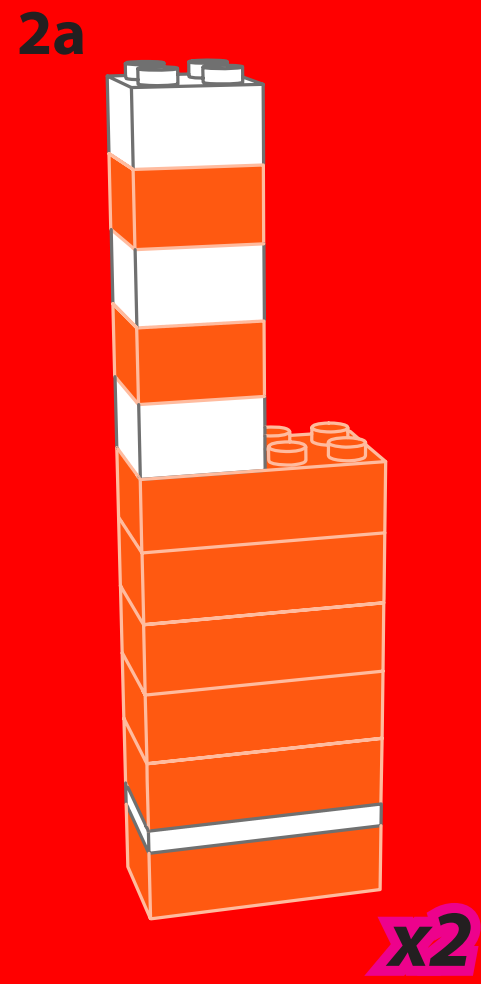

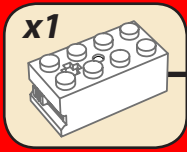

3

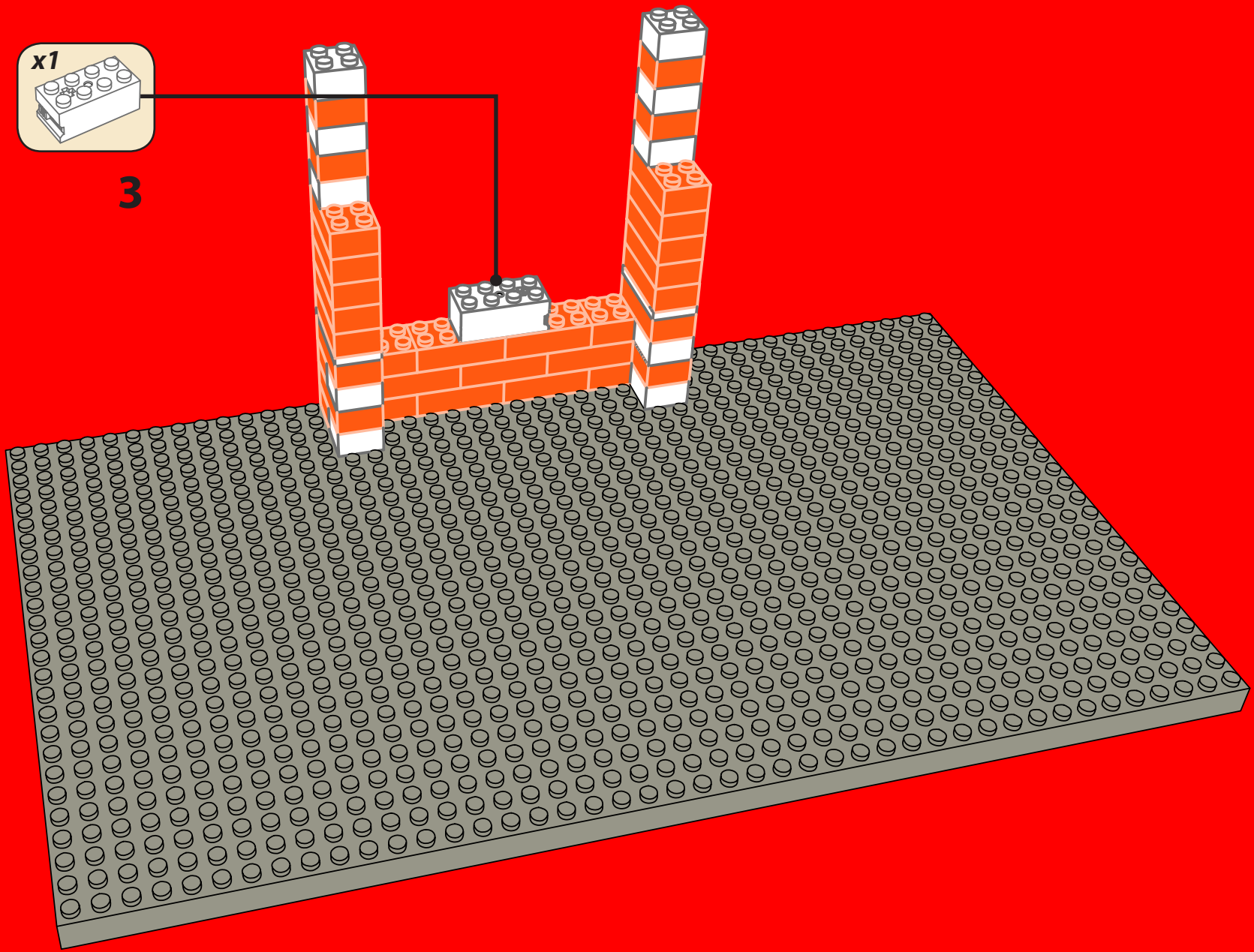

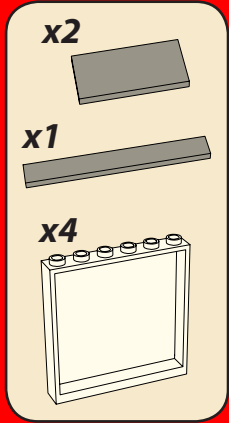

4

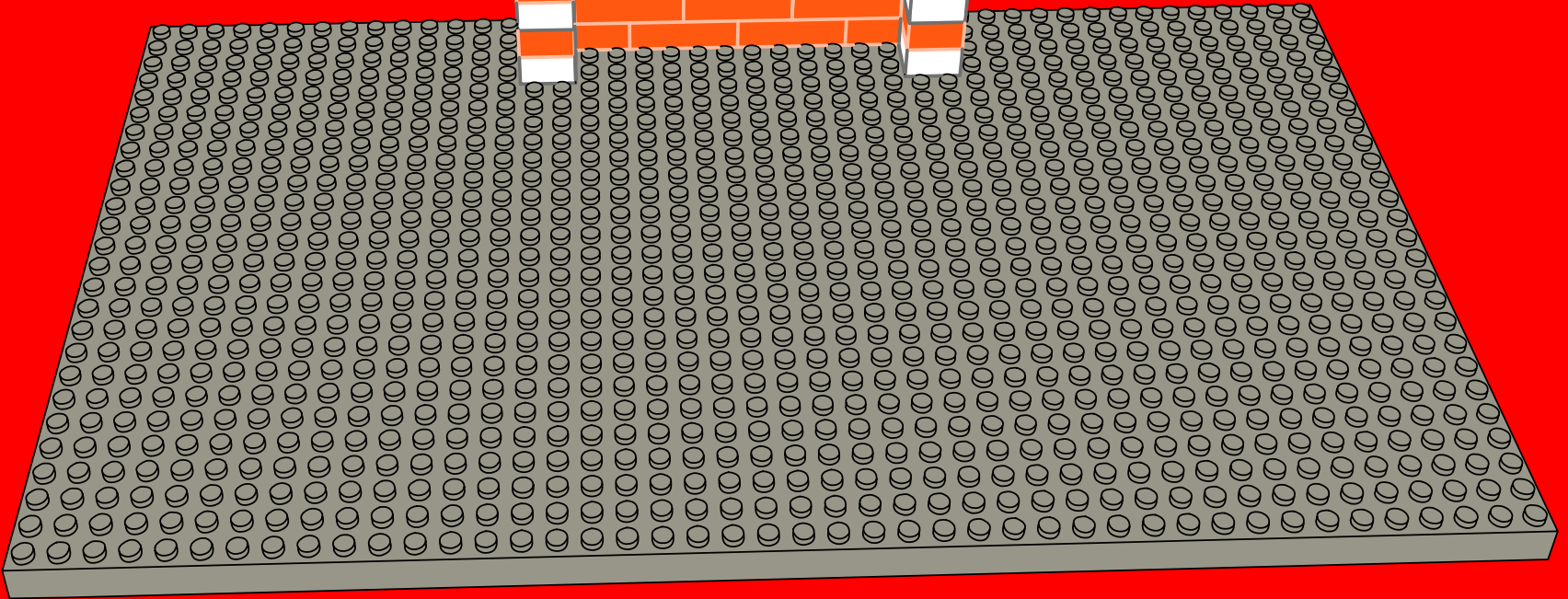
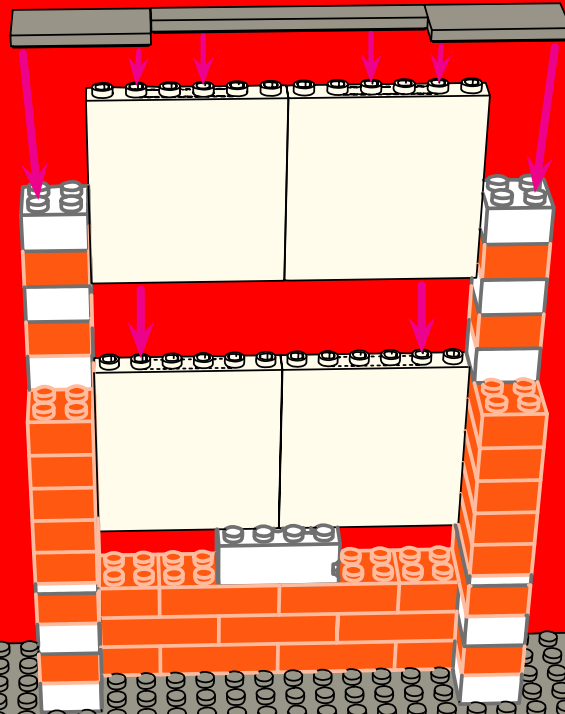

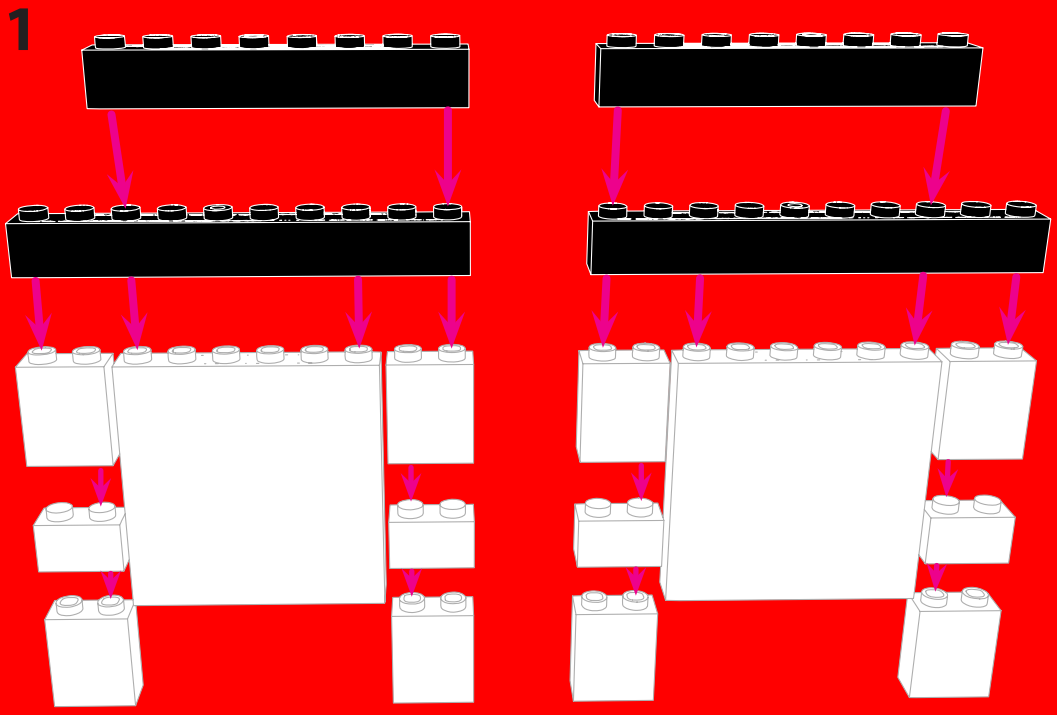
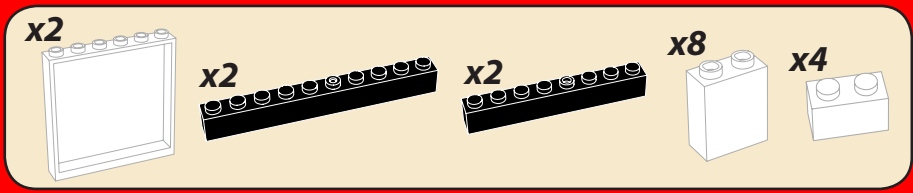

1a

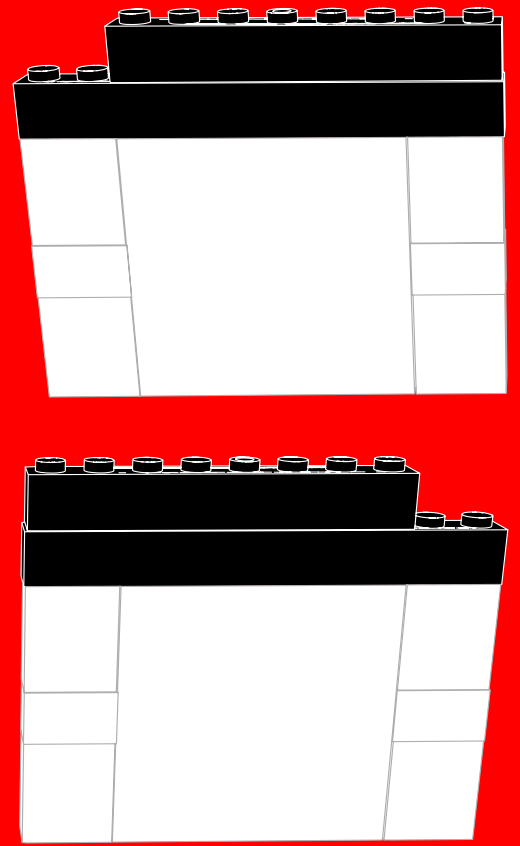

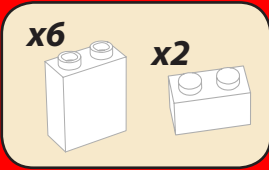

2



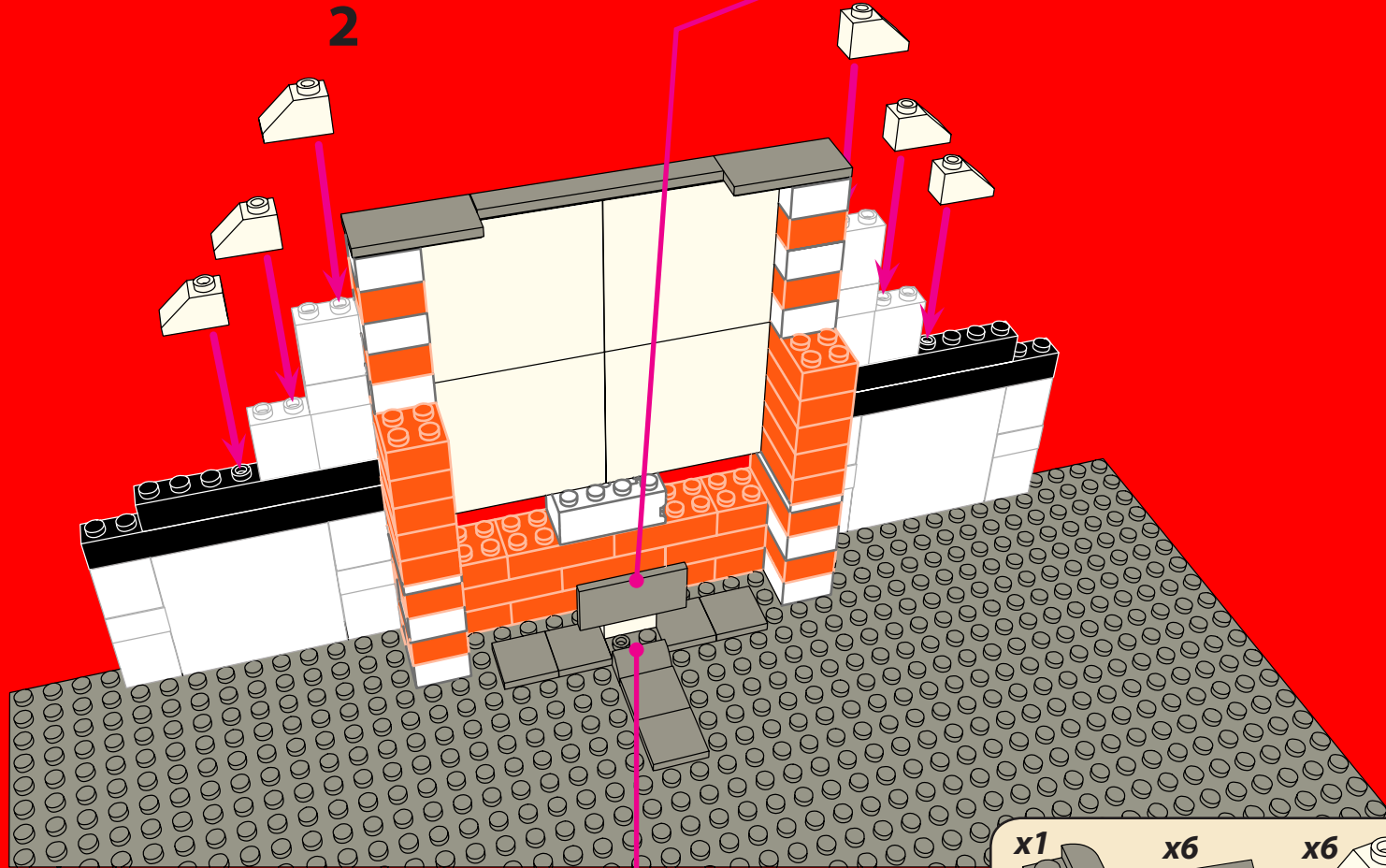
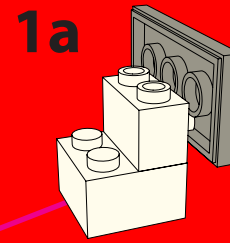
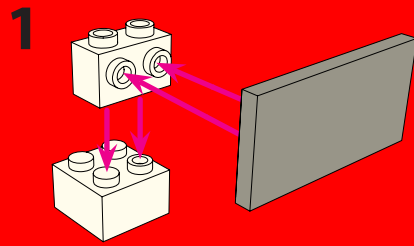
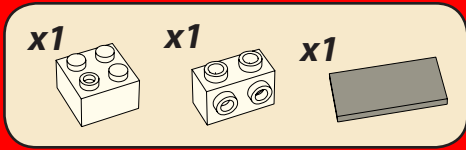



3

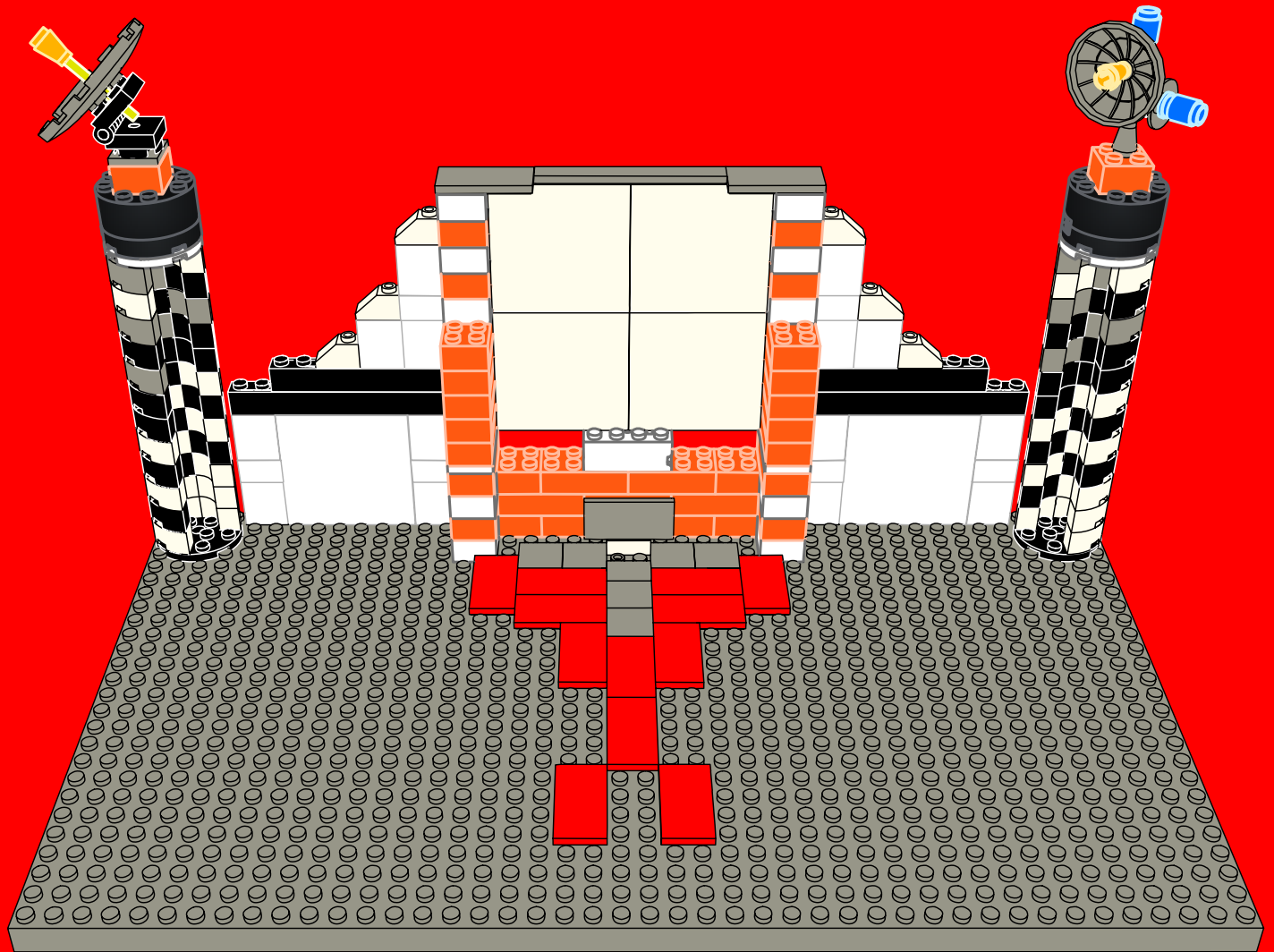

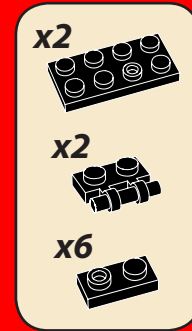
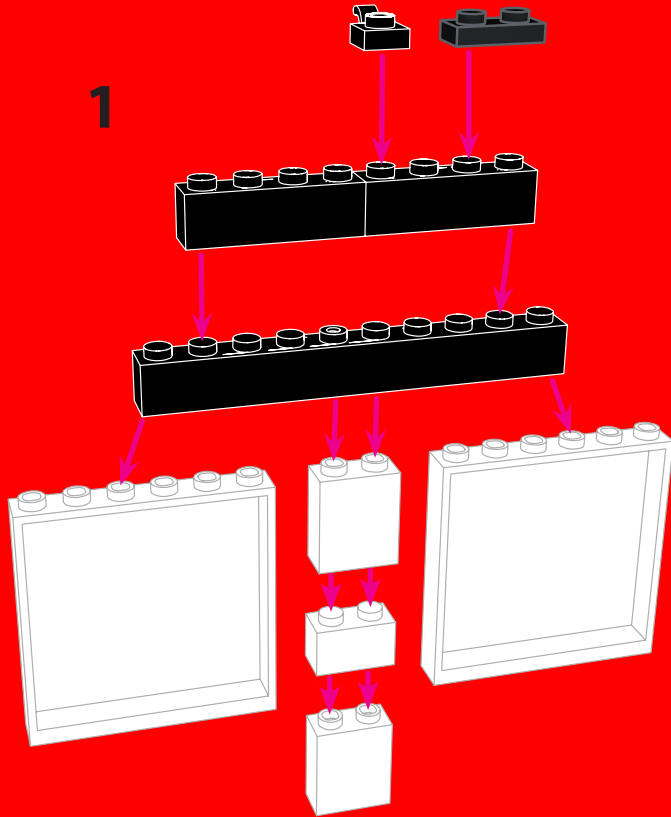
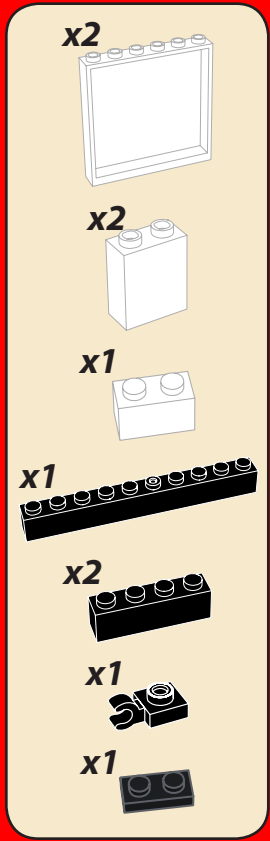

2

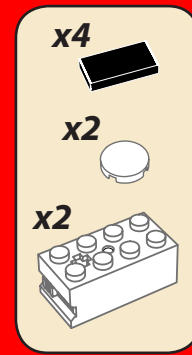
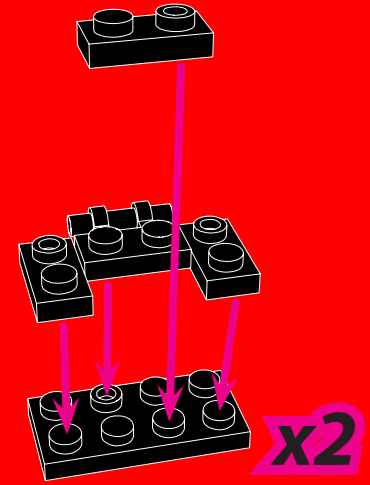

3

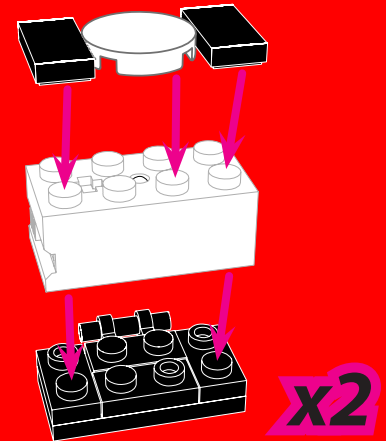

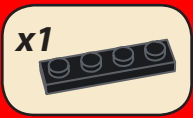

4

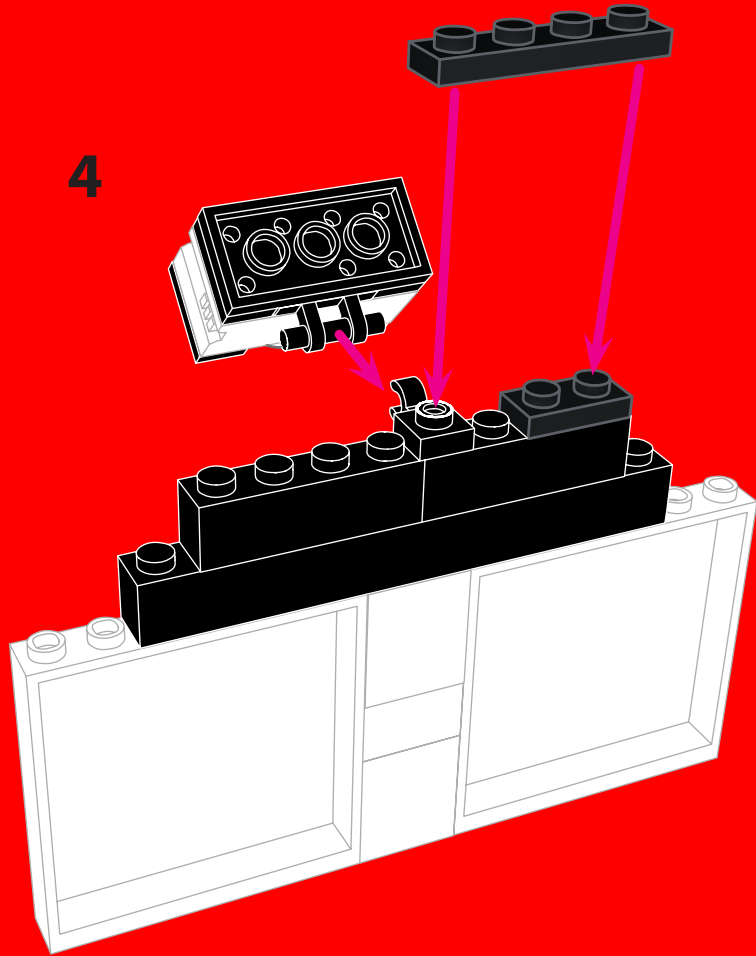

4a

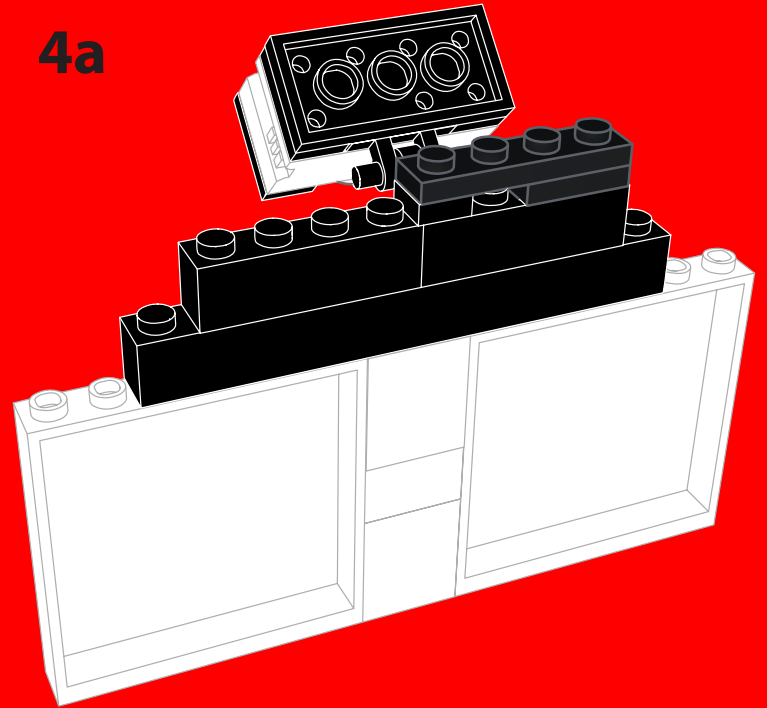

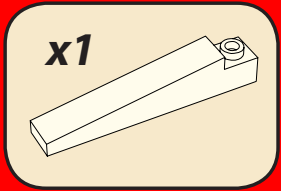

5

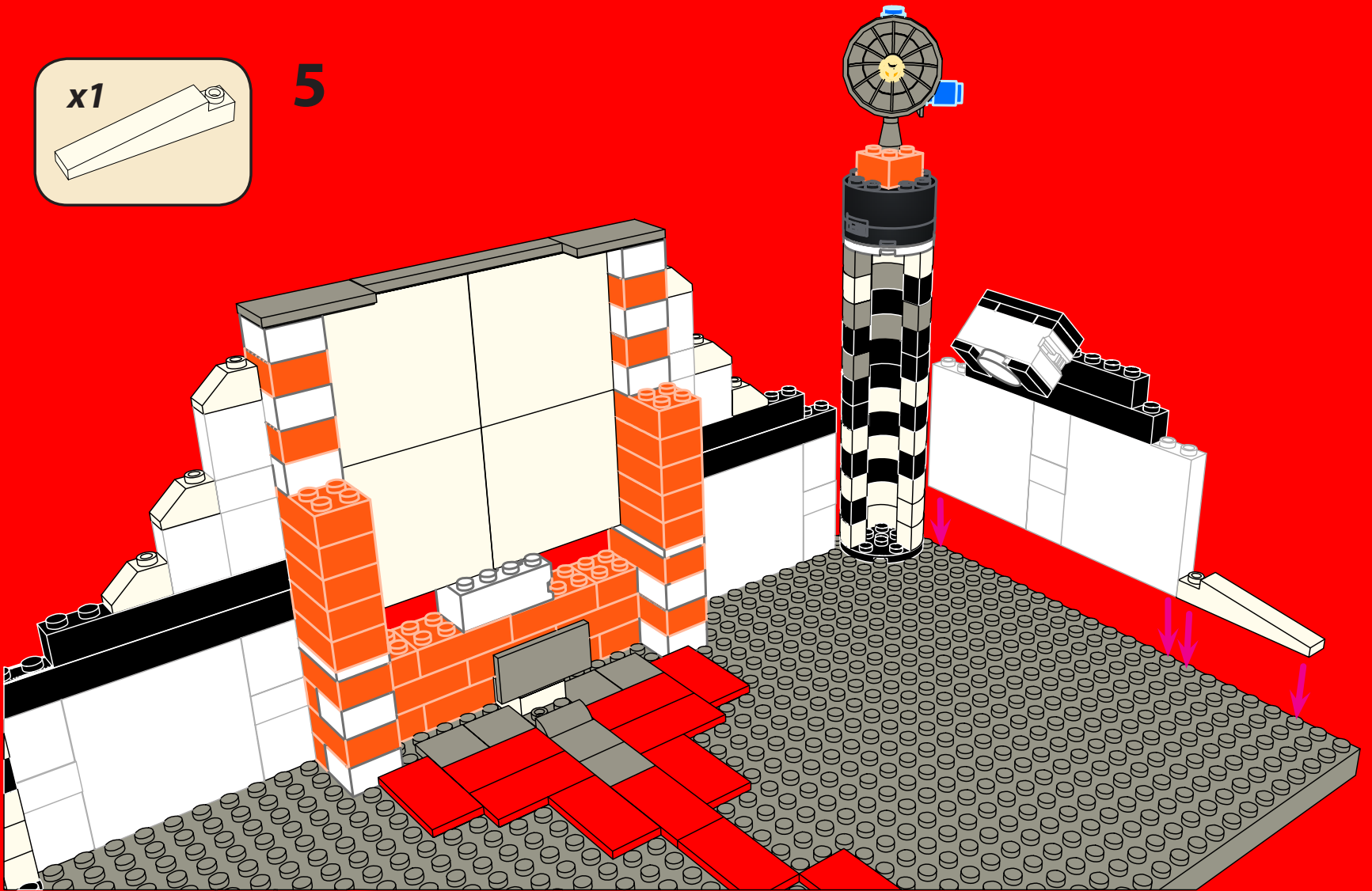

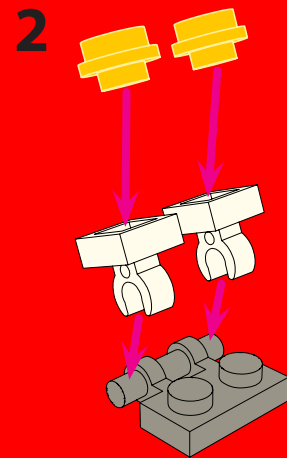
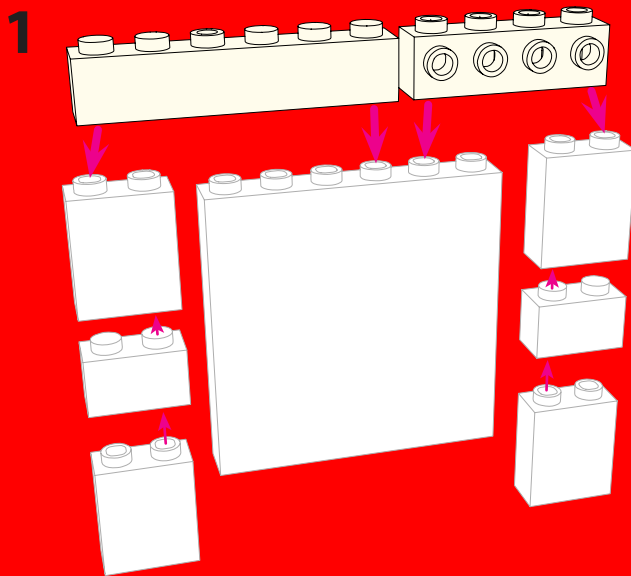
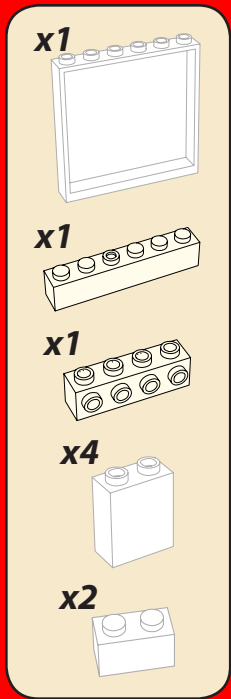
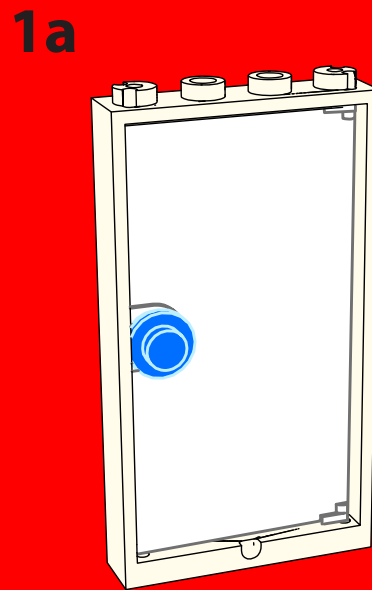
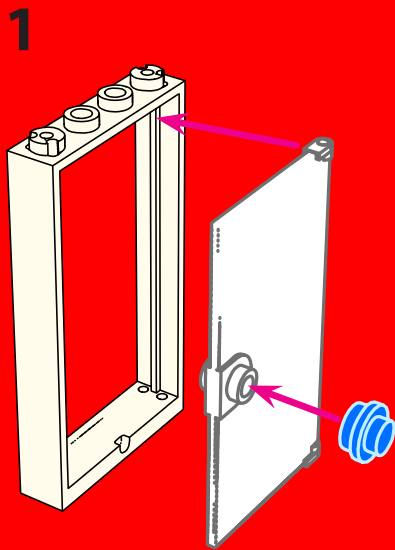
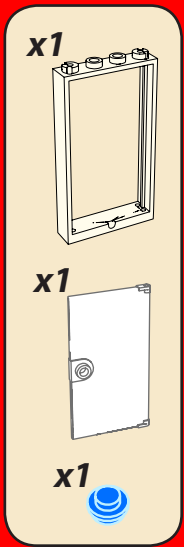

3

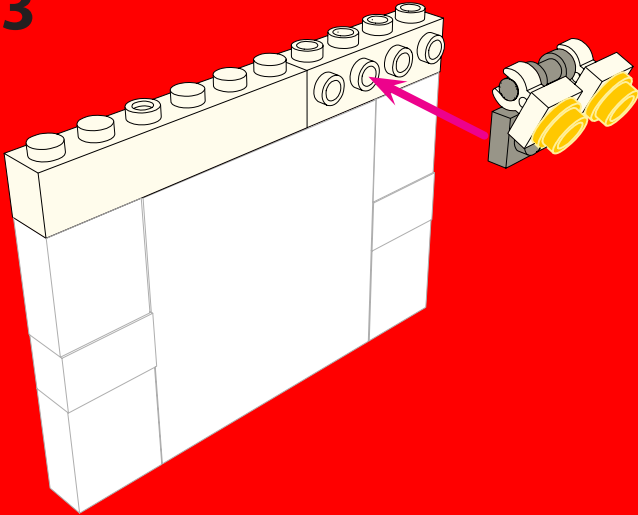

3a

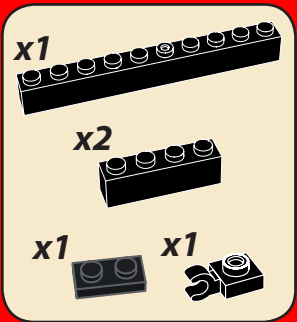
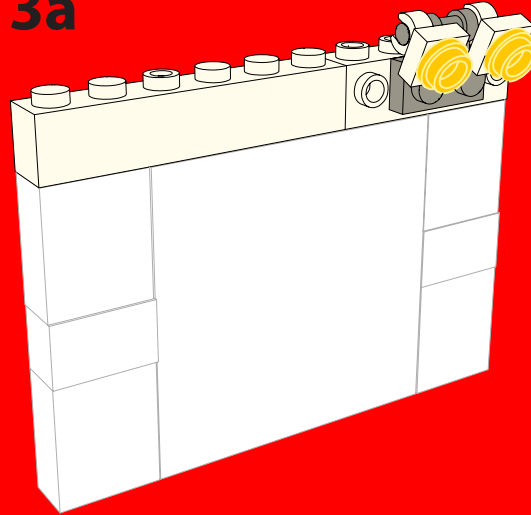

1

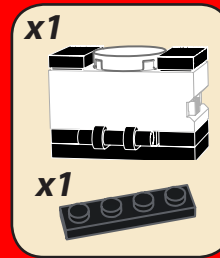
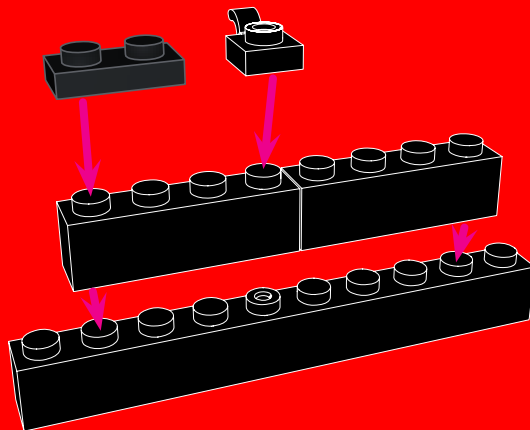

2

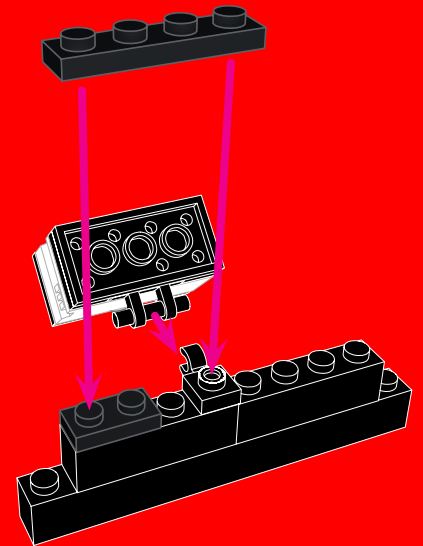

3

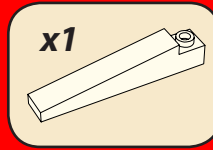
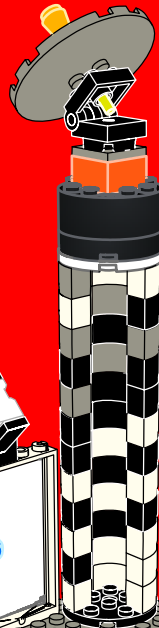
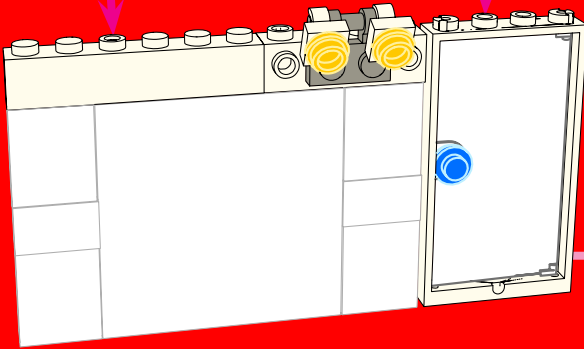
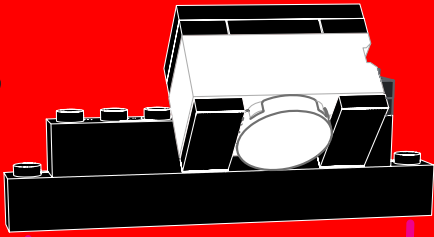

4

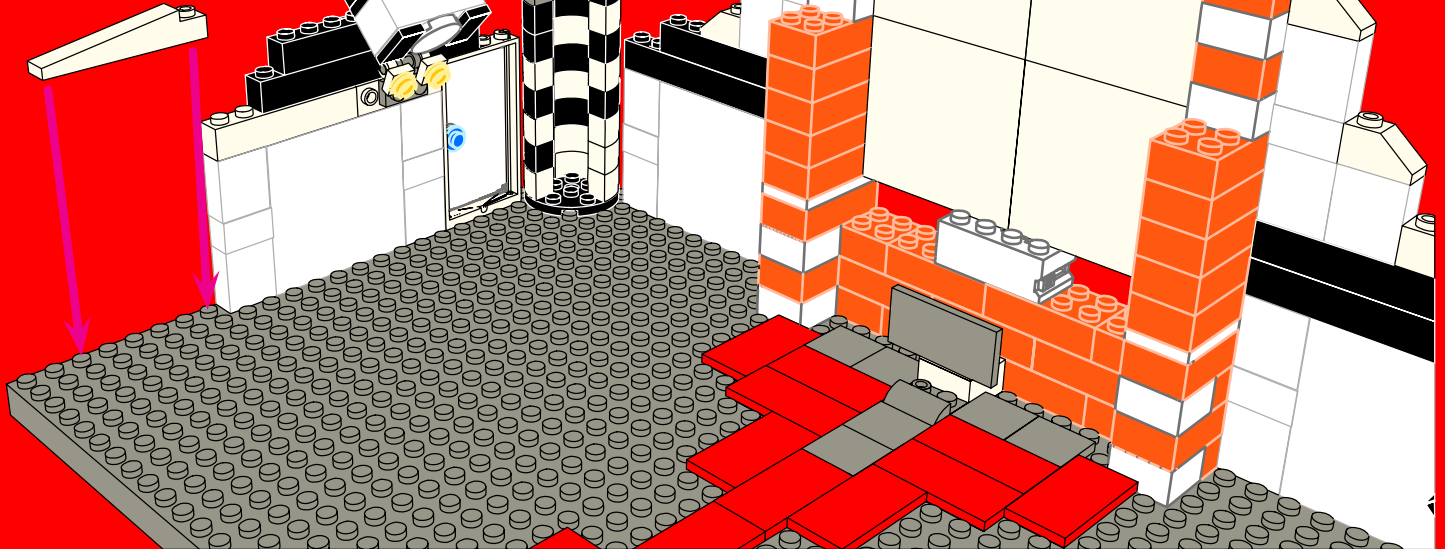

- x2
- x2
- x2

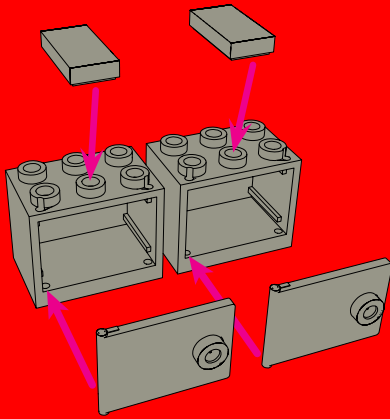

1

- x1
- x2
- x4

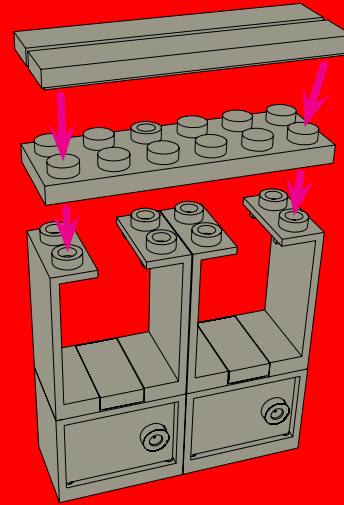

2

2a

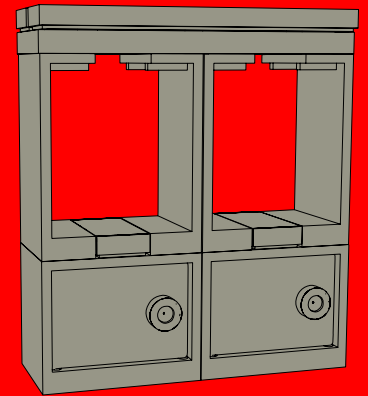

- x1
- x1
- x1
- x2

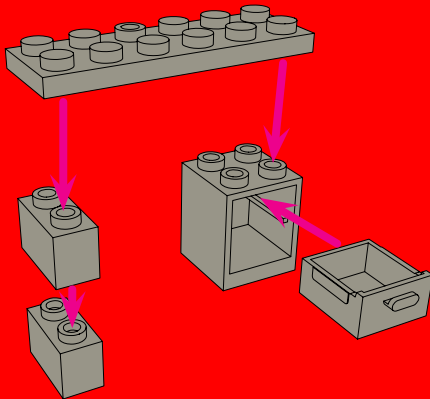

1

- x1
- x1

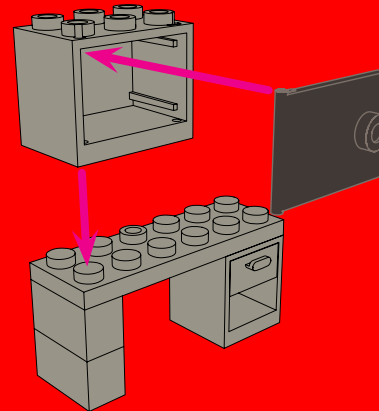

2

- x1
- x1
- x1
- x1
- x1

3

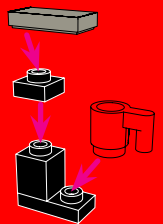

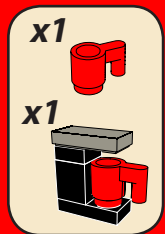

4

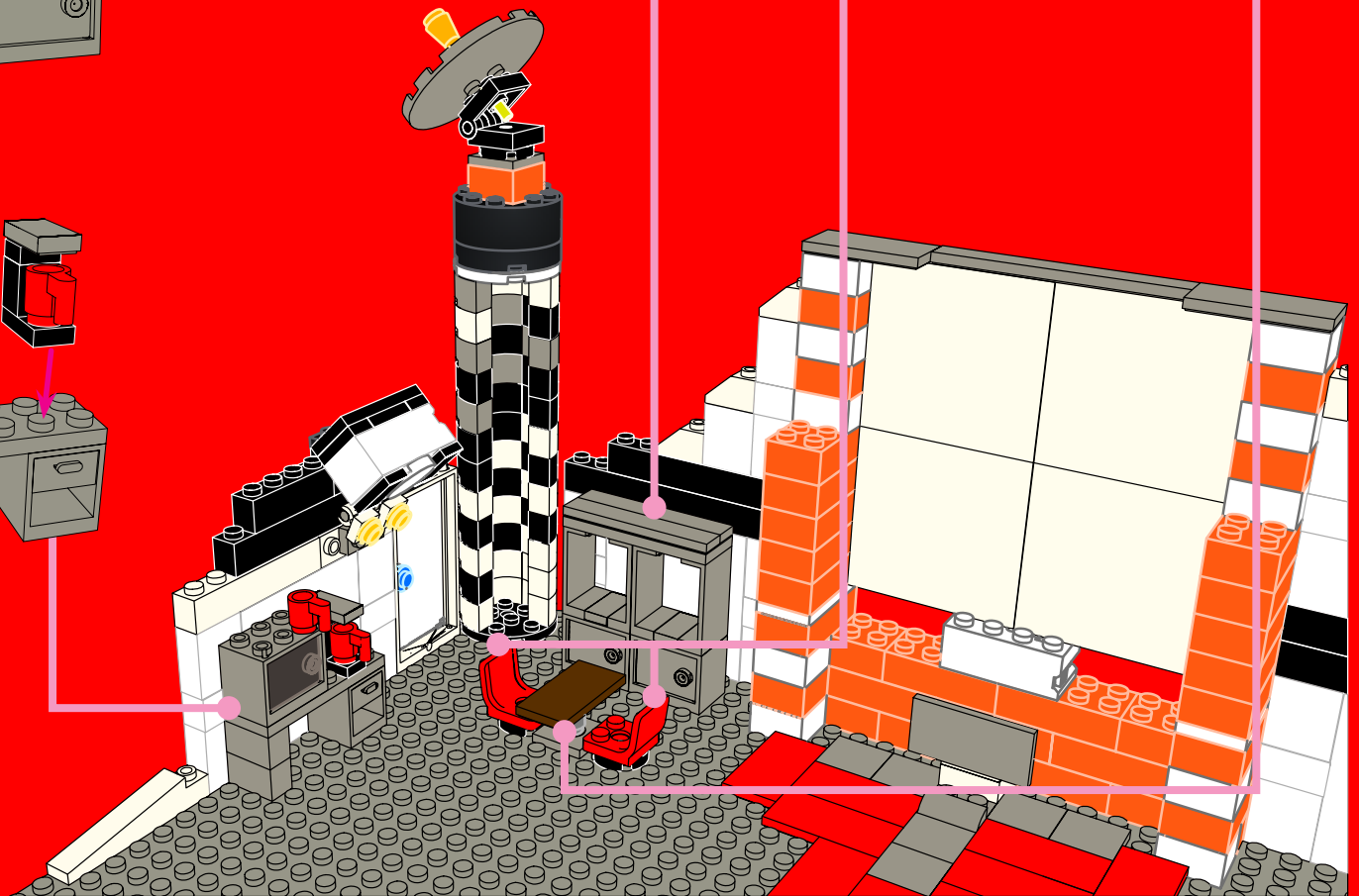
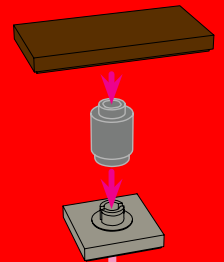
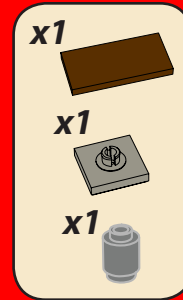
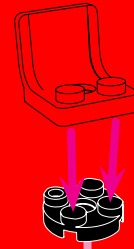
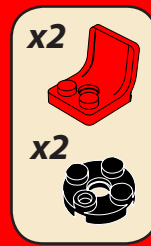
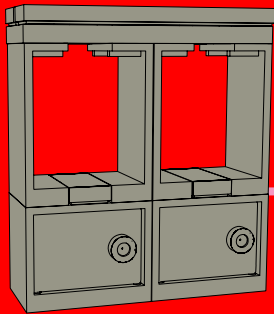
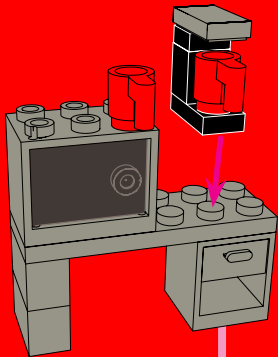



1

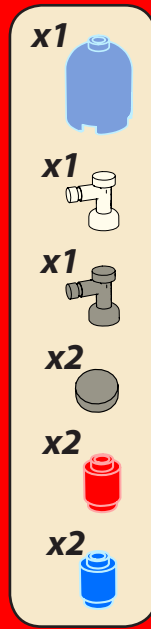
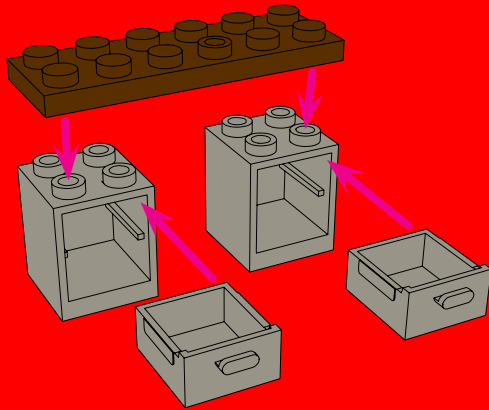

2

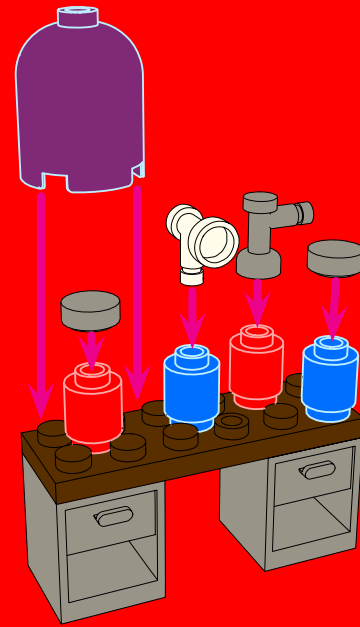

1

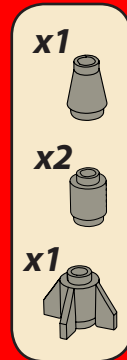
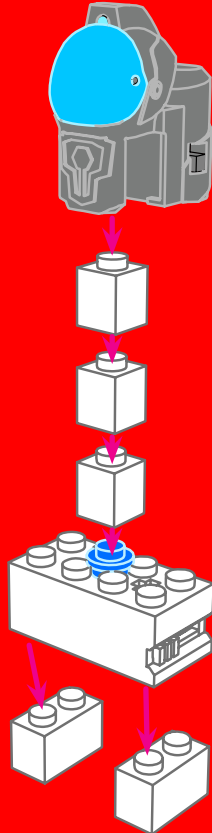
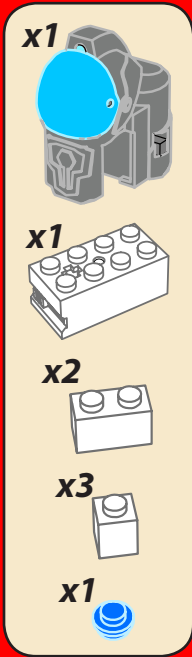

1

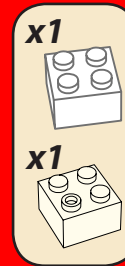
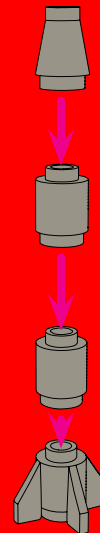

2

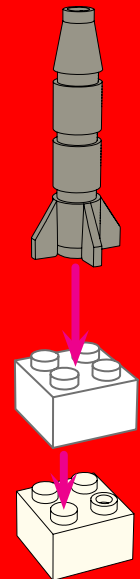

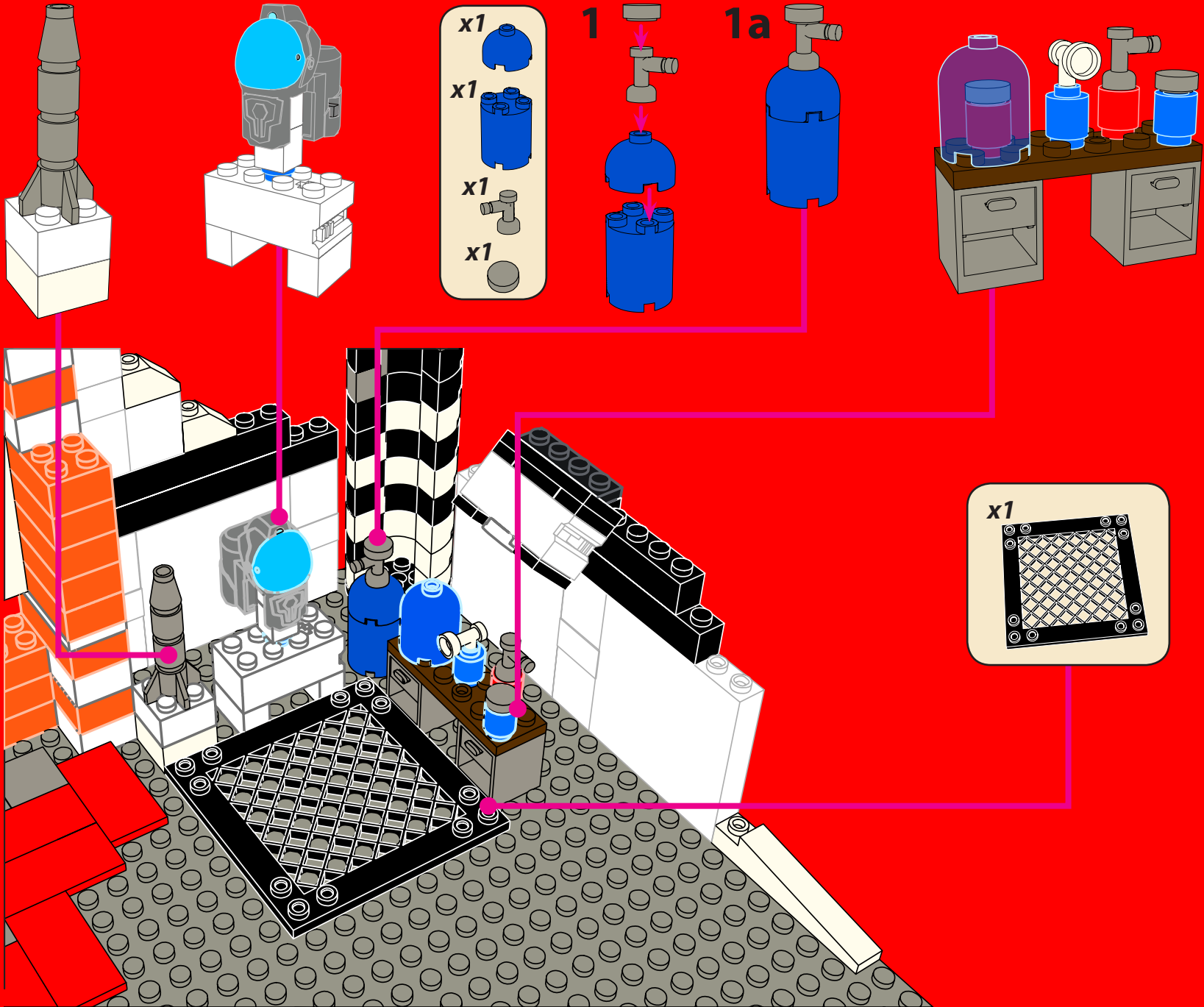

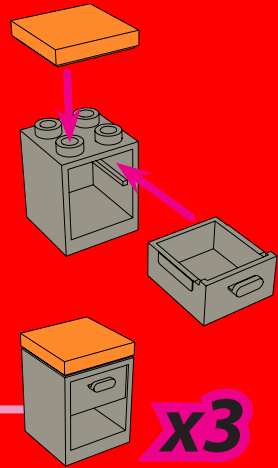
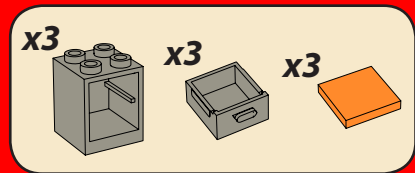
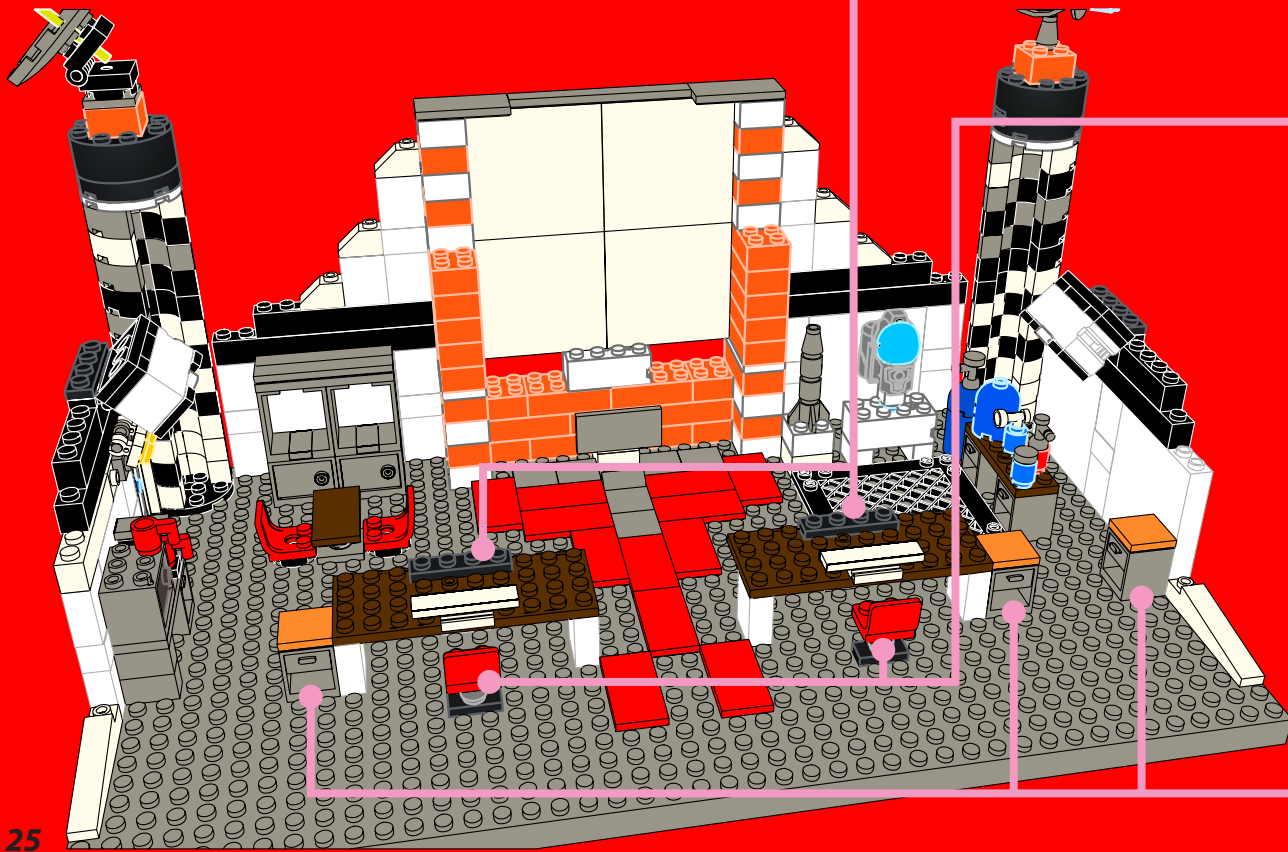
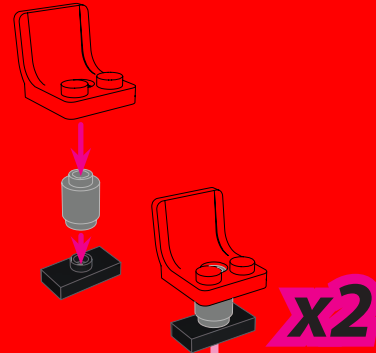
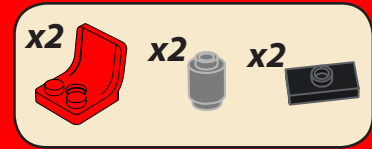
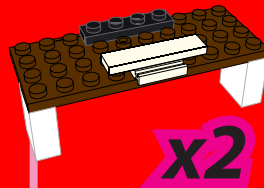
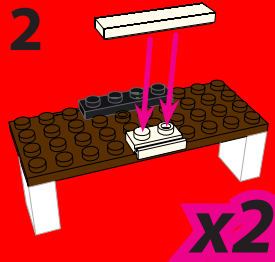
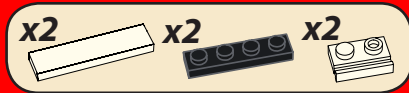
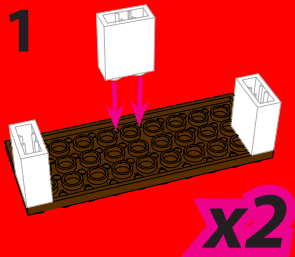
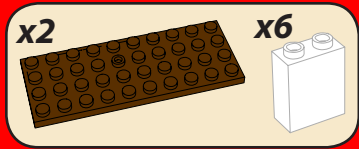



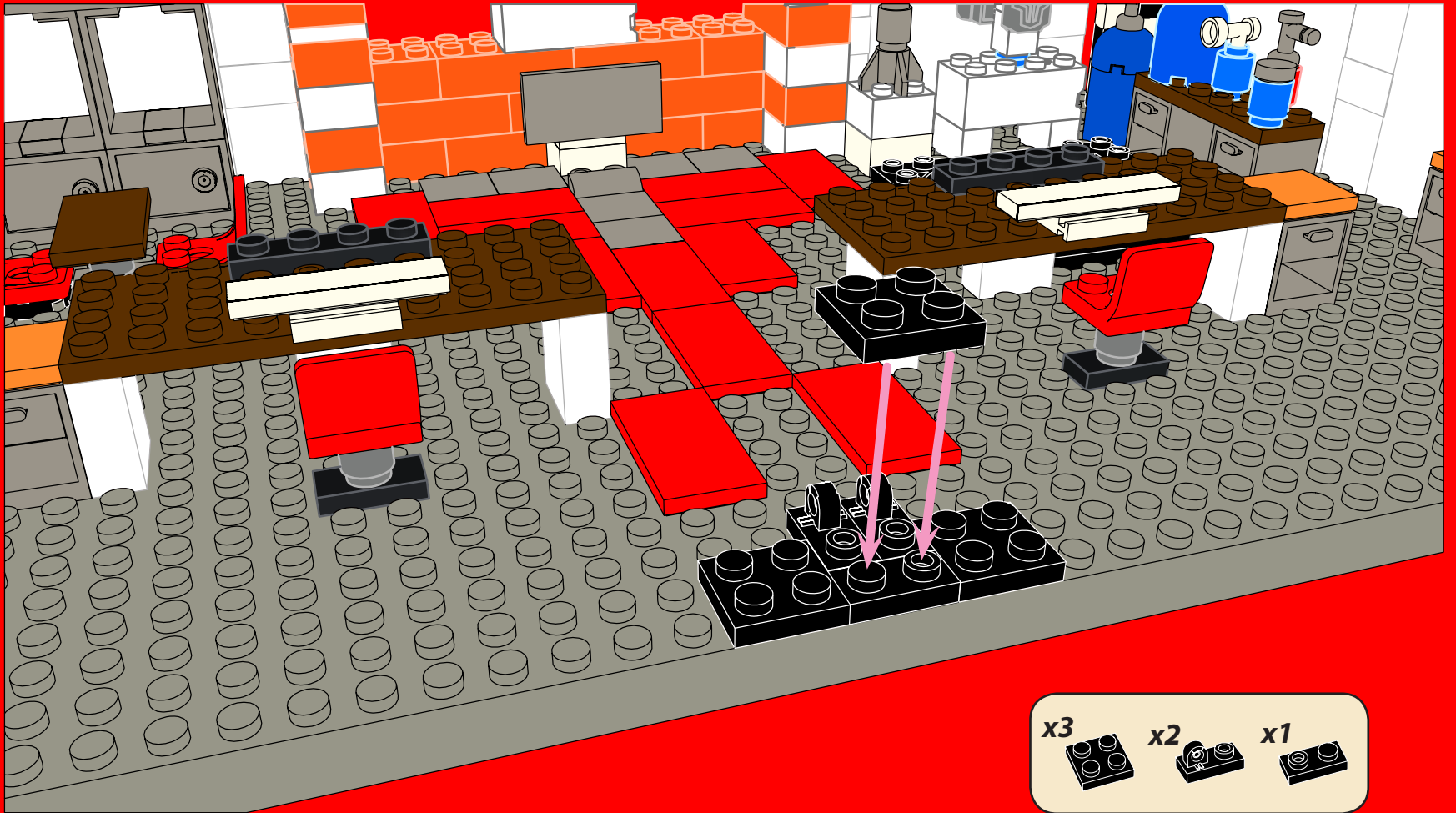

3



x3 x2 x1

This block contains a list of LEGO parts required for step 3. It includes three 1x3 black plates, two 1x2 black plates with a hole, and one 1x2 black plate.

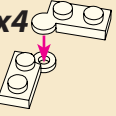
- x2**

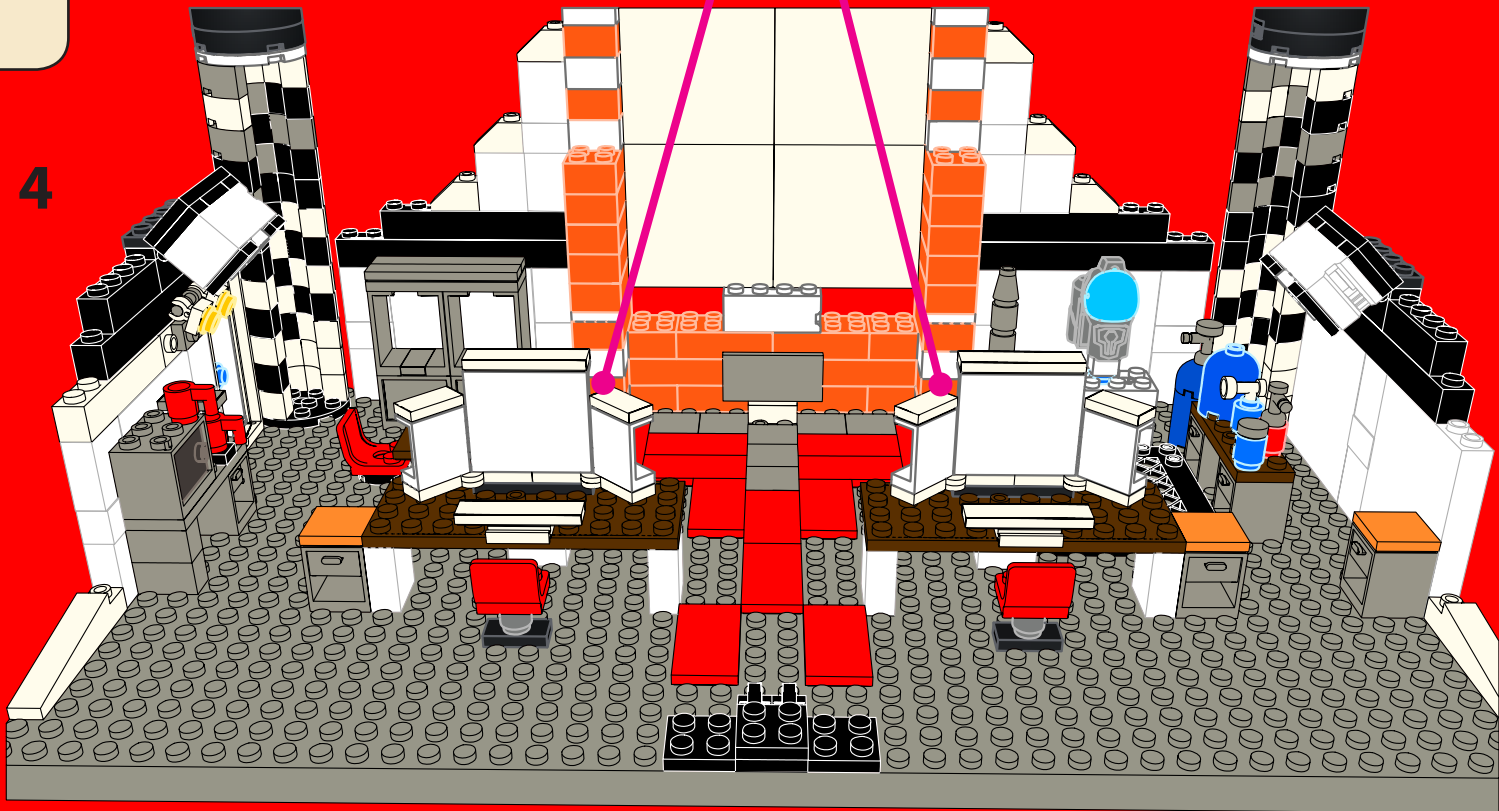
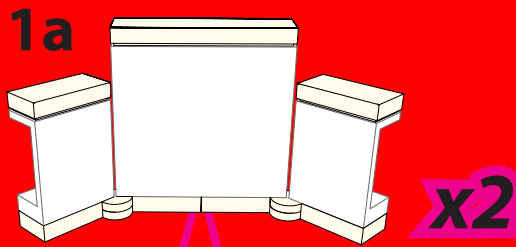
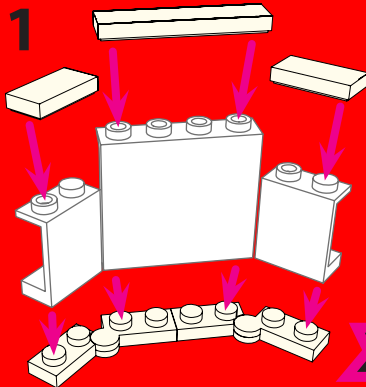
- x4**

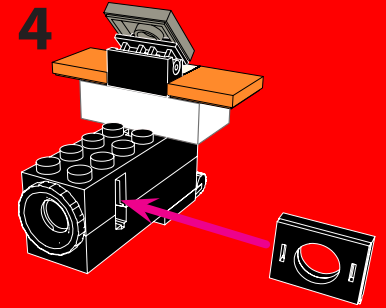
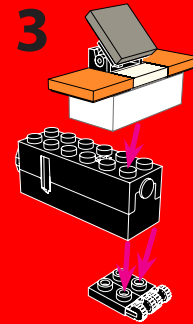
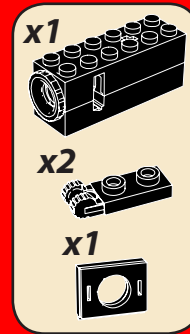
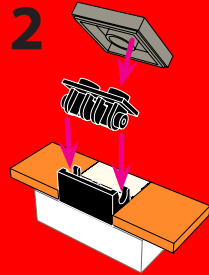
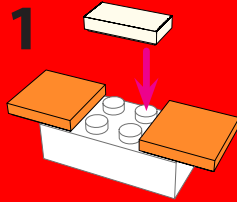
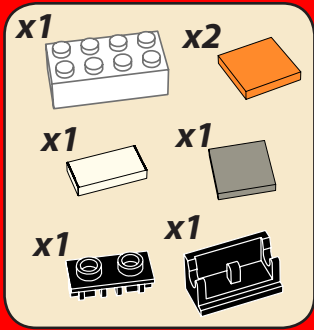
- x2**

- x4**

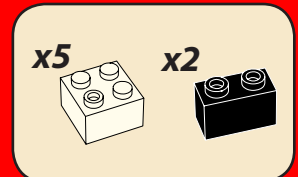
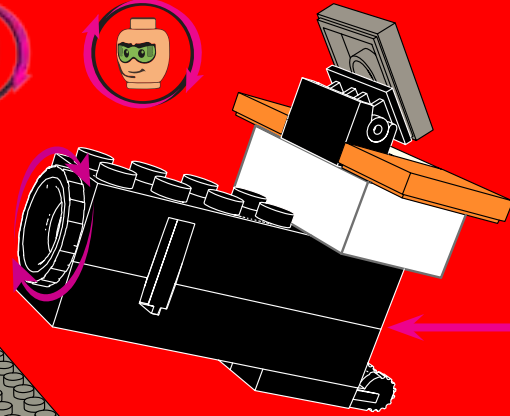
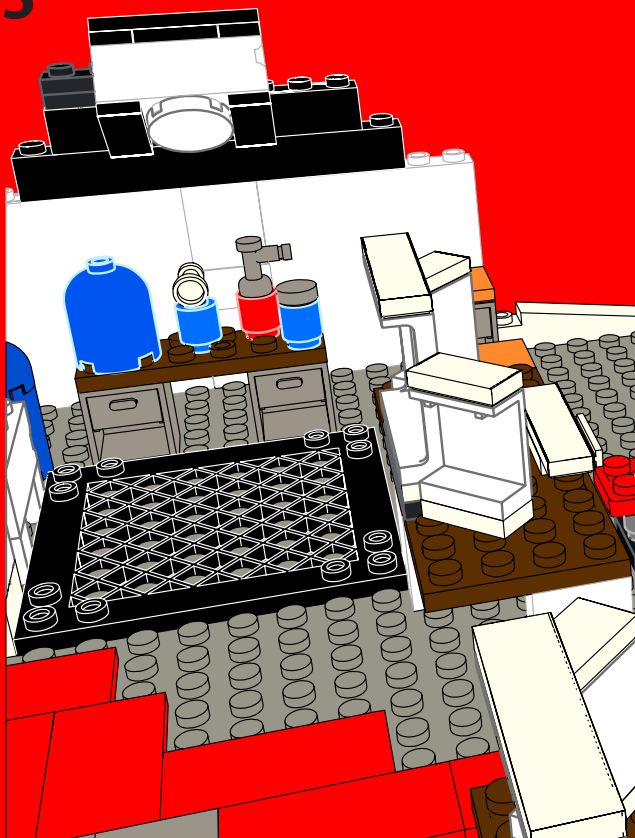
- x4**





5



5a

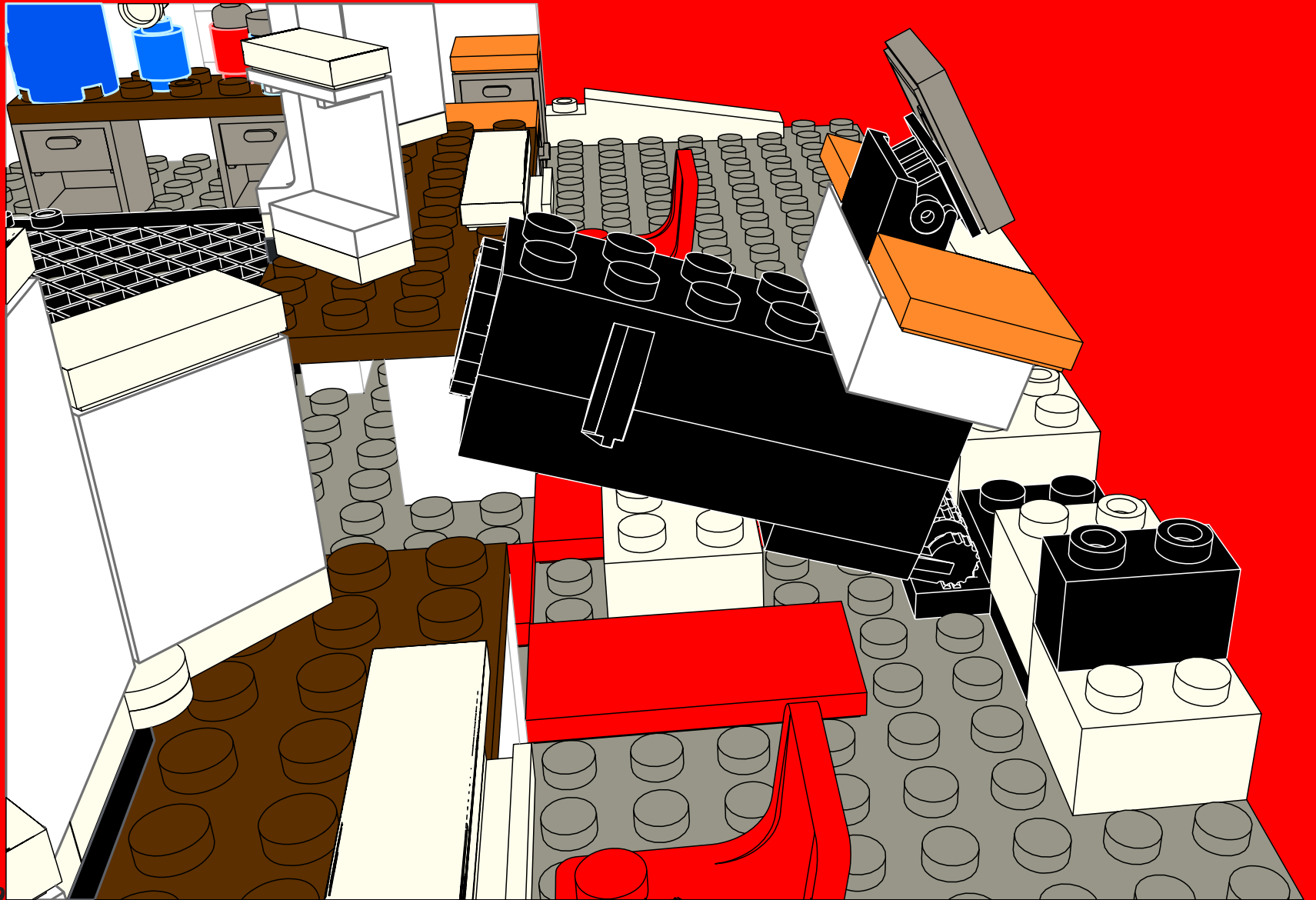

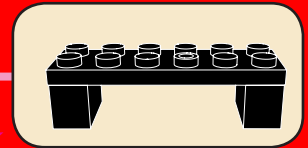
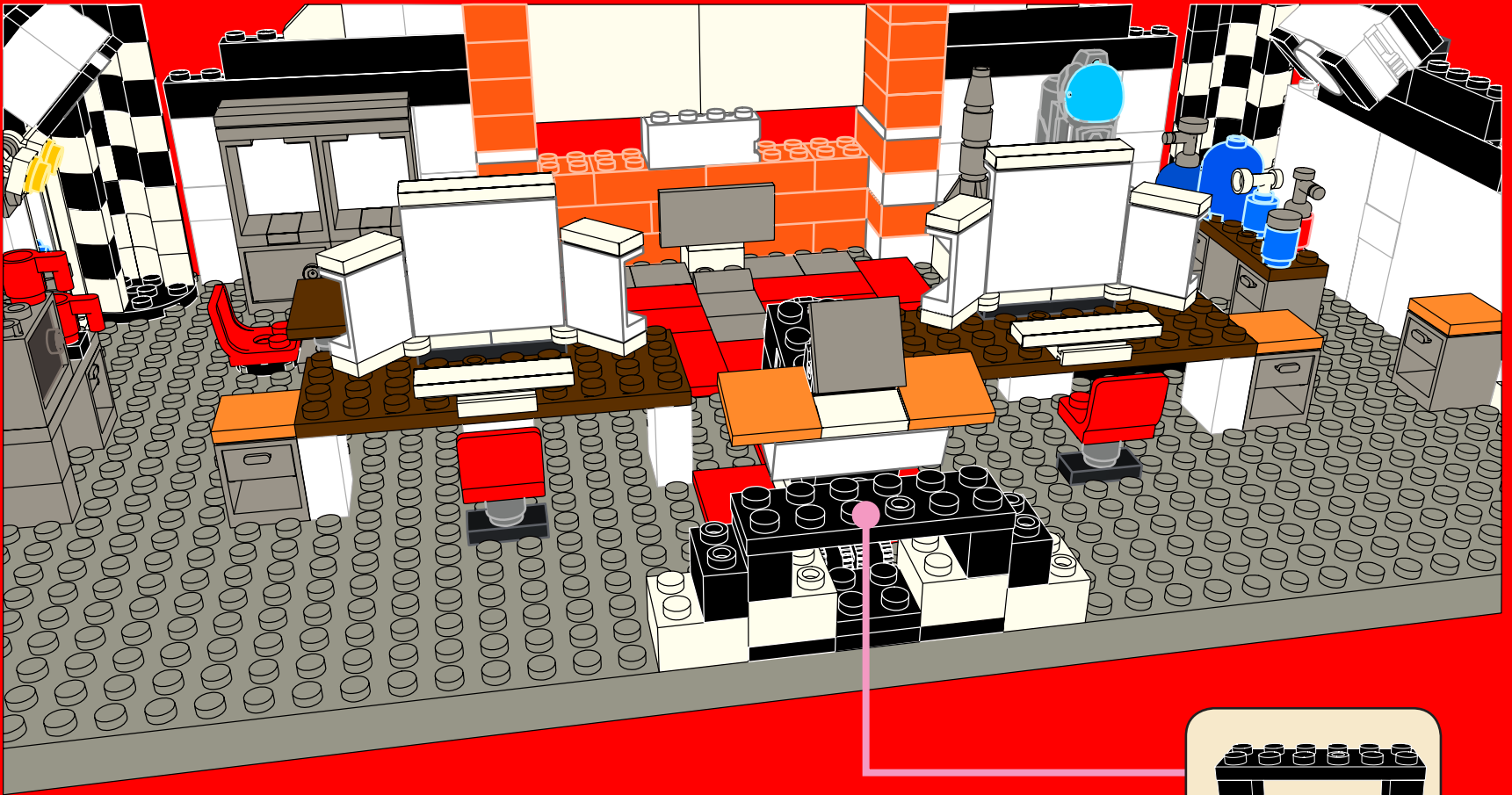

6

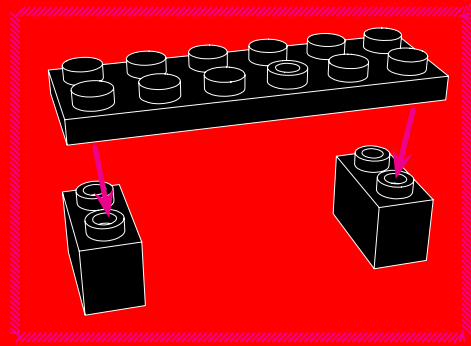

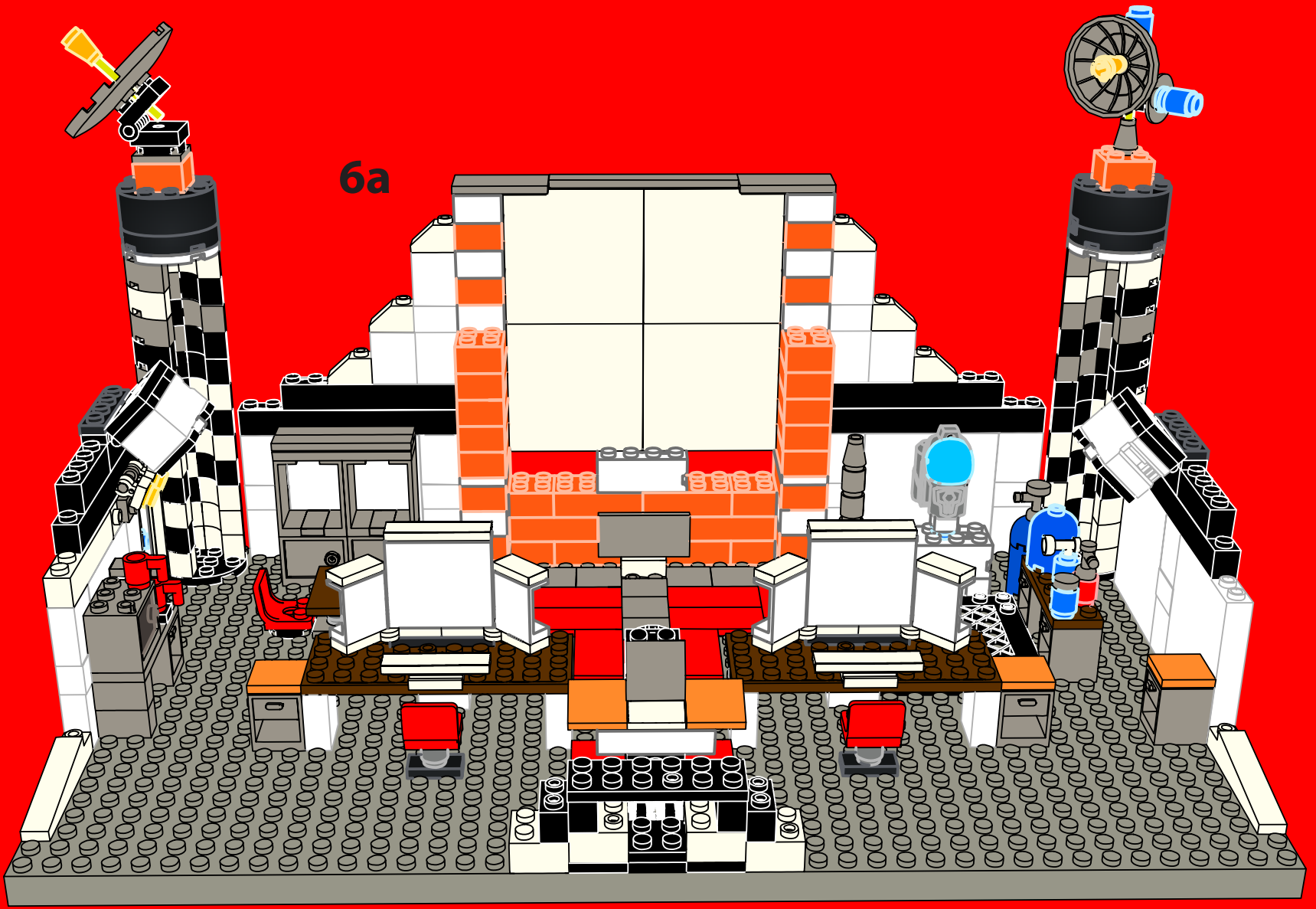

6a

x1

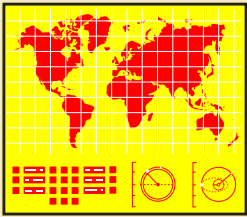

x1

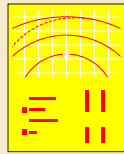

x1

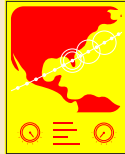

x1

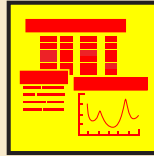

x1

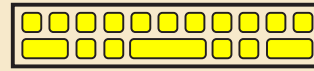

x1

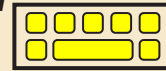

x1



1



x1

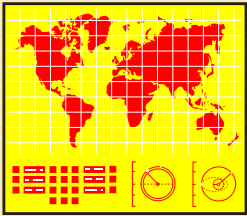

x1

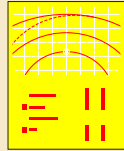

x1



x1



x1



2

