



ECO

Switch

Bilge Pump

Control Switch

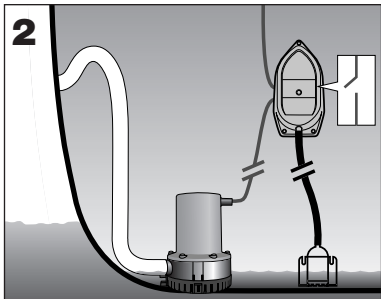
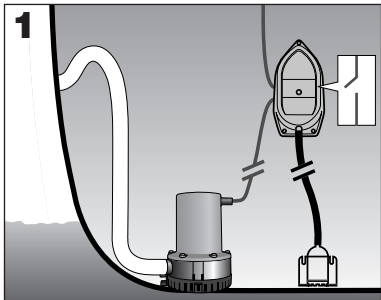

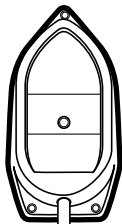

Hose Kit
Part No.
M-1858

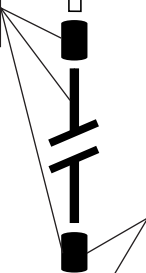

Air Bell Kit
Part No.
M-1859

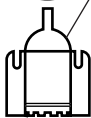

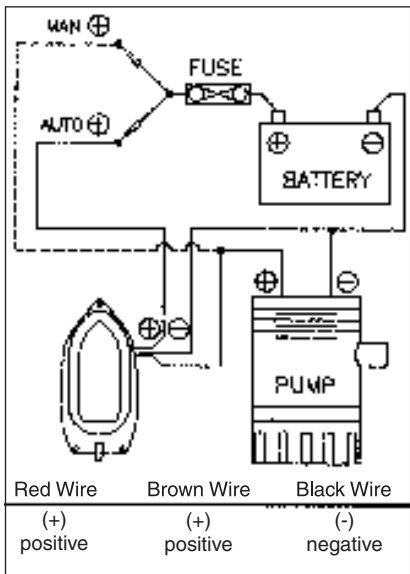

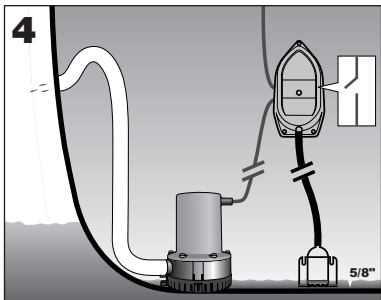
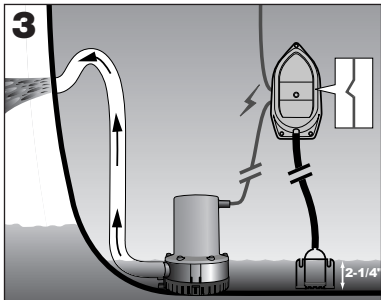

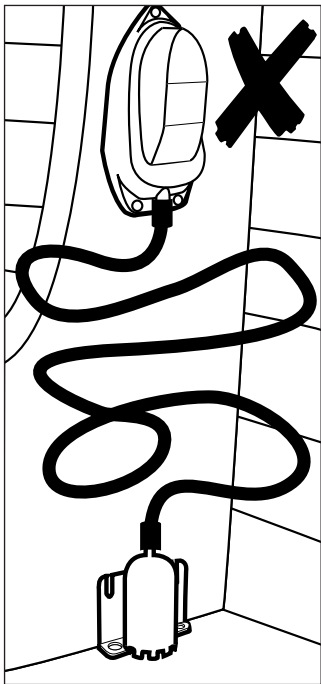

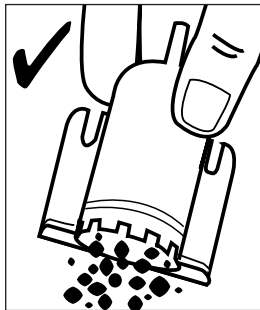
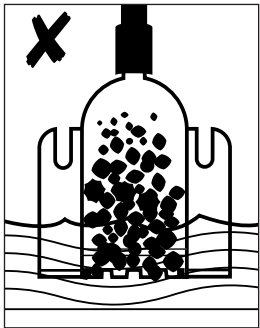

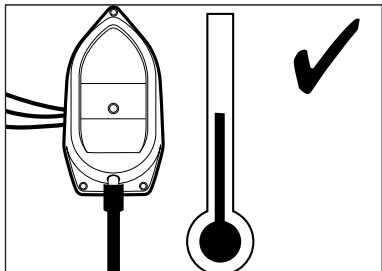
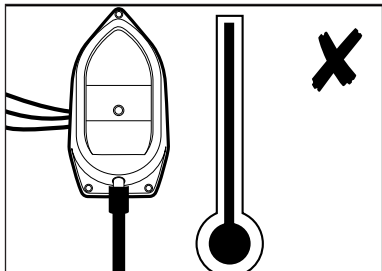

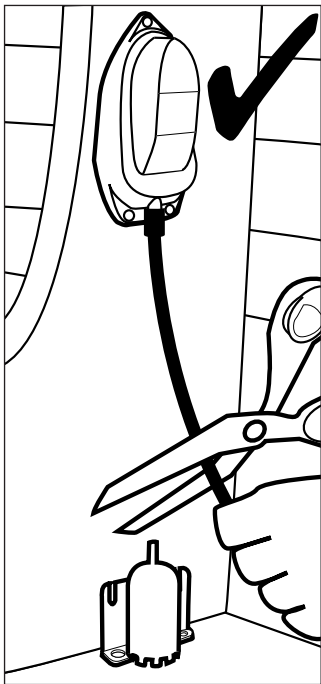

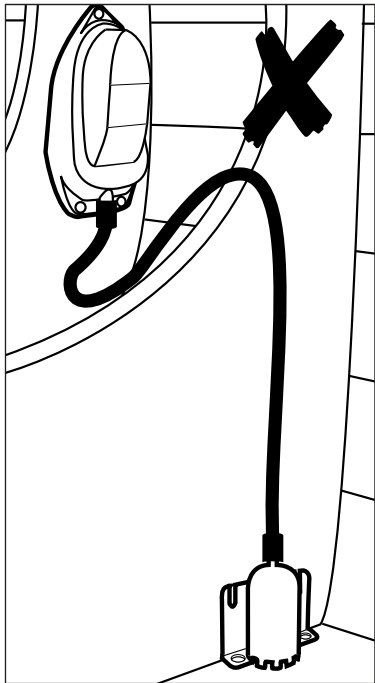

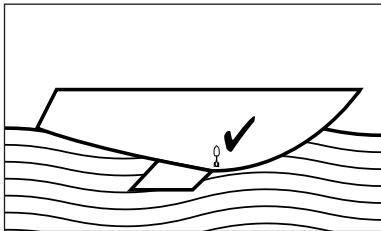
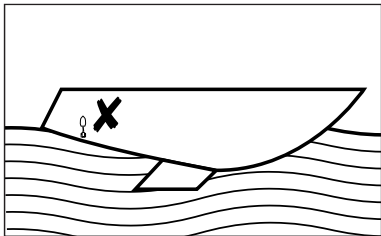

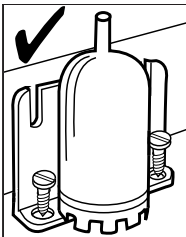
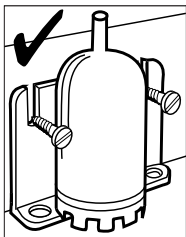
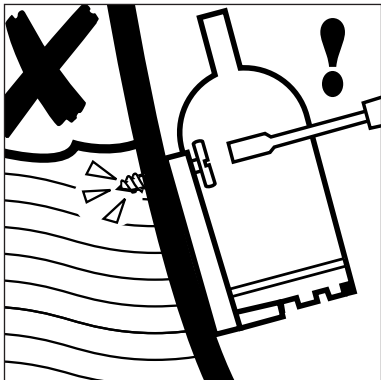

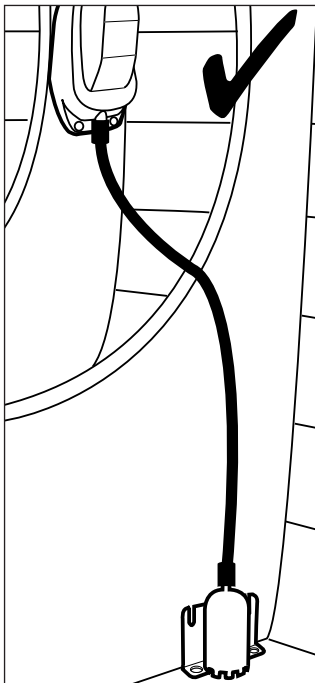

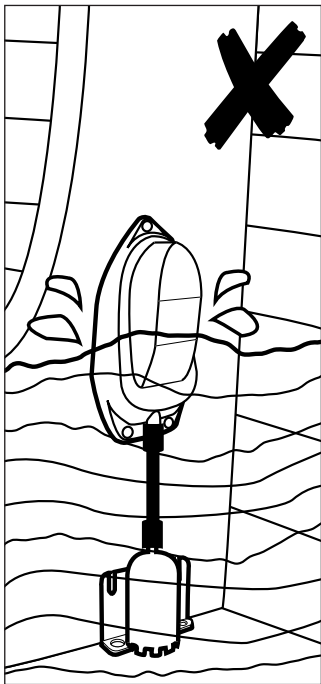

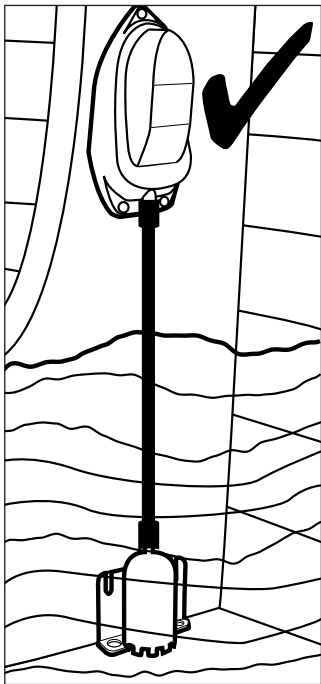



Visit us online at www.rule-industries.com

M-2026 Rev B 11/2012