

323/324/325 Clamp Meters Quick Reference Guide

⚠ Warning

To prevent possible electrical shock, fire, or personal injury, read the "323/324/325 Safety Sheet" before you use this Product.

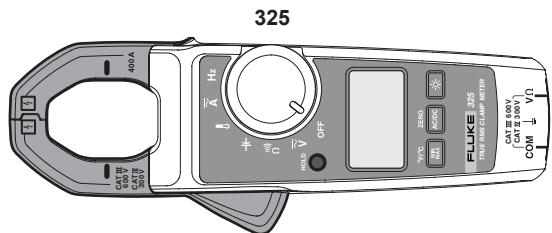

325

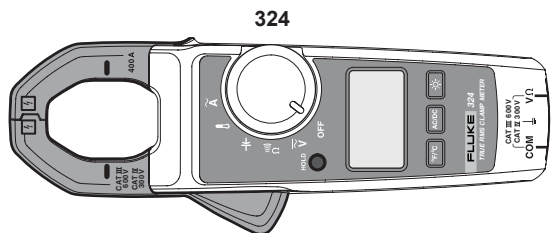

324

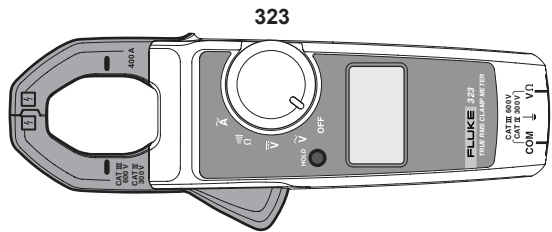

323

OFF

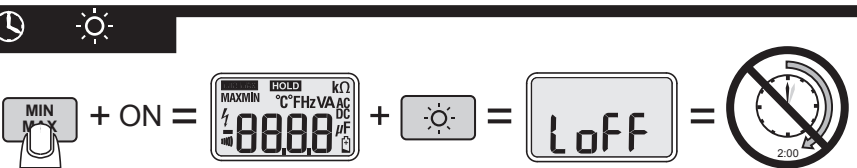
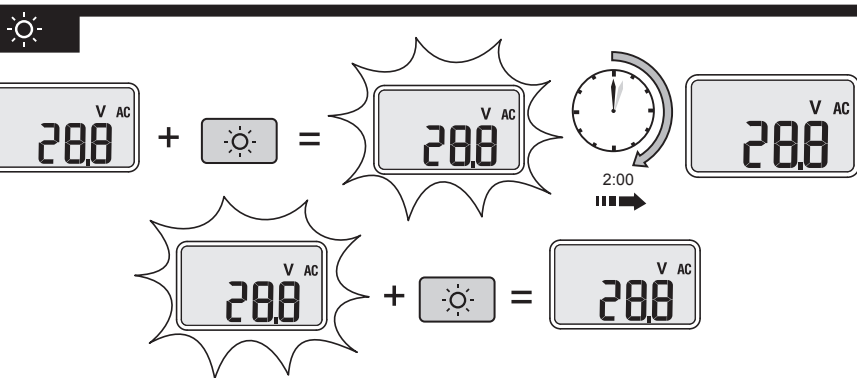
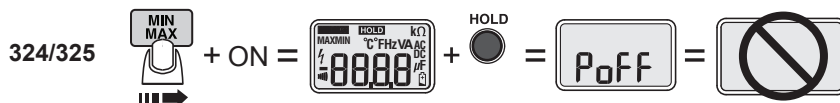
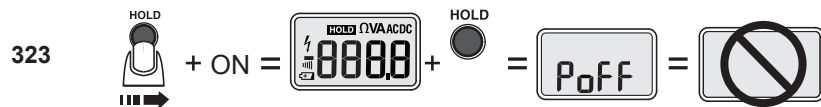
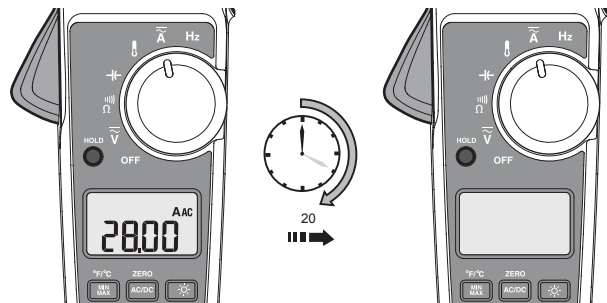

A

\tilde{A} 323, 324
 \bar{A} 325

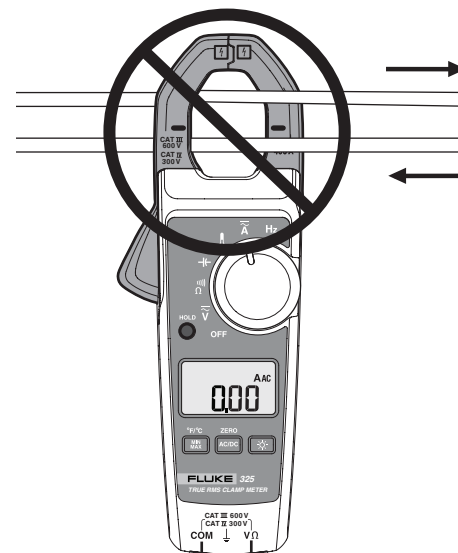
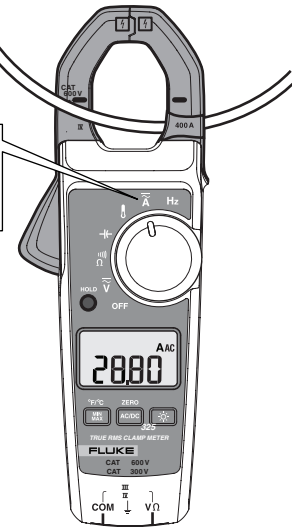

\tilde{V} \bar{V} Ω

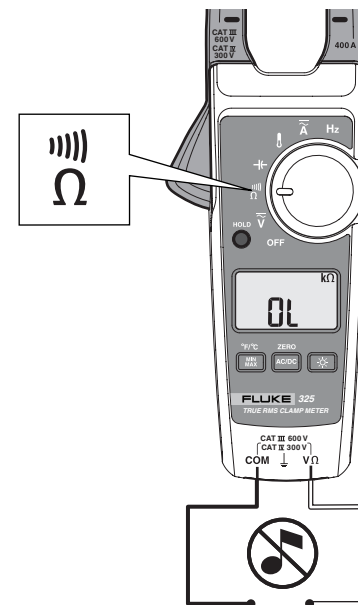
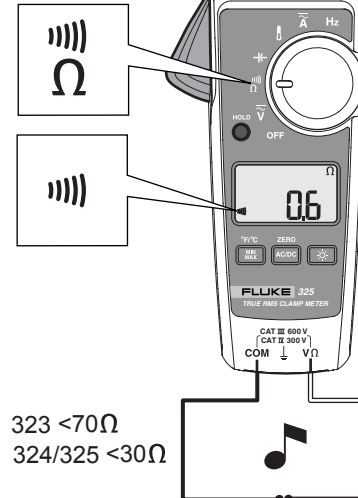
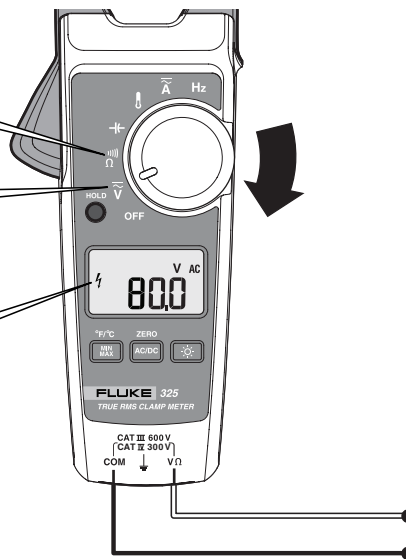
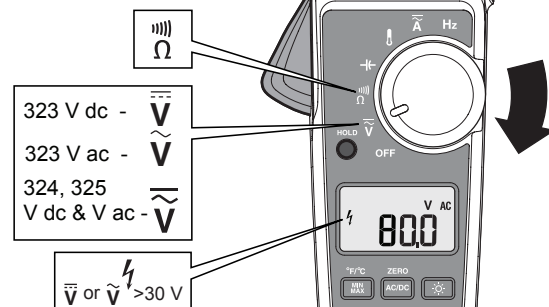

HOLD

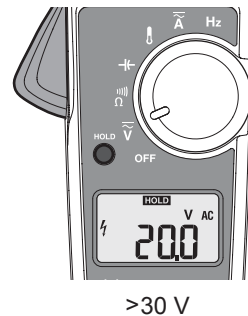
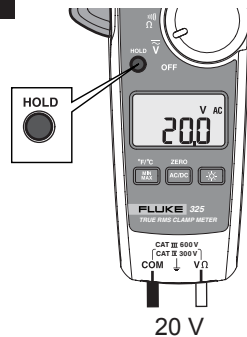

AC/DC & ZERO



324, 325

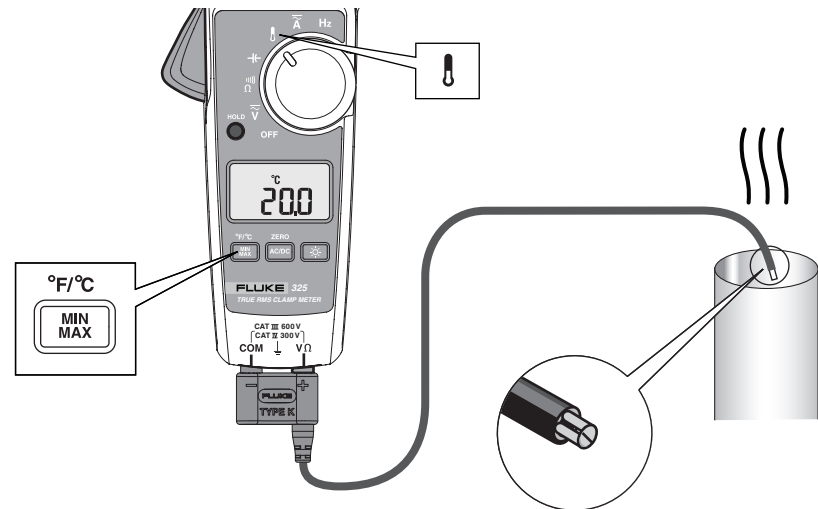

324, 325

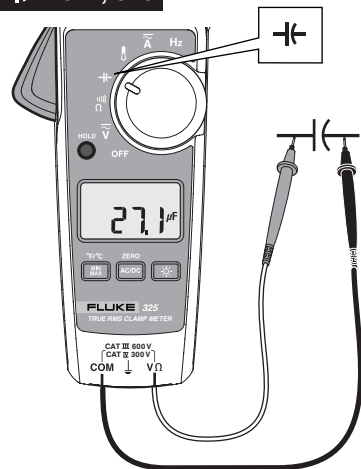

Hz 325

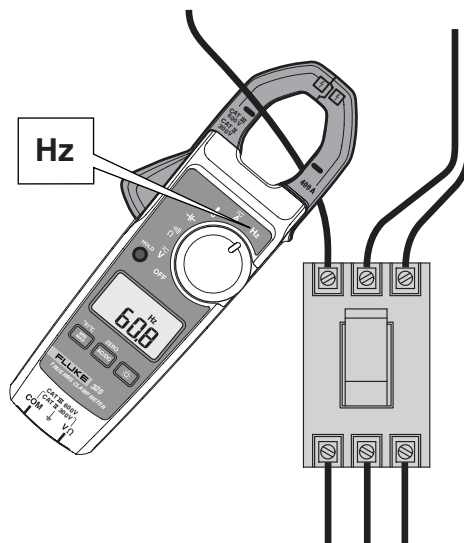

Specifications

Electrical Specifications

AC Current (Jaw)

Range	323	400.0 A
	324, 325	(40.00, 400.0) A
Resolution	323	0.1 A
	324, 325	(0.01, 0.1) A
Accuracy	323, 325	2.0 % ±5 digits (45 – 65 Hz)
		2.5 % ±5 digits (65 – 400 Hz)
	324	1.5 % ±5 digits (45 – 400 Hz)

Note: Add 2 % for position sensitivity.

DC Current with Jaw (325)

Range	(40.00, 400.0) A
Resolution	(0.01, 0.1) A
Accuracy	2.0 % ± 5 digits

AC Voltage

Range	600.0 V
Resolution	0.1 V
Accuracy (45 – 400 Hz)	1.5 % ± 5 digits

DC Voltage

Range	600.0 V
Resolution	0.1 V
Accuracy	1 % ±5 digits

Resistance

Range	323, 324	(400.0, 4000) Ω
	325	(400.0, 4000, 40000) Ω
Resolution	(0.1, 1, 10) Ω	
Accuracy	1 % ±5 digits	
Continuity Beeper			
	323	≤70 Ω
	324/325	≤30 Ω

Capacitance (324, 325)

Range	(100.0, 1000) μF
Resolution	(0.1, 1) μF
Accuracy	1 % ±4 digits

Frequency with Jaw (325)

Range	5.0 to 500.0 Hz
Resolution	0.1 Hz
Accuracy	0.5 % ±4 digits
Trigger Level	5 to 10 Hz, ≥10 A
	10 to 100 Hz, ≥5 A
	100 to 500 Hz, ≥10 A

Contact Temperature (324, 325)

Range	-10.0 °C to 400.0 °C
Resolution	0.1 °C
Accuracy	1 % ±8 digits

Note: Temperature uncertainty (accuracy) does not include error of the thermocouple probe.

Mechanical Specifications

Size (L x W x H)	(207 x 75 x 34) mm	
Weight			
	323	265 g
	324	208 g
	325	283 g

Environmental Specifications

Operating Temperature	-10 °C to +50 °C
Storage Temp	-30 °C to +60 °C
Operating Humidity	Non Condensing (≤10 °C)
		≤90 % RH (at 10 °C to 30 °C)
		≤75 % RH (at 30 °C to 40 °C)
		≤45 % RH (at 40 °C to 50 °C)
		(Without Condensation)

Operating Altitude	2000 meters
Storage Altitude	12,000 meters

EMI, EMC
Electromagnetic Compatibility Applies to use in Korea only. Class A Equipment (Industrial Broadcasting & Communication Equipment) [1]

[1] This product meets requirements for industrial (Class A) electromagnetic wave equipment and the seller or user should take notice of it. This equipment is intended for use in business environments and is not to be used in homes.

Temperature Coefficients Add 0.1 x specified accuracy for each degree C above 28 °C or below 18 °C

Over Voltage Category CAT IV 300 V, CAT III 600 V

Safety Compliance EN/IEC 61010-1, Pollution Degree 2
EN/IEC 61010-2-032
EN/IEC 61010-031:2002/A1:2008
CE

Agency Approvals Complies with CAN/CSA-C22.2 No. 61010-1, 2nd edition, including Amendment 1.,

IP Rating IP 30 Per IEC 60529:2001; Non-operating

Batteries 2 AAA, NEDA 24A, IEC LR03

+

