



# TEST REPORT

Reference No. : SZ2019100837-1E

Date : Nov. 08, 2019

Page No.: 1 of 60

Client : Ninghai Xidian Fangyu Electrical Appliance Factory

Address : No. 183 Qiaopeng Village, Xidian Town, Ninghai County, Zhejiang Province

The following merchandise was (were) submitted and identified by the client as:

Name of Product : Bicycle lights

Test Model : FY-319

Model May Cover : /

Main Material: /

Supplier: /

Buyer: /

Sample Received : Oct. 25, 2019

Nov. 06, 2019

Test Period : Oct. 25, 2019 - Nov. 08, 2019

As requested by the client, According to RoHS Directive 2011/65/EU(RoHS 2.0) and its subsequent amendments Directive (EU) 2015/863. Split the sample and determine the Pb, Cd, Hg, Cr (VI), PBBs, PBDEs, DEHP, BBP, DBP&DIBP content of the parts.

Test Specification and Conclusion:

RoHS Directive 2011/65/EU(RoHS 2.0) and its subsequent amendments  
Directive (EU) 2015/863

PASS

Prepared By :

**David Chen**  
Testing Engineer

Reviewed By :

**Dora Cheng**  
Reporter Supervisor

Issued By :



**Ada Wang**  
Lab Manager



SZ2019100837-1E

STQ Testing Services Co., Ltd.

Add.: Building 1, 15 Yinzhu Road, High-new district, Suzhou, China 215129

Tel.:+86/(0)512 67991866

Fax: +86/(0)512 87661802

Web:www.stq-cert.com

Technical service: [TS@stq-cert.com](mailto:TS@stq-cert.com)

Customer service: [CS@stq-cert.com](mailto:CS@stq-cert.com)

## TEST METHOD:

1. Sample prepared with reference to IEC 62321-2:2013 Determination of certain substances in electrotechnical products - Part 2: Disassembly, disjunction and mechanical sample preparation
2. Sample Screening testing with reference to IEC 62321-3-1:2013 Determination of certain substances in electrotechnical products - Part 3-1: Screening - Lead, mercury, cadmium, total chromium and total bromine using X-ray fluorescence spectrometry.
3. Wet Chemical Test Method
  - a. Determination of Lead ,Cadmium by ICP-OES with reference to IEC 62321-5:2013
  - b. Determination of Mercury by ICP-OES with reference to IEC 62321-4:2013+A1:2017
  - c. Determination of Hexavalent Chromium by Spot test or UV-Vis Method with reference to IEC 62321-7-1: 2015 or IEC 62321-7-2:2017
  - d. Determination of PBBs and PBDEs by GC-MS with reference to IEC 62321-6:2015
  - e. Determination of Phthalates by GC-MS with reference to IEC 62321-8:2017

\*\*\*\*\* To be continued \*\*\*\*\*

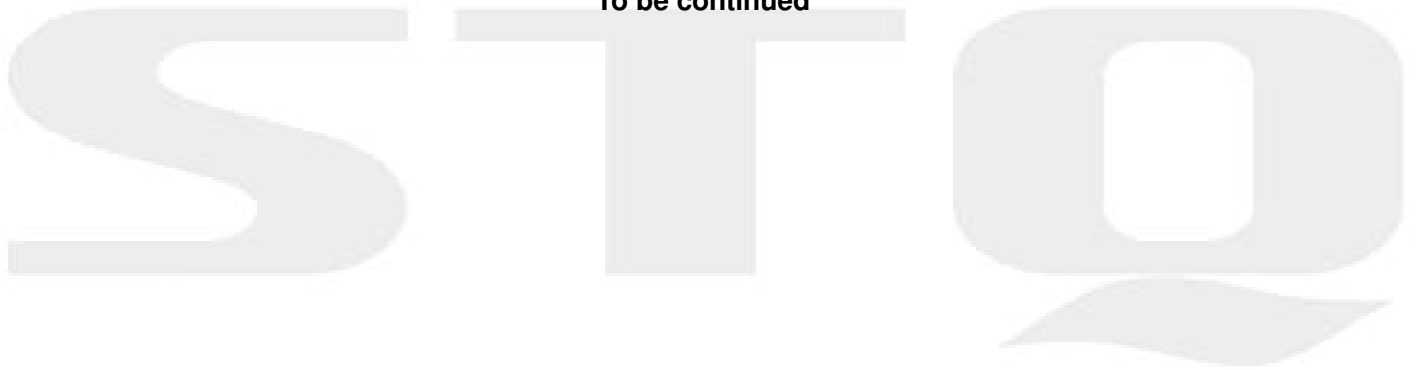

**TEST RESULTS:**

Part No.	Test Part of Photo & Description	Restricted Substances	Result of EDXRF (1)	Result of PHTH (2)	Result of Chemical Testing (3)(mg/kg)
1#		Pb	BL	---	---
		Cd	BL	---	---
		Hg	BL	---	---
		Cr(VI)	BL	---	---
		PBBs	BL	---	---
	Black plastic part (All)	PBDEs	---	---	
		DEHP	---	BL	---
		BBP	---	BL	---
		DBP	---	BL	---
		DIBP	---	BL	---
2#		Pb	BL	---	---
		Cd	BL	---	---
		Hg	BL	---	---
		Cr(VI)	IN	---	Negative
		PBBs	---	---	---
	Black plating metal screw (All)	PBDEs	---	---	---
		DEHP	---	---	---
		BBP	---	---	---
		DBP	---	---	---
		DIBP	---	---	---

Part No.	Test Part of Photo & Description	Restricted Substances	Result of EDXRF (1)	Result of PHTH (2)	Result of Chemical Testing (3)(mg/kg)
3#		Pb	BL	---	---
		Cd	BL	---	---
		Hg	BL	---	---
		Cr(VI)	BL	---	---
		PBBs	BL	---	---
	Black plastic part (All)	PBDEs	---	---	---
		DEHP	---	BL	---
		BBP	---	BL	---
		DBP	---	BL	---
4#		Pb	BL	---	---
		Cd	BL	---	---
		Hg	BL	---	---
		Cr(VI)	BL	---	---
		PBBs	BL	---	---
	Black plastic shell (All)	PBDEs	---	---	---
		DEHP	---	BL	---
		BBP	---	BL	---
		DBP	---	BL	---
		DIBP	---	BL	---

Part No.	Test Part of Photo & Description	Restricted Substances	Result of EDXRF (1)	Result of PHTH (2)	Result of Chemical Testing (3)(mg/kg)
5#		Pb	BL	---	---
		Cd	BL	---	---
		Hg	BL	---	---
		Cr(VI)	BL	---	---
		PBBs	BL	---	---
	Black rubber sheet (All)	PBDEs	---	---	---
		DEHP	---	BL	---
		BBP	---	BL	---
		DBP	---	BL	---
DIBP	---	BL	---		
6#		Pb	BL	---	---
		Cd	BL	---	---
		Hg	BL	---	---
		Cr(VI)	BL	---	---
		PBBs	BL	---	---
	White rubber button (All)	PBDEs	---	---	---
		DEHP	---	BL	---
		BBP	---	BL	---
		DBP	---	BL	---
DIBP	---	BL	---		

Part No.	Test Part of Photo & Description	Restricted Substances	Result of EDXRF (1)	Result of PHTH (2)	Result of Chemical Testing (3)(mg/kg)
7#		Pb	BL	---	---
		Cd	BL	---	---
		Hg	BL	---	---
		Cr(VI)	BL	---	---
	Black plastic part (Black)	PBBs	BL	---	---
		PBDEs	---	---	---
		DEHP	---	BL	---
		BBP	---	BL	---
8#		Pb	BL	---	---
		Cd	BL	---	---
		Hg	BL	---	---
		Cr(VI)	BL	---	---
	Black rubber sheath (Black)	PBBs	BL	---	---
		PBDEs	---	---	---
		DEHP	---	BL	---
		BBP	---	BL	---
		DBP	---	BL	---
		DIBP	---	BL	---

Part No.	Test Part of Photo & Description	Restricted Substances	Result of EDXRF (1)	Result of PHTH (2)	Result of Chemical Testing (3)(mg/kg)
9#		Pb	BL	---	---
		Cd	BL	---	---
		Hg	BL	---	---
		Cr(VI)	BL	---	---
		PBBs	BL	---	---
	Black rubber sheath (All)	PBDEs	---	---	---
		DEHP	---	BL	---
		BBP	---	BL	---
		DBP	---	BL	---
10#		Pb	BL	---	---
		Cd	BL	---	---
		Hg	BL	---	---
		Cr(VI)	BL	---	---
		PBBs	BL	---	---
	Transparent plastic lampshade (All)	PBDEs	---	---	---
		DEHP	---	BL	---
		BBP	---	BL	---
		DBP	---	BL	---
		DIBP	---	BL	---



Part No.	Test Part of Photo & Description	Restricted Substances	Result of EDXRF (1)	Result of PHTH (2)	Result of Chemical Testing (3)(mg/kg)
11#		Pb	BL	---	---
		Cd	BL	---	---
		Hg	BL	---	---
		Cr(VI)	BL	---	---
	PBBs	BL	---	---	
	PBDEs	---	---	---	
	DEHP	---	BL	---	
	BBP	---	BL	---	
12#		Pb	BL	---	---
		Cd	BL	---	---
		Hg	BL	---	---
		Cr(VI)	IN	---	Negative
	PBBs	---	---	---	
	PBDEs	---	---	---	
	DEHP	---	---	---	
	BBP	---	---	---	
DBP	---	---	---		
DIBP	---	---	---		

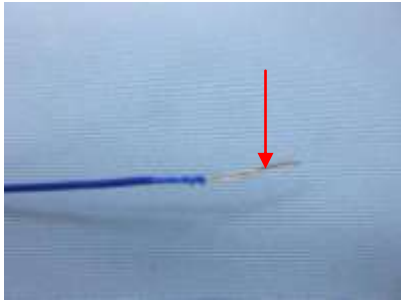
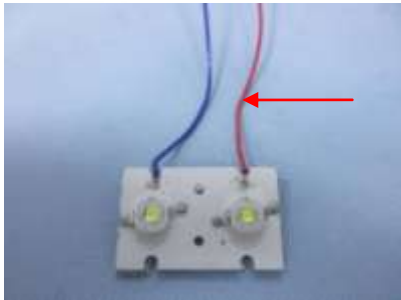

Part No.	Test Part of Photo & Description	Restricted Substances	Result of EDXRF (1)	Result of PHTH (2)	Result of Chemical Testing (3)(mg/kg)
13#		Pb	BL	---	---
		Cd	BL	---	---
		Hg	BL	---	---
		Cr(VI)	BL	---	---
	Black plastic frame	PBBs	BL	---	---
		PBDEs	---	---	---
		DEHP	---	BL	---
		BBP	---	BL	---
14#		Pb	BL	---	---
		Cd	BL	---	---
		Hg	BL	---	---
		Cr(VI)	BL	---	---
	Silvery reflect light piece	PBBs	BL	---	---
		PBDEs	---	---	---
		DEHP	---	BL	---
		BBP	---	BL	---
		DBP	---	BL	---
		DIBP	---	BL	---

Part No.	Test Part of Photo & Description	Restricted Substances	Result of EDXRF (1)	Result of PHTH (2)	Result of Chemical Testing (3)(mg/kg)
15#		Pb	BL	---	---
		Cd	BL	---	---
		Hg	BL	---	---
		Cr(VI)	BL	---	---
		PBBs	BL	---	---
	White paper sheet	PBDEs	---	---	---
		DEHP	---	IN	270
		BBP	---	BL	---
		DBP	---	BL	---
16#		Pb	BL	---	---
		Cd	BL	---	---
		Hg	BL	---	---
		Cr(VI)	BL	---	---
		PBBs	BL	---	---
	Blue wire jacket	PBDEs	---	---	---
		DEHP	---	IN	236
		BBP	---	BL	---
		DBP	---	BL	---
		DIBP	---	BL	---

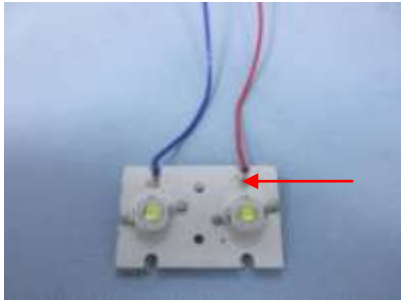
Part No.	Test Part of Photo & Description	Restricted Substances	Result of EDXRF (1)	Result of PHTH (2)	Result of Chemical Testing (3)(mg/kg)
17#		Pb	BL	---	---
		Cd	BL	---	---
		Hg	BL	---	---
		Cr(VI)	BL	---	---
	Coppery metal wire	PBBs	---	---	---
		PBDEs	---	---	---
		DEHP	---	---	---
		BBP	---	---	---
18#		Pb	BL	---	---
		Cd	BL	---	---
		Hg	BL	---	---
		Cr(VI)	BL	---	---
	Red wire jacket	PBBs	---	---	---
		PBDEs	---	---	---
		DEHP	---	IN	518
		BBP	---	BL	---
		DBP	---	BL	---
		DIBP	---	BL	---

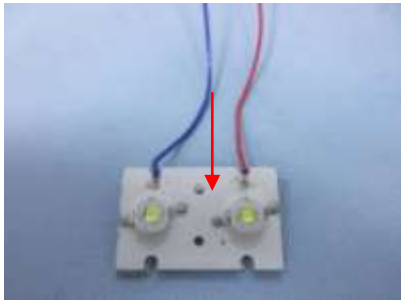
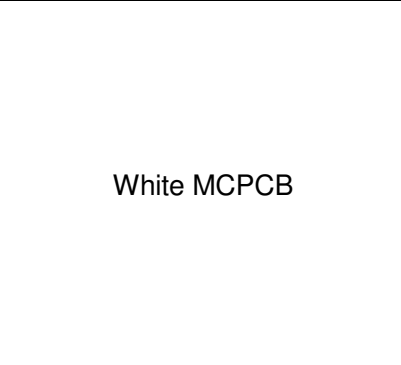
Part No.	Test Part of Photo & Description	Restricted Substances	Result of EDXRF (1)	Result of PHTH (2)	Result of Chemical Testing (3)(mg/kg)
19#		Pb	IN	---	193
		Cd	BL	---	---
		Hg	BL	---	---
	 <p>Silvery metal solder<sup>Δ</sup></p>	Cr(VI)	BL	---	---
		PBBs	---	---	---
		PBDEs	---	---	---
		DEHP	---	---	---
		BBP	---	---	---
		DBP	---	---	---
20#		Pb	BL	---	---
		Cd	BL	---	---
		Hg	BL	---	---
	 <p>White MCPCB</p>	Cr(VI)	BL	---	---
		PBBs	---	---	---
		PBDEs	BL	---	---
		DEHP	---	BL	---
		BBP	---	BL	---
		DBP	---	BL	---
DIBP	---	BL	---		

Part No.	Test Part of Photo & Description	Restricted Substances	Result of EDXRF (1)	Result of PHTH (2)	Result of Chemical Testing (3)(mg/kg)
21#		Pb	BL	---	---
		Cd	BL	---	---
		Hg	BL	---	---
		Cr(VI)	BL	---	---
	Transparent plastic lampshade	PBBs	BL	---	---
		PBDEs	---	---	---
		DEHP	---	BL	---
		BBP	---	BL	---
		DBP	---	BL	---
DIBP	---	BL	---		
22#		Pb	IN	---	93
		Cd	BL	---	---
		Hg	BL	---	---
		Cr(VI)	BL	---	---
	Silvery metal pin	PBBs	---	---	---
		PBDEs	---	---	---
		DEHP	---	---	---
		BBP	---	---	---
		DBP	---	---	---
DIBP	---	---	---		

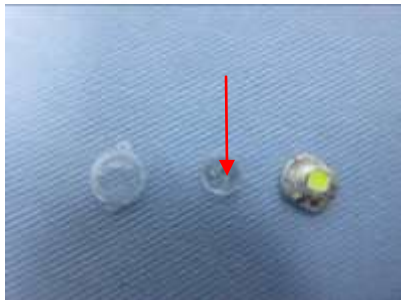
Part No.	Test Part of Photo & Description	Restricted Substances	Result of EDXRF (1)	Result of PHTH (2)	Result of Chemical Testing (3)(mg/kg)
23#		Pb	BL	---	---
		Cd	BL	---	---
		Hg	BL	---	---
	White plastic frame	Cr(VI)	BL	---	---
		PBBs	BL	---	---
		PBDEs	---	---	---
		DEHP	---	BL	---
		BBP	---	BL	---
		DBP	---	BL	---
24#		Pb	BL	---	---
		Cd	BL	---	---
		Hg	BL	---	---
	Transparent rubber part	Cr(VI)	BL	---	---
		PBBs	BL	---	---
		PBDEs	---	---	---
		DEHP	---	BL	---
		BBP	---	BL	---
		DBP	---	BL	---
		DIBP	---	BL	---

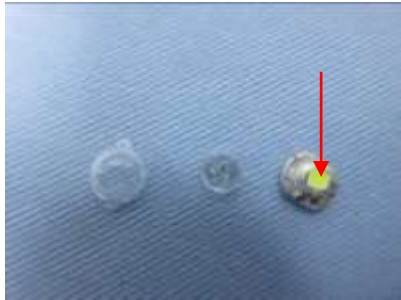
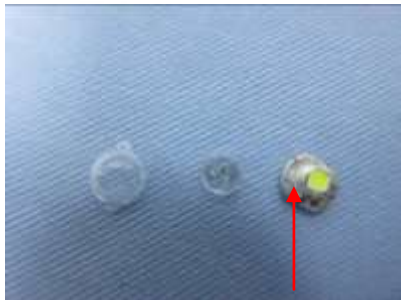
Part No.	Test Part of Photo & Description	Restricted Substances	Result of EDXRF (1)	Result of PHTH (2)	Result of Chemical Testing (3)(mg/kg)
25#		Pb	BL	---	---
		Cd	BL	---	---
		Hg	BL	---	---
	Yellow LED	Cr(VI)	BL	---	---
		PBBs	BL	---	---
		PBDEs	---	---	---
		DEHP	---	BL	---
		BBP	---	BL	---
		DBP	---	BL	---
26#		Pb	BL	---	---
		Cd	BL	---	---
		Hg	BL	---	---
	Silvery metal frame	Cr(VI)	BL	---	---
		PBBs	---	---	---
		PBDEs	---	---	---
		DEHP	---	---	---
		BBP	---	---	---
		DBP	---	---	---
DIBP	---	---	---		

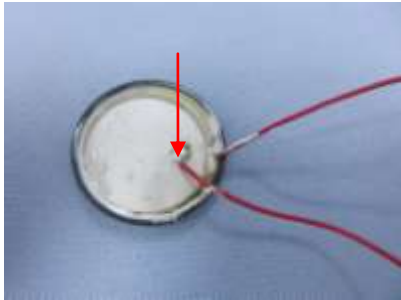
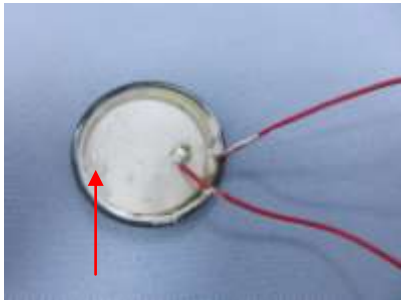
Part No.	Test Part of Photo & Description	Restricted Substances	Result of EDXRF (1)	Result of PHTH (2)	Result of Chemical Testing (3)(mg/kg)
27#		Pb	IN	---	193
		Cd	BL	---	---
		Hg	BL	---	---
	Silvery metal solder <sup>△</sup>	Cr(VI)	BL	---	---
		PBBs	---	---	---
		PBDEs	---	---	---
		DEHP	---	---	---
		BBP	---	---	---
		DBP	---	---	---
28#		Pb	BL	---	---
		Cd	BL	---	---
		Hg	BL	---	---
	White solid glue	Cr(VI)	BL	---	---
		PBBs	---	---	---
		PBDEs	BL	---	---
		DEHP	---	IN	608
		BBP	---	BL	---
		DBP	---	BL	---
		DIBP	---	BL	---

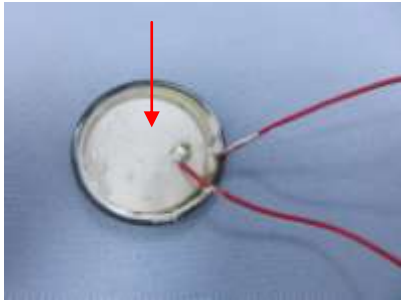
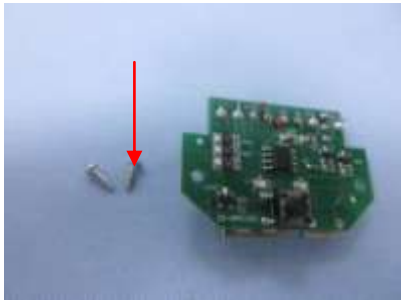

Part No.	Test Part of Photo & Description	Restricted Substances	Result of EDXRF (1)	Result of PHTH (2)	Result of Chemical Testing (3)(mg/kg)
29#		Pb	IN	---	401287 <sup>①</sup>
		Cd	BL	---	---
		Hg	BL	---	---
		Cr(VI)	BL	---	---
		PBBs	BL	---	---
	White ceramic sheet	PBDEs	---	---	---
		DEHP	---	BL	---
		BBP	---	BL	---
		DBP	---	BL	---
DIBP	---	BL	---		
30#		Pb	BL	---	---
		Cd	BL	---	---
		Hg	BL	---	---
		Cr(VI)	IN	---	Negative
		PBBs	---	---	---
	Silvery metal screw	PBDEs	---	---	---
		DEHP	---	---	---
		BBP	---	---	---
		DBP	---	---	---
DIBP	---	---	---		

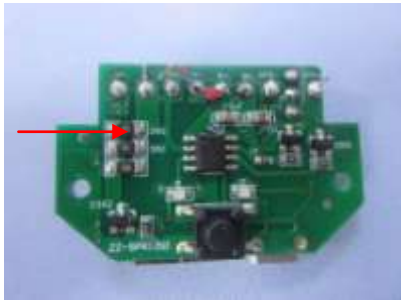
Part No.	Test Part of Photo & Description	Restricted Substances	Result of EDXRF (1)	Result of PHTH (2)	Result of Chemical Testing (3)(mg/kg)	
31#		Pb	IN	---	193	
		Cd	BL	---	---	
		Hg	BL	---	---	
		Cr(VI)	BL	---	---	
			PBBs	---	---	---
			PBDEs	---	---	---
			DEHP	---	---	---
		Silvery metal solder <sup>△</sup>	BBP	---	---	---
			DBP	---	---	---
		DIBP	---	---	---	
32#		Pb	IN	---	62649 <sup>①</sup>	
		Cd	BL	---	---	
		Hg	BL	---	---	
		Cr(VI)	IN	---	N.D.	
			PBBs	---	---	---
			PBDEs	---	---	---
			DEHP	---	BL	---
		Black chip resistor	BBP	---	BL	---
			DBP	---	BL	---
		DIBP	---	BL	---	

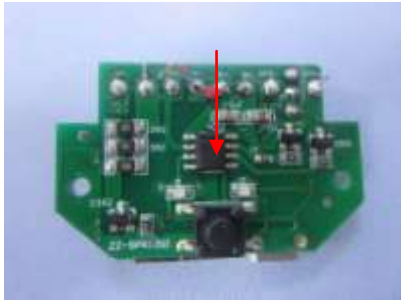
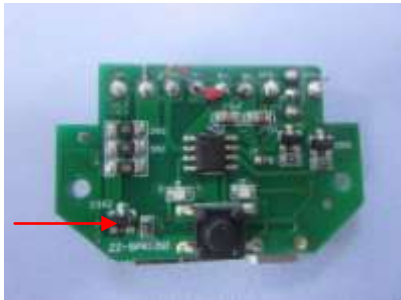
Part No.	Test Part of Photo & Description	Restricted Substances	Result of EDXRF (1)	Result of PHTH (2)	Result of Chemical Testing (3)(mg/kg)	
33#		Pb	IN	---	18205 <sup>①</sup>	
		Cd	BL	---	---	
		Hg	BL	---	---	
	Black IC	Cr(VI)	IN	---	---	N.D.
		PBBs	BL	---	---	---
		PBDEs	---	---	---	---
		DEHP	---	BL	---	---
		BBP	---	BL	---	---
		DBP	---	BL	---	---
34#		Pb	BL	---	---	
		Cd	BL	---	---	
		Hg	BL	---	---	
	Black triode	Cr(VI)	IN	---	---	N.D.
		PBBs	IN	---	---	N.D.
		PBDEs	---	---	---	N.D.
		DEHP	---	BL	---	---
		BBP	---	BL	---	---
		DBP	---	BL	---	---
DIBP	---	BL	---	---		

Part No.	Test Part of Photo & Description	Restricted Substances	Result of EDXRF (1)	Result of PHTH (2)	Result of Chemical Testing (3)(mg/kg)
35#		Pb	IN	---	35358 <sup>①</sup>
		Cd	BL	---	---
		Hg	BL	---	---
		Cr(VI)	BL	---	---
		PBBs	IN	---	N.D.
	Black chip resistor	PBDEs	---	---	N.D.
		DEHP	---	BL	---
		BBP	---	BL	---
		DBP	---	BL	---
	DIBP	---	BL	---	
36#		Pb	BL	---	---
		Cd	BL	---	---
		Hg	BL	---	---
		Cr(VI)	BL	---	---
		PBBs	BL	---	---
	White LED	PBDEs	---	---	---
		DEHP	---	BL	---
		BBP	---	BL	---
		DBP	---	BL	---
	DIBP	---	BL	---	

Part No.	Test Part of Photo & Description	Restricted Substances	Result of EDXRF (1)	Result of PHTH (2)	Result of Chemical Testing (3)(mg/kg)
37#		Pb	BL	---	---
		Cd	BL	---	---
		Hg	BL	---	---
		Cr(VI)	BL	---	---
		PBBs	BL	---	---
	Black plastic button	PBDEs	---	---	---
		DEHP	---	BL	---
		BBP	---	BL	---
		DBP	---	BL	---
38#		Pb	BL	---	---
		Cd	BL	---	---
		Hg	BL	---	---
		Cr(VI)	BL	---	---
		PBBs	---	---	---
	Silvery metal frame	PBDEs	---	---	---
		DEHP	---	---	---
		BBP	---	---	---
		DBP	---	---	---
		DIBP	---	---	---

Part No.	Test Part of Photo & Description	Restricted Substances	Result of EDXRF (1)	Result of PHTH (2)	Result of Chemical Testing (3)(mg/kg)	
39#		Pb	BL	---	---	
		Cd	BL	---	---	
		Hg	BL	---	---	
			Cr(VI)	IN	---	Negative
			PBBs	---	---	---
			PBDEs	---	---	---
			DEHP	---	---	---
		Silvery metal contact sheet	BBP	---	---	---
			DBP	---	---	---
		DIBP	---	---	---	
40#		Pb	BL	---	---	
		Cd	BL	---	---	
		Hg	BL	---	---	
			Cr(VI)	BL	---	---
			PBBs	---	---	---
			PBDEs	BL	---	---
			DEHP	---	BL	---
		Black plastic frame	BBP	---	BL	---
			DBP	---	BL	---
		DIBP	---	BL	---	

Part No.	Test Part of Photo & Description	Restricted Substances	Result of EDXRF (1)	Result of PHTH (2)	Result of Chemical Testing (3)(mg/kg)
41#		Pb	BL	---	---
		Cd	BL	---	---
		Hg	BL	---	---
	 <p>Silvery metal pin</p>	Cr(VI)	BL	---	---
		PBBs	---	---	---
		PBDEs	---	---	---
		DEHP	---	---	---
		BBP	---	---	---
		DBP	---	---	---
42#		Pb	BL	---	---
		Cd	BL	---	---
		Hg	BL	---	---
	 <p>Black heat shrinkable tube</p>	Cr(VI)	BL	---	---
		PBBs	---	---	N.D.
		PBDEs	IN	---	N.D.
		DEHP	---	IN	95
		BBP	---	BL	---
		DBP	---	BL	---
DIBP	---	BL	---		

Part No.	Test Part of Photo & Description	Restricted Substances	Result of EDXRF (1)	Result of PHTH (2)	Result of Chemical Testing (3)(mg/kg)
43#		Pb	BL	---	---
		Cd	BL	---	---
		Hg	BL	---	---
		Cr(VI)	BL	---	---
	PBBs	---	---	---	
	PBDEs	---	---	---	
	DEHP	---	---	---	
	BBP	---	---	---	
	DBP	---	---	---	
DIBP	---	---	---		
44#		Pb	BL	---	---
		Cd	BL	---	---
		Hg	BL	---	---
		Cr(VI)	BL	---	---
	PBBs	---	---	---	
	PBDEs	---	---	---	
	DEHP	---	BL	---	
	BBP	---	BL	---	
	DBP	---	BL	---	
DIBP	---	BL	---		
	Black plastic part				



Part No.	Test Part of Photo & Description	Restricted Substances	Result of EDXRF (1)	Result of PHTH (2)	Result of Chemical Testing (3)(mg/kg)	
45#		Pb	BL	---	---	
		Cd	BL	---	---	
		Hg	BL	---	---	
	Black magnet frame	Cr(VI)	IN	---	---	Negative
		PBBs	---	---	---	
		PBDEs	---	---	---	
		DEHP	---	---	---	
		BBP	---	---	---	
		DBP	---	---	---	
46#		Pb	BL	---	---	
		Cd	BL	---	---	
		Hg	BL	---	---	
	Coppery metal coil	Cr(VI)	BL	---	---	---
		PBBs	---	---	---	
		PBDEs	---	---	---	
		DEHP	---	---	---	
		BBP	---	---	---	
		DBP	---	---	---	
DIBP	---	---	---			

Part No.	Test Part of Photo & Description	Restricted Substances	Result of EDXRF (1)	Result of PHTH (2)	Result of Chemical Testing (3)(mg/kg)
47#		Pb	BL	---	---
		Cd	BL	---	---
		Hg	BL	---	---
		Cr(VI)	IN	---	Negative
	Black magnet frame	PBBs	---	---	---
		PBDEs	---	---	---
		DEHP	---	---	---
		BBP	---	---	---
48#		Pb	BL	---	---
		Cd	BL	---	---
		Hg	BL	---	---
		Cr(VI)	BL	---	---
	Coppery metal coil	PBBs	---	---	---
		PBDEs	---	---	---
		DEHP	---	---	---
		BBP	---	---	---
		DBP	---	---	---
		DIBP	---	---	---

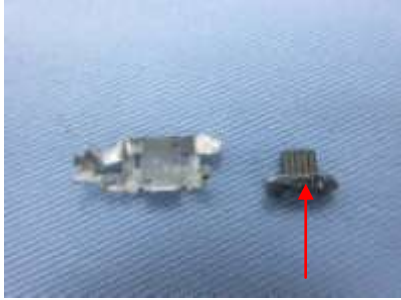
Part No.	Test Part of Photo & Description	Restricted Substances	Result of EDXRF (1)	Result of PHTH (2)	Result of Chemical Testing (3)(mg/kg)
49#		Pb	BL	---	---
		Cd	BL	---	---
		Hg	BL	---	---
		Cr(VI)	BL	---	---
	 <p>Silvery metal shell</p>	PBBs	---	---	---
		PBDEs	---	---	---
		DEHP	---	---	---
		BBP	---	---	---
50#		Pb	BL	---	---
		Cd	BL	---	---
		Hg	BL	---	---
		Cr(VI)	BL	---	---
	 <p>Black plastic frame</p>	PBBs	BL	---	---
		PBDEs	---	---	---
		DEHP	---	BL	---
		BBP	---	BL	---
		DBP	---	BL	---
		DIBP	---	BL	---

Part No.	Test Part of Photo & Description	Restricted Substances	Result of EDXRF (1)	Result of PHTH (2)	Result of Chemical Testing (3)(mg/kg)
51#		Pb	IN	---	877
		Cd	BL	---	---
		Hg	BL	---	---
	Golden metal pin	Cr(VI)	BL	---	---
		PBBs	---	---	---
		PBDEs	---	---	---
		DEHP	---	---	---
		BBP	---	---	---
		DBP	---	---	---
52#		Pb	BL	---	---
		Cd	BL	---	---
		Hg	BL	---	---
	Silvery metal shell	Cr(VI)	BL	---	---
		PBBs	---	---	---
		PBDEs	---	---	---
		DEHP	---	---	---
		BBP	---	---	---
		DBP	---	---	---
DIBP	---	---	---		



Part No.	Test Part of Photo & Description	Restricted Substances	Result of EDXRF (1)	Result of PHTH (2)	Result of Chemical Testing (3)(mg/kg)
53#		Pb	BL	---	---
		Cd	BL	---	---
		Hg	BL	---	---
		Cr(VI)	BL	---	---
		PBBs	BL	---	---
	White plastic frame	PBDEs	---	---	---
		DEHP	---	BL	---
		BBP	---	BL	---
		DBP	---	BL	---
DIBP	---	BL	---		
54#		Pb	IN	---	20182 <sup>®</sup>
		Cd	BL	---	---
		Hg	BL	---	---
		Cr(VI)	BL	---	---
		PBBs	---	---	---
	Silvery metal pin	PBDEs	---	---	---
		DEHP	---	---	---
		BBP	---	---	---
		DBP	---	---	---
DIBP	---	---	---		

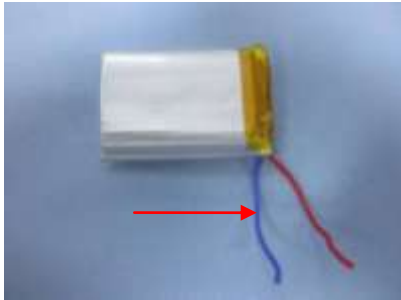
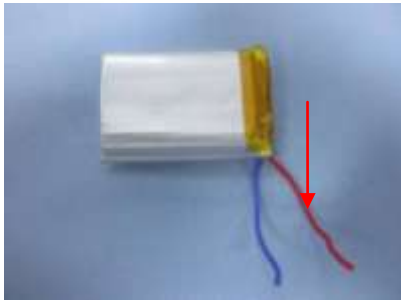

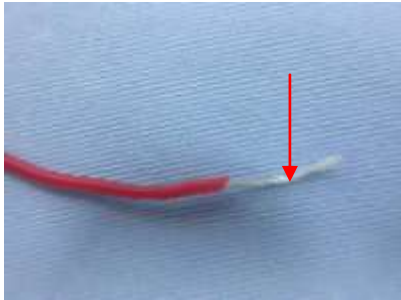
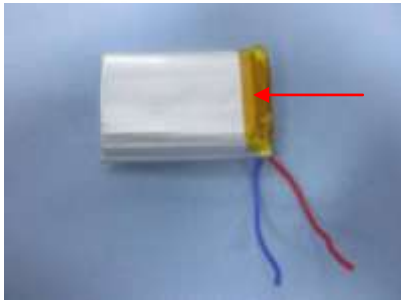
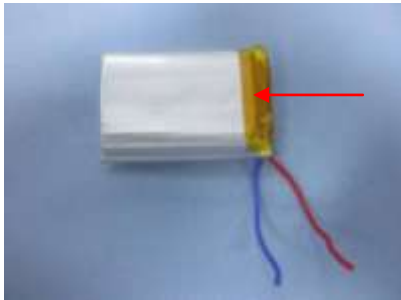
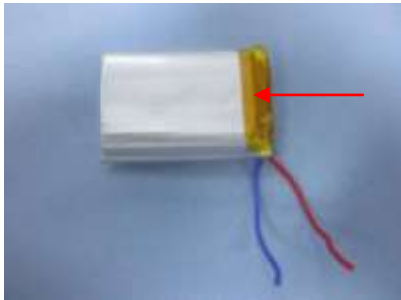
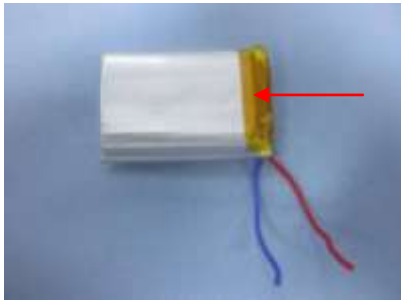
Part No.	Test Part of Photo & Description	Restricted Substances	Result of EDXRF (1)	Result of PHTH (2)	Result of Chemical Testing (3)(mg/kg)
55#		Pb	IN	---	193
		Cd	BL	---	---
		Hg	BL	---	---
	 <p>Silvery metal solder<sup>Δ</sup></p>	Cr(VI)	BL	---	---
		PBBs	---	---	---
		PBDEs	---	---	---
		DEHP	---	---	---
		BBP	---	---	---
		DBP	---	---	---
56#		Pb	BL	---	---
		Cd	BL	---	---
		Hg	BL	---	---
	 <p>Green PCB</p>	Cr(VI)	BL	---	---
		PBBs	---	---	---
		PBDEs	BL	---	---
		DEHP	---	BL	---
		BBP	---	BL	---
		DBP	---	BL	---
DIBP	---	BL	---		

Part No.	Test Part of Photo & Description	Restricted Substances	Result of EDXRF (1)	Result of PHTH (2)	Result of Chemical Testing (3)(mg/kg)
57#		Pb	BL	---	---
		Cd	BL	---	---
		Hg	BL	---	---
		Cr(VI)	BL	---	---
		PBBs	BL	---	---
	Blue wire jacket	PBDEs	---	---	---
		DEHP	---	BL	---
		BBP	---	BL	---
		DBP	---	BL	---
58#		Pb	BL	---	---
		Cd	BL	---	---
		Hg	BL	---	---
		Cr(VI)	BL	---	---
		PBBs	BL	---	---
	Red wire jacket	PBDEs	---	---	---
		DEHP	---	IN	164
		BBP	---	BL	---
		DBP	---	BL	---
		DIBP	---	BL	---

Part No.	Test Part of Photo & Description	Restricted Substances	Result of EDXRF (1)	Result of PHTH (2)	Result of Chemical Testing (3)(mg/kg)
59#		Pb	BL	---	---
		Cd	BL	---	---
		Hg	BL	---	---
		Cr(VI)	BL	---	---
		PBBs	---	---	---
		PBDEs	---	---	---
		DEHP	---	---	---
		BBP	---	---	---
		DBP	---	---	---
60#		DIBP	---	---	---
		Pb	BL	---	---
		Cd	BL	---	---
		Hg	BL	---	---
		Cr(VI)	BL	---	---
		PBBs	---	---	---
		PBDEs	---	---	---
		DEHP	---	IN	114
		BBP	---	BL	---
	DBP	---	BL	---	
	DIBP	---	BL	---	



Part No.	Test Part of Photo & Description	Restricted Substances	Result of EDXRF (1)	Result of PHTH (2)	Result of Chemical Testing (3)(mg/kg)
61#		Pb	IN	---	193
		Cd	BL	---	---
		Hg	BL	---	---
		Cr(VI)	BL	---	---
	Silvery metal solder <sup>Δ</sup>	PBBs	---	---	---
		PBDEs	---	---	---
		DEHP	---	---	---
		BBP	---	---	---
62#		Pb	BL	---	---
		Cd	BL	---	---
		Hg	BL	---	---
		Cr(VI)	BL	---	---
	Silvery metal contact sheet	PBBs	---	---	---
		PBDEs	---	---	---
		DEHP	---	---	---
		BBP	---	---	---
		DBP	---	---	---
		DIBP	---	---	---



Part No.	Test Part of Photo & Description	Restricted Substances	Result of EDXRF (1)	Result of PHTH (2)	Result of Chemical Testing (3)(mg/kg)
63#		Pb	BL	---	---
		Cd	BL	---	---
		Hg	BL	---	---
		Cr(VI)	BL	---	---
		PBBs	BL	---	---
	Black rubber belt	PBDEs	---	---	---
		DEHP	---	BL	---
		BBP	---	BL	---
		DBP	---	BL	---
64#		Pb	BL	---	---
		Cd	BL	---	---
		Hg	BL	---	---
		Cr(VI)	BL	---	---
		PBBs	BL	---	---
	Black plastic shell	PBDEs	---	---	---
		DEHP	---	BL	---
		BBP	---	BL	---
		DBP	---	BL	---
		DIBP	---	BL	---

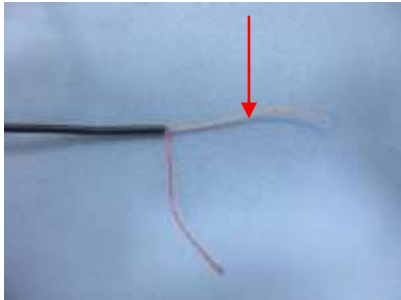
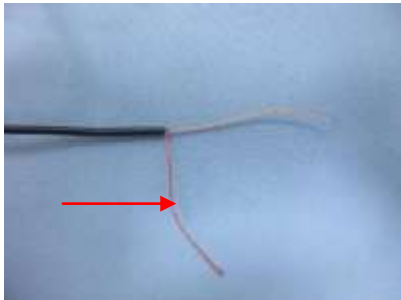

Part No.	Test Part of Photo & Description	Restricted Substances	Result of EDXRF (1)	Result of PHTH (2)	Result of Chemical Testing (3)(mg/kg)
65#		Pb	IN	---	193
		Cd	BL	---	---
		Hg	BL	---	---
		Cr(VI)	BL	---	---
	Silvery metal solder <sup>Δ</sup>	PBBs	---	---	---
		PBDEs	---	---	---
		DEHP	---	---	---
		BBP	---	---	---
		DBP	---	---	---
66#		Pb	BL	---	---
		Cd	BL	---	---
		Hg	BL	---	---
		Cr(VI)	BL	---	---
	Black insulation jacket	PBBs	BL	---	---
		PBDEs	---	---	---
		DEHP	---	BL	---
		BBP	---	BL	---
		DBP	---	BL	---
DIBP	---	BL	---		

Part No.	Test Part of Photo & Description	Restricted Substances	Result of EDXRF (1)	Result of PHTH (2)	Result of Chemical Testing (3)(mg/kg)
67#		Pb	BL	---	---
		Cd	BL	---	---
		Hg	BL	---	---
		Cr(VI)	BL	---	---
		PBBs	BL	---	---
	Transparent wire jacket	PBDEs	---	---	---
		DEHP	---	BL	---
		BBP	---	BL	---
		DBP	---	BL	---
DIBP	---	BL	---		
68#		Pb	BL	---	---
		Cd	BL	---	---
		Hg	BL	---	---
		Cr(VI)	BL	---	---
		PBBs	---	---	---
	Red varnished wire	PBDEs	---	---	---
		DEHP	---	---	---
		BBP	---	---	---
		DBP	---	---	---
DIBP	---	---	---		

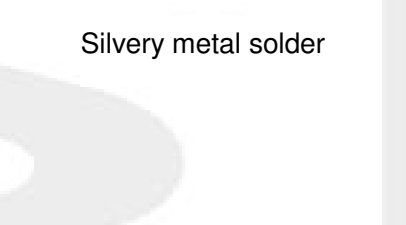
Part No.	Test Part of Photo & Description	Restricted Substances	Result of EDXRF (1)	Result of PHTH (2)	Result of Chemical Testing (3)(mg/kg)
69#		Pb	BL	---	---
		Cd	BL	---	---
		Hg	BL	---	---
	White fabric line	Cr(VI)	BL	---	---
		PBBs	BL	---	---
		PBDEs	---	---	---
		DEHP	---	BL	---
		BBP	---	BL	---
		DBP	---	BL	---
70#		Pb	BL	---	---
		Cd	BL	---	---
		Hg	BL	---	---
	Red plastic part (Red)	Cr(VI)	BL	---	---
		PBBs	BL	---	---
		PBDEs	---	---	---
		DEHP	---	BL	---
		BBP	---	BL	---
		DBP	---	BL	---
		DIBP	---	BL	---

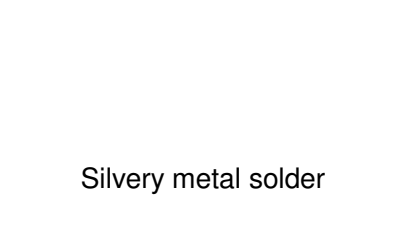
Part No.	Test Part of Photo & Description	Restricted Substances	Result of EDXRF (1)	Result of PHTH (2)	Result of Chemical Testing (3)(mg/kg)
71#		Pb	BL	---	---
		Cd	BL	---	---
		Hg	BL	---	---
		Cr(VI)	BL	---	---
	Red rubber sheath (Red)	PBBs	BL	---	---
		PBDEs	---	---	---
		DEHP	---	BL	---
		BBP	---	BL	---
		DBP	---	BL	---
	DIBP	---	BL	---	
19#-R		Pb	IN	---	193
		Cd	BL	---	---
		Hg	BL	---	---
		Cr(VI)	BL	---	---
	Silvery metal solder	PBBs	---	---	---
		PBDEs	---	---	---
		DEHP	---	---	---
		BBP	---	---	---
		DBP	---	---	---
	DIBP	---	---	---	

Part No.	Test Part of Photo & Description	Restricted Substances	Result of EDXRF (1)	Result of PHTH (2)	Result of Chemical Testing (3)(mg/kg)	
27#-R		Pb	IN	---	193	
		Cd	BL	---	---	
		Hg	BL	---	---	
		Cr(VI)	BL	---	---	
			PBBs	---	---	---
	PBDEs		---	---	---	
	DEHP		---	---	---	
	BBP		---	---	---	
	DBP		---	---	---	
		DIBP	---	---	---	
31#-R		Pb	IN	---	193	
		Cd	BL	---	---	
		Hg	BL	---	---	
		Cr(VI)	BL	---	---	
			PBBs	---	---	---
	PBDEs		---	---	---	
	DEHP		---	---	---	
	BBP		---	---	---	
	DBP		---	---	---	
		DIBP	---	---	---	

Part No.	Test Part of Photo & Description	Restricted Substances	Result of EDXRF (1)	Result of PHTH (2)	Result of Chemical Testing (3)(mg/kg)	
55#-R		Pb	IN	---	193	
		Cd	BL	---	---	
		Hg	BL	---	---	
		Cr(VI)	BL	---	---	
			PBBs	---	---	---
			PBDEs	---	---	---
			DEHP	---	---	---
			BBP	---	---	---
			DBP	---	---	---
		DIBP	---	---	---	
61#-R		Pb	IN	---	193	
		Cd	BL	---	---	
		Hg	BL	---	---	
		Cr(VI)	BL	---	---	
			PBBs	---	---	---
			PBDEs	---	---	---
			DEHP	---	---	---
			BBP	---	---	---
			DBP	---	---	---
		DIBP	---	---	---	



Part No.	Test Part of Photo & Description	Restricted Substances	Result of EDXRF (1)	Result of PHTH (2)	Result of Chemical Testing (3)(mg/kg)	
65#-R		Pb	IN	---	193	
		Cd	BL	---	---	
		Hg	BL	---	---	
		Cr(VI)	BL	---	---	
			PBBs	---	---	---
			PBDEs	---	---	---
			DEHP	---	---	---
		Silvery metal solder	BBP	---	---	---
			DBP	---	---	---
		DIBP	---	---	---	

\*\*\*\*\* To be continued \*\*\*\*\*

**Remark:**

- (1) (a) It is the result on total Br while test item on restricted substances is PBBs/PBDEs. It is the result on total Cr while test item on restricted substances is Cr<sup>6+</sup>.  
 (b) Results are obtained by EDXRF for primary screening, and further chemical testing by ICP-OES (for Cd, Pb, Hg), UV-Vis (for Cr<sup>6+</sup>) and GC/MS (for PBBs, PBDEs) is recommended to be performed, if the concentration exceeds the below warning value according to IEC62321-3-1:2013 (unit: mg/kg)

Element	Polymer	Metal	Composite Materials
Cd	BL≤(70-3σ)<X<(130+3σ) ≤OL	BL≤(70-3σ)<X<(130+3σ) ≤OL	LOD<X<(150+3σ) ≤OL
Pb	BL≤(700-3σ)<X<(1300+3σ) ≤OL	BL≤(700-3σ)<X<(1300+3σ) ≤OL	BL≤(500-3σ)<X<(1500+3σ) ≤OL
Hg	BL≤(700-3σ)<X<(1300+3σ) ≤OL	BL≤(700-3σ)<X<(1300+3σ) ≤OL	BL≤(500-3σ)<X<(1500+3σ) ≤OL
Br	BL≤(300-3σ)<X	--	BL≤(250-3σ)<X
Cr	BL≤(700-3σ)<X	BL≤(700-3σ)<X	BL≤(500-3σ)<X

(c) BL = Below Limit, OL = Over Limit, IN = Inconclusive, LOD = Limit of Detection,  
 -- = Not Regulated, NA = Not Applicable.

(d) The XRF screening test for RoHS elements – The reading may be different to the actual content in the sample be of non-uniformity composition.

- (2) Results are obtained by PHTH for primary screening, and further chemical testing by GC/MS (for DBP,BBP,DEHP and DIBP) is recommended to be performed, if the concentration exceeds the below warning value according to the form below (unit: mg/kg)

Compound	Polymer
DBP	BL≤600<X
BBP	BL≤600<X
DEHP	BL≤600<X
DIBP	BL≤600<X

(3)(a) mg/kg = ppm = 0.0001%, N.D.= Not Detected (<MDL), --- = Not Conducted.

(b) Unit and Method Detection Limit (MDL) in wet chemical test

Test Items	Pb	Cd	Hg	DEHP	BBP	DBP	DIBP
Units	mg/kg	mg/kg	mg/kg	mg/kg	mg/kg	mg/kg	mg/kg
MDL	2	2	2	50	50	50	50

The MDL for single compound of PBBs & PBDEs is 5 mg/kg and MDL of Cr<sup>6+</sup> for polymer & composite sample is 2 mg/kg.

(c) According to IEC 62321-7-1:2015, result on Cr<sup>6+</sup> for metal sample is shown as Positive/Negative.

Positive = Presence of Cr<sup>6+</sup> coating, Negative = Absence of Cr<sup>6+</sup> coating.

#### (4)RoHS Requirement

Restricted substances	Limits
Lead (Pb)	0.1% (1000mg/kg)
Cadmium (Cd)	0.01% (100mg/kg)
Mercury (Hg)	0.1% (1000mg/kg)
Chromium (VI) (Cr <sup>6+</sup> )	0.1% (1000mg/kg)
Polybrominated biphenyls (PBBs)	0.1% (1000mg/kg)
Polybrominated diphenyl ethers (PBDEs)	0.1% (1000mg/kg)
Bis(2-ethylhexyl) phthalate (DEHP)	0.1% (1000mg/kg)
Butyl benzyl phthalate (BBP)	0.1% (1000mg/kg)
Dibutyl phthalate (DBP)	0.1% (1000mg/kg)
Diisobutyl phthalate (DIBP)	0.1% (1000mg/kg)

(5) <sup>①</sup>Electrical and electronic components containing lead in a glass or ceramic other than dielectric ceramic in capacitors, e.g. piezoelectric devices, or in a glass or ceramic matrix compound (RoHS Exemption 7(c)-I).

<sup>②</sup>Copper alloy containing up to 4 % lead by weight (RoHS Exemption 6(c)).

At the request of client, test was conducted on the certain component of submitted sample

<sup>△</sup>The results were copied from the Re-test samples

<sup>(R)</sup>=Re-submitted sample

\*\*\*\*\* To be continued \*\*\*\*\*

## (6)RoHS Exemptions

Exemptions	
RoHS Directive 2011/65/EU ANNEX III and its subsequent amendments	
Exemption Items	Expires Date
1, Mercury in single capped (compact) fluorescent lamps not exceeding (per burner):	
1(a), For general lighting purposes < 30 W:2.5 mg	
1(b), For general lighting purposes $\geq$ 30 W and < 50W:3.5mg	
1(c), For general lighting purposes $\geq$ 50 W and < 150 W: 5 mg	
1(d), For general lighting purposes $\geq$ 150 W: 15 mg	
1(e), For general lighting purposes with circular or square structural shape and tube diameter $\leq$ 17 mm: 7 mg	
1(f), For special purposes: 5 mg	
1(g), For general lighting purposes < 30 W with a lifetime equal or above 20 000 h: 3,5 mg	Expires on 31 December 2017
2(a), Mercury in double-capped linear fluorescent lamps for general lighting purposes not exceeding (per lamp):	
2(a)(1), Tri-band phosphor with normal lifetime and a tube diameter < 9 mm (e.g. T2): 4 mg	
2(a)(2), Tri-band phosphor with normal lifetime and a tube diameter $\geq$ 9 mm and $\leq$ 17 mm (e.g. T5): 3 mg	
2(a)(3), Tri-band phosphor with normal lifetime and a tube diameter > 17 mm and $\leq$ 28 mm (e.g. T8):3.5mg	
2(a)(4), Tri-band phosphor with normal lifetime and a tube diameter > 28 mm (e.g. T12): 3.5 mg	
2(a)(5), Tri-band phosphor with long lifetime ( $\geq$ 25 000 h): 5 mg	
2(b), Mercury in other fluorescent lamps not exceeding (per lamp):	
2(b)(2), Non-linear halophosphate lamps (all diameters): 15 mg	Expires on 13 April 2016
2(b)(3), Non-linear tri-band phosphor lamps with tube diameter > 17 mm (e.g. T9):15mg	
2(b)(4), Lamps for other general lighting and special purposes (e.g. induction lamps):15mg	
3, Mercury in cold cathode fluorescent lamps and external electrode fluorescent lamps (CCFL and EEFL) for special purposes not exceeding (per lamp):	
3(a), Short length ( $\leq$ 500 mm):3.5mg	
3(b), Medium length (> 500 mm and $\leq$ 1 500 mm):5mg	
3(c), Long length (> 1 500 mm):13mg	
4(a), Mercury in other low pressure discharge lamps (per lamp):15mg	
4(b), Mercury in High Pressure Sodium (vapour) lamps for general lighting purposes not exceeding (per burner) in lamps with improved colour rendering index Ra > 60:	
4(b) -I, P $\leq$ 155 W:30mg	
4(b) -II, 155 W < P $\leq$ 405 W:40mg	
4(b) -III, P > 405 W:40mg	
4(c), Mercury in other High Pressure Sodium (vapour) lamps for general lighting purposes not exceeding (per burner):	
4(c)-I, P $\leq$ 155 W:25mg	
4(c)-II, 155 W < P $\leq$ 405 W:30mg	

STQ Testing Services Co., Ltd.

Add.: Building 1, 15 Yinzhu Road, High-new district, Suzhou, China 215129

Tel.:+86/(0)512 67991866

Fax: +86/(0)512 87661802

Web:www.stq-cert.com

 Technical service: [TS@stq-cert.com](mailto:TS@stq-cert.com)

 Customer service: [CS@stq-cert.com](mailto:CS@stq-cert.com)

Exemptions	
RoHS Directive 2011/65/EU ANNEX III and its subsequent amendments	
Exemption Items	Expires Date
4(c)-III, P > 405 W:40mg	
4(e), Mercury in metal halide lamps (MH)	
4(f), Mercury in other discharge lamps for special purposes not specifically mentioned in this Annex	
4(g), Mercury in hand crafted luminous discharge tubes used for signs, decorative or architectural and specialist lighting and light-artwork, where the mercury content shall be limited as follows: (a) 20 mg per electrode pair+0,3mg per tube length in cm, but not more than 80 mg, for outdoor applications and indoor applications exposed to temperatures below 20 °C; (b) 15 mg per electrode pair+0,24mg per tube length in cm, but not more than 80 mg, for all other indoor applications	Expires on 31 December 2018'
5(a), Lead in glass of cathode ray tubes	
5(b), Lead in glass of fluorescent tubes not exceeding 0,2 % by weight	
6(a), Lead as an alloying element in steel for machining purposes and in galvanized steel containing up to 0,35 % lead by weight	Expires on: — 21 July 2021 for categories 8 and 9 other than in vitro diagnostic medical devices and industrial monitoring and control instruments; — 21 July 2023 for category 8 in vitro diagnostic medical devices; — 21 July 2024 for category 9 industrial monitoring and control instruments, and for category 11.
6(a)-I, Lead as an alloying element in steel for machining purposes containing up to 0,35 % lead by weight and in batch hot dip galvanised steel components containing up to 0,2 % lead by weight	Expires on 21 July 2021 for categories 1-7 and 10.
6(b), Lead as an alloying element in aluminium containing up to 0,4 % lead by weight	Expires on: — 21 July 2021 for categories 8 and 9 other than in vitro diagnostic medical devices and industrial monitoring and control instruments, — 21 July 2023 for category 8 in vitro diagnostic medical devices, — 21 July 2024 for category 9 industrial monitoring and control instruments, and for category 11.
6(b)-I Lead as an alloying element in aluminium containing up to 0,4 % lead by weight, provided it stems from lead-bearing aluminium scrap recycling	Expires on 21 July 2021 for categories 1-7 and 10.
6(b)-II Lead as an alloying element in aluminium for machining purposes with a lead content up to 0,4 % by weight	Expires on 18 May 2021 for categories 1-7 and 10

Exemptions	
RoHS Directive 2011/65/EU ANNEX III and its subsequent amendments	
Exemption Items	Expires Date
6(c), Copper alloy containing up to 4 % lead by weight	Expires on: — 21 July 2021 for categories 1-7 and 10, —21 July 2021 for categories 8 and 9 other than in vitro diagnostic medical devices and industrial monitoring and control instruments, —21 July 2023 for category 8 in vitro diagnostic medical devices, — 21 July 2024 for category 9 industrial monitoring and control instruments, and for category 11.
7(a), Lead in high melting temperature type solders (i.e. lead- based alloys containing 85 % by weight or more lead)	Applies to categories 1-7 and 10 (except applications covered by point 24 of this Annex) and expires on 21 July 2021. For categories 8 and 9 other than in vitro diagnostic medical devices and industrial monitoring and control instruments expires on 21 July 2021. For category 8 in vitro diagnostic medical devices expires on 21 July 2023. For category 9 industrial monitoring and control instruments, and for category 11 expires on 21 July 2024.
7(b), Lead in solders for servers, storage and storage array systems, network infrastructure equipment for switching, signalling, transmission, and network management for telecommunications	
7(c)-I, Electrical and electronic components containing lead in a glass or ceramic other than dielectric ceramic in capacitors, e.g. piezoelectronic devices, or in a glass or ceramic matrix compound	Applies to categories 1-7 and 10 (except applications covered under point 34) and expires on 21 July 2021. For categories 8 and 9 other than in vitro diagnostic medical devices and industrial monitoring and control instruments expires on 21 July 2021. For category 8 in vitro diagnostic medical devices expires on 21 July 2023. For category 9 industrial monitoring and control instruments, and for category 11 expires on 21 July 2024.

<b>Exemptions</b>	
RoHS Directive 2011/65/EU ANNEX III and its subsequent amendments	
<b>Exemption Items</b>	<b>Expires Date</b>
7(c)-II, Lead in dielectric ceramic in capacitors for a rated voltage of 125 V AC or 250 V DC or higher	Does not apply to applications covered by point 7(c)-I and 7(c)-IV of this Annex. Expires on: — 21 July 2021 for categories 1-7 and 10; —21 July 2021 for categories 8 and 9 other than in vitro diagnostic medical devices and industrial monitoring and control instruments; — 21 July 2023 for category 8 in vitro diagnostic medical devices; — 21 July 2024 for category 9 industrial monitoring and control instruments, and for category 11.
7(c)-III, Lead in dielectric ceramic in capacitors for a rated voltage of less than 125 V AC or 250 V DC	Expires on 1 January 2013 and after that date may be used in spare parts for EEE placed on the market before 1 January 2013
7(c)-IV, Lead in PZT based dielectric ceramic materials for capacitors being part of integrated circuits or discrete semiconductors	Expires on: — 21 July 2021 for categories 1-7 and 10; —21 July 2021 for categories 8 and 9 other than in vitro diagnostic medical devices and industrial monitoring and control instruments; — 21 July 2023 for category 8 in vitro diagnostic medical devices; — 21 July 2024 for category 9 industrial monitoring and control instruments, and for category 11.
8(a), Cadmium and its compounds in one shot pellet type thermal cut-offs	Expires on 1 January 2012 and after that date may be used in spare parts for EEE placed on the market before 1 January 2012
8(b), Cadmium and its compounds in electrical contacts	Applies to categories 8, 9 and 11 and expires on: — 21 July 2021 for categories 8 and 9 other than in vitro diagnostic medical devices and industrial monitoring and control instruments; — 21 July 2023 for category 8 in vitro diagnostic medical devices; — 21 July 2024 for category 9 industrial monitoring and control instruments, and for category 11.

Exemptions	
RoHS Directive 2011/65/EU ANNEX III and its subsequent amendments	
Exemption Items	Expires Date
8(b)-I Cadmium and its compounds in electrical contacts used in: — circuit breakers, — thermal sensing controls, — thermal motor protectors (excluding hermetic thermal motor protectors), — AC switches rated at: — 6 A and more at 250 V AC and more, or — 12 A and more at 125 V AC and more, — DC switches rated at 20 A and more at 18 V DC and more, and — switches for use at voltage supply frequency $\geq$ 200 Hz.	Applies to categories 1 to 7 and 10 and expires on 21 July 2021.
9, Hexavalent chromium as an anticorrosion agent of the carbon steel cooling system in absorption refrigerators up to 0,75 % by weight in the cooling solution	
9(b), Lead in bearing shells and bushes for refrigerant- containing compressors for heating, ventilation, air conditioning and refrigeration (HVACR) applications	Applies to categories 8, 9 and 11; expires on: — 21 July 2023 for category 8 in vitro diagnostic medical devices, —21 July 2024 for category 9 industrial monitoring and control instruments and for category 11, —21 July 2021 for other subcategories of categories 8 and 9.
9(b)-(I), Lead in bearing shells and bushes for refrigerant- containing hermetic scroll compressors with a stated electrical power input equal or below 9 kW for heating, ventilation, air conditioning and refrigeration (HVACR) applications	Applies to category 1; expires on 21 July 2019.'
11(a), Lead used in C-press compliant pin connector systems	May be used in spare parts for EEE placed on the market before 24 September 2010
11(b), Lead used in other than C-press compliant pin connector systems	Expires on 1 January 2013 and after that date may be used in spare parts for EEE placed on the market before 1 January 2013
12, Lead as a coating material for the thermal conduction module C-ring	May be used in spare parts for EEE placed on the market before 24 September 2010



Exemptions	
RoHS Directive 2011/65/EU ANNEX III and its subsequent amendments	
Exemption Items	Expires Date
13(a), Lead in white glasses used for optical applications	Applies to all categories; expires on: — 21 July 2023 for category 8 in vitro diagnostic medical devices; —21 July 2024 for category 9 industrial monitoring and control instruments and for category 11; — 21 July 2021 for all other categories and subcategories
13(b),Cadmium and lead in filter glasses and glasses used for reflectance standards	Applies to categories 8, 9 and 11; expires on: — 21 July 2023 for category 8 in vitro diagnostic medical devices; —21 July 2024 for category 9 industrial monitoring and control instruments and for category 11; —21 July 2021 for other subcategories of categories 8 and 9
13(b)-(I),Lead in ion coloured optical filter glass types	Applies to categories 1 to 7 and 10; expires on 21 July 2021 for categories 1 to 7 and 10'
13(b)-(II) ,Cadmium in striking optical filter glass types; excluding applications falling under point 39 of this Annex	Applies to categories 1 to 7 and 10; expires on 21 July 2021 for categories 1 to 7 and 10'
13(b)-(III), Cadmium and lead in glazes used for reflectance standards	Applies to categories 1 to 7 and 10; expires on 21 July 2021 for categories 1 to 7 and 10'
14, Lead in solders consisting of more than two elements for the connection between the pins and the package of micropro-cessors with a lead content of more than 80 % and less than 85 % by weight	Expires on 1 January 2011 and after that date may be used in spare parts for EEE placed on the market before 1 January 2011

Exemptions	
RoHS Directive 2011/65/EU ANNEX III and its subsequent amendments	
Exemption Items	Expires Date
15, Lead in solders to complete a viable electrical connection between semiconductor die and carrier within integrated circuit flip chip packages	Applies to categories 8, 9 and 11 and expires on: — 21 July 2021 for categories 8 and 9 other than in vitro diagnostic medical devices and industrial monitoring and control instruments; — 21 July 2023 for category 8 in vitro diagnostic medical devices; — 21 July 2024 for category 9 industrial monitoring and control instruments, and for category 11.
15(a) Lead in solders to complete a viable electrical connection between the semiconductor die and carrier within integrated circuit flip chip packages where at least one of the following criteria applies: — a semiconductor technology node of 90 nm or larger; — a single die of 300 mm <sup>2</sup> or larger in any semiconductor technology node; — stacked die packages with die of 300 mm <sup>2</sup> or larger, or silicon interposers of 300 mm <sup>2</sup> or larger.	Applies to categories 1 to 7 and 10 and expires on 21 July 2021.
17, Lead halide as radiant agent in high intensity discharge (HID) lamps used for professional reprography applications	
18(b), Lead as activator in the fluorescent powder (1 % lead by weight or less) of discharge lamps when used as sun tanning lamps containing phosphors such as BSP (BaSi <sub>2</sub> O <sub>5</sub> :Pb)	Expires on: — 21 July 2021 for categories 1-7 and 10; — 21 July 2021 for categories 8 and 9 other than in vitro diagnostic medical devices and industrial monitoring and control instruments; — 21 July 2023 for category 8 in vitro diagnostic medical devices; — 21 July 2024 for category 9 industrial monitoring and control instruments, and for category 11.
18(b)-I Lead as activator in the fluorescent powder (1 % lead by weight or less) of discharge lamps containing phosphors such as BSP (BaSi <sub>2</sub> O <sub>5</sub> :Pb) when used in medical phototherapy equipment	Applies to categories 5 and 8, excluding applications covered by entry 34 of Annex IV, and expires on 21 July 2021.
21, Lead and cadmium in printing inks for the application of enamels on glasses, such as borosilicate and soda lime glasses	Applies to categories 8, 9 and 11 and expires on: — 21 July 2021 for categories 8 and 9 other than in vitro diagnostic medical devices and industrial monitoring and control instruments; — 21 July 2023 for category 8 in vitro diagnostic medical devices; — 21 July 2024 for category 9 industrial monitoring and control instruments, and for category 11.

Exemptions	
RoHS Directive 2011/65/EU ANNEX III and its subsequent amendments	
Exemption Items	Expires Date
21(a) Cadmium when used in colour printed glass to provide filtering functions, used as a component in lighting applications installed in displays and control panels of EEE	Applies to categories 1 to 7 and 10 except applications covered by entry 21(b) or entry 39 and expires on 21 July 2021.
21(b) Cadmium in printing inks for the application of enamels on glasses, such as borosilicate and soda lime glasses	Applies to categories 1 to 7 and 10 except applications covered by entry 21(a) or 39 and expires on 21 July 2021.
21(c) Lead in printing inks for the application of enamels on other than borosilicate glasses	Applies to categories 1 to 7 and 10 and expires on 21 July 2021.
23, Lead in finishes of fine pitch components other than connectors with a pitch of 0,65 mm and less	May be used in spare parts for EEE placed on the market before 24 September 2010
24, Lead in solders for the soldering to machined through hole discoidal and planar array ceramic multilayer capacitors	Expires on: — 21 July 2021 for categories 1-7 and 10, — 21 July 2021 for categories 8 and 9 other than in vitro diagnostic medical devices and industrial monitoring and control instruments, — 21 July 2023 for category 8 in vitro diagnostic medical devices, — 21 July 2024 for category 9 industrial monitoring and control instruments, and for category 11.
25, Lead oxide in surface conduction electron emitter displays (SED) used in structural elements, notably in the seal frit and frit ring	
29, Lead bound in crystal glass as defined in Annex I (Categories 1, 2, 3 and 4) of Council Directive 69/493/EEC <sup>(1)</sup>	Expires on: — 21 July 2021 for categories 1-7 and 10; — 21 July 2021 for categories 8 and 9 other than in vitro diagnostic medical devices and industrial monitoring and control instruments; — 21 July 2023 for category 8 in vitro diagnostic medical devices; — 21 July 2024 for category 9 industrial monitoring and control instruments, and for category 11.
30, Cadmium alloys as electrical/mechanical solder joints to electrical conductors located directly on the voice coil in transducers used in high-powered loudspeakers with sound pressure levels of 100 dB (A) and more	
31, Lead in soldering materials in mercury free flat fluorescent lamps (which e.g. are used for liquid crystal displays, design or industrial lighting)	

Exemptions	
RoHS Directive 2011/65/EU ANNEX III and its subsequent amendments	
Exemption Items	Expires Date
32, Lead oxide in seal frit used for making window assemblies for Argon and Krypton laser tubes	Expires on: — 21 July 2021 for categories 1-7 and 10, — 21 July 2021 for categories 8 and 9 other than in vitro diagnostic medical devices and industrial monitoring and control instruments, — 21 July 2023 for category 8 in vitro diagnostic medical devices, —21 July 2024 for category 9 industrial monitoring and control instruments, and for category 11.
33, Lead in solders for the soldering of thin copper wires of 100 μm diameter and less in power transformers	
34, Lead in cermet-based trimmer potentiometer elements	Applies to all categories; expires on: — 21 July 2021 for categories 1-7 and 10, —21 July 2021 for categories 8 and 9 other than in vitro diagnostic medical devices and industrial monitoring and control instruments, —21 July 2023 for category 8 in vitro diagnostic medical devices, — 21 July 2024 for category 9 industrial monitoring and control instruments, and for category 11.
37, Lead in the plating layer of high voltage diodes on the basis of a zinc borate glass body	Expires on: — 21 July 2021 for categories 1-7 and 10; — 21 July 2021 for categories 8 and 9 other than in vitro diagnostic medical devices and industrial monitoring and control instruments; — 21 July 2023 for category 8 in vitro diagnostic medical devices; — 21 July 2024 for category 9 industrial monitoring and control instruments, and for category 11.
38, Cadmium and cadmium oxide in thick film pastes used on aluminium bonded beryllium oxide	
39(a), Cadmium selenide in downshifting cadmium-based semiconductor nanocrystal quantum dots for use in display lighting applications (< 0,2 μg Cd per mm <sup>2</sup> of display screen area)	Expires for all categories on 31 October 2019.

Exemptions	
RoHS Directive 2011/65/EU ANNEX III and its subsequent amendments	
Exemption Items	Expires Date
41, Lead in solders and termination finishes of electrical and electronic components and finishes of printed circuit boards used in ignition modules and other electrical and electronic engine control systems, which for technical reasons must be mounted directly on or in the crankcase or cylinder of hand-held combustion engines (classes SH:1, SH:2, SH:3 of Directive 97/68/EC of the European Parliament and of the Council)	Expires on 31 December 2018
42 Lead in bearings and bushes of diesel or gaseous fuel powered internal combustion engines applied in non-road professional use equipment: — with engine total displacement $\geq$ 15 litres; or — with engine total displacement < 15 litres and the engine is designed to operate in applications where the time between signal to start and full load is required to be less than 10 seconds; or regular maintenance is typically performed in a harsh and dirty outdoor environment, such as mining, construction, and agriculture application	Applies to category 11, excluding applications covered by entry 6(c) of this Annex. Expires on 21 July 2024.
Note: <sup>(1)</sup> OJ L 326, 29.12.1969, p.36.	

Exemptions	
RoHS Directive 2011/65/EU ANNEX IV and its subsequent amendments Equipment ionizing or detecting ionizing radiation	
Exemption Items	Expires Date
1. Lead, cadmium and mercury in detectors for ionizing radiation.	
2. Lead bearings in X-ray tubes.	
3. Lead in electromagnetic radiation amplification devices: micro-channel plate and capillary plate.	
4. Lead in glass frit of X-ray tubes and image intensifiers and lead in glass frit binder for assembly of gas lasers and for vacuum tubes that convert electromagnetic radiation into electrons.	
5. Lead in shielding for ionizing radiation.	
6. Lead in X-ray test objects.	
7. Lead stearate X-ray diffraction crystals.	
8. Radioactive cadmium isotope source for portable X-ray fluorescence spectrometers. Sensors, detectors and electrodes	
8.1a. Lead and cadmium in ion selective electrodes including glass of pH electrodes.	
8.1b. Lead anodes in electrochemical oxygen sensors.	
8.1c. Lead, cadmium and mercury in infra-red light detectors.	

STQ Testing Services Co., Ltd.

Add.: Building 1, 15 Yinzhong Road, High-new district, Suzhou, China 215129

Tel.: +86/(0)512 67991866

Fax: +86/(0)512 87661802

Web: [www.stq-cert.com](http://www.stq-cert.com)

Technical service: [TS@stq-cert.com](mailto:TS@stq-cert.com)

Customer service: [CS@stq-cert.com](mailto:CS@stq-cert.com)

Exemptions	
RoHS Directive 2011/65/EU ANNEX IV and its subsequent amendments Equipment ionizing or detecting ionizing radiation	
Exemption Items	Expires Date
8.1d. Mercury in reference electrodes: low chloride mercury chloride, mercury sulphate and mercury oxide.	
9. Cadmium in helium-cadmium lasers.	
10. Lead and cadmium in atomic absorption spectroscopy lamps.	
11. Lead in alloys as a superconductor and thermal conductor in MRI.	
12. Lead and cadmium in metallic bonds creating superconducting magnetic circuits in MRI, SQUID, NMR (Nuclear Magnetic Resonance) or FTMS (Fourier Transform Mass Spectrometer) detectors.	Expires on 30 June 2021
13. Lead in counterweights.	
14. Lead in single crystal piezoelectric materials for ultrasonic transducers.	
15. Lead in solders for bonding to ultrasonic transducers.	
16. Mercury in very high accuracy capacitance and loss measurement bridges and in high frequency RF switches and relays in monitoring and control instruments not exceeding 20 mg of mercury per switch or relay.	
17. Lead in solders in portable emergency defibrillators.	
18. Lead in solders of high performance infrared imaging modules to detect in the range 8-14 $\mu\text{m}$ .	
19. Lead in Liquid crystal on silicon (LCoS) displays.	
20. Cadmium in X-ray measurement filters.	
21. Cadmium in phosphor coatings in image intensifiers for X-ray images until 31 December 2019 and in spare parts for X-ray systems placed on the EU market before 1 January 2020.	
22. Lead acetate marker for use in stereotactic head frames for use with CT and MRI and in positioning systems for gamma beam and particle therapy equipment.	Expires on 30 June 2021.
23. Lead as an alloying element for bearings and wear surfaces in medical equipment exposed to ionising radiation.	Expires on 30 June 2021
24. Lead enabling vacuum tight connections between aluminium and steel in X-ray image intensifiers.	Expires on 31 December 2019
25. Lead in the surface coatings of pin connector systems requiring nonmagnetic connectors which are used durably at a temperature below $-20\text{ }^{\circ}\text{C}$ under normal operating and storage conditions.	Expires on 30 June 2021
26. Lead in the following applications that are used durably at a temperature below $-20\text{ }^{\circ}\text{C}$ under normal operating and storage conditions: (a) solders on printed circuit boards; (b) termination coatings of electrical and electronic components and coatings of printed circuit boards; (c) solders for connecting wires and cables; (d) solders connecting transducers and sensors. Lead in solders of electrical connections to temperature measurement sensors in devices which are designed to be used periodically at temperatures below $-150\text{ }^{\circ}\text{C}$ .	Expires on 30 June 2021

Exemptions	
RoHS Directive 2011/65/EU ANNEX IV and its subsequent amendments Equipment ionizing or detecting ionizing radiation	
Exemption Items	Expires Date
27. Lead in — solders, — termination coatings of electrical and electronic components and printed circuit boards, — connections of electrical wires, shields and enclosed connectors, which are used in magnetic fields within the sphere of 1 m radius around the isocentre of the magnet in medical magnetic resonance imaging equipment, including patient monitors designed to be used within this sphere, or magnetic fields within 1 m distance from the external surfaces of cyclotron magnets, magnets for beam transport and beam direction control applied for particle therapy.	Expires on 30 June 2020
28. Lead in solders for mounting cadmium telluride and cadmium zinc telluride digital array detectors to printed circuit boards.	Expires on 31 December 2017
29. Lead in alloys, as a superconductor or thermal conductor, used in cryo-cooler cold heads and/or in cryo-cooled cold probes and/or in cryo-cooled equipotential bonding systems, in medical devices (category 8) and/or in industrial monitoring and control instruments.	Expires on 30 June 2021
30. Hexavalent chromium in alkali dispensers used to create photocathodes in X-ray image intensifiers until 31 December 2019 and in spare parts for X-ray systems placed on the EU market before 1 January 2020.	
31a. Lead, cadmium, hexavalent chromium, and polybrominated diphenyl ethers (PBDE) in spare parts recovered from and used for the repair or refurbishment of medical devices, including in vitro diagnostic medical devices, or electron microscopes and their accessories, provided that the reuse takes place in auditable closed-loop business-to-business return systems and that each reuse of parts is notified to the customer.	Expires on: (a) 21 July 2021 for the use in medical devices other than in vitro diagnostic medical devices; (b) 21 July 2023 for the use in in vitro diagnostic medical devices; (c) 21 July 2024 for the use in electron microscopes and their accessories.'
32. Lead in solders on printed circuit boards of detectors and data acquisition units for Positron Emission Tomographs which are integrated into Magnetic Resonance Imaging equipment.	Expires on 31 December 2019
33. Lead in solders on populated printed circuit boards used in Directive 93/42/EEC class IIa and IIb mobile medical devices other than portable emergency defibrillators.	Expires on 30 June 2016 for class IIa and on 31 December 2020 for class IIb.
34. Lead as an activator in the fluorescent powder of discharge lamps when used for extracorporeal photopheresis lamps containing BSP (BaSi <sub>2</sub> O <sub>5</sub> :Pb) phosphors.	Expires on 22 July 2021
35. Mercury in cold cathode fluorescent lamps for back-lighting liquid crystal displays, not exceeding 5 mg per lamp, used in industrial monitoring and control instruments placed on the market before 22 July 2017	Expires on 21 July 2024



Exemptions	
RoHS Directive 2011/65/EU ANNEX IV and its subsequent amendments Equipment ionizing or detecting ionizing radiation	
Exemption Items	Expires Date
36. Lead used in other than C-press compliant pin connector systems for industrial monitoring and control instruments.	Expires on 31 December 2020. May be used after that date in spare parts for industrial monitoring and control instruments placed on the market before 1 January 2021.'
37. Lead in platinized platinum electrodes used for conductivity measurements where at least one of the following conditions applies: (a) wide-range measurements with a conductivity range covering more than 1 order of magnitude (e.g. range between 0,1 mS/m and 5 mS/m) in laboratory applications for unknown concentrations; (b) measurements of solutions where an accuracy of +/- 1 % of the sample range and where high corrosion resistance of the electrode are required for any of the following: (i) solutions with an acidity < pH 1; (ii) solutions with an alkalinity > pH 13; (iii) corrosive solutions containing halogen gas; (c) measurements of conductivities above 100 mS/m that must be performed with portable instruments.	Expires on 31 December 2018
38. Lead in solder in one interface of large area stacked die elements with more than 500 interconnects per interface which are used in X-ray detectors of computed tomography and X-ray systems	Expires on 31 December 2019. May be used after that date in spare parts for CT and X-ray systems placed on the market before 1 January 2020.



Exemptions	
RoHS Directive 2011/65/EU ANNEX IV and its subsequent amendments Equipment ionizing or detecting ionizing radiation	
Exemption Items	Expires Date
<p>39. Lead in micro-channel plates (MCPs) used in equipment where at least one of the following properties is present:</p> <p>(a) a compact size of the detector for electrons or ions, where the space for the detector is limited to a maximum of 3 mm/MCP (detector thickness+space for installation of the MCP), a maximum of 6 mm in total, and an alternative design yielding more space for the detector is scientifically and technically impracticable;</p> <p>(b) a two-dimensional spatial resolution for detecting electrons or ions, where at least one of the following applies:</p> <p>(i) a response time shorter than 25 ns;</p> <p>(ii) a sample detection area larger than 149 mm<sup>2</sup>;</p> <p>(iii) a multiplication factor larger than <math>1,3 \times 10^3</math>.</p> <p>(c) a response time shorter than 5 ns for detecting electrons or ions;</p> <p>(d) a sample detection area larger than 314 mm<sup>2</sup> for detecting electrons or ions;</p> <p>(e) a multiplication factor larger than <math>4,0 \times 10^7</math>.</p>	<p>(a) 21 July 2021 for medical devices and monitoring and control instruments;</p> <p>(b) 21 July 2023 for in-vitro diagnostic medical devices;</p> <p>(c) 21 July 2024 for industrial monitoring and control instruments</p>
40. Lead in dielectric ceramic in capacitors for a rated voltage of less than 125 V AC or 250 V DC for industrial monitoring and control instruments	Expires on 31 December 2020. May be used after that date in spare parts for industrial monitoring and control instruments placed on the market before 1 January 2021
41. Lead as a thermal stabiliser in polyvinyl chloride (PVC) used as base material in amperometric, potentiometric and conductometric electrochemical sensors which are used in in-vitro diagnostic medical devices for the analysis of blood and other body fluids and body gases.	Expires on 31 December 2018
42. Mercury in electric rotating connectors used in intravascular ultrasound imaging systems capable of high operating frequency (> 50 MHz) modes of operation.	Expires on 30 June 2019
43. Cadmium anodes in Hersch cells for oxygen sensors used in industrial monitoring and control instruments, where sensitivity below 10 ppm is required.	Expires on 15 July 2023

\*\*\*\*\* To be continued \*\*\*\*\*

**TESTED MAIN MODEL'S PRODUCT PHOTO****TESTED OTHER MODEL'S PRODUCT PHOTO**

\*\*\*\*\* **END OF REPORT** \*\*\*\*\*



# TEST REPORT

Reference No. : SZ2019100837-1E

Date : Nov. 08, 2019

Page No.: 59 of 60

## GENERAL CONDITIONS OF SERVICES

STQ Testing Services Co.,Ltd. (hereinafter "STQ"), while reserving the right to decline, without giving any reason whatsoever, any request for the undertaking of a test or investigation, will carry out at the request of the clients the required test or investigation subject always to the following conditions:

1. STQ only acts for the person or body originating the instructions (the "Clients"). No other party is entitled to give instructions, particularly on the scope of testing or delivery of report or certificate, unless authorized by the Clients.
2. The Sample(s) to be tested or investigated shall be delivered at the costs of the Clients and in accordance with the requirements of STQ. Improper shipping, packaging, and labeling of the Sample(s) by the Client may result in incorrect testing results, STQ shall be under no obligation to the Clients. At the conclusion of the test or investigation, the Clients shall, if required by STQ, collect the Sample(s). In any event, if the Sample(s) are not collected by the Clients within 60 days from the issuance date of the test report (for perishable items such as food and water samples, the relevant period shall be the preserving period up to 15 days), STQ may at its discretion dispose of the Sample(s) without any compensation to the Clients.
3. The Clients shall always comply with the following before or during STQ providing its services:
  - a) provide sample(s) and relevant data, at the same time, guarantee the consistence of the sample(s)' name they declared with the sample(s) or the goods provided. Otherwise, STQ will not bear any relevant responsibilities;
  - b) giving timely instructions and adequate information to enable STQ to perform the services effectively;
  - c) supply, when requested by STQ, any equipment and personnel for the performance of the services;
  - d) take all necessary steps to eliminate or remedy any obstruction in the performance of the services;
  - e) inform STQ in advance of any hazards or dangers, actual or potential, associated with any order of samples or testing;
  - f) provide all necessary access for STQ's representative to enable the required services to be performed effectively;
  - g) ensure all essential steps are taken for safety of working conditions, sites and installations during the performance of services;
  - h) fully discharge all its liabilities under any contract like sales contract with a third party, whether or not a report or certificate has been issued by STQ, failing which STQ shall be under no obligation to the Clients.
4. Subject to STQ's accepting the Client's instructions, STQ will issue reports or certificates which reflect statements of opinion made with due care within the scope of instructions but STQ is not obliged to report upon any facts outside the instructions, if there were any dissidence about the report or certificate, the Client should provide the written declaration to STQ within 15 days after the date receiving the report or certificate, otherwise, STQ will not hear the case after the date limit.
5. STQ is irrevocably authorized by the Clients to deliver at its discretion the report or the certificate to any third party when instructed by the Clients or where it implicitly follows from circumstances, trade custom, usage or practice as determined by STQ.
6. A test report will be issued in confidence to the Clients and it will be strictly treated as such by STQ. It may not be reproduced either in its entirety or in part and it may not be used for advertising or other unauthorized purposes without the written consent of STQ. The Clients to whom the Report is issued may, however, show or send it, or a certified copy thereof prepared by STQ, to his customer, supplier or other persons directly concerned. STQ will not, without the consent of the Clients, enter into any discussion or correspondence with any third party concerning the contents of the report unless required by the relevant governmental authorities, laws or court orders.
7. Applicants wishing to use STQ's reports in court proceedings or arbitration shall inform STQ to that effect prior to submitting the sample for testing.
8. The report will refer only to the sample tested and will not apply to the bulk, unless the sampling has been carried out by STQ and is stated as such in the Report. Also, the report is only for reference.
9. Any documents containing engagements between the Clients and third parties like contracts of sale, letters of credit, bills of lading, etc. are regarded as information for STQ only and do not affect the scope of the services or the obligations accepted by STQ.
10. If the Clients do not specify the methods/standards to be applied, STQ will choose the appropriate ones and further information regarding the methods can be obtained by direct contact with STQ, for the in-house method, STQ will only provide the summary.
11. No liability shall be incurred by and no claim shall be made against STQ or its servants, agents, employees or independent contractors in respect of any loss or damage to any such materials, equipment and property occurring whilst at STQ or any work places in which the testing is carried out, or in the course of transit to or from STQ or the said work places, whether or not resulting from any acts, neglect or default on the part of any such servants, agents, employees or independent contractors of STQ.
12. STQ will not be liable, or accept responsibility for any loss or damage howsoever arising from the use of information contained in any of its reports or in any communication whatsoever about its said tests or investigations.
13. Subject to Clause 11 and 12, the total liability of STQ in respect of any claim of loss, damage or expense of whatsoever nature shall not exceed a total sum equal to two times the amount of the service fee payable in respect of the services directly related to such claim, and STQ's liability shall not include any indirect, special or consequential loss of the Clients.
14. In the event of STQ prevented by any cause outside STQ's control from performing any service for which an order has been given or an agreement made, the Clients shall pay to STQ:
  - a) the amount of all abortive expenditure actually made or incurred;
  - b) a proportion of the agreed fee or commission equal to the proportion (if any) of the service actually carried out by STQ, and STQ shall be relieved of all responsibility whatsoever for the partial or total non-performance of the required service.
15. STQ shall be discharged from all liabilities for all claims for loss, damage or expense unless suit is brought within one calendar year after the date of the performance by STQ of the service relating to the claim or in the event of any alleged non-performance within one year of the date when such service should have been completed.

STQ Testing Services Co., Ltd.

Add.: Building 1, 15 Yinzhong Road, High-new district, Suzhou, China 215129

Tel.: +86/(0)512 67991866

Fax: +86/(0)512 87661802

Web: [www.stq-cert.com](http://www.stq-cert.com)

Technical service: [TS@stq-cert.com](mailto:TS@stq-cert.com)

Customer service: [CS@stq-cert.com](mailto:CS@stq-cert.com)



## TEST REPORT

Reference No. : SZ2019100837-1E

Date : Nov. 08, 2019

Page No.: 60 of 60

16. The Clients acknowledge that STQ does not, either by entering into a contract or by performing service, assume or undertake to discharge any duty of the Clients to any other persons. STQ is neither an insurer nor a guarantor and disclaims all liability in such capacity.
17. The Clients shall hold harmless and indemnify STQ and its officers, employees, agents or independent contractors against all claims made by any third party for loss, damage or expense of whatsoever nature including reasonable legal expenses relating to the performance or non-performance of any services to the extent that the aggregate of any such claims relating to any one service exceed the limits mentioned in Clause 13.
18. Any unauthorized alteration, forgery or falsification of the content or appearance of the report/certificate is unlawful and offenders may be prosecuted to the fullest extent of the law; in the event of improper use of the report, STQ reserves the right to withdraw it, and to adopt any other measures which may be appropriate.
19. Samples are deposited with and accepted by STQ on the basis that either they are insured by the Clients or the Clients assumes entire responsibility for loss through fire, theft, burglary or for damages arising in the course of analysis or handling, without recourse whatsoever to STQ or its servants, agent, employees or independent contractors.
20. If the requirements of the Clients require the analysis of samples by the Clients' or any third party's laboratory, STQ will only convey the result of the analysis without responsibility for its accuracy. If STQ is only able to witness an analysis by the Clients' or any third Party's laboratory STQ will only confirm that the correct sample has been analyzed without responsibility for the accuracy of any analysis or results.
21. In the event of any unforeseen additional time or costs being incurred in the course of carrying out any of its services, STQ shall be entitled to charge the Clients additional fees to reflect the additional time and costs incurred.
22. All rights (including but not limited to copyright) in any reports, certificates or other materials produced by STQ in the course of providing its services shall remain vested in STQ.
23. Unless otherwise agreed in writing, payment is to be made within 10 days from the date of Invoice or the date of the Debit Note, all charges rendered by STQ or interest will become due at the rate of three percent per month from the date of invoice until actual payment. The Clients are also responsible for settling all STQ's costs of collecting the charges owed, including legal fees.
24. Test results may be transmitted by electronic means at the Client's request. However, it should be noted that electronic transmission cannot guarantee the information contained will not be lost, delayed or intercepted by third party. STQ is not liable for any disclosure, error or omission in the content of such messages as a result of electronic transmission.
25. If necessary, STQ may subcontract part of or all tests to competent subcontractors. If no objection is raised at the time of the Clients submitting the application, STQ shall assume the Client's approval.
26. This report/certificate does not relieve sellers/suppliers from their contractual responsibility with regards to the quality/quantity of this delivery nor does it prejudice the Client's right to claim towards sellers/suppliers for compensation for any apparent and/or hidden defects not detected during STQ's random inspection or testing or audit.
27. STQ reserves the right to include Special Conditions in addition to the foregoing General Conditions if warranted by the particular circumstances of the required test or investigation [this clause is only effective when the other party has been informed].
28. The foregoing General Conditions shall in all respects be governed, construed, interpreted and operated in accordance with the relevant Chinese laws and regulations. Unless otherwise agreed, the arbitration shall take place in P. R. C
29. These General Condition have been drafted in Chinese and may be translated into other languages. In the event of any discrepancy, the Chinese version shall prevail.
30. In general sample will be stored for 60 days. But for liquid, powder, etc semi-product & fragile product, it will be stored only for 7 days.
31. The effective date of this "GENERAL CONDITIONS OF SERVICES" is 1st May of 2017 and Version 2.0.

STQ Testing Services Co., Ltd.

Add.: Building 1, 15 Yinzhong Road, High-new district, Suzhou, China 215129

Tel.: +86/(0)512 67991866

Fax: +86/(0)512 87661802

Web: [www.stq-cert.com](http://www.stq-cert.com)

Technical service: [TS@stq-cert.com](mailto:TS@stq-cert.com)

Customer service: [CS@stq-cert.com](mailto:CS@stq-cert.com)