

ASSEMBLY INSTRUCTIONS

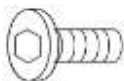

[A] × 8 PCS



M6 × 20

[B] × 6 PCS

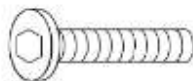

M6 × 45

[C] × 5 PCS

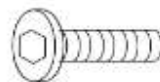

M6 × 35

[D] × 3 PCS

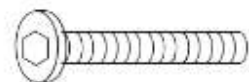

M6 × 55

[E] × 14 PCS



M6

[I] × 12 PCS



[F] × 1 PCS



[J] × 4 PCS



[G] × 1 PCS



[H] × 24 PCS



STEP1

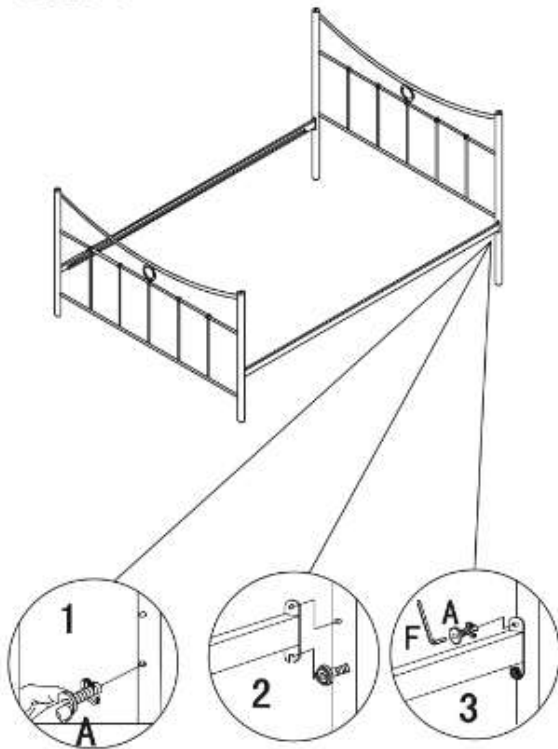

STEP2

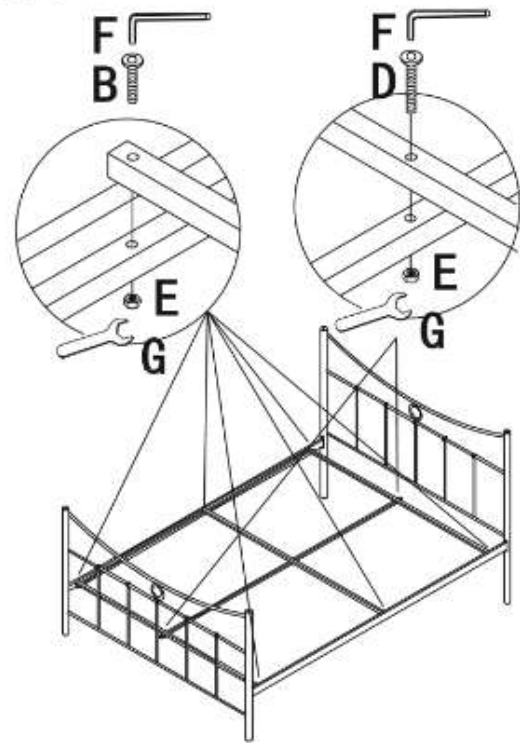

STEP3

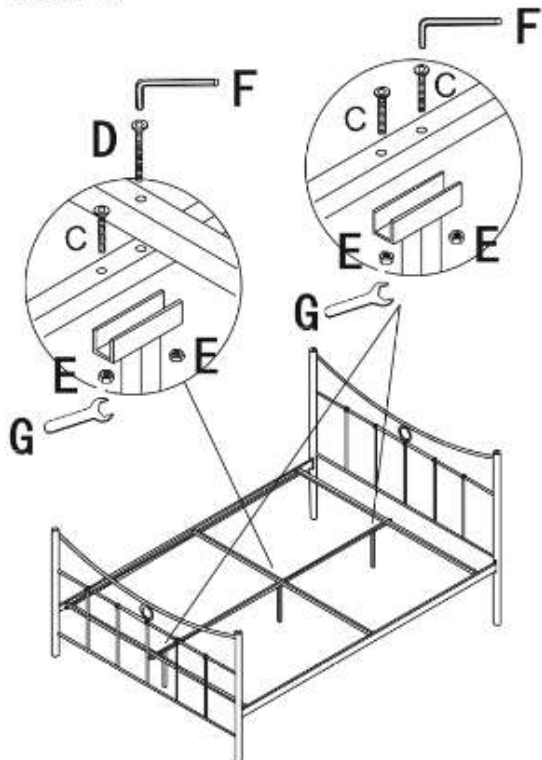

STEP4

