



SWEDIC



SD-P36L 1800W
Professional Machine



© SWEDIC GROUP EUROPE

- FR** Aspirateur à décolmatage (Notice originale)
- EN** Decluttering vacuum cleaner (Original manual translation)
- DE** Decluttering Staubsauger (Übersetzung aus dem Original-Anleitung)
- ES** Aspiradora desordenada (Traducción del manual de instrucciones originale)
- IT** Aspirapolvere di decluttering (Traduzione dell'avvertenza originale)
- PT** Aspirador decluttering (Tradução do livro de instruções original)
- NL** Ophelderende stofzuiger (Vertaling van de originele instructies)
- EL** Ηλεκτρική σκούπα απολύμανσης (Μετάφραση από τις πρωττυπες οδηγίες)
- PL** Odkurzacz do odpryskania (Tłumaczenie z oryginalnej instrukcji)
- FI** Decluttering pölyn imuri (Käännös alkuperäisestä ohjeet)
- SV** Decluttering vysávač (Översättning från originalinstruktioner)
- BU** Прахосмукачка с дефлуинг (Превод на оригиналната инструкция)
- DA** Declurende støvsuger (Oversættelse fra oprindelige brugsanvisning)
- RO** Aspirator de decluttering (Traducere din instrucțiunile originale)
- RU** Захламление пылесоса (Перевод с оригинальной инструкции)
- TU** Decluttering elektrikli süpürge (Orijinal talimatlar çeviri)
- CS** Dectající vysavač (Překlad z originálního návodu)
- SK** Decluttering vysávač (Překlad z originálneho návodu)
- HE** (זמן טעינה) שואב אבק התזה
- AR** (تعليمات استعمال) تم تمجرتال) قهيءايردهك تسننكم
- HU** Decluttering porszívó (Fordítás az eredeti utasítások)
- SL** Decluttering sesalnik (Prevod iz izvornih navodil)
- ET** Vaakum tolmuimeja (Tõlge originaal juhiseid)
- LV** Pramoninis plaunamas dulkių siurblys (Tulkojumā no instrukcijas oriģinālvalodā)
- LT** Vaakum tolmuimeja (Vertimas iš originalių instrukcijas)
- HR** Usisni usisavač (Prijevod prema originalne upute)

SWEDIC GROUP EUROPE

www.swedic.eu



WWW.SWEDIC.EU

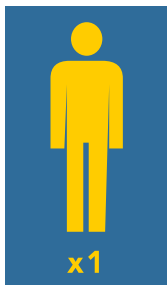

5 min

GARANTIE - WARRANTY



RO. GARANTIE

Acest aparat este garantat din punct de vedere contractual împotriva tuturor viciilor de construcție și de material, începând de la data vânzării lui către utilizator și la simpla prezentare a bonului de casă. Garanția constă în înlocuirea componentelor defecte. Această garanție nu se aplică în cazul exploataării în alt mod decât cel recomandat de normele aparatului și nici în caz de stricăciuni provocate de intervenții neautorizate sau prin neglijența cumpărătorului. Garanția nu se aplică asupra pagbelor cauzate de a defectare a aparatului.

RU. ГАРАНТИЯ

Данное изделие обладает имеющей силу контракта гарантией, покрывающей все возможные дефекты изготовления и материала. Гарантия вступает в силу с даты продажи изделия пользователю, для этого достаточно сохранить и предъявить полученный в кассе чек. Гарантия обязывает изготовителя заменить дефектные части изделия. В случае не соответствующего нормам использования изделия, несанкционированного демонтажа или ремонта или небрежного обращения действие гарантии прекращается. Гарантия не покрывает ущерб, возникшего в результате сбоев в работе изделия.

TU. GARANTI

Bu araç, satış tarihinden itibaren, kullanicının sadece vezne alıncısına sunmasıyla tüm üretim ve malzeme hatasına karşı garantilidir. Garanti eksik olan kısımları değıştirmek içindir. Bu garanti aracın şartlarına uygun olmayan işleme durumunda, izin verilmeyen kullanımlardan kaynaklanan hasarlarda veya alıcının isteğı durumunda uygulanmaz. Garanti malzemenin bir eksikliğınden meydana gelen bir zararda uygulanmaz.

CS. ZÁRUKA

Pro tento nástroj platí smluvní záruka na všechny výrobní a materiálové vady od data prodeje uživateli a na základě předložení pokladního bloku. Záruka spočívá ve výměně vadných částí. Tato záruka neplatí v případě použití přístroje, které neodpovídá normám, ani v případě škod způsobených nepovolenými zásahy nebo nedbalostí ze strany kupujícího. Záruka se nevztahuje na škody způsobené závadou nástroje.

SK. ZÁRUKA

Pre tento nástroj platí zmluvná záruka na všetky výrobné a materiálové chyby od dátumu predaja uživateľovi a na základe predloženia pokladničného bloku. Záruka spočíva vo výmene chybných častí. Táto záruka neplatí v prípade použitia prístroja,

ktoré nezodpovedá normám, ani v prípade škôd spôsobených nepovolenými zásahmi alebo nedbalosťou zo strany kupujúceho. Záruka sa nevztahuje na škody spôsobené poruchou nástroja.

HE. אחריות

עם הצגת חשבונית קופה. האחריות-משמעה בייצור או בחומר,החל מיום המכירה למשתמש לכללי זה חלה אחריות לפי חוזה מפני כל ליקוי ובמקרה של נזק שנגרם על ידי התערבות תללל זה במקרה של שימוש במכשיר שאינו מתאים לתקנים בכלל. החלף תחלקם הלקויים אחריות זו אינה חלה האחריות אינה חלה על נזק שנגרם על ידי תקלה סמכות או על ידי חשלות מאת הקונה.

AR. الضمان

وبناء على مجرد تقديم ببطاقتالشراء يتعامل في عصفىالوجاء. إختيارا من تاريخ البيع الى المستهلك هذه الة مضمونة تعاقدية. من أي عيب في التصني لمعايير الجهاز. ولا في حالة تعرضه للتلفات إن قبلًا للتطبيق في حالة الاستخدام غير المطابق فأي سحبدال الأجزاء الأاطلة لا يكون هذا الضمان لا يطبق الضمان على الخيبر الناتج عن ثلل الضمان تدخل غير مبررة أو في حالة الإهال من قبل المشغري ذاتية عن عطلوات

HU. GARANCIA

Erre a szerszámra szerződéses garanciát vállalunk bármilyen gyártási és anyaghiba felmerülése esetére, a fogyasztó részére történt eladás napjától számítva, a pénztári blokk egyszerű felmutatása ellenében. A garancia a hibás alkatrészek cseréjére terjed ki. Ez a garancia nem érvényes, ha a készüléket nem rendeltetészerűen használták, sem illetéketlen beavatkozások, vagy a vásárló hanyagsága okozta károk esetén. A garancia nem fedezi azokat a károkat, melyeket a szerszám hibás működése okozott.

SI. GARANCIJA

To orodje je z garancijsko pogodbo zaščiteno proti vsem napakam v izdelavi in v sestavnem materialu od datuma prodaje naprej in ta velja ob predložitvi blagajniškega računa . Garancija velja za zamenjavo delov z napako. Ta garancija ne velja za uporabo orodja, ki ni v skladu z normami, predpisanimi za omenjeno orodje in za primere okvar, ki nastanejo zaradi nedovoljenih posegov na orodju ali zaradi malomarnega rokovanja kupca. Garancija ne velja za škodo, ki jo lahko povzročijo okvara orodja.

ET. GARANTII

See tööriist kuulub lepingu järgi garantiiremonti arvestades alates müümise päevast ja kassatseki alusel kasutajale kõigi konstruktsiooni- ja materjalivigade puhul. Garantii seisneb defektsete osade väljavahetamises. See garantii ei kehti aparadi normide ebatavalise eiramise puhul ega ostja poolt keelatud viisil kasutamisest või hooletussejätmisest tulenevate kahjude korral. Garantii ei kehti seadme defektidest põhjustatud kahjude puhul.

IV. GARANTIIJA

Šis prietaisas yra užtikrinamas kaip itin geros kokybės, nuo jo pardavimo datos iki jo panaudojimo, ir jam yra suteikiamas garantinis talonas. Garantijos metu galima pakeisti atsiradusius trumplaikakius gedimus. Ši garantija netaikoma esant netinkamam naudojimui ar nesilaikant

reikiam šio aparato vartojimo instrukciją, tai pat pačiam pirkeėjui jį sugadinus. Garantija taip pat netaikoma, prietaisą naudojant ne pagal paskirtį ir jį apgadinus

IT. GARANTIA

Šim darbarikam ir figumà notielkta garantija visiem defektiem, kas saàstàs ar konstrukciju un materiàlu, sàkòt ar pàrdošanas datumu, kad mašinu pàrdod lietotàjam un vienkàrši uzràdot kases àeku. Garantija iekļauj bojàto daļu nomaiņu. Ši garantija nav derīga, ja aparàts nav lietots saskaņà ar drošības noteikumiem, ne gadījumos ja bojājumi radušies nesankcionētas iejaukšanās gadījumā vai arī pircēja nolaidības dēļ. Garantija nav derīga, ja bojājumi radušies darbarika defekta dēļ

HR. JAMSTVO

Ovaj alat ima ugovorno jamstvo u slucaju bilo kakvih nedostataka u konstrukciji i materijalu, od datuma prodaje korisniku uz jednostavno predocenje racuna. Jamstvo se sastoji u zamjeni neispravnih dijelova. Ovo se jamstvo ne primjenjuje u slucaju uporabe i eksploatacije koja nije sukladna standardima uređaja, niti u slucaju štete uzrokovane neovlaštenim intervencijama ili nemarom kupca. Jamstvo se ne primjenjuje na štetu uzrokovanu nekim nedostatkom alata.

GARANTIE - WARRANTY



FR. GARANTIE

Cet outil est garanti contractuellement contre tout vice de construction et de matière, à compter de la date de vente à l'utilisateur et sur simple présentation du ticket de caisse. La garantie consiste à remplacer les parties défectueuses. Cette garantie n'est pas applicable en cas d'exploitation non conforme aux normes de l'appareil, ni en cas de dommages causés par des interventions non autorisées ou par négligence de la part de l'acheteur. La garantie ne s'applique pas sur les dommages causés par une défaillance de l'outil.

DE. GARANTIE

Die Garantiezeit für dieses Gerät in bezug auf Konstruktions- und Materialfehler beträgt lt. Vertrag bei Vorlage des Kassenbons. Die Garantieleistung besteht im Ersatz schadhafter Teile. Die Garantie erlischt bei einem Einsatz des Geräts, der nicht normentsprechend ist, bei Schäden, die auf unsachgemäße Eingriffe zurückzuführen sind bzw. bei Nachlässigkeit seitens des Käufers. Die Garantie erstreckt sich nicht auf Schäden, die auf Fehlfunktionen des Geräts zurückzuführen sind.

IT. GARANZIA

Quest' attrezzo è garantito per contratto contro qualsiasi difetto di costruzione e di materia, a partire dalla data di vendita all'utente e su semplice presentazione dello scontrino. La garanzia consiste nel sostituire le parti difettose. Questa garanzia non è applicabile in caso di sfruttamento non conforme alle norme dell'apparecchio, né in caso di danni causati da interventi non autorizzati o da negligenza da parte dell'acquirente. La garanzia non si applica ai danni causati da un'avaria dell'attrezzo.

EN. GARANTIE

This tool is guaranteed, in writing, against any defect in manufacture or parts from the date of sale, upon simple presentation of the sales slip. The guarantee is limited to the replacement of faulty parts. This guarantee is not applicable in the event of usage which is not conform with the intended usage of the apparatus, nor in the event of damage caused by unauthorised servicing or negligence on behalf of the purchaser. This guarantee does not apply to any damage caused by the failure of this tool.

ES. GARANTÍA

Esta herramienta se garantiza contractualmente contra todo defecto de construcción y materia, a partir de la fecha de venta a l' usuario y sobre simple presentación del recibo de caja. La garantía consiste en sustituir a las partes defectu-

osas. Esta garantía no es aplicable en caso de explotación no conforme a las normas del aparato, ni en caso de daños causados por intervenciones no autorizadas o por negligencia por parte del comprador. La garantía no se aplica sobre los daños causados por un fallo del herramienta.

NL. GARANTIE

Dit gereedschap heeft een garantie tegen constructiefouten en materiaaldefecten, die geldig is vanaf de aankoopdatum door de gebruiker, op vertoning van de kassabon. De garantie betreft de vervanging van de defecte onderdelen. Deze garantie is niet van toepassing indien het apparaat niet volgens de normen gebruikt is, noch in geval van schade veroorzaakt door oneigenlijk gebruik of nalatigheid van de koper. De garantie is niet van toepassing op schade voortvloeiend uit een defect van het gereedschap.

PT. GARANTIA

Esta ferramenta tem uma garantia contratual contra qualquer defeito de construção e de material, a partir da data de venda ao utilizador e sobre simples apresentação do talão da caixa. A garantia consiste em substituir as partes defeituosas. Esta garantia não é aplicável no caso de exploração não conforme às normas do aparelho, nem em caso de danos causados pelas intervenções não autorizadas ou por negligência da parte do comprador. A garantia não se aplica para os danos causados por uma falha da ferramenta.

EL. ΕΓΓΥΗΜΑ

Το εργαλείο αυτό φέρει συμβατική εγγύηση για οποιδήποτε ελαττωμα κατασκευής από την ημερομηνία Πώλησης στο χρήστη. με απόλυτη Προσέγγιση της απόδοσης αγοράς. Η εγγύηση αποδίδεται από την αντικατάσταση των ελαττωματικών τμημάτων. Η Παρούσα εγγύηση δεν εφαρμόζεται σε περίπτωση χρήσης μη σύμφωνα με τα Πρότυπα της συσκευής, ή σε περίπτωση ζημιάς που προκλήθηκε από μη εγκεκριμένη επεμβάση ή από αμέλεια του αγοραστή. Η εγγύηση δεν εφαρμόζεται στις ζημιές που προκαλούνται από βλάβη του εργαλείου. Στρωμένο κενό Διασπομο-Παρεμβόμα

PL. GWARANCJA

Narz ędzie jest obj ęte gwarancj ą na wszelkie wady konstrukcyjne i materiałowe, licząc od daty sprzedaży u ętkownikowi i po okazaniu paragonu kasowego. Gwarancj ą obejmuje wymian ę cz ęci wybrakowanych. Gwarancj ą nie znajduje zastosowania w przypadku u ętkowania niezgodnego z normami urz ądzenia, ani w przypadku szkód spowodowanych działaniami niedozwolonymi lub zaniedbaniami ze strony nabywcy. Gwarancj ą nie obejmuje szkód powstałych z powodu upadku urz ądzenia.

SV. GARANTI

Detta verktyg har en avtalsenlig garanti mot konstruktions och materialfel, från och med tidpunkten för användarens inköp och genom uppvisning av kassakvittot. Garantin består i att ersätta de bristfäll-

ga delarna. Denna garanti gäller inte om användningen inte motsvarar apparatens standarder, inte heller vid skador som orsakas av ej tillåtna ingrepp eller på grund av köparens vårdslöshet. Garantin gäller inte förskador som orsakats av att verktyget fungerat bristfälligt.

FI. TAKU

Tämän laitteen takuu on voimassa sopimukseenmukaisesti kattaa kaikki rakenne- ja materiaali- ja lukien ostopäivästä kassakuittia vastaan. Takuu sisältää viallisten osien korvaamisen. Takuu ei korvaa ohjeidenvastaista käyttöä eikä valtuuttamattomien henkilöiden käsittelystä tai ostajan huolimattomuudesta aiheutuneita vahinkoja. Takuu ei vastaa myöskään toimintahäiriöistä aiheutuneita vahinkoja.

RU. ГАРАНТИЯ

Этот инструмент е под договорна гаранция срещу всякакъв дефект в изработката и използваните материали, считано от датата на продажба на потребителя и само срещу представяне на касовата бележка. Гаранционното обслужване се състои в замяна на дефектните части. Настоящата гаранция не е валидна когато апаратът се използва по начин, несъответстващ на стандарта за работа с него, както и в случай на щети, нанесени от неоторизирани лица, или вследствие на проявена небрежност от страна потребителя. Гаранцията не покрива щети, произтекли вследствие на техническа неизправност на апарата.

DA. GARANTI

Dette værktøj er dækket af en garantikontrakt for konstruktions- og materialefejl, som gælder fra købsdatoen ved visning af kassebonen. Garantien består i at udskifte de defekte dele. Garantien dækker ikke fejl opstået som følge af anvendelse, som ikke overholder standarderne for apparatet, eller skader opstået ved ikke autoriserede indgreb eller sløsethed fra brugerens side. Garantien dækker ikke skader opstået, fordi værktøjet har svigtet.

Description et repérage des organes de la machine
Description and location of machine parts

A



Contenu du carton
Contents of box

C

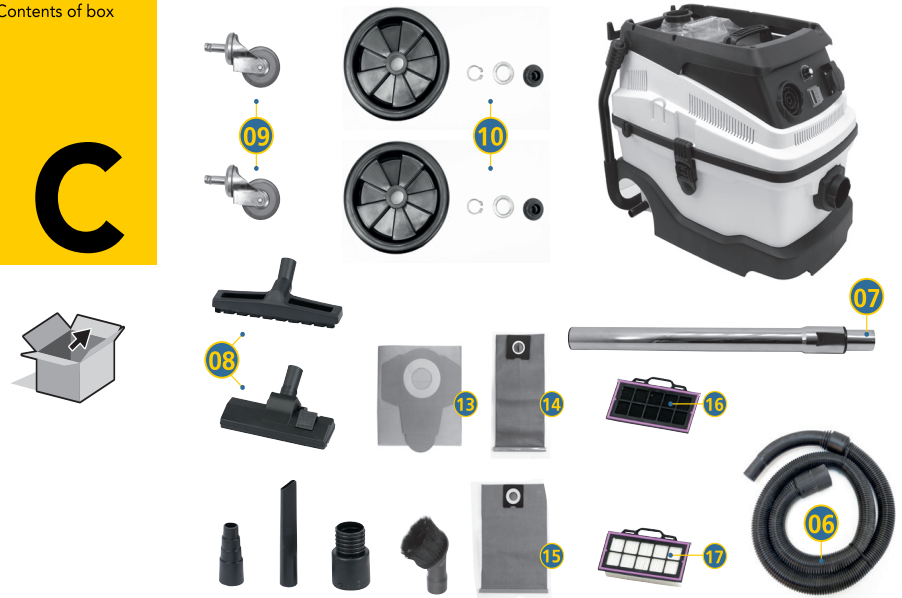

Assemblage de la machine
Assembling the machine

D

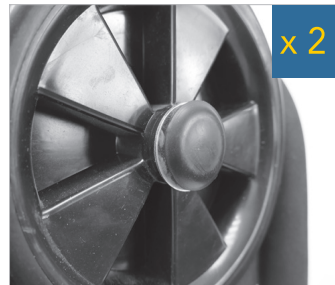
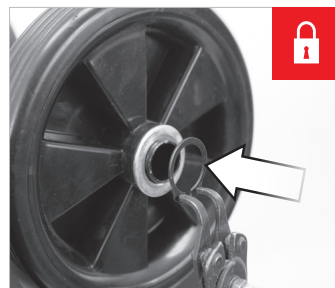
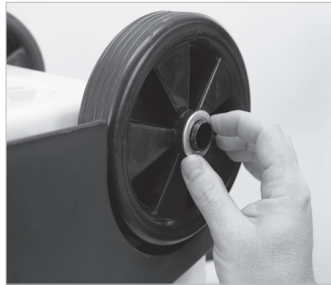
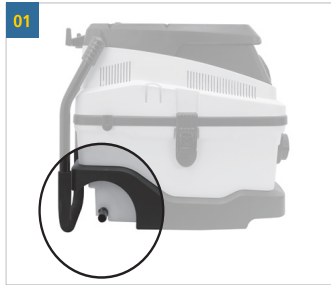

SWEDIC SD-P36L

230V-60Hz 1800 W 18 Kpa 30 L

Total power: 3600 W. Maximum servo power: 2000 W

Swedic Industrial Cleaning
www.swedic.eu

CE



DECLARATION DE CONFORMITE
 VERKLARING VAN OVEREENSTEMMING
 DECLARACION DE CONFORMIDAD
 DICHIARAZIONE DI CONFORMITA
 KONFORMITÄSERKLÄRUNG
 DECLARATION CONFORMITY
 DECLARAÇÃO DE CONFORMIDADE
 DEKLARACJA ZGODNOSCI Z NORMAMI
 OM ÖVERENSSTÄMMELSE
 VAATIMUSTENMUKAISUUSVAKUUTUS
 ÖVERENSSTÄMMELSESEKLERING
 Δήλωση συμμόρφωσης/συμμόρφωσης

DECLARAȚIE DE CONFORMITATE
 VYHLÁSENIE ZHODY
 Декларация соответствия
 הצהרת תואמת
 Uygunluk beyanı
 التصريح بالخطابفة
 PROHLÁŠENÍ SHODY
 EGYZŐSÉGI NYILATKOZAT
 Декларация за съответствие с нормите
 IZJAVA O SKLADNOSTI
 DEKLARACIJA
 ATITIKTIES DEKLARACIJA
 KINNITUS
 IZJAVA O SUKLADNOSTI

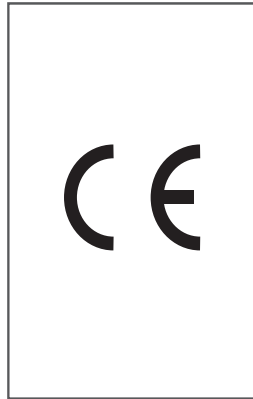

El suscrito,
 Il sottoscritto,
 The undersigned,
 Nijei podpisany
 Allekirjoittanut,
 Ουπτογεγραμμένος
 Nizšie podpísany
 ההחתום
 الحقوقي
 Alulírott,
 Podpisani,
 Apakšā parakstījis
 allakirjutanu
 Dolje potpisani,
 Declara por la presente, que,
 Dichiare che,
 Declares that,
 Oświadczam niniejszym, że
 Ilmoitetaan täten että,
 Δηλώνω με την Παράστα
 týmto vyhlásuju, že
 מצהיר בזה כי
 يصرح استنادا على ذلك
 kijeleńtem, hogy a készülék Izjavlja da,
 Pareiškia, kad,
 Ar šo apliecinā, ka,
 Kinnitab, et
 Izjavljuje u ovom dokumentu da je

Aspirateur à décolmatage / Decluttering vacuum cleaner / Decluttering Staubsauger / Aspiradora desordenada /
 Aspirapolvere di decluttering / Aspirador decluttering / Ophelderende stofzuiger / Ηλεκτρική σκούπα απολύμωσης / Odkurzac do odpryskania /
 Decluttering pólyn imuri / Decluttering vysávač / Прахосмукачка с дефлуинг / Decluurende støvsuger / Aspirator de decluttering / Захламлене пылесоса /
 Decluttering elektrikli süpürge / Decluttajci vysavač / Decluttering vysávač / שאבב אבק התזה / Decluttering porszívó / Decluttering sesalnik /
 Вакуум тоlmинеја / Pramoninis plauamas dulkių siurblys / Вакуум тоlmинеја / Utisni utisavač

Est conforme et satisfait aux directives et normes CE,
 In overeenstemming is met en Voldoet aan EG richtlijnen,
 Den folgenden EU-Bestimmungen entspricht,
 Respeita e está em conformidade com as normas CE,
 Överensstämmer med och uppfyller EG-standarder,
 Съответства и отговаря европейските норми
 Er i overensstemmelse med og overholder EU
 standarderne
 Èste conform și satisface normele CE
 полностью соответствует и удовлетворяет
 требованиям стандартов EC
 CE şartlara uygundur,
 odpovídá normám ES,
 Atitinka ir atitinka EB direktyvas ir standartus,

Cumple con la directivas de la CE,
 E conforme alle direttive CEE,
 Complies with the EEC directives and standards,
 Odpowiada normom UE,
 Täyttää EU-vaatimukset,
 Είναι συμμόρφωνο και ανταποκρίνεται στα Πρωτόκολλα CE
 zodpovedá normám ES,
 מתאים ועונה לתקני CE
 بأن الرجاء يطابق و يلبى مجموعة الدول الأوروبية
 kielégíti a CE szabványok előírásait,
 Je v skladu z in izpolnjuje norme Evropske skupnosti,
 Atbilst un atbilst EK direktīvas un standartus,
 Vastab ja vastab EU direktiividele ja standartiteile,
 Sukladan i ispunjava direktive i standarde CE,

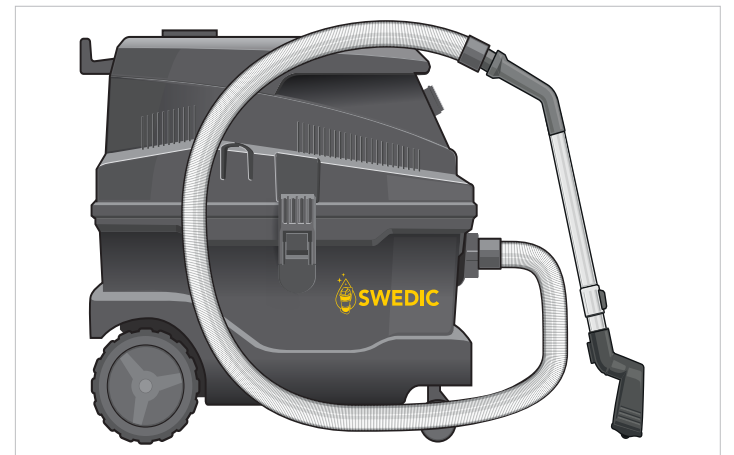

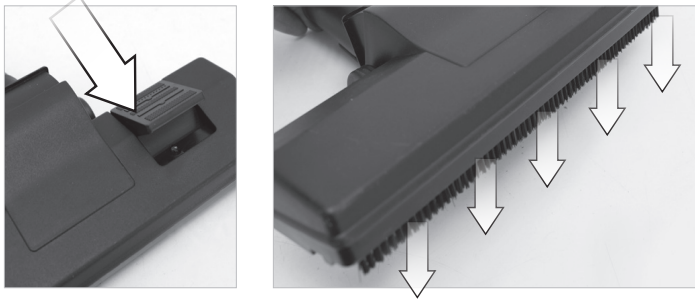
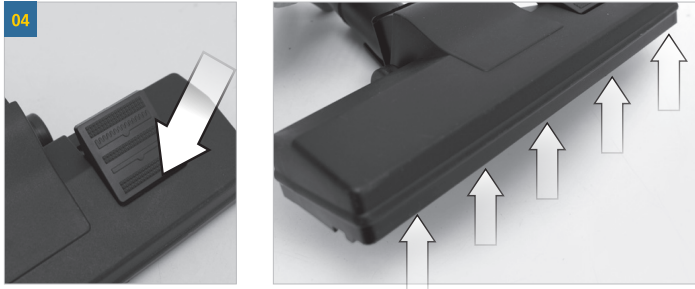

Assemblage de la machine
Assembling the machine

D

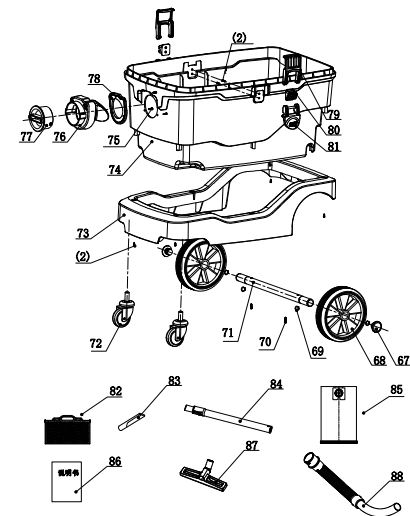
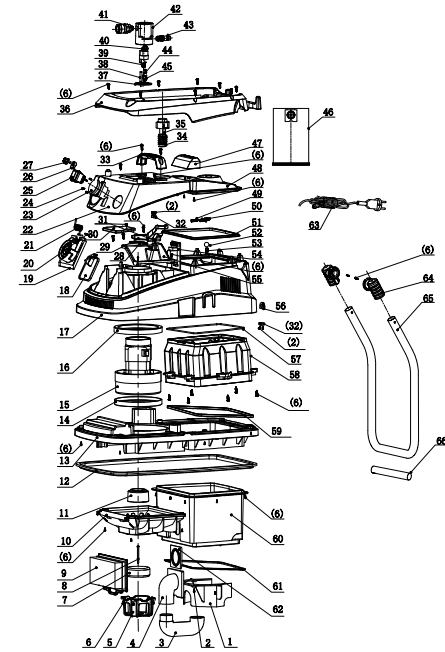

MF 35PLASTER



	Capacité cuve :	beholderkapacitet :	35 L
	Tank capacity:	capacitate cuvă:	
	Volumen der Wanne :	объем бака :	
	Capacidad depósito :	Kap kapacitesi :	
	Capacità vasca :	kapacita nádoby :	
	Capacidade da tina :	obsah nádrže :	
	Capaciteit van de kuip :	מידות סמרות :	
	χωρητικότητα δεξαμενή :	سعة الخزان :	
	Pojemność zbiornika :	a kád kapacitása :	
	Säiliön vetävyys :	kapaciteta kadi :	
Cisternkapacitet:	Капацитет на корпуса :		

	Diamètre tuyau :	rørdiameter :	Ø 35 mm
	Tube diameter:	diametru furtun :	
	Schlauchdurchmesser:	диаметр трубы	
	Diámetro tubo :	Boru çapı :	
	Diametro tubo :	průměr trubky :	
	Diámetro do tubo :	priemer hadice :	
	Diameter van de buis :	קוטר צינור :	
	Διάμετρο σωλήνα :	قطر الأنبوب :	
	Srednica przewodu :	a cső átmérője :	
	Putken halkaisija :	premer cevi :	
Rørdiameter :	Диаметър на тръбата :		

IP X4	X
--------------	----------

Functionalité de la machine
Functions of the machine

E

01  **Aspiration particules fines uniquement (plâtre, béton)**

Nur feine Partikel absaugen (Putz, Beton)
Alleen afzuiging van fijne deeltjes (gips, beton)
Succión solo de partículas finas (yeso, hormigón)
Sucção apenas de partículas finas (gesso, concreto)
Aspirazione solo di particelle fini (intonaco, calcestruzzo)
Suction of fine particles only (plaster, concrete)

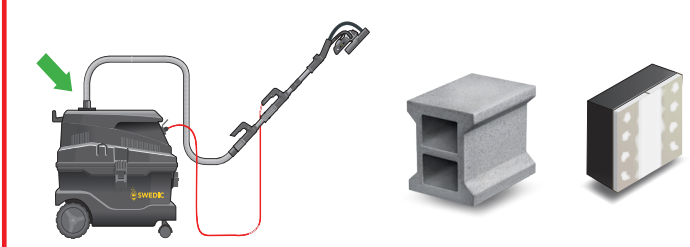

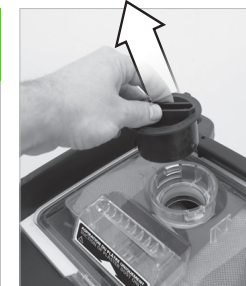

11

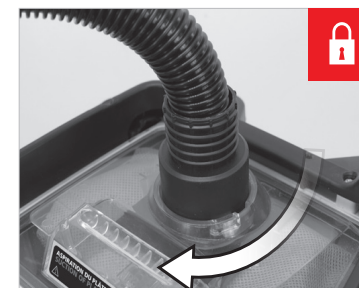
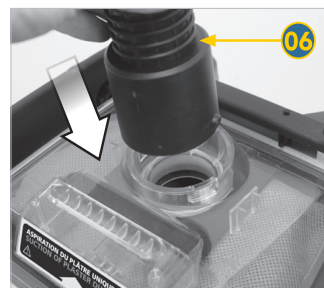

06

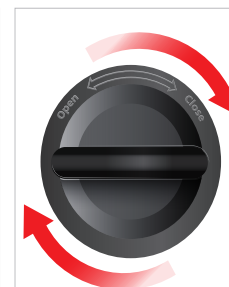

11



Aspiration particules fines uniquement (plâtre, béton)
 Nur feine Partikel absaugen (Putz, Beton)
 Alleen afzuigen van fijne deeltjes (gips, beton)
 Succión solo de partículas finas (yeso, hormigón)
 Sucção apenas de partículas finas (gesso, concreto)
 Aspirazione solo di particelle fini (intonaco, calcestruzzo)
 Suction of fine particles only (plaster, concrete)

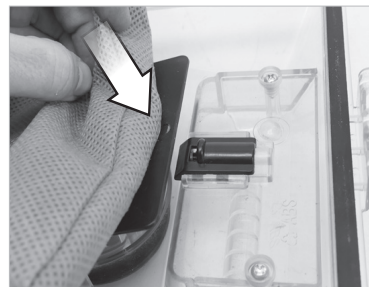
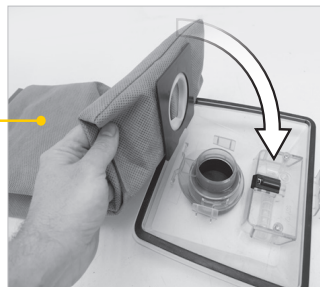
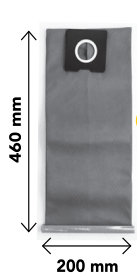
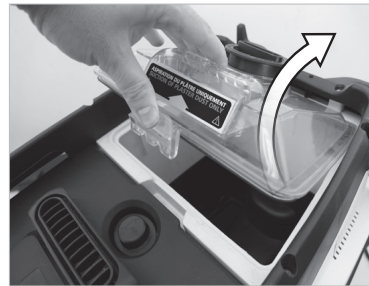

Ref. 101859



	Lire les instructions avant usage : Read the instructions before use : Vor Einsatz des Geräts Anweisung lesen : Léase las instrucciones antes de usar : Leggere le istruzioni prima dell'uso : Ler as instruções antes da utilização : Lees voor het gebruik de instructies : Διαβάστε τις οδηγίες χρήσης : Zapoznać się instrukcją przed użyciem : Lue ohjeet ennen käyttöä : Läs anvisningarna före användning : Læs instruktionerne før brug : Înainte de utilizare, citiți instrucțiunile :	Внимательно прочитайте следующие инструкции : Kullanmadan talimatları okuyunuz : Pozorně si přečtěte následující pokyny : Pred použitím si prečítajte pokyny : זרם הילופי اقرأ التوجيهات قبل الاستخدام. használat előtt olvassuk el az utasítást : Pred uporabo preberite ustrezna navodila Прочетете указанията за употреба : Enne kasutamist lugege instruksiooni Prieš naudojimą perskaityti instrukciją izlasīt instrukcijas pirms lietošanas Pročitati upute prije uporabe:	X

	Danger : Danger : Gefahr : Peligro : Pericolo : Perigo : Gevaar : Κινδύνος : Niebezpieczeństwo : Vaara : Fara : Fare : Pericol :	Onačno : Tehlike : Nebezpečí : Nebezpečnostvo : סכנה, خطر. Veszély : Nevarnost : Опасност : Oht Pavojus Bistamība Опасност:	X

	Soumis à recyclage Subjected to recycling Sujeto a reciclaje Sottoposti a riciclaggio Sujeitos à reciclagem Não deite no lixo : Niet wegwerpen : Μην την πετάτε : Nie wyrzucać : Älä heittää pois luontoon : Batteriet får inte kastas : Bortkast det ikke : Nu le auncati :	Не выбрасывайте в мусорный ящик Atmayınız : Nevyhazujte je do bežného odpadu : Neodhadzovat : אין לזרוק סוללות فلا ترممها لهذا في القمامة. ne mečíte! Ne odvržite ga/jih vstran : Не го изхвърляйте : Ärge visake seda minema : Nemétykíte : Nemest : Podvrgnuto recikliranju	X

Recyclage des déchets
 Les outils, accessoires et leur emballages doivent suivre une voie de recyclage adaptée. Conformément aux directives Européenne 2012/19/UE et 2006/66/CE, les composants d'un produit doivent être séparés, collectés, recyclés ou éliminés en conformité avec les réglementations environnementales en vigueur. Les appareils, batteries, piles, huiles, emballages devront être déposés dans les systèmes d'élimination des déchets spéciaux tels que déchetteries. Renseignez-vous auprès de votre commune pour connaître l'organisme le plus proche à même de retraiter ou de collecter ces déchets.

	Recyclable, soumis au tri sélectif Recyclable, subject to recycling Recyclingförmige, unterliegen Recycling Reciclables, sujetos a reciclaje Riciclabili, soggetti a riciclaggio Recicláveis, sujeito à reciclagem Recycleerbare, onderworpen aan recycling Ανακυκλώσιμες συσκευασίες που υπόκεινται σε κύκλωση Opakowanie nadaje się do recyklingu podlegają recyklingu Kierrätettävien pakkausten kohteena kierrätys Återvinningsbara förpackningar omfattas återvinning Рециклиращи се опаковки подлежат на рециклиране Genanvendelig underlagt genbrug	Reciclable sub rezerva reciclare Повторно упаковка подлежит вторичной переработке Geri dönüştürülebilir ambalaj konusu Recyclovatelné podléhající recyklaci Recyclovatelné podliehajúce recyklácii רוחמל הירחמל אשונ ریودنلا قایل یخریج ریودنلا قایل قایل یخریج قایل قایل یخریج Újrahasznosítható csomagolás alá újrahasznosítás Reciklirati predmet recikliranje Pakendite suhtes ringlusse võetu Pärsträdjams iepakojums otrrežizai pārstrādei Perdīrbamų taikomos perdirbimo Može se reciklirati, podložno selektivnomu sortiranju	X

	Porter des lunettes de sécurité : Wear protective eyewear : Schutzbrille tragen : Llevar puestas gafas protectoras : Portare de gli occhiali di sicurezza : Utilizar óculos de segurança : Draag een veiligheidsbril : Φορέστε Προστατευτικά γυαλιά : Zakładać okulary ochronne : Käytä suojalaseja : Använd skyddsglasögon : Der skal benyttes sikkerhedsbriller Purtati ochelari de protecție :	Наденьте защитные очки: Güvenlik gözlükleri takın : Používejte bezpečnostní brýle : Noste ochranné okuliare : תוסיפו יפקשמ ביכרהל אנ چهل نظارات وقاية. Viseljen védőszemüveget : Nositi zaščitna očala : Да се използват защитни очила : Kandke kaitseprille Nešioti apsauginius akinius Valkät aizsargbrilles Nositi zaštitne naočale:	X
---	---	---	---

	Porter un masque anti-poussière : Wear a dust mask : Staubschutzmaske tragen : Llevar puesta una careta de protección contra el polvo : Indossare una mascherina anti-polvere : Utilizar uma máscara anti-poeira : Draag een stofmasker : χρήση προστατευτική μάσκα : Zakładać maskę przeciwpyłową Käytä pölysuojust : Bär mask mot damm : Der skal benyttes beskyttelsesmaske mod støv Purtati mască anti-praf :	Наденьте респиратор: Toza karşı maske takın : Používejte masku proti prachu : Noste ochrannú masku proti prachu קבא דגן הכסמ שובהל אנ لیس قناع خضاض للرباب. Viseljen porvédő maszkot Nositi zaščitno masko proti prahu: Да се използва защитна маска : Kandke tolumaski. Dėvėti respiratorių Valkät aizsargmasku pret putekļiem Nositi masku za zaštitu od prašine:	X
---	---	---	---

	Porter une protection auditive : Wear hearing protective equipment: Gehörschutz tragen: Llevar puesta una protección auditiva: Portare una protezione uditiva: Utilizar uma protecção auditiva: Draag gehoorbeschermers: Φορέστε Προστατευτικά ακουστικά Zakładać słuchawki ochronne Käytä kuulosuojaimia: Bär hörselskydd: Der skal benyttes hørevern Purtati căști de protecție auz:	наденьте средства звуковой защиты İşitsel koruma aleti takın: Používejte ochranu sluchu: Noste ochranné slúchadlá: יש ל הרכיב הגנת שמיעה لیس خبوة خضاض الضرجیج Viseljen fülvédőt Nositi zašito ušes Да се използва слухови защитни средства Kandke kõrvakaitset Nešioti apsaugā nuo triukšmo Valkät dzirdes aizsarglīdzekli Nositi štitnike protiv buke:	X
---	--	--	---

	Porter des gants : Use rubber gloves : Schutzhandschuhe tragen : Llevar guantes de protección : Indossare i guanti di protezione : Utilizar luvas de protecção : Draag veiligheidshandschoenen : χρήση προστατευτικών γαντιών : Używać rękawic ochronnych : Käytä suojakäsineitä : Använd skyddshandskar : Der skal benyttes handsker Purtati mănuși :	Наденьте перчатки: Eldiven takın : Noste rukavice : Noste rukavice : תופכ שובלל אנ لیس قفازات. Viseljen kesztyű t Nositi rokavice а се използват предпазни ръкавици : Kandke kindaid Mūvēti pirštines Valkät cimdus Nositi zaštitne rukavice:	X
---	--	---	---

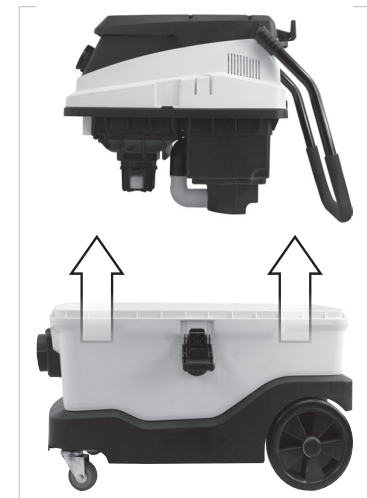
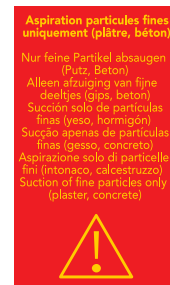

Aspiration particules fines uniquement (plâtre, béton)
 Nur feine Partikel absaugen (Putz, Beton)
 Alleen afzuiging van fijne deeltjes (gips, beton)
 Succión solo de partículas finas (yeso, hormigón)
 Sucção apenas de partículas finas (gesso, concreto)
 Aspirazione solo di particelle fini (intonaco, calcestruzzo)
 Suction of fine particles only (plaster, concrete)



05

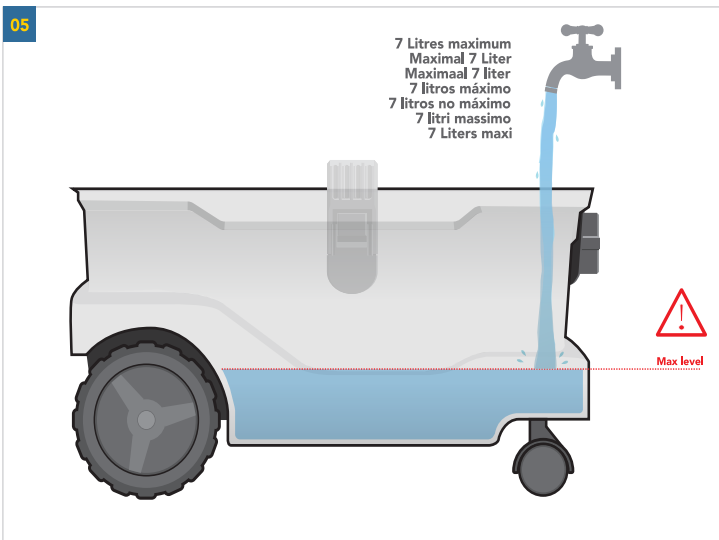

7 Litres maximum
 Maximal 7 Liter
 Maximal 7 liter
 7 litros máximo
 7 litros no máximo
 7 litri massimo
 7 Liters maxi



Max level

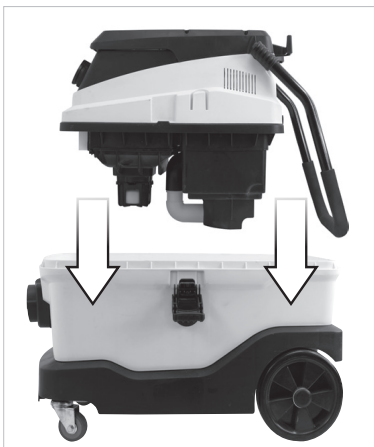
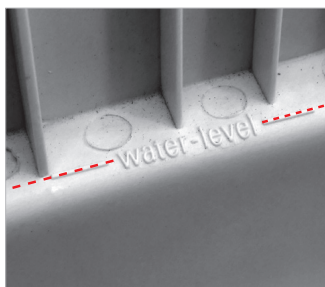
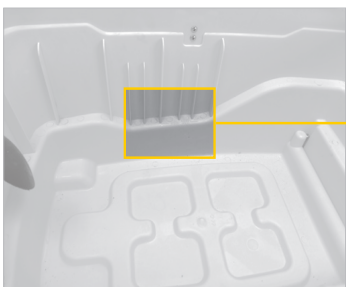

Mettre en place le tuyau coudé et son support pour l'usage d'une aspiration multifiltre. (particules fines : plâtre, béton, ...)

Das Winkelrohr und seine Halterung für die Verwendung eines Mehrfilter-Saugers montieren. (feine Partikel: Gips, Beton, ...)

Monteer de kniestuk en de steun voor het gebruik van een multi-filteraanzuiging. (fijne deeltjes: gips, beton, ...)

Montar el tubo acodado y su soporte para el uso de una aspiración multifiltro. (partículas finas: yeso, hormigón, ...)

Monte o tubo em cotovelo e seu suporte para a utilização de uma sucção multifiltro. (partículas finas: gesso, concreto, ...)

Montare il tubo a gomito e il suo supporto per l'utilizzo di un'aspirazione multifiltro. (particelle fini: intonaco, cemento, ...)

Remove this part for dust extraction only

	Tension et fréquence assignée: Nominal frequency and power: Spannung und Frequenz: Tensión y frecuencia fijada: Tensione e frequenza assegnata: Tensão e frequência fixa: Aangewezen spanning en frequentie: Ονομαστική τάση και συχνότητα: Napięcie i częstotliwość przydzielona: Jännite ja määrittäty taajuus: Angiven spänning och frekvens: Anført spænding og frekvens: Tensiune și frecvență de lucru:	Заданное напряжение и частота: Tahsis gerilimi ve frekans: Spannung napřetí a frekvence: Stanovené napätie a frekvencia: מתח ותדר מוקצב. الغاطية والذبذبة المبرمجة. Névelges feszültség és frekvencia: Napetost in določena frekvencia: Консумирана напрежение и честота: Määratud pinge ja sagedus Nustatyta įtampa ir dažnis Noteiktais spriegums un frekvence. Napon i nazivna frekvencija:	230 V ~ 60 Hz

	Puissance assignée: Nominal power: Leerlaufdrehzahl: Potencia fijada: Potenza assegnata: Potência assinada: Onbelast toerental: Ονομαστική η ισχύς : Prędkość na biegu jałowym: Teho: Angiven effekt: Anført styrke Putere de lucru:	Заданная мощность: Tahsis edilen güç: Stanovený příkon: Predpísaný výkon: כוח מוקצב. القدرة المبرمجة. Névelges teljesítmény : Določena jakost: Консумирана мощност: Määratud võimsus. Nustatyta galia Noteiktā jauda Nazivna snaga:	1800 W

	Poids : Weight : Gewicht : Peso : Peso : Peso : Gewicht : Βάρος : Masa : Paino : Vikt : Vægt : Greutate :	Бec : Ağırlık : Hmotnost : Hmotnosť : משקל الوزن. Súly : Teža : Термо : Raskus Svoris Svars Težina:	16.5 kg

		10-20 kPa
---	--	-----------

	Conformité européenne Conforms to EC standards CE-Konformität Cumple con las directivas CE Conforme alle norme CE Conforme às normas CE Voldoet aan de EG-normen Συμφωσιο με τα πρότυπα Zgodność z normami CE : EU-standardien mukainen : EU-standardien mukainen : Overholder EU standarderne Conform cu normele europene:	соответствие европейским стандартам Avrupa uygunluk : evropská shoda : európska dohoda : התאמה לתקנים האירופיים مطابق للمواصفات الأوروبية. evropska ustreznost : európai megfeleléség : Съответствие с европейските норми Euroopa Liidu vastavusmärk Euroopiņu normų atitikimas Atbilstība Eiropas standartiem Europska sukladnost	X

Entretien
Cleaning

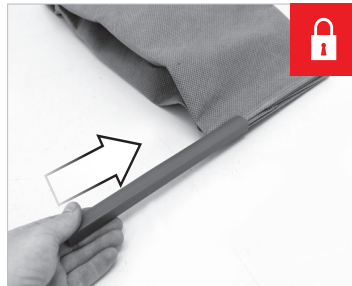
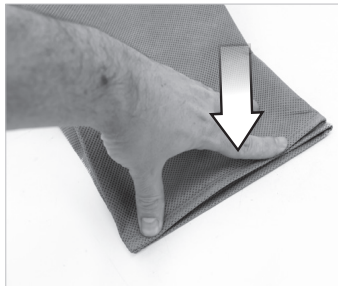
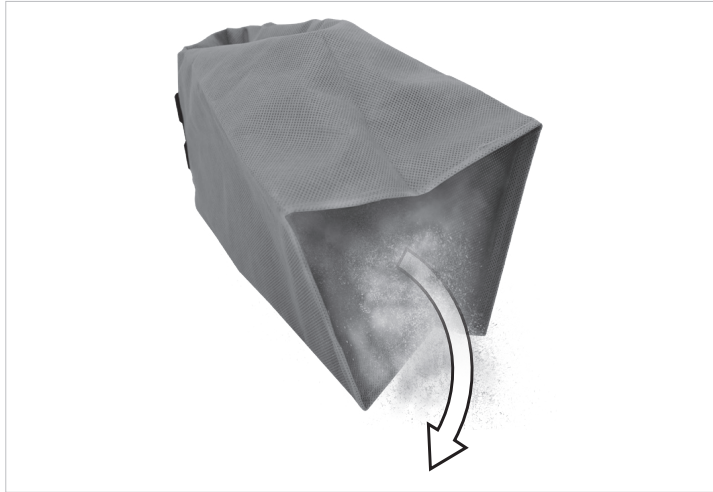
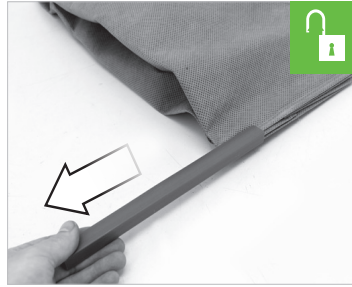
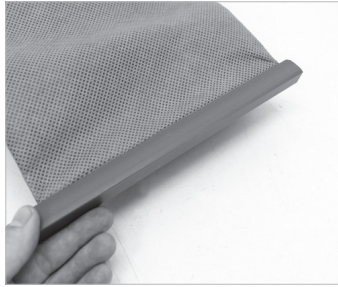

Ref. 101857

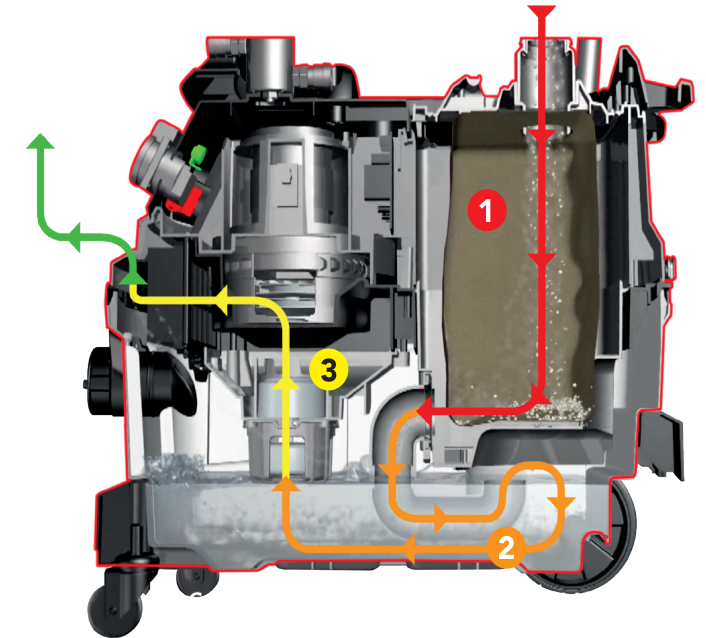
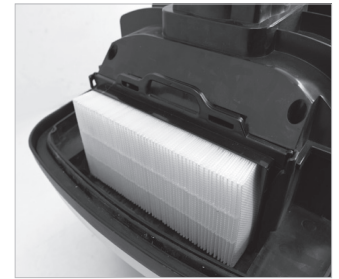

1 1er niveau de filtration : sac à poussières :
Retire les particules fines (PM 2,5)
1st filtration level: dust bag:
Removes fine particles (PM 2.5)

2 2ème niveau : bac à eau :
Retire les particules très fines (PM 1,0)
2nd level: water tank:
Removes fine particles (PM 1.0)

3 3ème niveau : Filtre HEPA
Retire les particules ultrafines (PM 0,1)
3rd level: HEPA filter
Removes ultrafine particles (PM 0.1)

Aspiration particules fines uniquement (plâtre, béton)
 Nur feine Partikel absaugen (Putz, Beton)
 Alleen afzuiging van fijne deeltjes (gips, beton)
 Succión solo de partículas finas (yeso, hormigón)
 Sucção apenas de partículas finas (gesso, concreto)
 Aspirazione solo di particelle fini (intonaco, calcestruzzo)
 Suction of fine particles only (plaster, concrete)

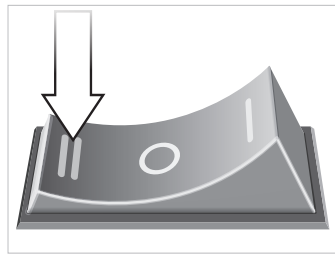
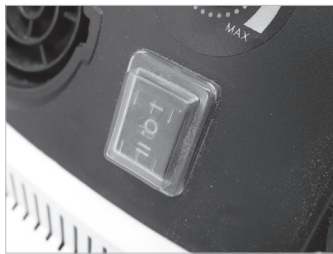
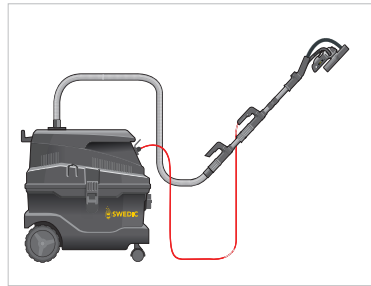
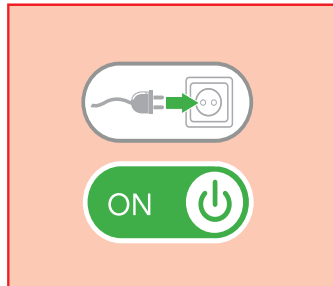
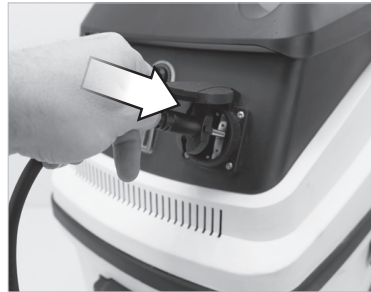
2000 W MAX



**Entretien
Cleaning**

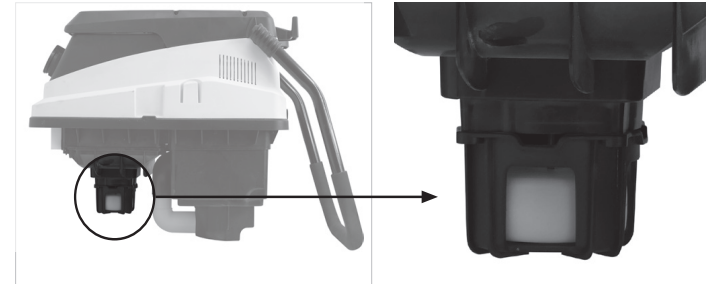

Toujours veiller à ce que le flotteur soit «libre» et ne soit pas gêné par des détritrus (feuilles, gravats) afin de pouvoir remplir sa fonction
 Stellen Sie immer sicher, dass der Schwimmer «frei» ist und nicht durch Ablagerungen (Blätter, Schutt) behindert wird, um seine Funktion erfüllen zu können.
 Zorg er altijd voor dat de vlotter «vrij» is en niet gehinderd wordt door afval (bladeren, puin) om zijn functie te kunnen vervullen.
 Asegúrese siempre de que el flotador esté «libre» y no esté obstaculizado por detritus (hojas, escombros) para poder cumplir su función.
 Certifique-se sempre de que o flutuador está «livre» e não está atropalhado por detritus (folhas, entulho) para poder cumprir a sua função.
 Assicurarsi sempre che il galleggiante sia «libero» e non sia intralciato da detriti (foglie, pietrisco) per poter svolgere la sua funzione.
 Always ensure that the float is «free» and is not hampered by detritus (leaves, rubble) in order to be able to fulfill its function.

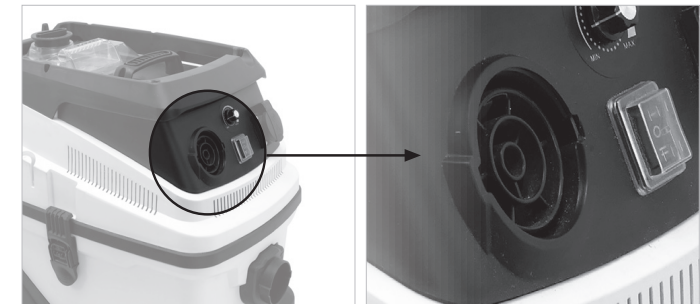

Remplacement des consommables
Consumables replacing

G

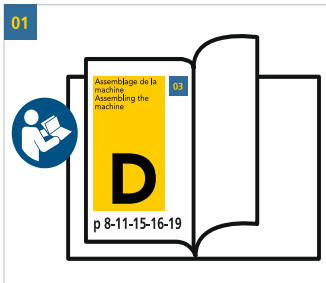

Option- Option - Option - Opcional - Opzione - Opção - Opție - Επιλογή - Opcja - Valinnainen - Tillval - Дополнително - Ekstra udstyr - Opfiene - Оптация - seçenek / seçim - Volba - Volba - מוצגים / מצגות - Opcija - Izvēle

101856 :

Filtere cartouche mousse pour eaux
Schuimpatroonfilter voor water
Filtro de cartucho de espuma para agua
Filtro de cartucho de espuma Para água
Filtro a cartuccia in schiuma per l'acqua
Foam cartridge filter for water



101857 :

Filtere cartouche papier pour poussières
Papieren patroonfilter voor stof
Filtro de cartucho de papel para el polvo
Filtro de cartucho de papel para poeira
Filtro a cartuccia di carta per la polvere
Paper cartridge filter for dust



101858 :

Sac toile pour cuve
Stofzak
Bolsa de polvo
Saco de pó
Borsa antipolvere
Dust bag

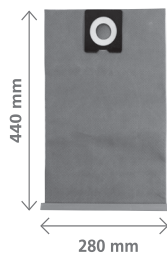

101859 :

Sac à poussières Spécial particules fines
Speciale stofzak
fijne deeltjes
Bolsa de polvo especial partículas finas
Saco de pó especial partículas finas
Sacco polvere speciale particelle fini
Special dust bag
fine particles

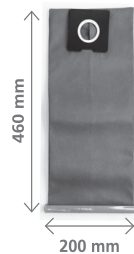

Fonctionnalité de la machine
Functions of the machine

E

08

Aspiration eau et poussières uniquement
Wasserabsaugung und nur Staub
Waterafzuiging en alleen stof
Aspiración de agua y solo polvo
Sucção de água e somente poeira
Aspirazione dell'acqua e solo polvere
Water suction and dust only

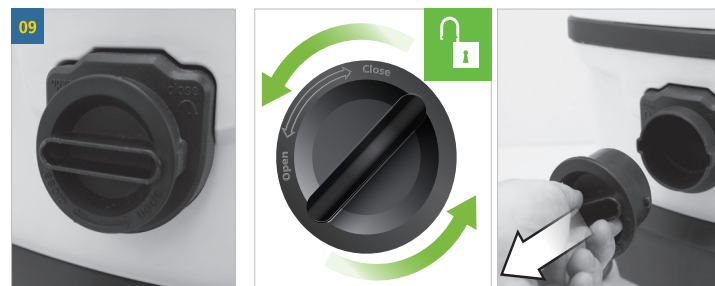

Poussières uniquement
 Staub
 alleen stof
 solo polvo
 somente poeira
 solo polvere
 dust only

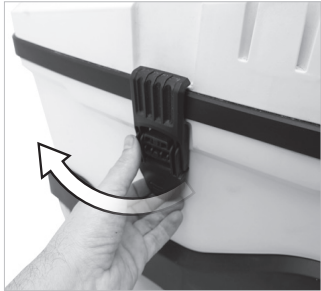

Avant d'installer le sac à poussières, s'assurer qu'il ne reste pas d'eau dans le fond du bac de l'aspirateur !
Stellen Sie vor dem Einsetzen des Staubbeutel sicher, dass sich kein Wasser mehr im Boden des Staubsaugers befindet!
Zorg ervoor dat er geen water op de bodem van de stofzuiger zit voordat u de stofzak installeert!
Antes de instalar la bolsa para el polvo, asegúrese de que no quede agua en el fondo de la aspiradora.
Antes de instalar o saco de pó, certifique-se de que não há água no fundo do aspirador!
Prima di installare il sacchetto per la polvere, assicurarsi che non sia rimasta acqua sul fondo dell'aspirapolvere!
Before installing the dust bag, make sure there is no water left in the bottom of the vacuum cleaner!

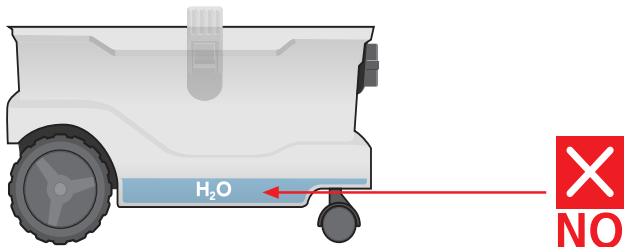

Fonctionnalité de la machine
Functions of the machine

E

Fonction souffleur
 Gebläsefunktion
 Blower functie
 Función de soplador
 Função de soprador
 Funzione ventilatore
 Blower function

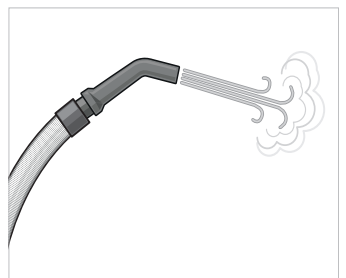
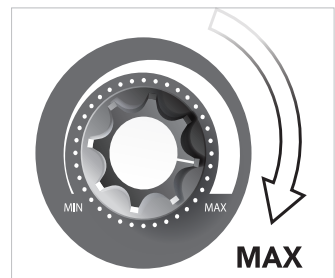
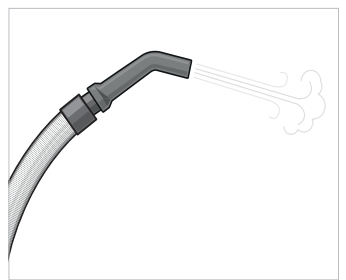
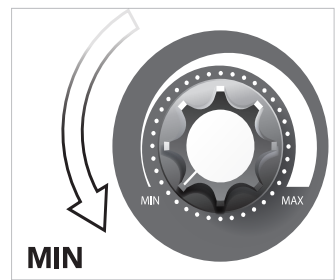
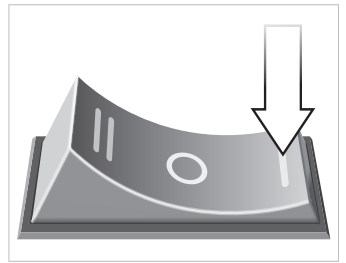

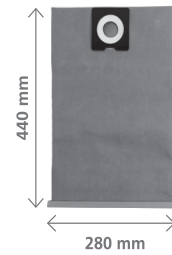
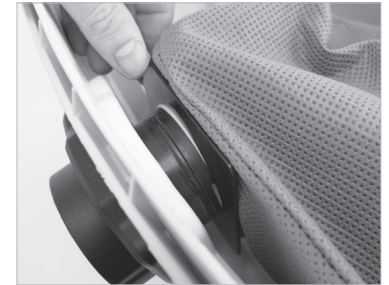
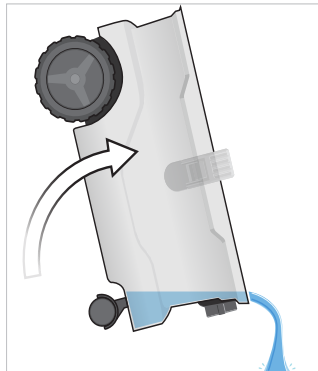

Ref. 101858

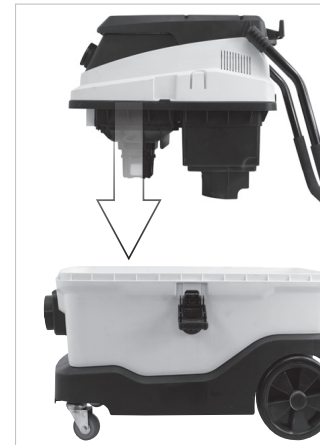
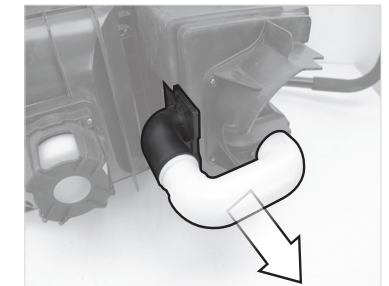
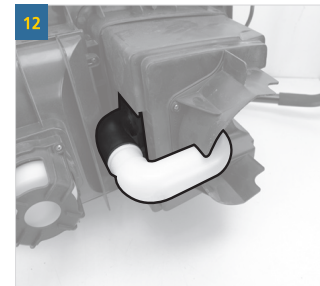
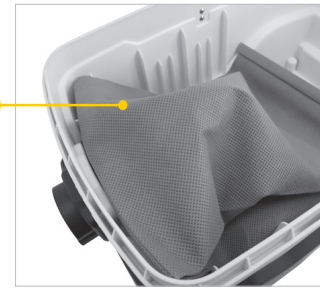

Retirer le tuyau coudé et son support pour l'usage du sac à poussières dans la cuve !

Entfernen Sie das Krümmerrohr und seine Halterung aus dem Staubbeutel im Tank!
Haal het kniestuk en zijn steun voor gebruik uit de stofzak in de tank!
¡Retire el tubo acodado y su soporte para su uso de la bolsa de polvo en el tanque!
Remove o cotovelo e seu suporte para usar o saco de pó no tanque!
Rimuovere il tubo a gomito e il suo supporto per l'uso dal sacchetto per la polvere nel serbatoio!
Remove the elbow pipe and its support for use from the dust bag in the tank!



Ref. 101857

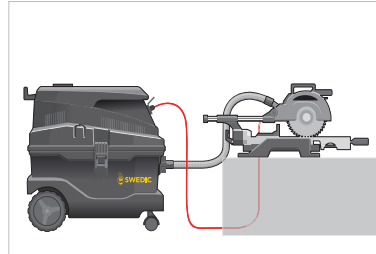
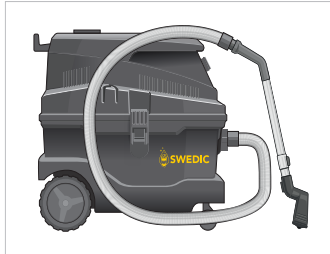

Fonctionnalité de la machine
Functions of the machine

E

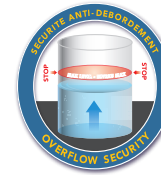

Attention ! lorsque le flotteur atteint le haut, le bruit du moteur augmente fortement mais celui-ci ne s'arrête pas ! Il est recommandé de stopper l'aspirateur immédiatement et de procéder à la vidange de la cuve !

Kijk Uit! wanneer de vlotter voor de top bereikt, motorgeluid sterk toeneemt, maar dit houdt niet op! Het wordt aanbevolen om onmiddellijk te stoppen stofzuigen en ga verder met de tank af te tappen!

Cuidado! cuando el flotador llega a la cima, el ruido del motor aumenta bruscamente, pero esto no se detiene! Se recomienda dejar pasar la aspiradora inmediatamente y proceder a drenar el tanque!

Cuidado! quando o flutuador atinge o topo, o ruído do motor aumenta acentuadamente, mas isso não para! Reco menda-se a interromper a aspiração imediatamente e prosseguir para drenar o tanque!

Attento! quando il galleggiante raggiunge la parte superiore, il rumore del motore aumenta bruscamente, ma questo non si ferma! Si raccomanda di interrompere l'aspirazione immediatamente e procedere svuotare il serbatoio!

Watch Out! when the float reaches the top, engine noise increases sharply but this does not stop! It is recommended to stop vacuuming immediately and proceed to drain the tank!

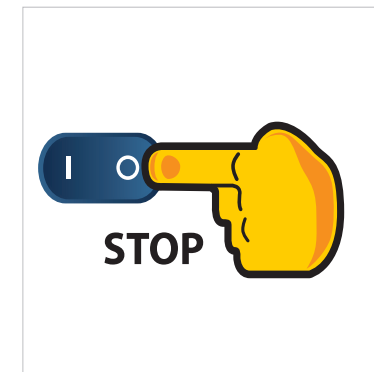
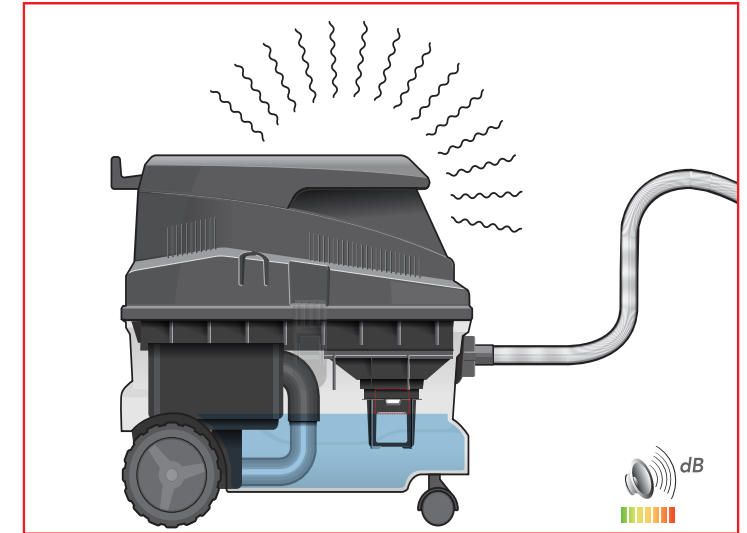

Fonctionnalité de la machine
Functions of the machine

E

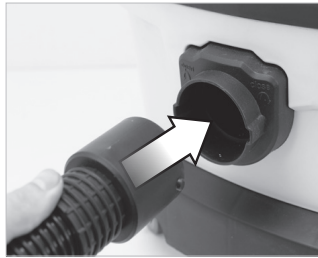

- A** Bouchon flotteur
Vlotter stopper
Float stopper
Tapon del flotador
Float rolha
Float stopper
- B** Entrée d'air - accès au filtre
Luchtinlaat - toegang filter
Entrada de aire - acceso al filtro
Entrada de ar - de acesso ao filtro
Air inlet - filter access

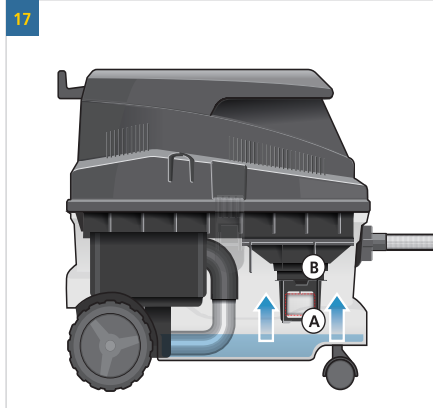

Mettre en place le tuyau coudé et son support pour l'usage d'une aspiration multi-filtre. (particules fines : plâtre, béton, ...)

Das Winkelrohr und seine Halterung für die Verwendung eines Mehrfilter-Saugers montieren. (feine Partikel: Gips, Beton, ...)

Monteer de kniestuk en de steun voor het gebruik van een multi-filteraanzuiging. (fijne deeltjes: gips, beton, ...)

Montar el tubo acodado y su soporte para el uso de una aspiración multifiltro. (partículas finas: yeso, hormigón, ...)

Monte o tubo em cotovelo e seu suporte para a utilização de uma sucção multifiltro. (partículas finas: gesso, concreto, ...)

Montare il tubo a gomito e il suo supporto per l'utilizzo di un'aspirazione multifiltro. (particelle fini: intonaco, cemento, ...)

Remove this part for dust extraction only

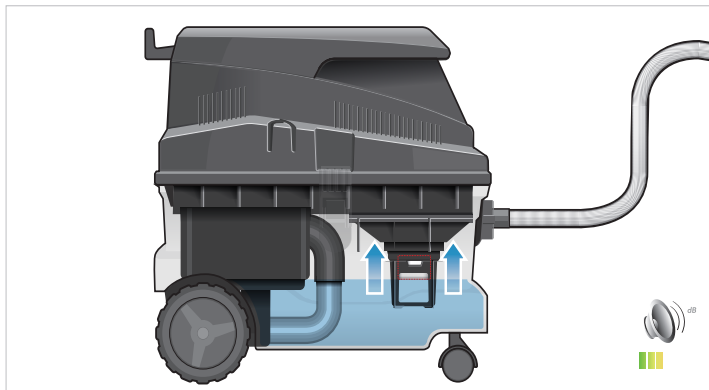

Fonctionnalité de la machine
Functions of the machine

E

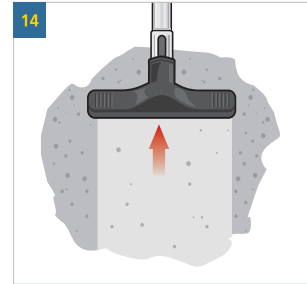

5 s

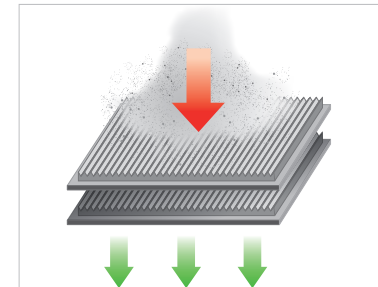

Fonctionnalité de la machine
Functions of the machine

E

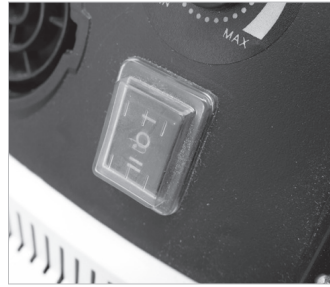
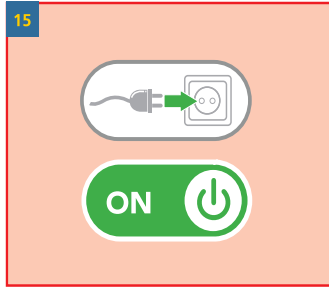

Démarrage instantané
Sofortiger Start
Onmiddellijke start
Inicio instantáneo
Desligamento atrasado
Inizio istantaneo
Instant start

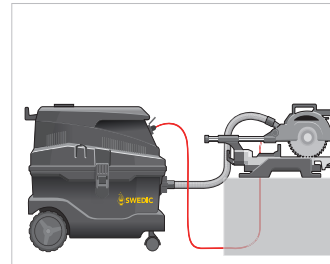
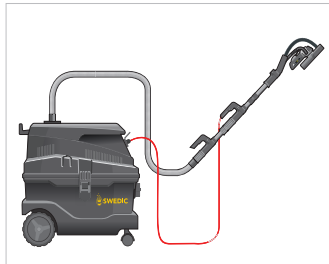
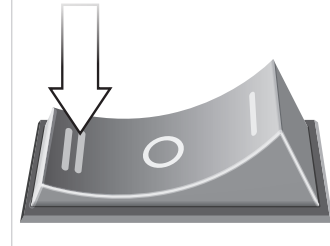
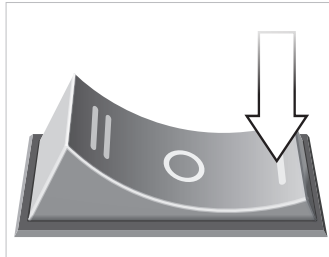

**2000 W
MAX**

Démarrage instantané
Arrêt différé en 10 secondes
Onmiddellijke start
Vertraagde uitschakeling
in 10 seconden
Inicio instantáneo
Apagado retrasado en 10 segundos
Desligamento atrasado
em 10 segundos
Inizio istantaneo
Arresto ritardato in 10 secondi
Instant start
Delayed shutdown in 10 seconds

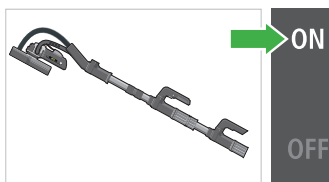

Fonctionnalité de la machine
Functions of the machine

E

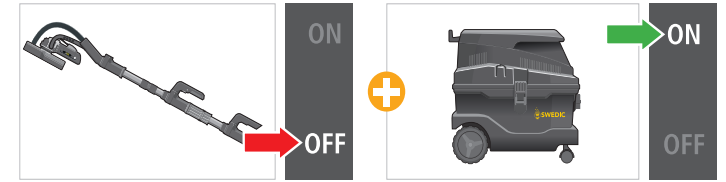

Arrêt différé en 10 secondes
Vertraagde uitschakeling in 10 seconden
Apagado retrasado en 10 segundos
Desligamento atrasado em 10 segundos
Arresto ritardato in 10 secondi
Delayed shutdown in 10 seconds

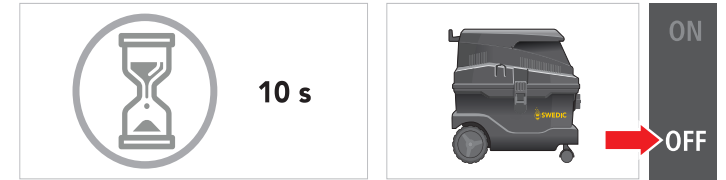

eau uniquement
Wasserabsaugung
Waterafzuiging
água
acqua
Water only

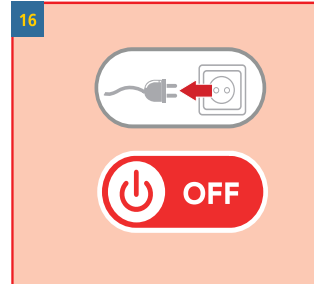

Ref. 101856

