

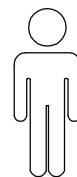

25'

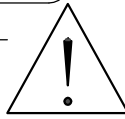

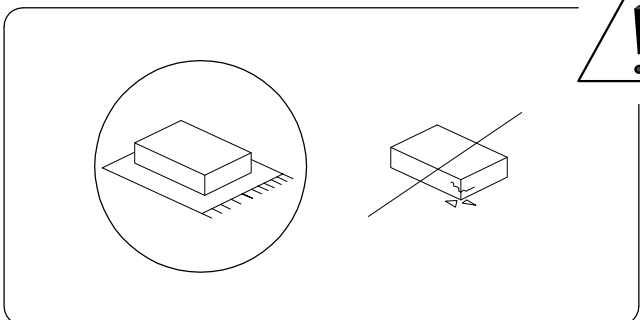

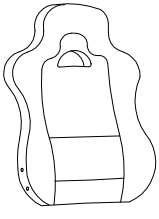
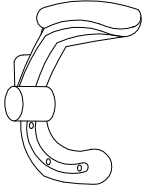

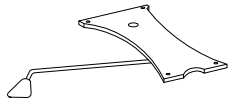

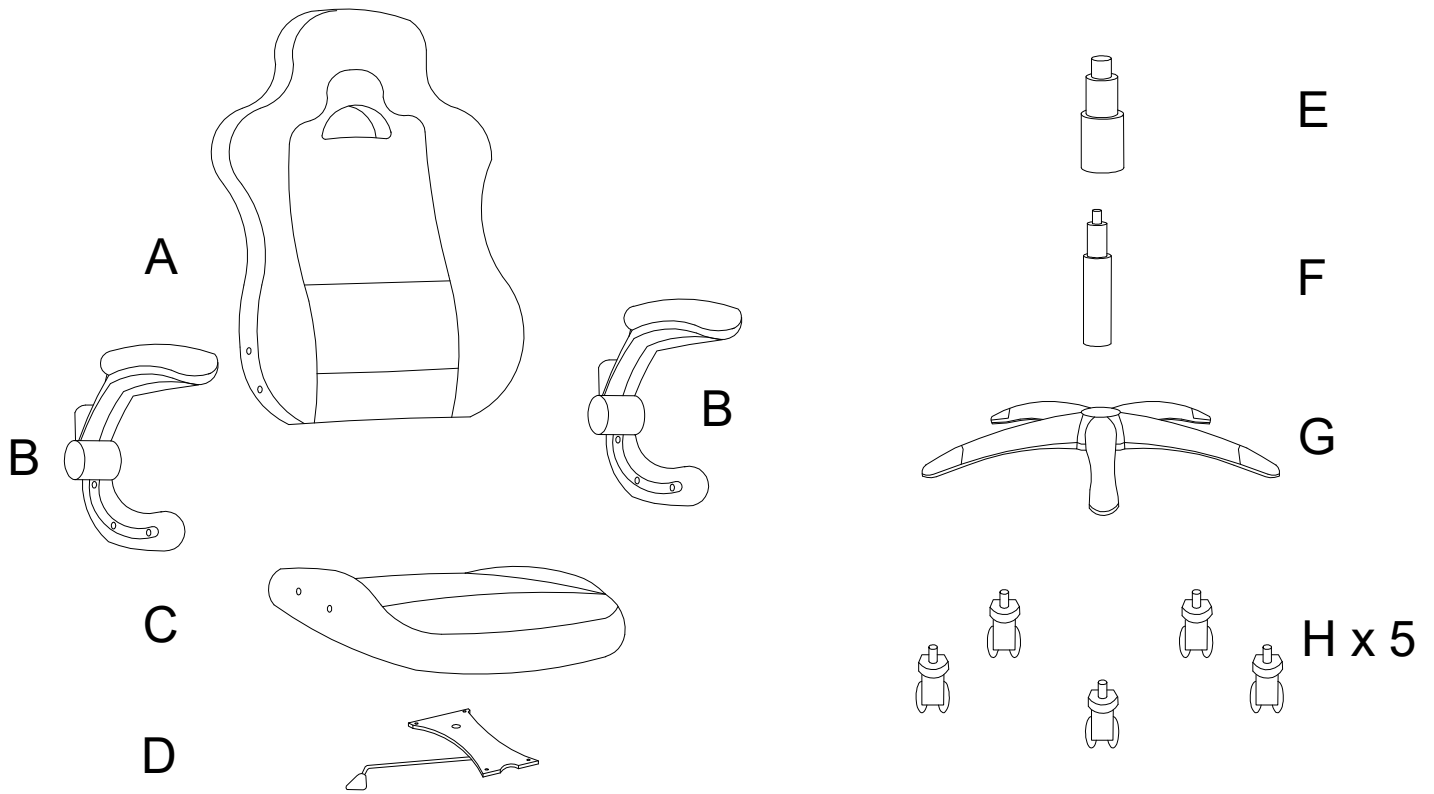
1

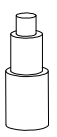
1/4

<b>A</b>  <b>x 1</b>	<b>B</b>  <b>x 2</b>	<b>C</b>  <b>x 1</b>	<b>D</b>  <b>x 1</b>
---	---	--	---

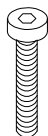

<b>E</b>  <b>x 1</b>	<b>F</b>  <b>x 1</b>	<b>G</b>  <b>x 1</b>	<b>H</b>  <b>x 5</b>
<b>I</b>  <b>x 8</b>	<b>J</b>  M8 x 30 <b>x 8</b>	<b>K</b>  M6 x 20 <b>x 4</b>	<b>L</b>  <b>x 1</b>



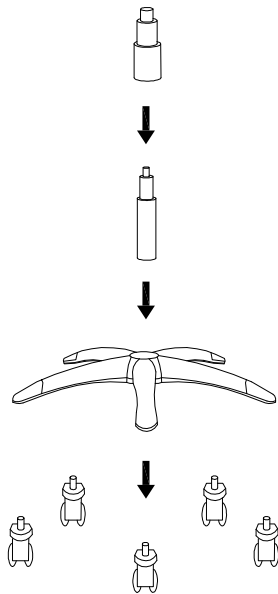
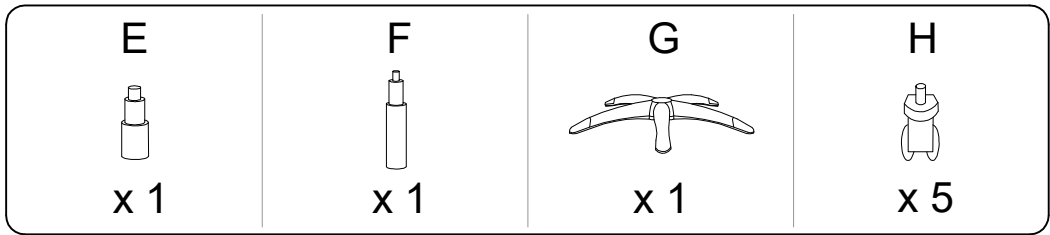

1

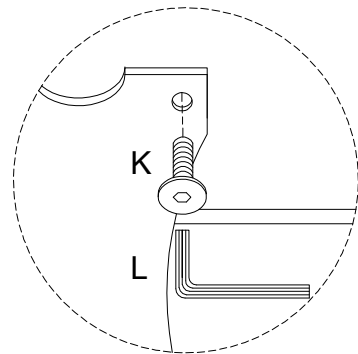
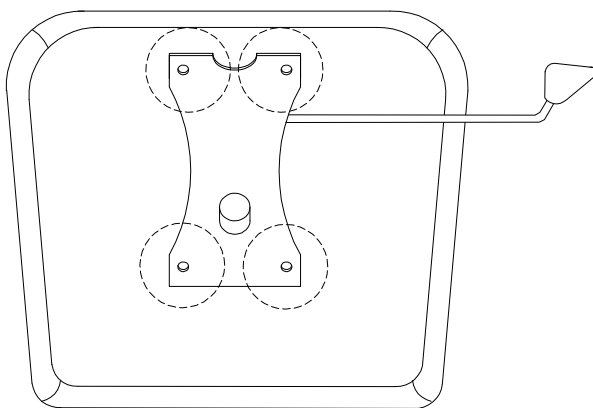
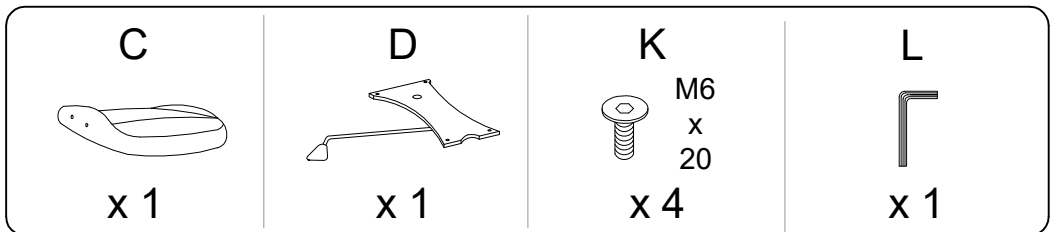

2

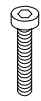

3

<b>B</b>  x 2	<b>I</b>  x 8	<b>J</b>  M8 x 30 x 8	<b>L</b>  x 1
--	--	--	--

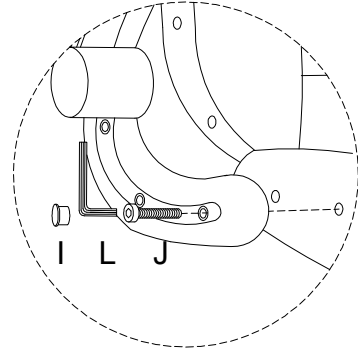
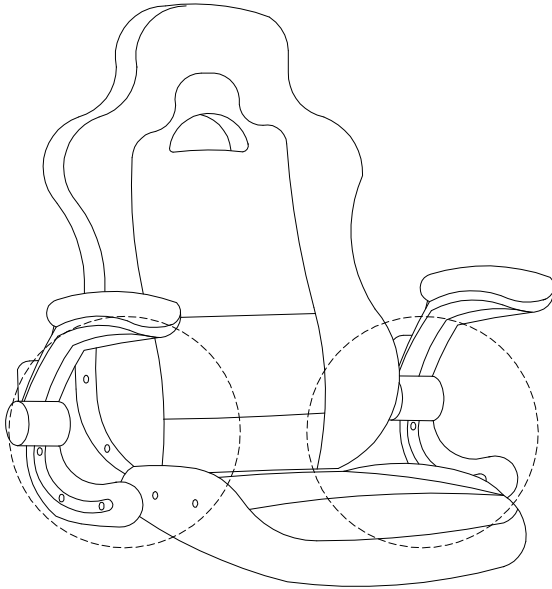

4

