

SAMSUNG

FULL MANUAL

HW-N400

Imagine the possibilities

Thank you for purchasing this Samsung product.

To receive more complete service, please register
your product at www.samsung.com/register

SAFETY INFORMATION

SAFETY WARNINGS

TO REDUCE THE RISK OF ELECTRIC SHOCK, DO NOT REMOVE THE COVER (OR BACK). NO USER-SERVICEABLE PARTS ARE INSIDE. REFER SERVICING TO QUALIFIED SERVICE PERSONNEL.

	<p style="text-align: center;">CAUTION RISK OF ELECTRIC SHOCK. DO NOT OPEN.</p>	
	<p>This symbol indicates that high voltage is present inside. It is dangerous to make any kind of contact with any internal part of this product.</p>	
	<p>This symbol indicates that this product comes with important literature concerning operation and maintenance.</p>	
	<p>Class II product : This symbol indicates that a safety connection to electrical earth (ground) is not required.</p>	
	<p>AC voltage : Rated voltage marked with this symbol is AC voltage.</p>	
	<p>DC voltage : Rated voltage marked with this symbol is DC voltage.</p>	
	<p>Caution. Consult Instructions for use : This symbol instructs the user to consult the user manual for further safety related information.</p>	

WARNING

- To reduce the risk of fire or electric shock, do not expose this appliance to rain or moisture.
- To prevent injury, this apparatus must be securely attached to the floor/wall in accordance with the installation instructions.
- This product contains chemicals known to the State of California to cause cancer and birth defects or other reproductive harm.

CAUTION

- Do not expose this apparatus to dripping or splashing. Do not put objects filled with liquids, such as vases, on the apparatus.
- To turn this apparatus off completely, you must pull the power plug out of the wall socket. Consequently, the power plug must be easily and readily accessible at all times.

FCC NOTE (for U.S.A.):

Class B FCC Statement

The included module(s) has been tested and found to comply with the limits for a Class B digital device, pursuant to Part 15 of the FCC Rules. These limits are designed to provide reasonable protection against harmful interference in a residential installation. This equipment generates, uses and can radiate radio frequency energy and, if not installed and used in accordance with the instructions, may cause harmful interference to radio communications. However, there is no guarantee that interference will not occur in a particular installation. If this equipment does cause harmful interference to radio or television reception, which can be determined by turning the equipment off and on, the user is encouraged to try to correct the interference by one of the following measures:

- Reorienting or relocating the receiving antenna.
- Increasing the separation between the equipment and receiver.
- Connecting the equipment to an outlet that is on a different circuit than the radio or TV.
- Consulting the dealer or an experienced radio/TV technician for help.

FCC Radiation Exposure Statement :

This equipment complies with FCC radiation exposure limits set forth for an uncontrolled environment.

This equipment should be installed and operated so there is at least 8 inches (20 cm) between the radiator and your body. This device and its antenna(s) must not be co-located or operated in conjunction with any other antenna or transmitter.

FCC Caution :

- Any changes or modifications not expressly approved by the party responsible for compliance could void the user’s authority to operate this equipment. This device complies with Part 15 of the FCC Rules. Operation is subject to the following two conditions: (1) This device may not cause harmful interference, and (2) this device must accept any interference received, including interference that may cause undesired operation.
- This product satisfies FCC regulations when shielded cables and connectors are used to connect the unit to other equipment. To prevent electromagnetic interference with electric appliances, such as radios and televisions, use shielded cables and connectors for connections.

Important Safety Instructions

Read these operating instructions carefully before using the unit. Follow all the safety instructions listed below. Keep these operating instructions handy for future reference.

1. Read these instructions.
2. Keep these Instructions.
3. Heed all warnings.
4. Follow all instructions.
5. Do not use this apparatus near water.
6. Clean only with a dry cloth.
7. Do not block any ventilation openings. Install in accordance with the manufacturer’s instructions.
8. Do not install near any heat sources such as radiators, heat registers, stoves, or other apparatus (including amplifiers) that produce heat.
9. Do not defeat the safety purpose of the polarized or grounding-type plug. A polarized plug has two blades with one wider than the other. A grounding type plug has two blades and a third grounding prong. The wide blade or the third prong are provided for your safety. If the provided plug does not fit into your outlet, consult an electrician for replacement of the obsolete outlet.
10. Protect the power cord from being walked on or pinched particularly at plugs, convenience receptacles, and the point where they exit from the apparatus.
11. Only use attachments/accessories specified by the manufacturer.

12. Use only with the cart, stand, tripod, bracket, or table specified by the manufacturer, or sold with the apparatus.



When a cart is used, use caution when moving the cart/apparatus combination to avoid injury from tip-over.

13. Unplug this apparatus during lightning storms or when unused for long periods of time.
14. Refer all servicing to qualified service personnel. Servicing is required when the apparatus has been damaged in any way, such as when the power-supply cord or plug is damaged, liquid has been spilled or objects have fallen into the apparatus, the apparatus has been exposed to rain or moisture, does not operate normally, or has been dropped.

PRECAUTIONS

1. Ensure that the AC power supply in your house complies with the power requirements listed on the identification sticker located on the bottom of your product. Install your product horizontally, on a suitable base (furniture), with enough space around it for ventilation (3~4 inches). Make sure the ventilation slots are not covered. Do not place the unit on amplifiers or other equipment which may become hot. This unit is designed for continuous use. To fully turn off the unit, disconnect the AC plug from the wall outlet. Unplug the unit if you intend to leave it unused for a long period of time.
2. During thunderstorms, disconnect the AC plug from the wall outlet. Voltage peaks due to lightning could damage the unit.
3. Do not expose the unit to direct sunlight or other heat sources. This could lead to overheating and cause the unit to malfunction.
4. Protect the product from moisture (i.e. vases), and excess heat (e.g. a fireplace) or equipment creating strong magnetic or electric fields. Unplug the power cable from the AC wall socket if the unit malfunctions. Your product is not intended for industrial use. It is for personal use only. Condensation may occur if your product has been stored in cold temperatures. If transporting the unit during the winter, wait approximately 2 hours until the unit has reached room temperature before using.
5. The battery used with this product contains chemicals that are harmful to the environment. Do not dispose of the battery in the general household trash. Do not expose the battery to excess heat, direct sunlight, or fire. Do not short circuit, disassemble, or overheat the battery. Danger of explosion if the battery is replaced incorrectly. Replace only with the same or equivalent type.

ABOUT THIS MANUAL

The user manual has two parts: this simple paper USER MANUAL and a detailed FULL MANUAL you can download.



USER MANUAL

See this manual for safety instructions, product installation, components, connections, and product specifications.



FULL MANUAL

You can access the Full Manual on Samsung's on-line customer support center by scanning the QR code. To see the manual on your PC or mobile device, download the manual in document format from Samsung's website.

(<http://www.samsung.com/support>)

Design and specifications are subject to change without prior notice.

CONTENTS

01	Checking the Components	2
	Inserting Batteries before using the Remote Control (AA batteries X 2)	2
02	Product Overview	3
	Front Panel / Right Side Panel of the Soundbar	3
	Bottom Panel of the Soundbar	4
03	Connecting the Soundbar	5
	Connecting Electrical Power	5
04	Connecting to your TV	6
	Method 1. Connecting with a Cable	6
	– Connecting using an Optical Cable	6
	– Connecting a TV using an HDMI Cable	7
	Method 2. Connecting Wirelessly	8
	– Connecting a TV via Bluetooth	8
05	Connecting an External Device	10
	Connecting using an Optical or Analog Audio (AUX) Cable	10
	Connecting using an HDMI Cable	11
06	Connecting a USB	12

07	Connecting a Mobile Device	14
	Connecting via Bluetooth	14
	Using the Samsung Audio Remote App	17
	– Installing the Samsung Audio Remote App	17
	– Launching the Samsung Audio Remote App	17
08	Using the Remote Control	18
	How to Use the Remote Control	18
	Adjusting the Soundbar volume with a TV remote control	21
	Using the Hidden Buttons	22
	Output specifications for the different sound effect modes	22
09	Installing the Wall Mount	23
	Installation Precautions	23
	Wallmount Components	23
10	Software Update	25
	Updating Procedure	26
	If UPDATE is not displayed	26
11	Troubleshooting	27
12	License	28
13	Open Source License Notice	28
14	Important Notes About Service	28
15	Specifications and Guide	29
	Specifications	29

01 CHECKING THE COMPONENTS

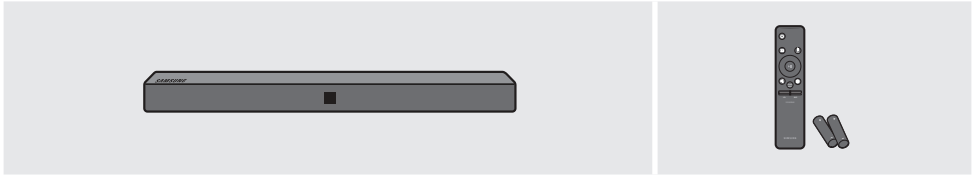

Soundbar Main Unit

Remote Control / Batteries
(AH59-02766A)

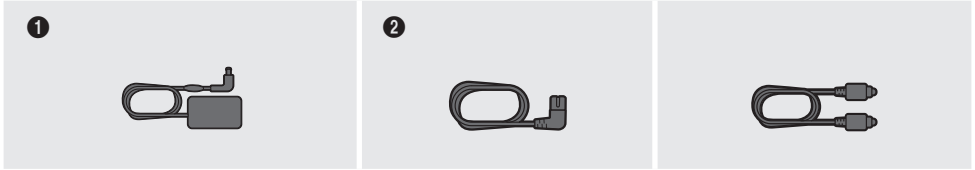

1

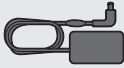

AC/DC Adapter (Main Unit)
(BN44-00862A)

2



Power Cord (AC/DC Adapter)
(3903-001117)



Optical Cable
(AH39-00779A)

- For more information about the power supply and power consumption, refer to the label attached to the product. (Label : Bottom of the Soundbar Main Unit)
- The power components are labelled (1, 2). For more information about power connections, see page 5.
- For Soundbar wall mounting components, see page 23.
- The Micro USB to USB adapter and HDMI cables are sold separately. To purchase, contact a Samsung Service Center or Samsung Customer Care.
- The appearance of the accessories may differ slightly from the illustrations above.

Inserting Batteries before using the Remote Control (AA batteries X 2)

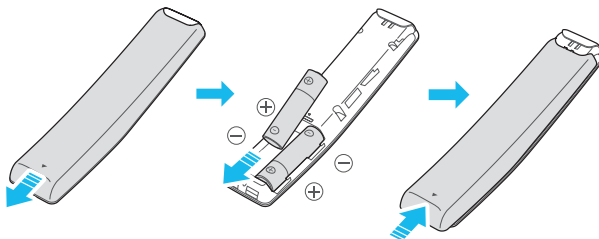

Slide the battery cover in the direction of the arrow until it is completely removed. Insert 2 AA batteries (1.5V) oriented so that their polarity is correct. Slide the battery cover back into position.

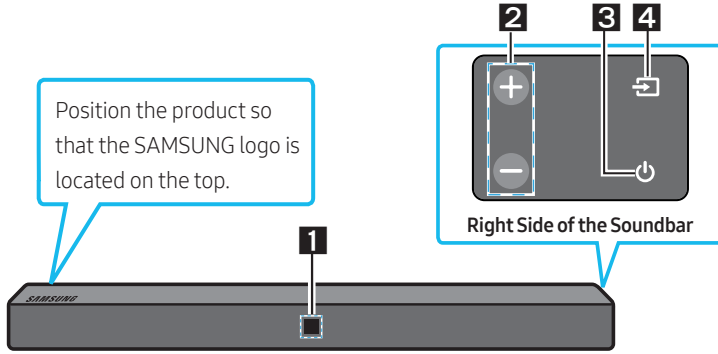

02 PRODUCT OVERVIEW

Front Panel / Right Side Panel of the Soundbar



1	Display Displays the product's status and current mode.														
2	+/- (Volume) Button Adjusts the volume. <ul style="list-style-type: none"> When adjusted, the volume level appears on the Soundbar's front display. 														
3	 (Power) Button Turns the power on and off.														
4	 (Source) Button Selects the source input mode. <table border="1" data-bbox="151 941 862 1197" style="width: 100%; border-collapse: collapse; text-align: center;"> <thead> <tr> <th style="padding: 5px;">Input mode</th> <th style="padding: 5px;">Display</th> </tr> </thead> <tbody> <tr> <td style="padding: 5px;">Optical Digital input</td> <td style="padding: 5px;">D.IN</td> </tr> <tr> <td style="padding: 5px;">ARC (HDMI OUT) input</td> <td style="padding: 5px;">D.IN → TV ARC (Auto conversion)</td> </tr> <tr> <td style="padding: 5px;">AUX input</td> <td style="padding: 5px;">AUX</td> </tr> <tr> <td style="padding: 5px;">HDMI input</td> <td style="padding: 5px;">HDMI</td> </tr> <tr> <td style="padding: 5px;">BLUETOOTH mode</td> <td style="padding: 5px;">BT</td> </tr> <tr> <td style="padding: 5px;">USB mode</td> <td style="padding: 5px;">USB</td> </tr> </tbody> </table> <ul style="list-style-type: none"> To turn on "BT PAIRING" mode, change the source to "BT" mode, and then press and hold the  (Source) button for more than 5 seconds. 	Input mode	Display	Optical Digital input	D.IN	ARC (HDMI OUT) input	D.IN → TV ARC (Auto conversion)	AUX input	AUX	HDMI input	HDMI	BLUETOOTH mode	BT	USB mode	USB
Input mode	Display														
Optical Digital input	D.IN														
ARC (HDMI OUT) input	D.IN → TV ARC (Auto conversion)														
AUX input	AUX														
HDMI input	HDMI														
BLUETOOTH mode	BT														
USB mode	USB														

- When you plug in the AC cord, the power button will begin working in 4 to 6 seconds.
- When you turn on this unit, there will be a 4 to 5 second delay before it produces sound.
- If you want to enjoy sound only from the Soundbar, you must turn off the TV's speakers in the Audio Setup menu of your TV. Refer to the owner's manual supplied with your TV.

Bottom Panel of the Soundbar

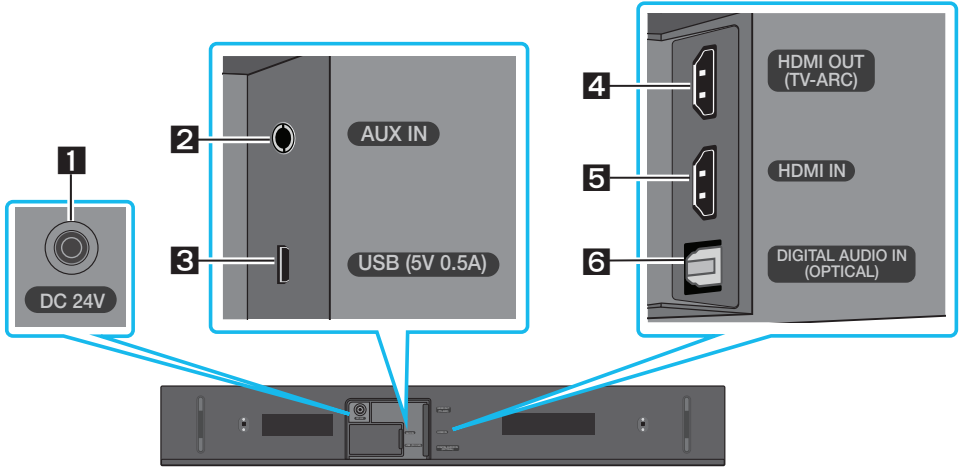

1	DC 24V (Power Supply In) Connect the AC/DC power adaptor.
2	AUX IN Connect to the Analog output of an external device.
3	USB (5V 0.5A) Connect a USB device here to play music files on the USB device through the Soundbar.
4	HDMI OUT (TV-ARC) Connect to the HDMI (ARC) jack on a TV.
5	HDMI IN Inputs digital video and audio signals simultaneously using an HDMI cable. Connect to the HDMI output of an external device.
6	DIGITAL AUDIO IN (OPTICAL) Connect to the digital (optical) output of an external device.

- When disconnecting the power cable of the AC/DC power adaptor from a wall outlet, pull the plug. Do not pull the cable.
- Do not connect this unit or other components to an AC outlet until all connections between components are complete.

03 CONNECTING THE SOUNDBAR

Connecting Electrical Power

Use the power components (1, 2) to connect the Soundbar to an electrical outlet in the following order:

- 1 Connect the power output cable to the power adapter, and then to the Soundbar.
- 2 Connect the power cord to a wall socket.

See the illustrations below.

- For more information about the required electrical power and power consumption, refer to the label attached to the product. (Label : Bottom of the Soundbar Main Unit)

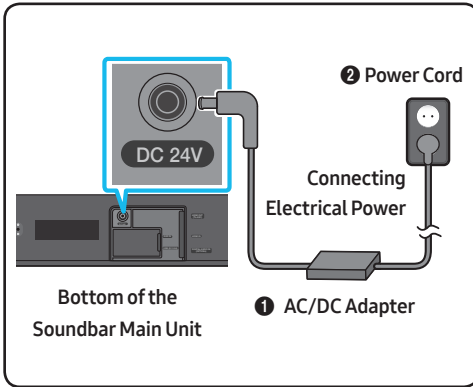

- Make sure to rest the AC/DC Adapter flat on a table or the floor. If you place the AC/DC Adapter so that it is hanging with the AC cord input facing upwards, water or other foreign substances could enter the Adapter and cause the Adapter to malfunction.

Expand to true wireless surround sound by connecting the Samsung Wireless Rear Speaker Kit (SWA-8500S) to your Soundbar (Sold separately). For more information, see the Samsung Wireless Rear Speaker Kit manual.

04 CONNECTING TO YOUR TV

Hear TV sound from your Soundbar through wired or wireless connections.

- When the Soundbar is connected to selected Samsung TVs, the Soundbar can be controlled using the TV's remote control.
 - When you connect using an optical cable, this feature is supported by 2017 Samsung Smart TVs that support Bluetooth.
 - This function also allows you to use the TV menu to adjust the sound field and various settings as well as the volume and mute.

Method 1. Connecting with a Cable

Connecting using an Optical Cable

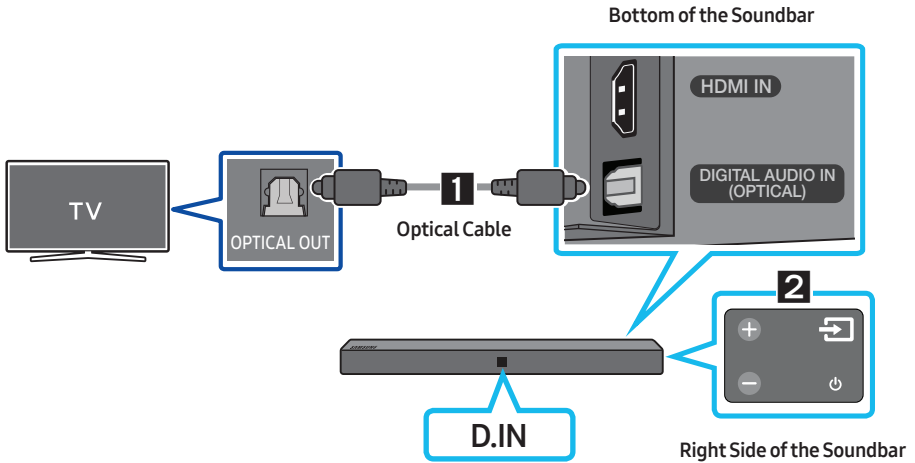

1. Connect the **DIGITAL AUDIO IN (OPTICAL)** jack on the Soundbar to the **OPTICAL OUT** jack of the TV with a digital optical cable.
2. Press the **Source** button on the right side panel or remote control, and then select the **"D.IN"** mode.

Auto Power Link

Auto Power Link automatically turns on the Soundbar when the TV is turned on.

1. Connect the Soundbar and a TV with a digital optical cable.
2. Press the  (**Source**) button on the right side panel or on the remote control, and then select “D.IN”.
3. Press the **Left** button on the remote control for 5 seconds to turn Auto Power Link on or off.
 - Auto Power Link is set to ON by default.
(To turn off this function, turn off Auto Power on the Soundbar.)
 - Depending on the connected device, Auto Power Link may not function.
 - This function is only available in the “D.IN” mode.



Connecting a TV using an HDMI Cable

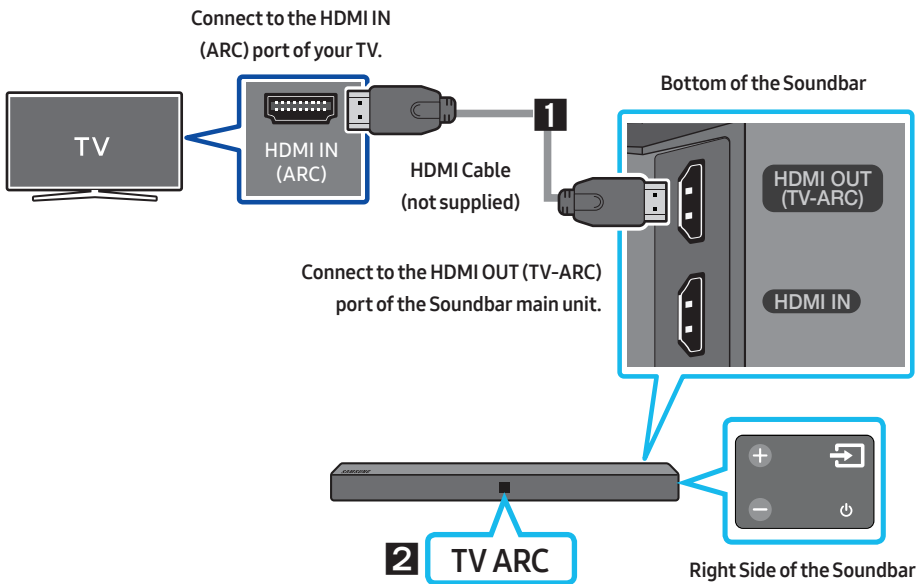

1. With the Soundbar and TV turned on, connect the HDMI cable (not supplied) as shown in the figure.
2. “TV ARC” appears in the display window of the Soundbar main unit and the Soundbar plays TV sound.
 - If TV sound is inaudible, press the  (**Source**) button on the remote control or on the right side of the Soundbar to switch to “D.IN” mode. The screen displays “D.IN” and “TV ARC” in sequence, and TV sound is played.

- If “**TV ARC**” does not appear in the display window of the Soundbar main unit, confirm that the cable is connected to the correct port.
- Use the volume buttons on the TV’s remote control to change the volume on the Soundbar.

NOTES

- HDMI is an interface that enables the digital transmission of video and audio data with just a single connector.
- If the TV provides an ARC port, connect the HDMI cable to the HDMI IN (ARC) port.
- We recommend you use a coreless HDMI cable if possible. If you use a cored HDMI cable, use one whose diameter is less than 0.55 inches.
- Anynet+ must be turned on.
- This function is not available if the HDMI cable does not support ARC.

Method 2. Connecting Wirelessly

Connecting a TV via Bluetooth

When a TV is connected using Bluetooth, you can hear stereo sound without the hassle of cabling.

- Only one TV can be connected at a time.



The initial connection

1. Press the **[Source]** button on the right side panel or on the remote control, and then select “**BT**”.
2. Change “**BT**” to “**BT PAIRING**”.
 - When “**BT READY**” appears, press the **PAIR** button on the remote control or press and hold the **[Source]** button on the right side panel of the Soundbar for more than 5 seconds to display “**BT PAIRING**”.
3. Select Bluetooth mode on the TV. (For more information, see the TV’s manual.)
4. Select “[**AV**] **Samsung Soundbar Nxxx N-Series**” from the list on TV’s screen.



An available Soundbar is indicated with “**Need Pairing**” or “**Paired**” on the TV Bluetooth device list. To connect the TV to the Soundbar, select the message, and then establish a connection.

 - When the TV is connected, [**TV Name**] → “**BT**” appears on the Soundbar’s front display.
5. You can now hear TV sound from the Soundbar.



NOTE

- After you have connected the Soundbar to your TV the first time, use the “**BT READY**” mode to reconnect. See Page 9 for details.

If the device fails to connect

- If the previously connected Soundbar listing (e.g. “[AV] Samsung Soundbar Nxxx N-Series”) appears in the list, delete it.
- Press the  PAIR button on the remote control or in “BT” mode, press and hold the  (Source) button for more than 5 seconds on the right side of the Soundbar to switch to “BT PAIRING” mode. Then, select “[AV] Samsung Soundbar Nxxx N-Series” from the TV’s search list.

What is the difference between BT READY and BT PAIRING?

- **BT READY** : In this mode, you can search for previously connected TVs or connect a previously connected mobile device to the Soundbar.
- **BT PAIRING** : In this mode, you can connect a new device to the Soundbar. (Press the  PAIR button on the remote control or press and hold the  (Source) button for more than 5 seconds on the right side of the Soundbar while in “BT” mode.)

NOTES

- If asked for a PIN code when connecting a Bluetooth device, enter <0000>.
- In Bluetooth connection mode, the Bluetooth connection will be lost if the distance between the Soundbar and the Bluetooth device exceeds 32.8 ft.
- The Soundbar automatically turns off after 5 minutes in the Ready state.
- The Soundbar may not perform Bluetooth search or connection correctly under the following circumstances:
 - If there is a strong electrical field around the Soundbar.
 - If several Bluetooth devices are simultaneously paired with the Soundbar.
 - If the Bluetooth device is turned off, not in place, or malfunctions.
- Electronic devices may cause radio interference. Devices that generate electromagnetic waves must be kept away from the Soundbar main unit - e.g., microwaves, wireless LAN devices, etc.

Disconnecting the Soundbar from the TV

Press the  (Source) button on the right side panel or on the remote control and switch to any mode but “BT”.

- Disconnecting takes time because the TV must receive a response from the Soundbar. (The time required may differ, depending on the TV model.)
- To cancel the automatic Bluetooth connection between the Soundbar and TV, press the  (Play/Pause) button on the remote control for 5 seconds in “BT READY” status. (Toggle On → Off)

05 CONNECTING AN EXTERNAL DEVICE

Connect to an external device via a wired or wireless network to play the external device's sound through the Soundbar.

Connecting using an Optical or Analog Audio (AUX) Cable

BD / DVD player / Set-top box /
Game console

Right Side of the Soundbar

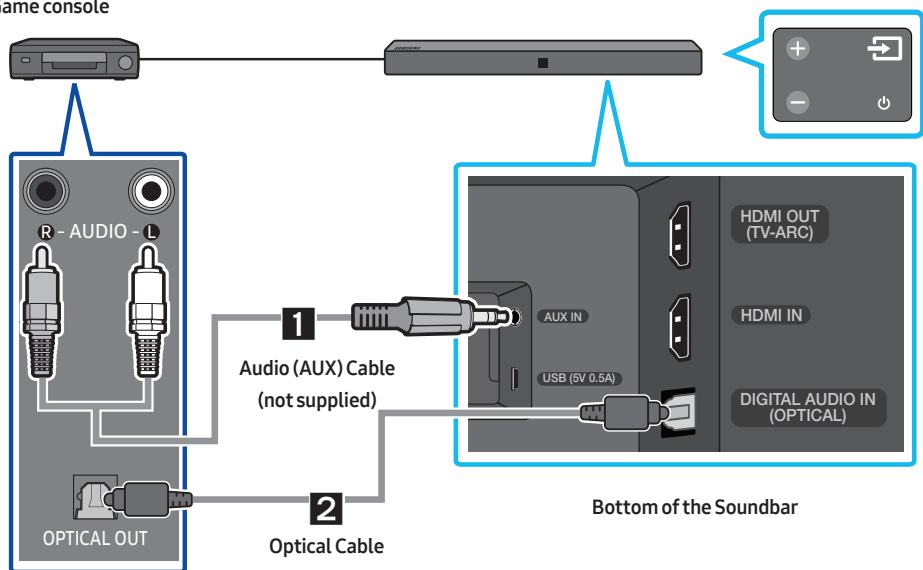

1 Audio (AUX) Cable

- 1 Connect **AUX IN** (Audio) on the main unit to the AUDIO OUT jack of the Source Device using an audio cable.
- 2 Select "**AUX**" mode by pressing  (**Source**) button on the right side panel or on the remote control.

2 Optical Cable

- 1 Connect **DIGITAL AUDIO IN (OPTICAL)** on the main unit to the OPTICAL OUT jack of the Source Device using a digital optical cable.
- 2 Select "**D.IN**" mode by pressing the  (**Source**) button on the right side panel or on the remote control.

Connecting using an HDMI Cable

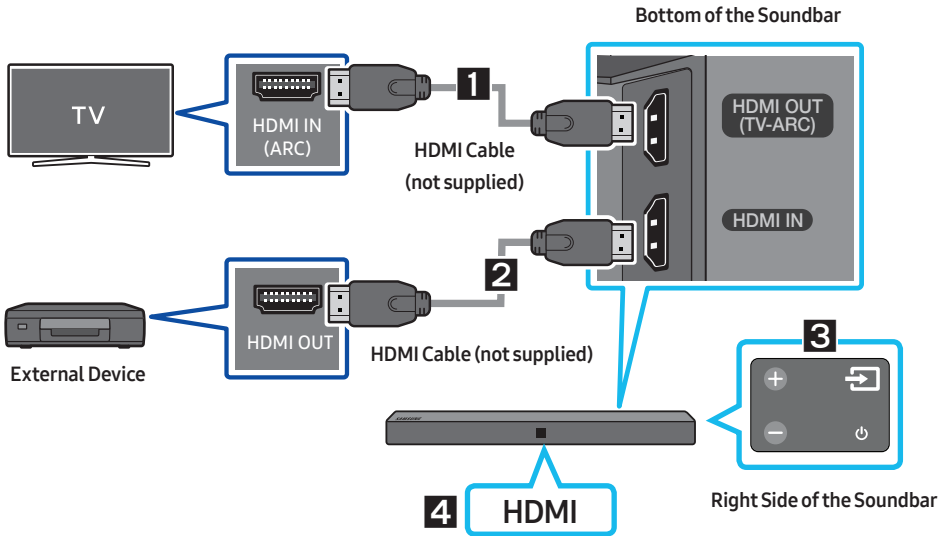

1. Connect an HDMI cable (not supplied) from the **HDMI OUT (TV-ARC)** jack on the back of the product to the HDMI IN jack on your TV.
2. Connect an HDMI cable (not supplied) from the **HDMI IN** jack on the back of the product to the HDMI OUT jack on your digital device.
3. Press the  (**Source**) button on the right side panel or on the remote control, and then select **"HDMI"**.
4. **"HDMI"** mode is displayed on the Soundbar display panel and sound plays.

06 CONNECTING A USB

You can play music files located on USB storage devices through the Soundbar.

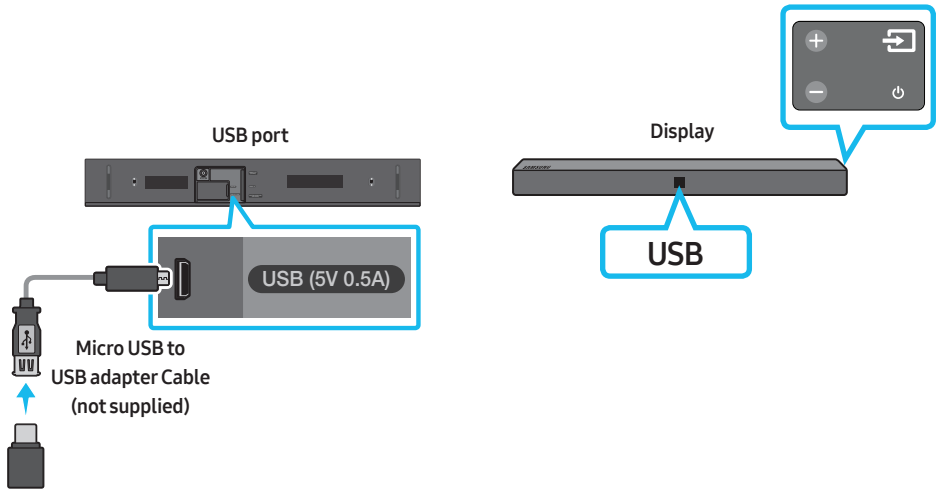

1. Connect a Micro USB to USB adapter cable with a male USB 2.0 Micro USB plug (Type B) on one end and a standard female 2.0 USB jack (Type A) on the other to the micro USB jack on your Soundbar.
 - The Micro USB to USB adapter cable is sold separately. To purchase, contact a Samsung Service Center or Samsung Customer Care.
2. Connect your USB device to the female end of the adapter cable.
3. Press the  (**Source**) button on the right side panel or on the remote control, and then select "USB".
4. "USB" appears in the display screen.
5. Play music files from the USB storage device through the Soundbar.
 - The Soundbar automatically turns off (Auto Power Off) if no USB device has been connected for more than 5 minutes.

File Format Type Compatibility list

Extension	Codec	Sampling Rate	Bitrate
*.mp3	MPEG 1 Layer2	16KHz ~ 48KHz	80kbps~320kbps
	MPEG 1 Layer3	16KHz ~ 48KHz	80kbps~320kbps
	MPEG 2 Layer3	16KHz ~ 48KHz	80kbps~320kbps
	MPEG 2.5 Layer3	16KHz ~ 48KHz	80kbps~320kbps
*.wma	Wave_Format_MSAudio1	16KHz ~ 48KHz	56kbps-128kbps
	Wave_Format_MSAudio2	16KHz ~ 48KHz	56kbps-128kbps
*.aac	AAC	16KHz ~ 96KHz	48kbps~320kbps
	AAC-LC	16KHz ~ 96KHz	128kbps~192kbps 5.1ch 320kbps
	HE-AAC	24KHz ~ 96KHz	48kbps~64kbps 5.1ch 160kbps
*.wav	-	16KHz ~ 48KHz	up to 3000kbps
*.ogg	OGG 1.1.0	16KHz ~ 48KHz	50kbps~500kbps
*.flac	FLAC 1.1.0, FLAC 1.2.1	16KHz ~ 96KHz	up to 3000kbps

- If there are too many folders and files stored on the USB device, it may take the Soundbar some time to access and play files.

07 CONNECTING A MOBILE DEVICE



Connecting via Bluetooth

When a mobile device is connected using Bluetooth, you can hear stereo sound without the hassle of cabling.

- You cannot connect more than one Bluetooth device at a time.





The initial connection

1. Press the  (**Source**) button on the right side panel or on the remote control, and then select “BT”.
2. Change “BT” to “BT PAIRING”.
 - When “BT READY” appears, press the  PAIR button on the remote control or press and hold the  (**Source**) button on the right side panel of the Soundbar for more than 5 seconds to display “BT PAIRING”.
3. Select “[AV] Samsung Soundbar Nxxx N-Series” from the list that appears.
 - When the Soundbar is connected to the Bluetooth device, [Bluetooth Device Name] → “BT” appears in the front display.
4. Play music files from the device, connected via Bluetooth, through the Soundbar.

NOTE

- After you have connected the Soundbar to your mobile device the first time, use the “BT READY” mode to reconnect. See Page 15 for details.

If the device fails to connect

- If a previously connected Soundbar listing (e.g. “[AV] Samsung Soundbar Nxxx N-Series”) appears in the list, delete it.
- Press the  PAIR button on the remote control or in “BT” mode, press and hold the  (**Source**) button for more than 5 seconds on the right side of the Soundbar to switch to “BT PAIRING” mode. Then, select “[AV] Samsung Soundbar Nxxx N-Series” from the Bluetooth device search list.

What is the difference between BT READY and BT PAIRING?

- **BT READY** : In this mode, you can search for previously connected TVs or connect a previously connected mobile device to the Soundbar.
- **BT PAIRING** : In this mode, you can connect a new device to the Soundbar. (Press the **PAIR** button on the remote control or press and hold the  **(Source)** button for more than 5 seconds on the right side of the Soundbar while in “BT” mode.)

NOTES

- If asked for a PIN code when connecting a Bluetooth device, enter <0000>.
- In Bluetooth connection mode, the Bluetooth connection will be lost if the distance between the Soundbar and the Bluetooth device exceeds 32.8 ft.
- The Soundbar automatically turns off after 5 minutes in the Ready state.
- The Soundbar may not perform Bluetooth search or connection correctly under the following circumstances:
 - If there is a strong electrical field around the Soundbar.
 - If several Bluetooth devices are simultaneously paired with the Soundbar.
 - If the Bluetooth device is turned off, not in place, or malfunctions.
- Electronic devices may cause radio interference. Devices that generate electromagnetic waves must be kept away from the Soundbar main unit - e.g., microwaves, wireless LAN devices, etc.
- The Soundbar supports SBC data (44.1kHz, 48kHz).
- Connect only to a Bluetooth device that supports the A2DP (AV) function.
- You cannot connect the Soundbar to a Bluetooth device that supports only the HF (Hands Free) function.
- Once you have paired the Soundbar to a Bluetooth device, selecting “**[AV] Samsung Soundbar Nxxx N-Series**” from the device’s scanned devices list will automatically change the Soundbar to “**BT**” mode.
 - Available only if the Soundbar is listed among the Bluetooth device’s paired devices. (The Bluetooth device and the Soundbar must have been previously paired at least once.)
- The Soundbar will appear in the Bluetooth device’s searched devices list only when the Soundbar is displaying “**BT READY**”.
- Soundbar cannot be paired to another Bluetooth device, while using the Bluetooth function.

Bluetooth POWER On (Bluetooth POWER)

If a previously paired Bluetooth device tries to pair with the Soundbar when the Bluetooth POWER On function is on and the Soundbar is turned off, the Soundbar turns on automatically.

1. Press and hold the **SOUND MODE** button for more than 5 seconds on the remote while the Soundbar is turned on.
2. “**ON-BLUETOOTH POWER**” appears on the Soundbar’s display.

Disconnecting the Bluetooth device from a Soundbar

You can disconnect a Bluetooth device from the Soundbar. For instructions, see the Bluetooth device's user manual.

- The Soundbar will be disconnected.
- When the Soundbar is disconnected from the Bluetooth device, the Soundbar will display **"BT DISCONNECTED"** on the front display.

Disconnecting the Soundbar from the Bluetooth device

Press the  (**Source**) button on the right side panel or on the remote control, and then change to any mode except **"BT"**.

- Disconnecting takes time because the Bluetooth device must receive a response from the Soundbar. (Disconnection time may differ, depending on the Bluetooth device)
- When the Soundbar is disconnected from the Bluetooth device, the Soundbar will display **"BT DISCONNECTED"** on the front display.

NOTES

- In Bluetooth connection mode, the Bluetooth connection will be lost if the distance between the Soundbar and the Bluetooth device exceeds 32.8 ft.
- The Soundbar automatically turns off after 5 minutes in the Ready state.

More About Bluetooth

Bluetooth is a technology that enables Bluetooth-compliant devices to interconnect easily with each other using a short wireless connection.

- A Bluetooth device may cause noise or malfunction, depending on usage, if:
 - A part of your body is in contact with the receiving/transmitting system of the Bluetooth device or the Soundbar.
 - It is subject to electrical variation from obstructions caused by a wall, corner, or office partition.
 - It is exposed to electrical interference from same frequency-band devices including medical equipment, microwave ovens, and wireless LANs.
- Pair the Soundbar with the Bluetooth device while they are close together.
- The further the distance between the Soundbar and Bluetooth device, the worse the quality is. If the distance exceeds the Bluetooth operational range, the connection is lost.
- In poor reception areas, the Bluetooth connection may not work properly.
- The Bluetooth connection only works when it is close to the unit. The connection will be automatically cut off if the Bluetooth device is out of range. Even within range, the sound quality may be degraded by obstacles such as walls or doors.
- This wireless device may cause electric interference during its operation.

Using the Samsung Audio Remote App

Installing the Samsung Audio Remote App

To control the Soundbar with your smart device and the Samsung Audio Remote app, download the Samsung Audio Remote app from the Google Play store.

Market search : Samsung Audio Remote



Launching the Samsung Audio Remote App

To launch and use the Samsung Audio Remote app, touch the Audio Remote icon on your smart device, and then follow the directions on the screen.









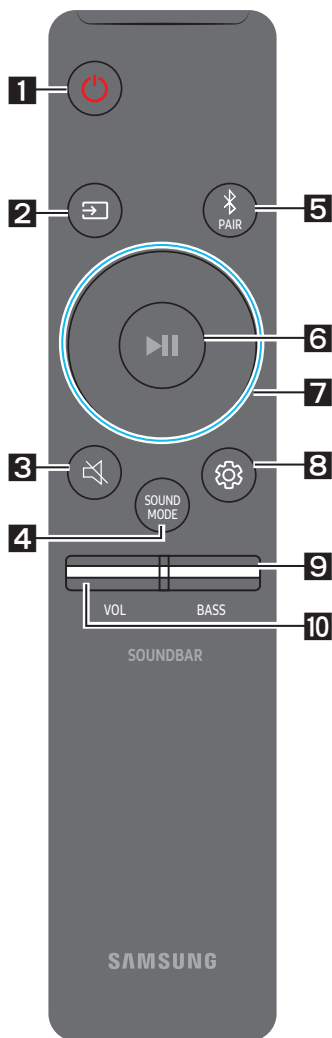





- The Samsung Audio Remote app is only compatible with Android mobile phones and mobile devices running Android OS 3.0 or later.

08 USING THE REMOTE CONTROL

How to Use the Remote Control



1	 Power	Turns the Soundbar on and off.
2	 Source	Press to select a source connected to the Soundbar. <ul style="list-style-type: none">• BT PAIRING mode To turn on "BT PAIRING" mode, press and hold the  (Source) button for more than 5 seconds.
3	 Mute	Press the  (Mute) button to mute the sound. Press it again to unmute the sound.
4	 SOUND MODE	You can select the desired sound effect by choosing STANDARD or SURROUND . <ul style="list-style-type: none">• DRC (Dynamic Range Control) Lets you apply dynamic range control to Dolby Digital tracks. If you press and hold the SOUND MODE button while in standby mode, DRC (Dynamic Range Control) turns on or off. With the DRC turned on, loud sound is reduced. (The sound may be distorted.)• Bluetooth Power This feature automatically turns Soundbar on when receiving a connection request from a previously connected TV or Bluetooth device. The setting is On by default.<ul style="list-style-type: none">– Press and hold the SOUND MODE button for more than 5 seconds to turn off Bluetooth Power function.

<p>5</p>  <p>Bluetooth PAIR</p>	<p>Press the  PAIR button. “BT PAIRING” appears in the Soundbar’s display. You can connect to a new Bluetooth device in this mode by selecting the device from the Bluetooth device search list.</p>
<p>6</p>  <p>Play / Pause</p>	<p>Press the  button to pause a music file temporarily. When you press the button again, the music file plays.</p> <ul style="list-style-type: none"> • Auto Power Down Function The unit turns off automatically in the following situations. <ul style="list-style-type: none"> – D.IN / HDMI / BT / USB Mode : If there is no audio signal for 5 minutes. – AUX Mode : <ul style="list-style-type: none"> – If the Audio (AUX) Cable is disconnected for 5 minutes. – If there is no KEY input for 8 hours when the Audio (AUX) Cable is connected. (Auto Power Down function can be turned off only in that case.) – To turn off Auto Power Down function, while in “AUX” mode, press and hold the  button for 5 seconds. “ON-AUTO POWER DOWN” / “OFF-AUTO POWER DOWN” appears on the display.
<p>7</p>  <p>Up/Down/ Left/Right</p>	 <p>Press the indicated areas to select Up/Down/Left/Right.</p> <p>Press Up/Down/Left/Right on the button to select or set functions.</p> <ul style="list-style-type: none"> • Repeat To use the Repeat function in “USB” mode, press the Up button. • Music Skip Press the Right button to select the next music file. Press the Left button to select the previous music file. • Anynet+ / Auto Power Link You can turn Anynet+ and Auto Power Link on or off. Anynet+ and Auto Power Link are controlled by the Right and Left buttons respectively. <ul style="list-style-type: none"> – Anynet+ : If the Soundbar is connected to a Samsung TV through an HDMI cable, you can control your Soundbar with a Samsung TV remote control. Press and hold the Right button for 5 seconds to toggle Anynet+ ON and OFF. – Auto Power Link : If the Soundbar is connected to your TV through a digital optical cable, the Soundbar can automatically turn on when you turn on your TV. Press and hold the Left button for 5 seconds to toggle Auto Power Link ON and OFF. – Anynet+ / Auto Power Link are set to ON by default.

- **Volume restriction function**

Because it may damage hearing when the power is turned on at high volumes, it adjusts the volume to 20 when the set volume is higher than 20.

- The default value for Volume restriction is off. The set volume is maintained even when the power is turned off.
- To change the setting, press and hold the **Down** button on the remote control for 5 seconds. With the volume restriction off, “**V FREE**” appears on the front display and with the function on, “**V LOCK**” appears.

8



Sound Control

You can select from **TREBLE**, **AUDIO SYNC**, **REAR LEVEL**, or **REAR SPEAKER ON/OFF**.

- To adjust the **TREBLE** volume, select Sound Control **TREBLE**, and then use the **Up/Down** buttons to adjust the volume within the -6 to +6 range.
- Press and hold the  (**Sound Control**) button for about 5 seconds to adjust the sound for each frequency band. 150Hz, 300Hz, 600Hz, 1.2KHz, 2.5KHz, 5KHz, and 10KHz are selectable (**Left/Right**) and each can be adjusted to a setting between -6 ~ +6 (**Up/Down**).
- If the video and audio between the TV and your Soundbar are not synchronized, select **AUDIO SYNC** in Sound Settings, and then set audio delay between 0~300 milliseconds by using the **Up/Down** buttons. (Except “**USB**” mode)
- If surround speakers (not supplied) are connected, select **REAR LEVEL** and use the **Up/Down** buttons to adjust the volume within the -6 to +6 range. The **REAR SPEAKER** function can be turned **ON/OFF** by using the **Up/Down** buttons.
- **AUDIO SYNC** is only supported in some functions.

9



BASS

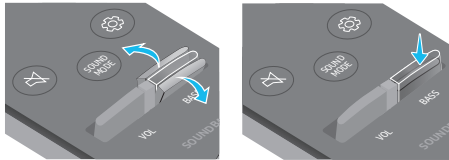

Push the button up or down to adjust the bass volume within the -6 to +6 range. To set the bass volume level to 0, press the button.

10



VOL

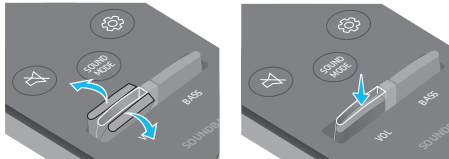

Push the button up or down to adjust the volume.

- **Mute**



Press the **VOL** button to mute the sound. Press it again to unmute the sound.

Adjusting the Soundbar volume with a TV remote control

Use the TV menu to set the TV speaker on a Samsung TV to external speakers.
(For more information, see the TV's user manual.)

- After installing the Soundbar, you can adjust the Soundbar's volume using the IR remote control that came with a Samsung TV. (If you do not want to use this function, when the Soundbar is on, push the **BASS** button up and hold it for 5 seconds. "OFF-TV REMOTE" appears in the Soundbar's display and the function turns off.)
To adjust the volume using only the Samsung TV remote control, push the **BASS** button up and hold it for more than 5 seconds until "SAMSUNG-TV REMOTE" appears in the Soundbar display.
 - Each time you push the **BASS** button up and hold it for 5 seconds, the mode switches in the following order: "SAMSUNG-TV REMOTE" (Default mode) → "OFF-TV REMOTE" → "ALL-TV REMOTE".
- To adjust the Soundbar volume with the remote control that came with a TV made by a third party manufacturer, turn the Soundbar on, push the **BASS** button up and hold it for 5 seconds ("OFF-TV REMOTE" appears on the Soundbar's display), release the **BASS** button, and then push the **BASS** button up and hold it again for more than 5 seconds. ("ALL-TV REMOTE" appears on the Soundbar's display.)
 - This function may not be available, depending on the remote control.
 - Manufacturers supporting this function:
VIZIO, LG, Sony, Sharp, PHILIPS, PANASONIC, TOSHIBA, GRUNDIG, Hisense, RCA

Using the Hidden Buttons

Hidden Button		Reference page
Remote Control Button	Function	
BASS	TV remote control On/Off (Standby)	page 21
 (Source)	BT Paring	page 18
▶ (Play / Pause)	Auto Power Down On/Off (AUX mode)	page 19
	Initialize (Standby)	page 26
	BT Ready	page 9
Left	Auto Power Link ON/OFF	page 19
Right	Anynet+ ON/OFF	page 19
Down	Volume restriction On/Off	page 20
 (Sound Control)	7 Band EQ	page 20
SOUND MODE	DRC ON/OFF (Standby)	page 18
	Bluetooth Power	page 18

Output specifications for the different sound effect modes

Effect		Input	Output	
			Except Wireless Rear Speaker Kit	Include Wireless Rear Speaker Kit
 SOUND MODE	STANDARD	2.0 ch	2.0 ch	4.0 ch
		5.1 ch	2.0 ch	4.0 ch
	SURROUND	2.0 ch	2.0 ch	4.0 ch
		5.1 ch	2.0 ch	4.0 ch

- Samsung Wireless Rear Speaker Kit can be purchased separately. To purchase a Kit, contact the vendor you purchased the Soundbar from.

09 INSTALLING THE WALL MOUNT

Installation Precautions

- Install on a vertical wall only.
- Do not install in a place with high temperature or humidity.
- Verify whether the wall is strong enough to support the product's weight. If not, reinforce the wall or choose another installation point.
- Purchase and use the fixing screws or anchors appropriate for the kind of wall you have (plaster board, iron board, wood, etc.). If possible, fix the support screws into wall studs.
- Purchase wall mounting screws according to the type and thickness of the wall you want to mount the Soundbar on.
 - Diameter: M5
 - Length: 1 3/8 inches or longer recommended.
- Connect cables from the unit to external devices before you install the Soundbar on the wall.
- Make sure the unit is turned off and unplugged before you install it. Otherwise, it may cause an electric shock.

Wallmount Components



Wall Mount Guide (AH63-04369B)



Holder-Screw (2 EA)
(AH61-04110A)



Screw (2 EA)
(6001-001202)



Bracket-Wall Mount (2 EA)
(AH61-04119A)

1. Place the **Wall Mount Guide** against the wall surface.
 - The **Wall Mount Guide** must be level.
 - If your TV is mounted on the wall, install the Soundbar at least 2 inches (5 cm) below the TV.



↕ 2 inches or more

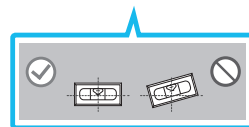

2. Align the Paper Template's **Center Line** with the center of your TV (if you are mounting the Soundbar below your TV), and then fix the **Wall Mount Guide** to the wall using tape.
- If you are not mounting below a TV, place the **Center Line** in the center of the installation area.

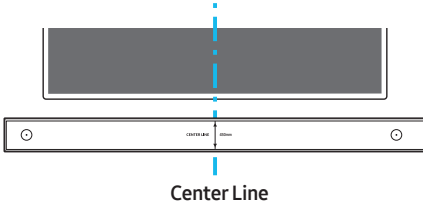

3. Use a sharp object, such as a pen or pencil, to mark the holes' positions, and then remove the **Wall mount Guide**.

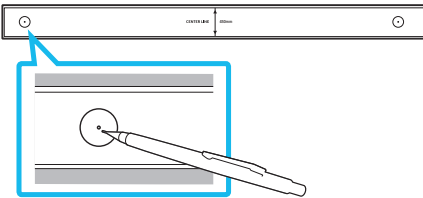

4. Using an appropriately sized drill bit, drill a hole in the wall at each marking.
- If the markings do not correspond to the positions of studs, make sure you insert appropriate anchors or mollies into the holes before you insert the support screws. If you use anchors or mollies, make sure the holes you drill are large enough for the anchors or mollies you use.

5. Push a screw (not supplied) through each **Holder-Screw**, and then screw each screw firmly into a support screw hole.

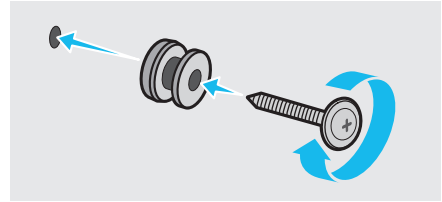

6. Install the 2 **Bracket-Wall Mounts** in the correct orientation on the bottom of the Soundbar using 2 **Screws**.

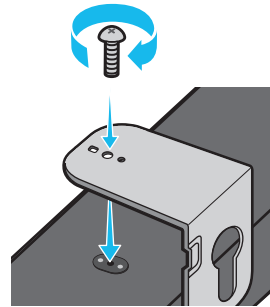

- When assembling, make sure the hanger part of the **Bracket-Wall Mounts** are located behind the rear of the Soundbar.

Rear of Soundbar

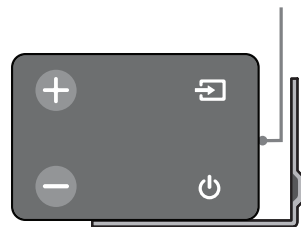

Right end of Soundbar

7. Install the Soundbar with the attached **Bracket-Wall Mounts** by hanging the **Bracket-Wall Mounts** on the **Holder-Screws** on the wall.

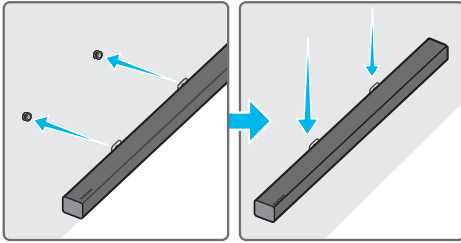

8. Slide the Soundbar down as shown below so that the **Bracket-Wall Mounts** rest securely on the **Holder-Screws**.

- Insert the **Holder-Screws** into the wide (bottom) part of the **Bracket-Wall Mounts**, and then slide the **Bracket-Wall Mounts** down so that **Bracket-Wall Mounts** rest securely on the **Holder-Screws**.

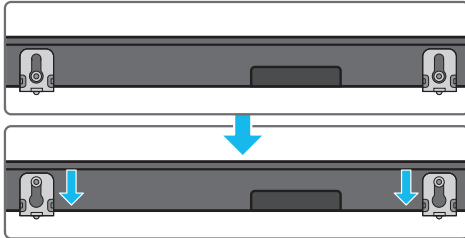

10 SOFTWARE UPDATE

Samsung may offer updates for the Soundbar's system firmware in the future.

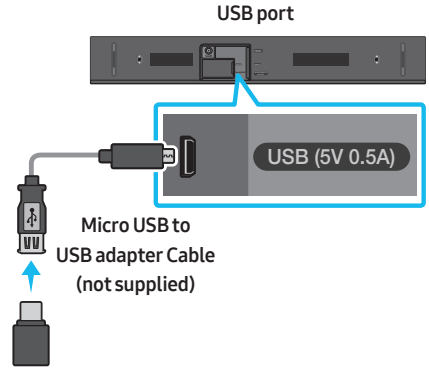

If an update is offered, you can update the firmware by connecting a USB device with the firmware update stored on it to the USB port on your Soundbar.

For more information about how to download update files, go to the Samsung Electronics website at (www.samsung.com → Support).

Then, enter or select the model number of your Soundbar, select the Software & Apps option, and then Downloads. Note that the option names can vary.

Updating Procedure

1. Connect a Micro USB to USB adapter cable with a male USB 2.0 Micro USB plug (Type B) on one end and a standard female 2.0 USB jack (Type A) on the other end to the micro USB jack on your Soundbar.
 - The Micro USB to USB adapter cable is sold separately. To purchase, contact a Samsung Service Center or Samsung Customer Care.
2. Follow the steps below to download the product software:
Go to the Samsung website at (samsung.com) → search for the model name
- select the customer support option (the option name is subject to change)
3. Save the downloaded software to a USB stick and select “Extract Here” to unzip the folder.
4. Turn off the Soundbar and connect the USB stick containing the software update to the female port on a Micro USB adapter cable. Connect the cable to the USB port on the Soundbar.
5. Turn on the Soundbar. Within 3 minutes, “**UPDATE**” is displayed and updating begins.
6. When the update finishes, the Soundbar turns off. Press the ►|| button on the remote control for 5 seconds. “**INIT**” appears on the display and then the Soundbar turns off. The update is complete.
 - This product has a DUAL BOOT function. If the firmware fails to update, you can update the firmware again.

If UPDATE is not displayed

1. Turn off the Soundbar, disconnect and then reconnect the USB storage device that contains the update files to the Soundbar’s USB port.
2. Disconnect the Soundbar’s power cord, reconnect it, and then turn on the Soundbar.
 - Updating firmware may not work properly if audio files supported by the Soundbar are stored in the USB storage device.
 - Do not disconnect the power or remove the USB device while updates are being applied. The main unit will turn off automatically after completing the firmware update.
 - After update is completed, the user setup in Soundbar is initialized. We recommend you write down your settings so that you can easily reset them after the update. If the software update fails, check if the USB stick is defective.
 - Mac OS users should use MS-DOS (FAT) as the USB format.
 - Updating via USB may not be available, depending on the USB storage device manufacturer.

11 TROUBLESHOOTING

Refer to the table below if this product does not function properly. If the problem you are experiencing is not listed below or if the instructions below do not help, turn off the product, disconnect the power cord, and contact Samsung Electronics at 1-800-SAMSUNG (1-800-726-7864).

The unit will not turn on.

Is the power cord plugged into the outlet?

- Connect the power plug to the outlet.

A function does not work when the button is pressed.

Is there static electricity in the air?

- Disconnect the power plug and connect it again.

Sound dropouts occur in BT mode.

- See the Bluetooth connection sections on pages 8 and 14.

Sound is not produced.

Is the Mute function on?

- Press the **VOL** button to cancel the function.

Is the volume set to minimum?

- Adjust the Volume.

The remote control does not work.

Are the batteries drained?

- Replace with new batteries.

Is the distance between the remote control and Soundbar main unit too far?

- Move the remote control closer to the Soundbar main unit.
-

12 LICENSE



Manufactured under license from Dolby Laboratories. Dolby, Dolby Audio, Pro Logic, and the double-D symbol are trademarks of Dolby Laboratories.



For DTS patents, see <http://patents.dts.com>. Manufactured under license from DTS Licensing Limited. DTS, the Symbol, DTS in combination with the Symbol, and DTS 2.0 Channel are registered trademarks or trademarks of DTS, Inc. in the United States and/or other countries. © DTS, Inc. All Rights Reserved.



The terms HDMI and HDMI High-Definition Multimedia Interface, and the HDMI Logo are trademarks or registered trademarks of HDMI Licensing LLC in the United States and other countries.

13 OPEN SOURCE LICENSE NOTICE

To send inquiries and requests regarding open sources, contact Samsung via Email (oss.request@samsung.com).

14 IMPORTANT NOTES ABOUT SERVICE

- Figures and illustrations in this User Manual are provided for reference only and may differ from actual product appearance.
- An administration fee may be charged if either:
 - a. An engineer is called out to your home at your request and there is no defect in the product.
 - b. You bring the unit to a repair center and there is no defect in the product.
- You will be advised of the amount of the administration fee before any work is done or a home visit is made.
- If you have a problem with this product, we strongly recommend you read the appropriate section of this manual, visit the Support page for your product at www.samsung.com, or call Samsung Product Support (1-800-726-7864) to find an answer before you contact a service center for a repair.

15 SPECIFICATIONS AND GUIDE

Specifications

GENERAL	USB	5V/0.5A
	Weight	6.6 lbs (3.0 kg)
	Dimensions (W x H x D)	25.2 x 2.8 x 3.9 inches (640.0 x 71.0 x 100.3 mm)
	Operating Temperature Range	+41°F to +95°F (+5°C to +35°C)
	Operating Humidity Range	10 % ~ 75 %
Supported play formats (DTS 2.0 sound is played in DTS format.)		LPCM 2ch, Dolby Audio™ (supporting Dolby® Digital), DTS

NOTES

- Samsung Electronics Co., Ltd reserves the right to change the specifications without notice.
- Weight and dimensions are approximate.
- Dispose unwanted electronics through an approved recycler.
To find the nearest recycling location, go to our website: www.samsung.com/recyclingdirect or call (877) 278 - 0799

LIMITED WARRANTY TO ORIGINAL PURCHASER

This SAMSUNG brand product, as supplied and distributed by SAMSUNG and delivered new, in the original carton to the original consumer purchaser, is warranted by SAMSUNG against manufacturing defects in materials and workmanship for a limited warranty period of:

One (1) Year Parts and Labor* **(*90 Days Parts and Labor for Commercial Use)**

This limited warranty begins on the original date of purchase, and is valid only on products purchased and used in the United States. To receive warranty service, the purchaser must contact SAMSUNG for problem determination and service procedures. Warranty service can only be performed by a SAMSUNG authorized service center. The original dated bill of sale must be presented upon request as proof of purchase to SAMSUNG or SAMSUNG's authorized service center. Transportation of the product to and from the service center is the responsibility of the purchaser. SAMSUNG will repair or replace this product, at our option and at no charge as stipulated herein, with new or reconditioned parts or products if found to be defective during the limited warranty period specified above. All replaced parts and products become the property of SAMSUNG and must be returned to SAMSUNG. Replacement parts and products assume the remaining original warranty, or ninety (90) days, whichever is longer. SAMSUNG's obligations with respect to software products distributed by SAMSUNG under the SAMSUNG brand name are set forth in the applicable end user license agreement. Non-SAMSUNG hardware and software products, if provided, are on an "AS IS" basis.

Non-SAMSUNG manufacturers, suppliers, publishers, and service providers may provide their own warranties. This limited warranty covers manufacturing defects in materials and workmanship encountered in normal, and except to the extent otherwise expressly provided for in this statement, noncommercial use of this product, and shall not apply to the following, including, but not limited to: damage which occurs in shipment; delivery and installation; applications and uses for which this product was not intended; altered product or serial numbers; cosmetic damage or exterior finish; accidents, abuse, neglect, fire, water, lightning or other acts of nature; use of products, equipment, systems, utilities, services, parts, supplies, accessories, applications, installations, repairs, external wiring or connectors not supplied and authorized by SAMSUNG, or which damage this product or result in service problems; incorrect electrical line voltage, fluctuations and surges; customer adjustments and failure to follow operating instructions, cleaning, maintenance and environmental instructions that are covered and prescribed in the instruction book; product removal or reinstallation; reception problems and distortion related to noise, echo, interference or other signal transmission and delivery problems. SAMSUNG does not warrant uninterrupted or error-free operation of the product.

THERE ARE NO EXPRESS WARRANTIES OTHER THAN THOSE LISTED AND DESCRIBED ABOVE, AND NO WARRANTIES WHETHER EXPRESS OR IMPLIED, INCLUDING, BUT NOT LIMITED TO, ANY IMPLIED WARRANTIES OF MERCHANTABILITY OR FITNESS FOR A PARTICULAR PURPOSE, SHALL APPLY AFTER THE EXPRESS WARRANTY PERIODS STATED ABOVE, AND NO OTHER EXPRESS WARRANTY OR GUARANTY GIVEN BY ANY PERSON, FIRM OR CORPORATION WITH RESPECT TO THIS PRODUCT SHALL BE BINDING ON SAMSUNG. SAMSUNG SHALL NOT BE LIABLE FOR LOSS OF REVENUE OR PROFITS, FAILURE TO REALIZE SAVINGS OR OTHER BENEFITS, OR ANY OTHER SPECIAL, INCIDENTAL OR CONSEQUENTIAL DAMAGES CAUSED BY THE USE, MISUSE OR INABILITY TO USE THIS PRODUCT, REGARDLESS OF THE LEGAL THEORY ON WHICH THE CLAIM IS BASED, AND EVEN IF SAMSUNG HAS BEEN ADVISED OF THE POSSIBILITY OF SUCH DAMAGES. NOR SHALL RECOVERY OF ANY KIND AGAINST SAMSUNG BE GREATER IN AMOUNT THAN THE PURCHASE PRICE OF THE PRODUCT SOLD BY SAMSUNG AND CAUSING THE ALLEGED DAMAGE. WITHOUT LIMITING THE FOREGOING, PURCHASER ASSUMES ALL RISK AND LIABILITY FOR LOSS, DAMAGE OR INJURY TO PURCHASER AND PURCHASER'S PROPERTY AND TO OTHERS AND THEIR PROPERTY ARISING OUT OF THE USE, MISUSE OR INABILITY TO USE THIS PRODUCT SOLD BY SAMSUNG NOT CAUSED DIRECTLY BY THE NEGLIGENCE OF SAMSUNG. THIS LIMITED WARRANTY SHALL NOT EXTEND TO ANYONE OTHER THAN THE ORIGINAL PURCHASER OF THIS PRODUCT, IS NONTRANSFERABLE AND STATES YOUR EXCLUSIVE REMEDY.

Some states do not allow limitations on how long an implied warranty lasts, or the exclusion or limitation of incidental or consequential damages, so the above limitations or exclusions may not apply to you. This warranty gives you specific legal rights, and you may also have other rights which vary from state to state.

To obtain warranty service, please contact SAMSUNG customer care center.

The benefits of this Limited Warranty extend only to the original purchaser of Samsung products from an authorized Samsung reseller. THIS LIMITED WARRANTY SHALL NOT APPLY TO ANY SAMSUNG PRODUCTS PURCHASED FROM UNAUTHORIZED RESELLERS OR RETAILERS, EXCEPT IN STATES WHERE SUCH RESTRICTION MAY BE PROHIBITED. For a list of Samsung authorized retailers, please go to:
http://www.samsung.com/us/peaceofmind/authorized_resellers.html.

SAMSUNG

The party responsible for product compliance:
Samsung Electronics Co., LTD.
America QA lab of Samsung
19 Chapin Rd. Building D,
Pine Brook, New Jersey 07058

QUESTIONS OR COMMENTS?

COUNTRY	CALL	OR VISIT US ONLINE AT	WRITE
IN THE US	1-800-SAMSUNG (726-7864)	www.samsung.com/us/support	Samsung Electronics America, Inc. 85 Challenger Road Ridgefield Park, NJ 07660

© 2018 Samsung Electronics Co., Ltd. All rights reserved.