

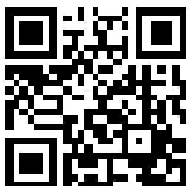

**BEHIND EVERY GREAT MEAL**

# **USER GUIDE**



A commitment to:



**Countries of destination:**

GB - Great Britain

IE - Ireland

DE - Germany

ES - Spain

FR - France

IT - Italy

PL - Poland

NL - Netherlands

SE - Sweden

CN - China

NZ - New Zealand

AU - Australia

To contact Belling about your appliance, please call:



**Customer Care Helpline**

**0344 815 3746**

In case of difficulty within the UK



**Warranty Registration**

**0800 952 1068**

\*Please call our Customer Care team for extended warranty



**Spares Store**

**0344 815 3745**



To register your appliance online:

**[www.belling.co.uk](http://www.belling.co.uk)**



To contact us by email:

**[gdhainfo@gdha.com](mailto:gdhainfo@gdha.com)**



To register your appliance by mail:

**Please complete the warranty card and return to the address supplied**



Alternatively general, spares and service information is available from our website at: **[www.belling.co.uk](http://www.belling.co.uk)**

Calls are charged at the basic rate, please check with your telephone service provider for exact charges

Your new appliance comes with our **12-month guarantee**, protecting you against electrical and mechanical breakdown. To register, please complete the registration form included, register online or by phone. For full terms & conditions of the manufacturer's guarantee, please refer to the website above. In addition, you may wish to purchase an extended warranty. A leaflet explaining how to do this is included with your appliance.

Our policy is one of constant development and improvement, therefore we cannot guarantee the strict accuracy of all of our illustrations and specifications. Changes may have been made subsequent to publishing.

# INTRODUCTION

---

Thank you for buying this British-built appliance from us.

This user guide book is designed to help you through each step of owning your new product.

Please read it carefully before you start using your appliance, as we have endeavored to answer as many questions as possible, and provide you with as much support as we can.

General information, spares and service information is available from our website.

If you should find something missing from your product or have any questions that are not covered in this user guide, please contact us (see contact information inside the front cover).

## European Directives

As a producer and a supplier of cooking appliances we are committed to the protection of the environment and are in compliance with the WEEE directive. All our electric products are labelled accordingly with the crossed out wheeled bin symbol. This indicates, for disposal purposes at end of life, that these products must be taken to a recognized collection points, such as local authority sites/local recycling centres.



This appliance Complies with European Community Directives (CE) for household and similar electrical appliances and Gas appliances where applicable.

This appliance conforms to European Directive regarding Eco design requirements for energy-related products. Our policy is one of constant development and improvement, therefore we cannot guarantee the strict accuracy of all of our illustrations and specifications - changes may have been made subsequent to publishing.

## Disposal of Packaging Material

The packaging materials used with this appliance can be recycled. Please dispose of the packaging materials in the appropriate container at your local waste disposal facilities.

### **UK ONLY GAS WARNING:**

If you smell gas, Do not try to light any appliance. Do not touch any electrical switch.  
Call the Gas Emergency Help line at **0800 111999**

# **SAFETY**

---

## **WARNING**

- During use the appliance becomes hot. Care should be taken to avoid touching heating elements.
- The appliance and its accessible parts become hot during use. Care should be taken to avoid touching heating elements. Children less than 8 years of age shall be kept away unless continuously supervised. This appliance can be used by children aged from 8 years and above and persons with reduced physical sensory or mental capabilities or lack of experience and knowledge if they have been given supervision or instruction concerning the use of the appliance in a safe way and understand the hazards involved. Children shall not play with the appliance. Cleaning and user maintenance shall not be made by children without supervision.
- Do not use harsh abrasive cleaners or sharp metal scrapers to clean the oven door glass since they can scratch the surface, which may result in shattering of the glass.
- Do not use a steam cleaner on any cooking range, hob or oven appliance.
- If your appliance is fitted with a lid, any spillage should be removed from the lid before opening. The hob surface should be allowed to cool before closing the lid.
- Ensure that the appliance is switched off before replacing the lamp to avoid electric shock.
- The appliance is not intended to be operated by means of an external timer or separate control system.
- Unattended cooking on a hob with fat or oil can be dangerous and may result in fire.
- NEVER try to extinguish a fire with water, but switch off the appliance and then cover the flame with a lid or damp cloth.
- Danger of fire: Do not store items on the cooking surfaces.
- Only use hob guards designed by the manufacturer of the cooking appliance or indicated by the manufacturer of the appliance in the instructions for use as suitable or hob guards incorporated in the appliance. The use of inappropriate hob guards can cause accidents.
- Accessible parts may become hot when the grill is in use. Children

should be kept away.

## CAUTION

- This appliance must not be installed behind a decorative door in order to avoid overheating.
- The cooking process has to be supervised. A short term cooking process has to be supervised continuously.
- The use of a gas cooking appliance results in the production of heat, moisture and products of combustion in the room in which it is installed. Ensure that the kitchen is well ventilated especially when the appliance is in use: keep natural ventilation holes open or install a mechanical ventilation device (mechanical extractor hood). Prolonged intensive use of the appliance may call for additional ventilation, for example opening of a window, or more effective ventilation, for example increasing the level of mechanical ventilation where present.
- This appliance is for cooking purposes only. It must not be used for other purposes, for example room heating.
- (Gas through glass models only) In case of hotplate glass breakage, immediately shut off all burners and any electrical heating element and isolate the appliance from the power supply, do not touch the appliance surface, do not use the appliance.

- **Fire Safety Advice**

If you do have a fire in the kitchen, don't take any risks - get everyone out of your home and call the Fire Brigade.

**If you have an electrical fire in the kitchen and you consider it safe to do so:**

- Pull the plug out, or switch off the power at the fuse box - this may be enough to stop the fire immediately
- Smother the fire with a fire blanket, or use a dry powder or carbon dioxide extinguisher
- Remember: never use water on an electrical or cooking oil fire.

- **Other Safety Advice**

- Servicing should be carried out only by authorised personnel.
- Do not operate the appliance without the glass panel correctly fitted.
- There is a risk of electric shock, so always make sure you have turned off and unplugged your appliance before starting. Always allow the product to cool down before you change a bulb.
- Do not modify the outer panels of this appliance in any way.
- This appliance must be earthed.
- The appliance must never be disconnected from the mains supply during use, as this will seriously affect the safety and performance, particularly in relation to surface temperatures becoming hot and gas operated parts not working efficiently. The cooling fan (if fitted) is designed to run on after the control knob has been switched off.
- **GAS WARNING!** - If you smell gas: Do not try to light any appliance, Do not touch any electrical switch. Contact your local gas supplier immediately.

# USING YOUR APPLIANCE

---

## Getting to know your product

**Note:** Your appliance layout may differ depending on the model.

### Hob 90cm

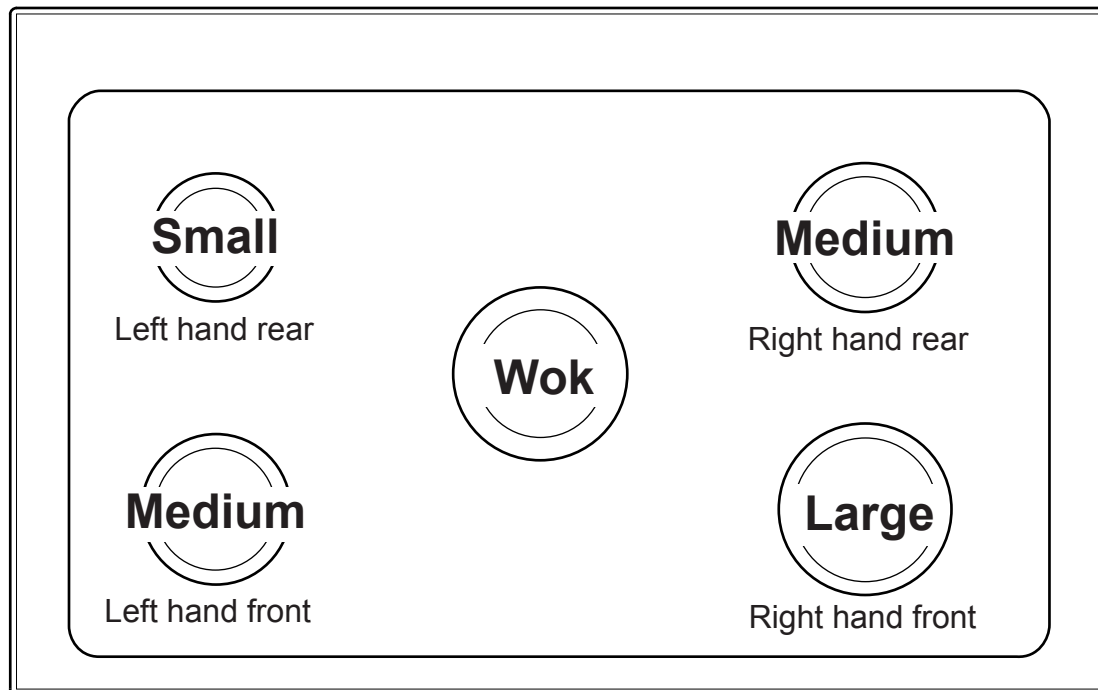

### Hob 100/110cm

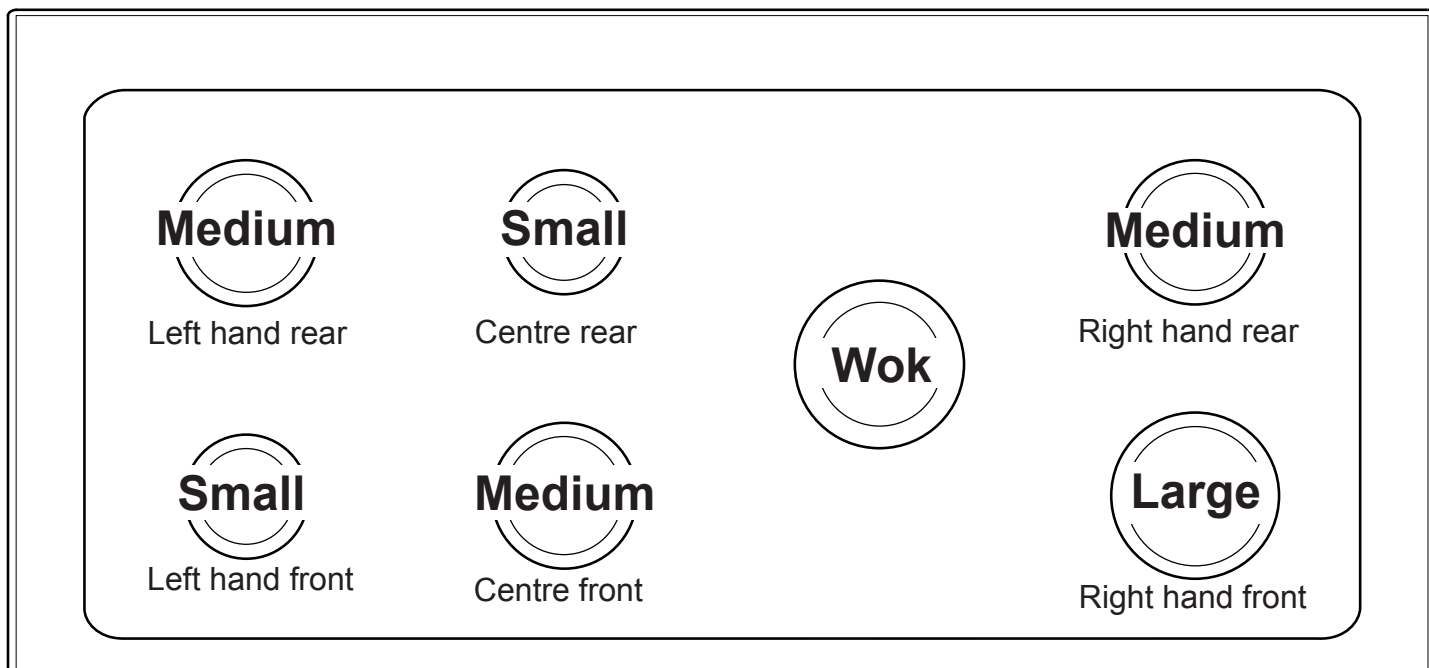

## Control Panel

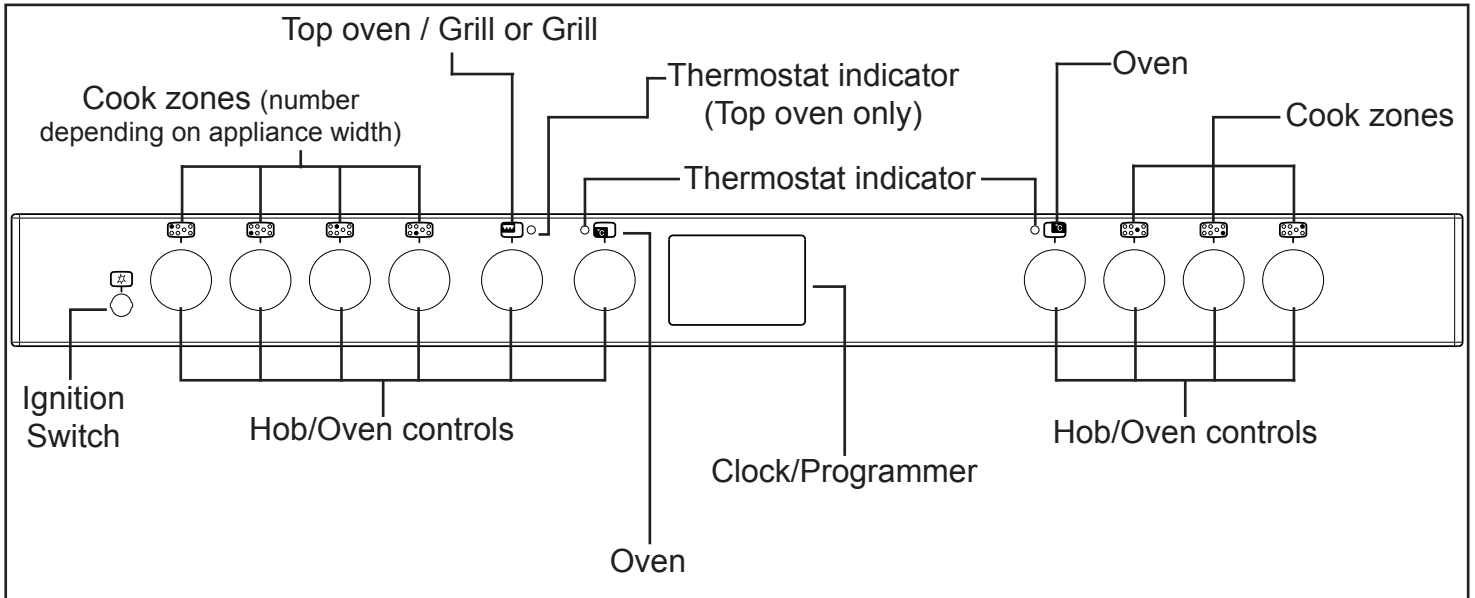

## Control Panel (90cm MF only)

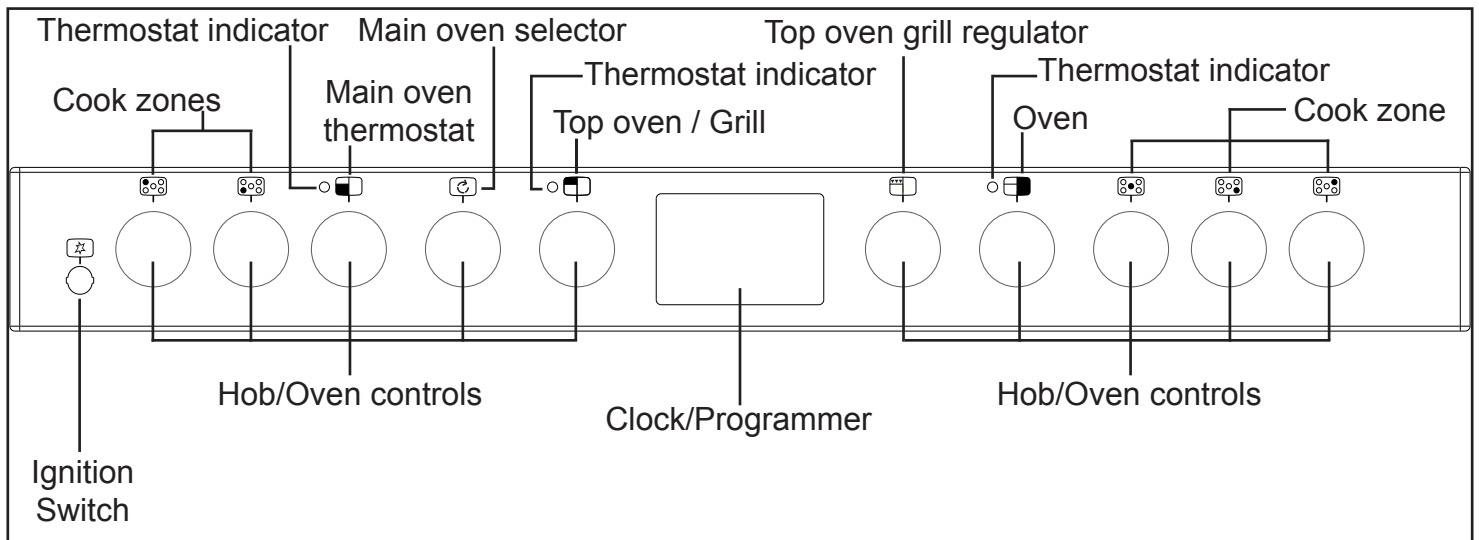

# Appliance functions

**Note:** Your oven may not have all of the functions shown here. We recommend for best cooking results, please preheat your oven for 15 minutes and 3-5 minutes for grilling.

Do not try to slow cook using any of the other oven functions.



Intense Baking



Base Heat with fan



Slow Cook



Fanned Grill



Oven Selector Control



Conventional Grill

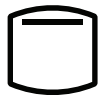

Top Heat



Lights only



Defrost

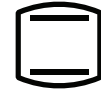

Conventional Oven



Fanned Oven

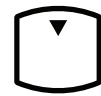

Low Grill



Single Grill



Dual Grill

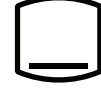

Base Heat

## Single grill

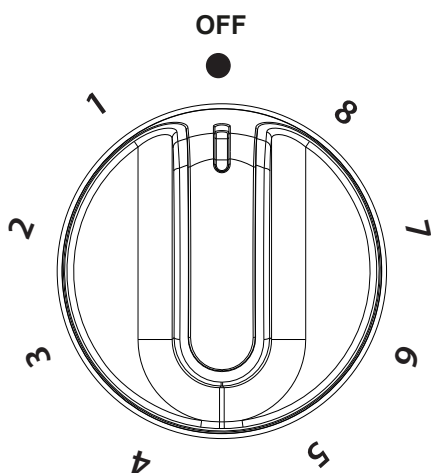

## Dual Grill

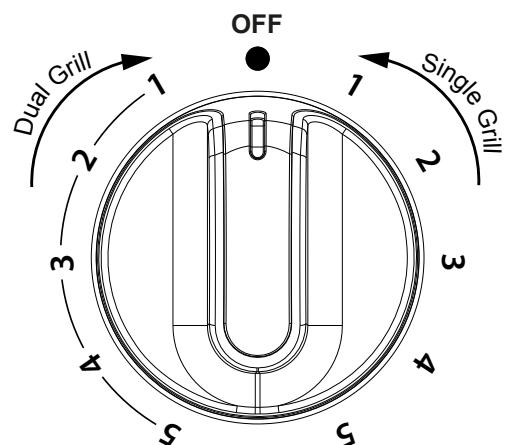



## Top oven/Grill

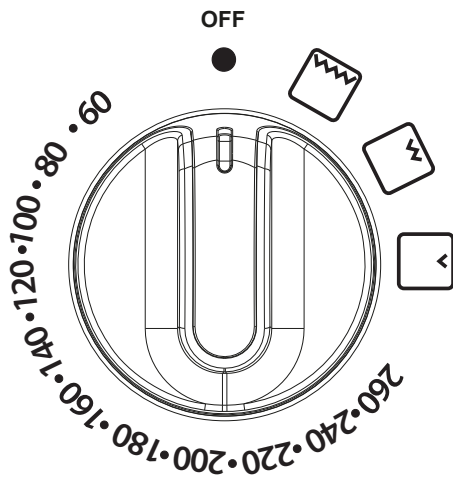

## Oven

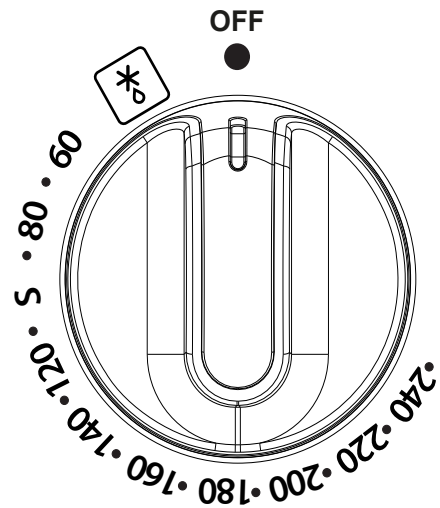

## Oven/Grill

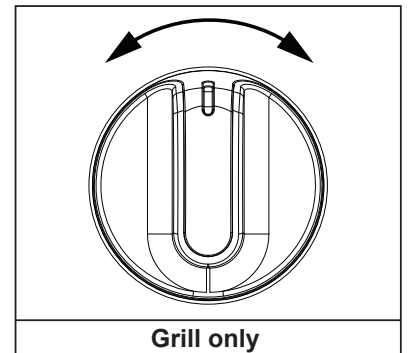
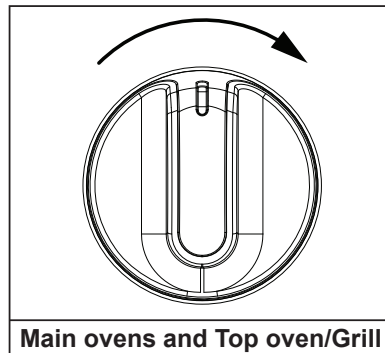
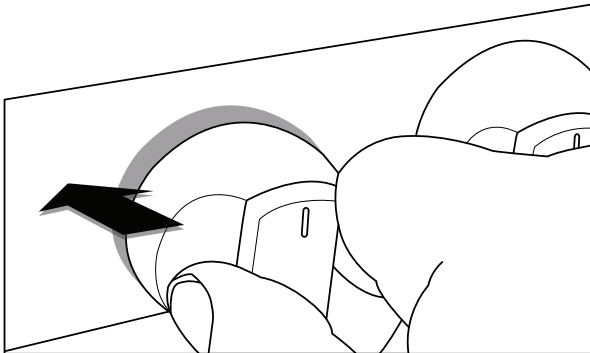

When using the top oven or main oven, the red thermostat indicator will come on until the selected temperature is reached.

When the top oven/grill or grill is switched on, the cooling fans come on to keep the fascia and control knobs cool during cooking/grilling. The cooling fans may operate when the main ovens are in use, depending on the temperature setting. The fans may continue to operate for a period after the ovens/grill have been switched off. During use the fan may cycle on and off, this is normal.

The 90cm left hand main oven and the 100/110cm right hand oven will not operate if the programmer is set to Auto. See clock/programmer section.

**Important:** Never put items directly on the base of the oven, or cover the oven base with foil, as this may cause the element to overheat. Always position items on the shelf.

# Grill

THE DOOR **MUST** BE OPEN WHEN THE GRILL IS USED FOR CONVENTIONAL GRILLING.

## Grill pan, trivet and detachable grill pan handle

The grill trivet, inside the grill pan, can be inverted to give a high or low position, or it may be removed. The speed of grilling can be controlled by selecting a higher or lower shelf position, or adjusting the grill setting.

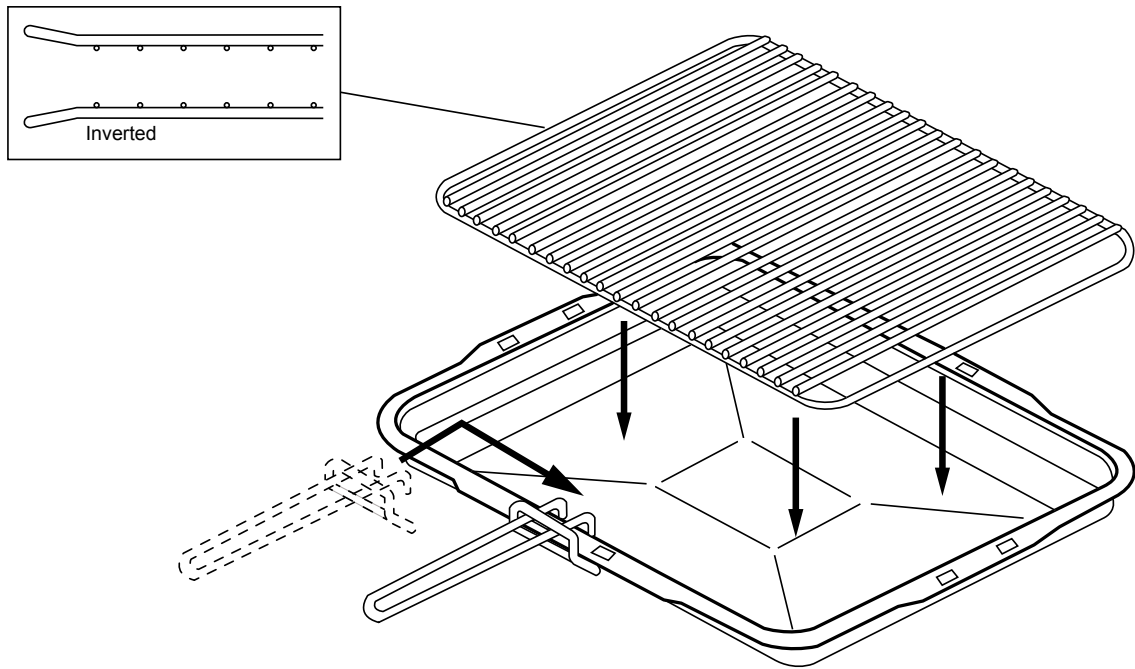

# Hob

- Hold the control knob in for up to 15 seconds then release. For the wok (if fitted), please allow the burner to warm up for a few minutes.
- Once lit, turn the control knob to the required setting.

If the burner fails to ignite within this time, release the control knob and wait 1 minute before attempting to re-ignite.

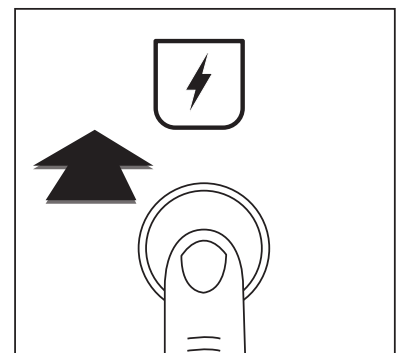
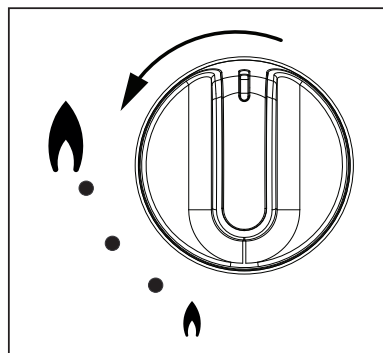
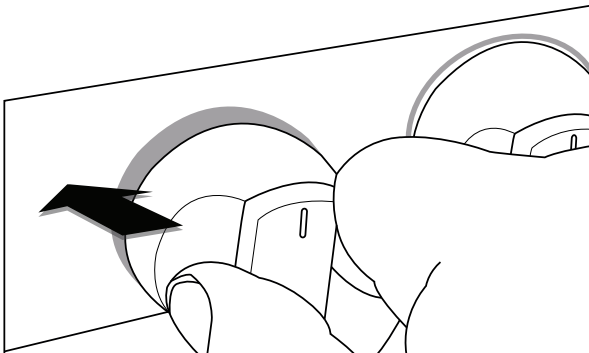

## Fitting burner caps and heads (Gas Hobs)

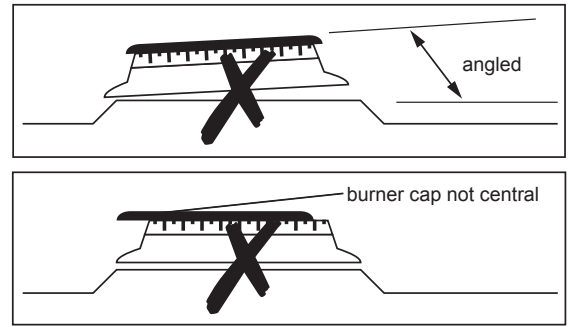
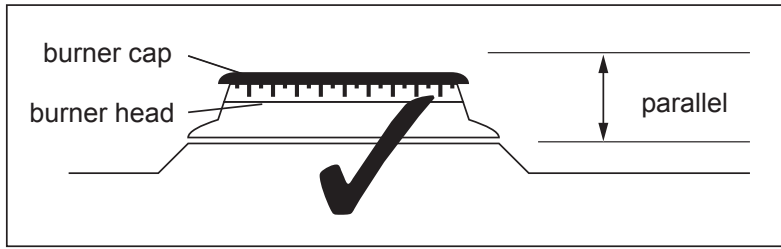

## Pan placement

Always make sure that your pans are placed centrally on the burners and do not allow the flame to extend over the base of the pan.

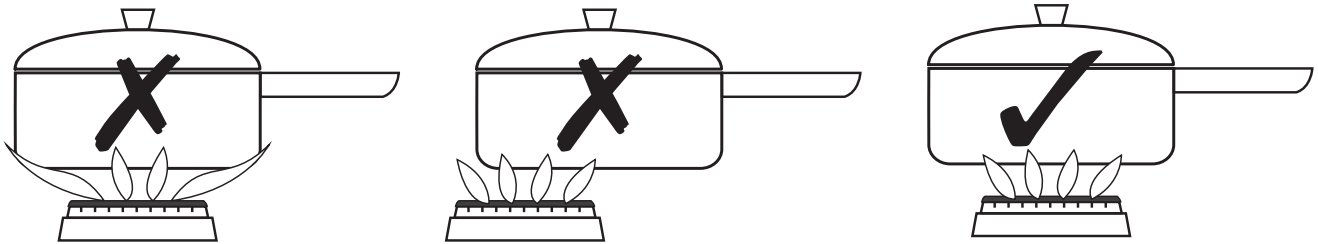

## Pan sizes required

Hob Cook Zones	Minimum Pan Sizes (mm)	Maximum Pan Sizes (mm)
Rapid & Wok	100	260
All other cook zones		250





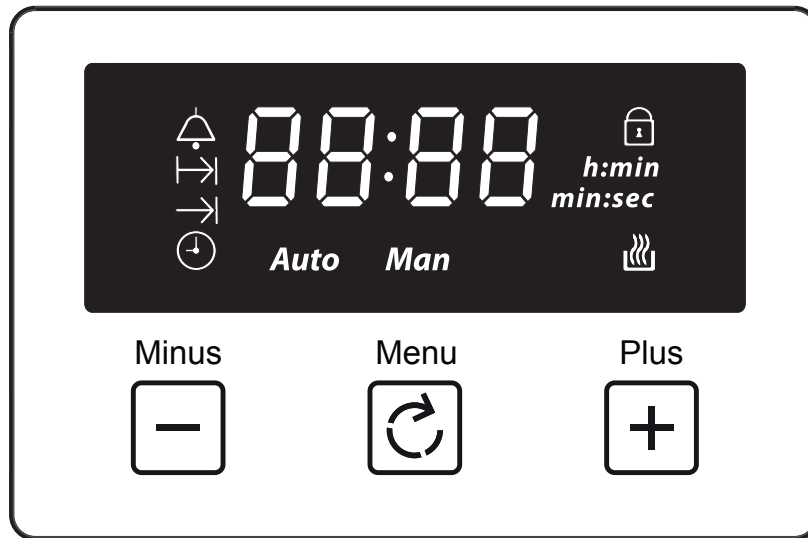

**Warning:** Do not allow cooking vessels to overlap cooking zones

Please be aware that only the main oven is controlled by the programmer.

## Clock / Programmer

**Note:** Your clock / programmer may not have all these functions



	Minute minder	<b>Man</b>	Manual mode
	Cooking time / Duration	L 1, L 2, L 3	Volume level
	End of cooking time	23:59	7-segment display
	Time of day	99:00	Max. adjustable minute minder
	Keylock	23:59	Max. adjustable cooking time
	Auto cooking	<b>h:min</b>	Display hours:minutes
<b>Auto</b>	Automatic mode	<b>min:sec</b>	Display minutes:seconds

### Using the touch controls

Menu - Scroll through to select a function

Plus - Increase time or volume

Minus - Decrease time or volume

When a function is selected and the time or volume is set, the chosen function will automatically start seven seconds after setting.

### Manual Mode

If the programmer is not in semi-automatic or full-automatic mode you can use oven functions manually. The manual icon is also on the display.

## Setting the time of day

By pressing menu, scroll through the functions until you reach 'time of day'.

**1**

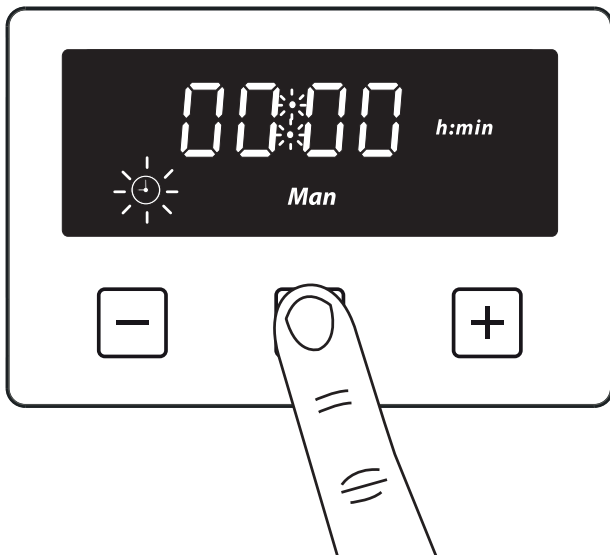

**2**

Press the plus or minus buttons to set a time

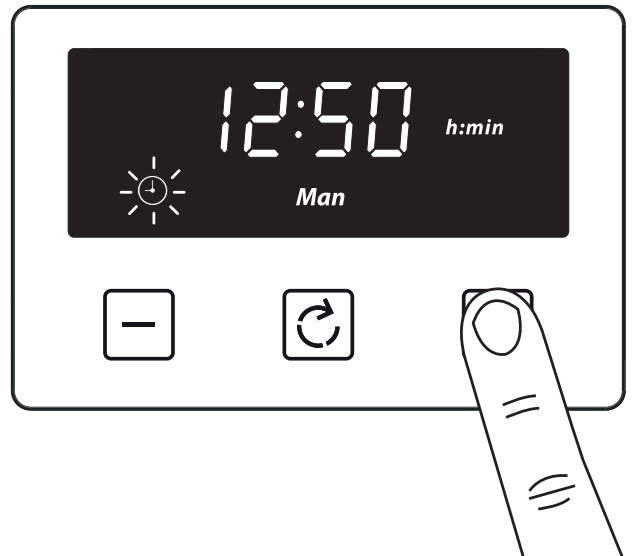

## Setting the minute minder

The maximum cooking time that can be set is 99 minutes.

**1**

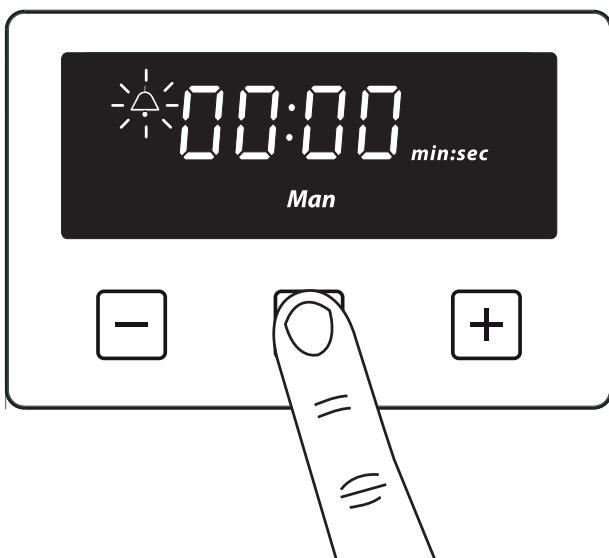

**2**

Press the plus or minus buttons to set a time

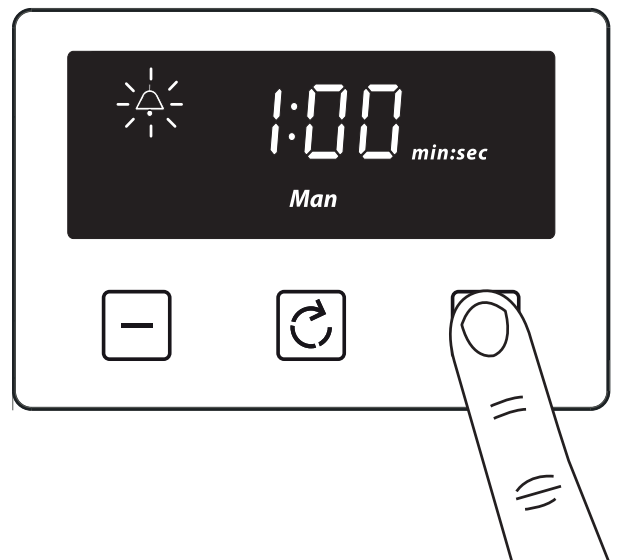

Once set, the minute minder will start to countdown in steps of seconds. The display will show the minute minder symbol and the remaining time. The countdown will continue in the background, if other functions are being set.

When the set time for the minute minder has completed, an alarm is heard and the minute minder symbol will flash on the display. Press any button to stop the alarm and the time of day is displayed.

## To modify or cancel the minute minder

Return to the minute minder function and use either the plus or minus buttons to adjust the time. By setting the time to '0.00', this will cancel the countdown.

## Setting the cooking time (the duration of time the oven will operate for)

The maximum cooking time that can be set is 23 hours and 59 minutes.

**1**

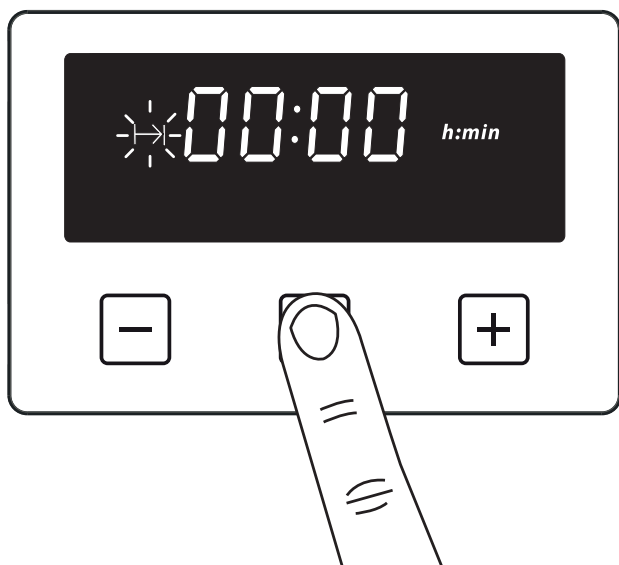

**2**

Press the plus or minus buttons to set a time



Once set, the automatic mode, auto cooking symbol and the time of day is displayed.

When cooking is completed, an alarm is heard and the manual mode symbol flashes on the display. Press the Menu button to stop the alarm and then the 'time of day' will then be displayed. Pressing the Menu button again will return to manual mode.

## To modify or cancel the cooking time

Return to the 'cooking time' function and use either the plus or minus buttons to set the time. By setting the time to '0.00', this will cancel the countdown.

## Setting the end of cooking time (to set a time for the oven to turn off)

The display shows the current 'time of day' plus the 'end of cooking time' symbol. The latest 'end of cooking time' is limited to the current 'time of day' plus the maximum time that can be set (23 hours and 59 minutes).

**1**



**2**

Press the plus or minus buttons to set a time

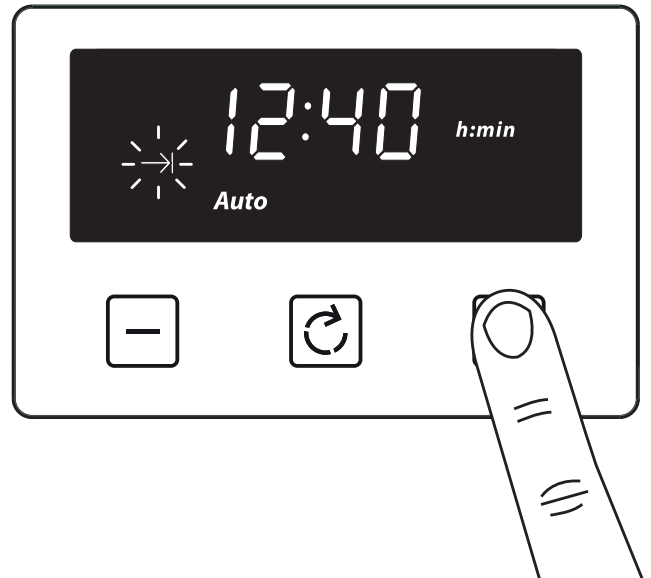

The auto cooking symbol disappears from the display once the time, the required cooking settings and temperature have been set. The appliance will not be switched on until the set cooking start time, that is the difference between the cooking end time and the cooking duration.

When cooking is completed, an alarm is heard and manual mode symbol flashes on the display. Press the menu button to stop the alarm. Pressing the Menu button again will return to manual mode.

### To modify or cancel the end of cooking time

Return to the 'end of cooking time' function and use either the plus or minus buttons to set the time. The 'end of cooking time' can be deleted by counting back using the minus button until it equals the current time of day.

## Setting the volume

Press the menu button until "LX" (X = 1, 2 or 3) flashes on the display. Use the plus or minus buttons to select a tone.

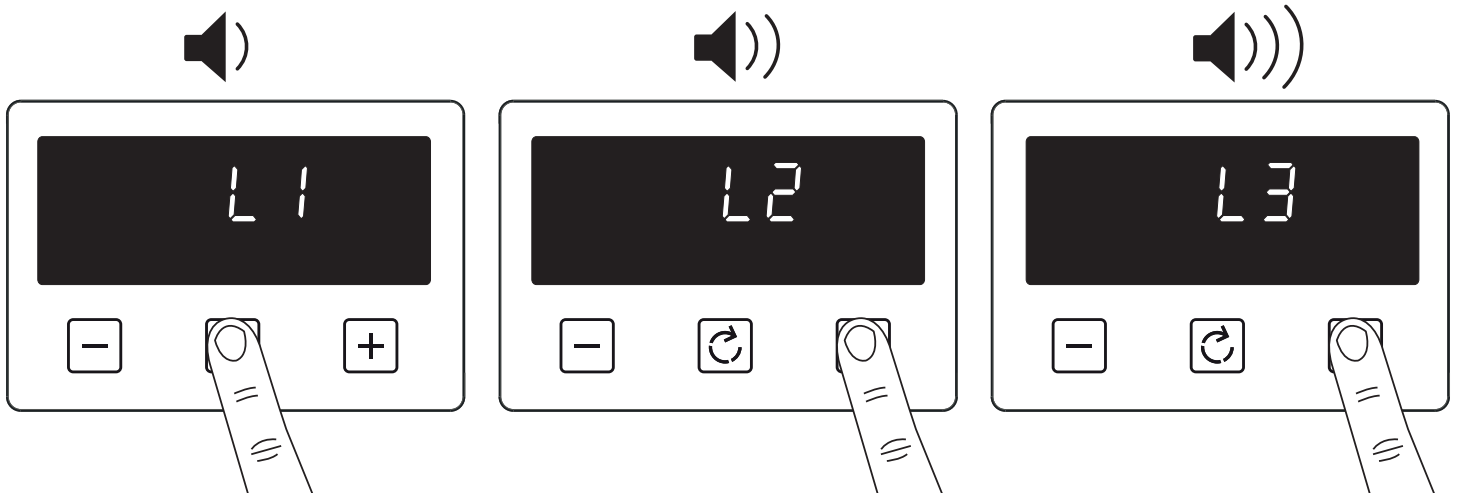

**Note:** Default tone is L3

## Activating / deactivating Key lock

**1** Press and hold the plus button for 3-5 seconds

**2**

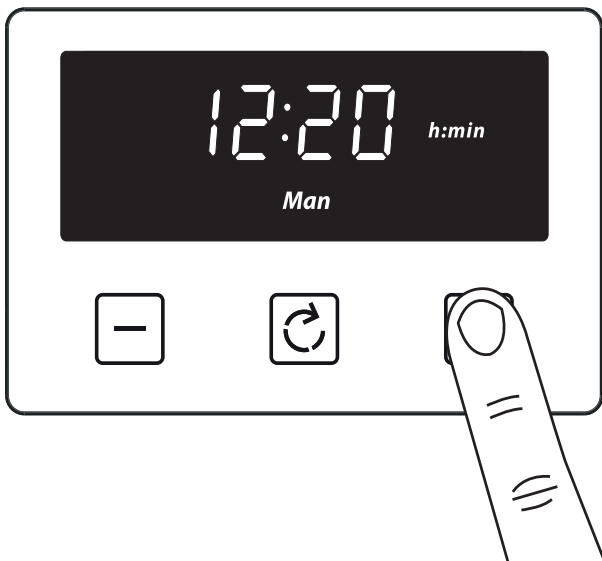

Once the Key lock is active, the buttons will be inactive. A two beep signal will be heard if the buttons are pressed.

## To deactivate the Key lock

Press and hold the plus button for 3-5 seconds. The Key lock symbol will disappear and the appliance can continue to be used.

**Note:** In case of main power loss for a short time (about 1.5 minutes), timer maintains its status. Key lock status and buzzer tone are memorized independent of the power loss duration.



## Removing Shelf Runners

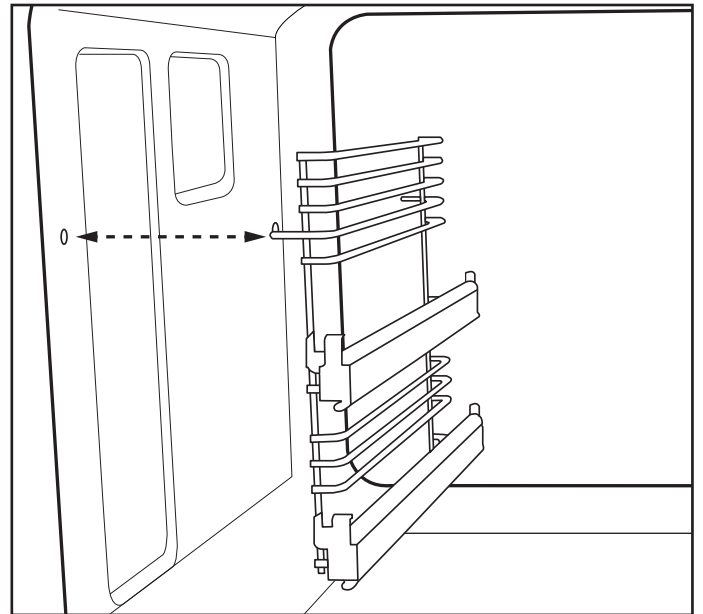
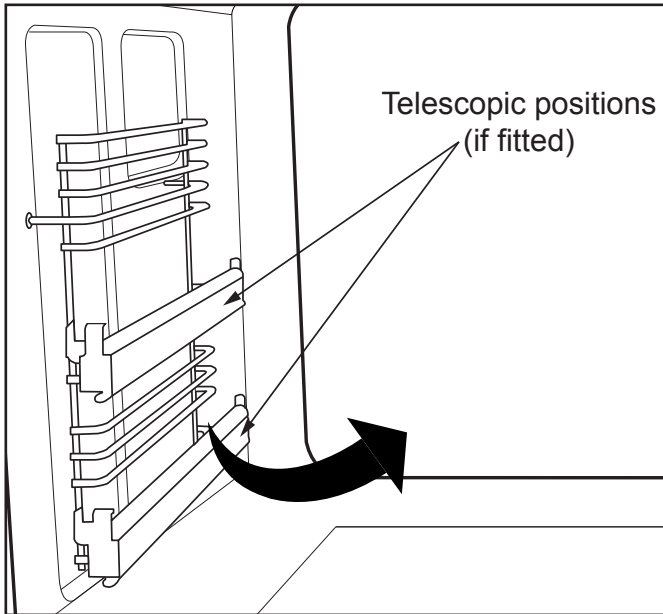

## Standard shelves

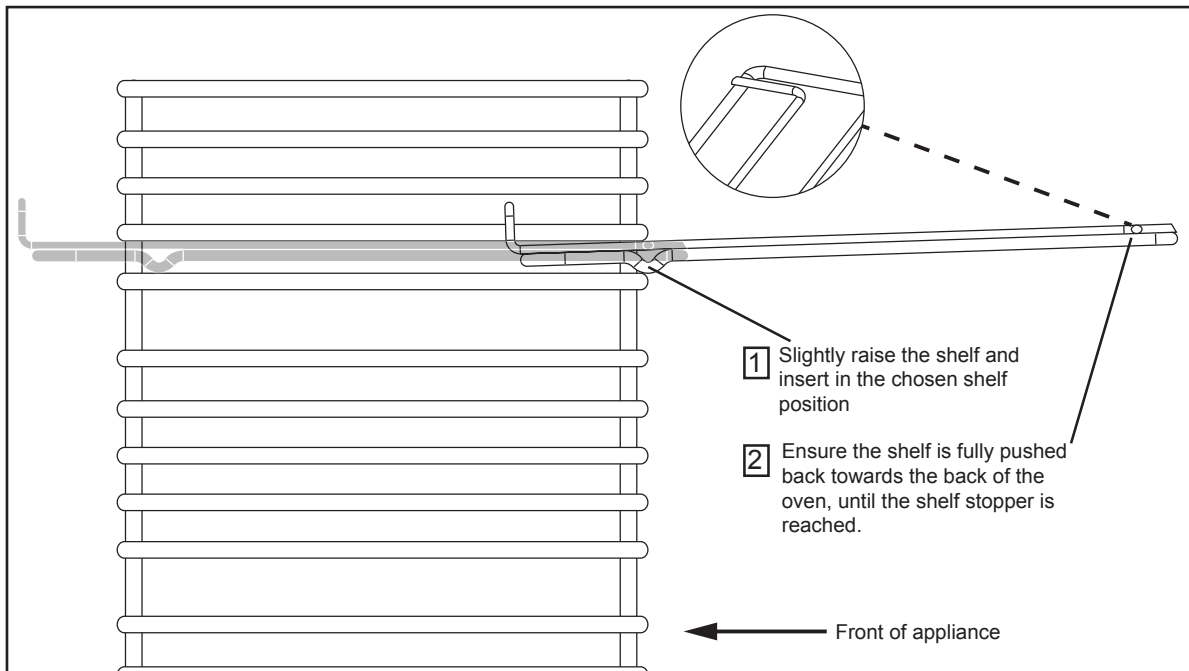

## Removing Telescopic shelves (if fitted)

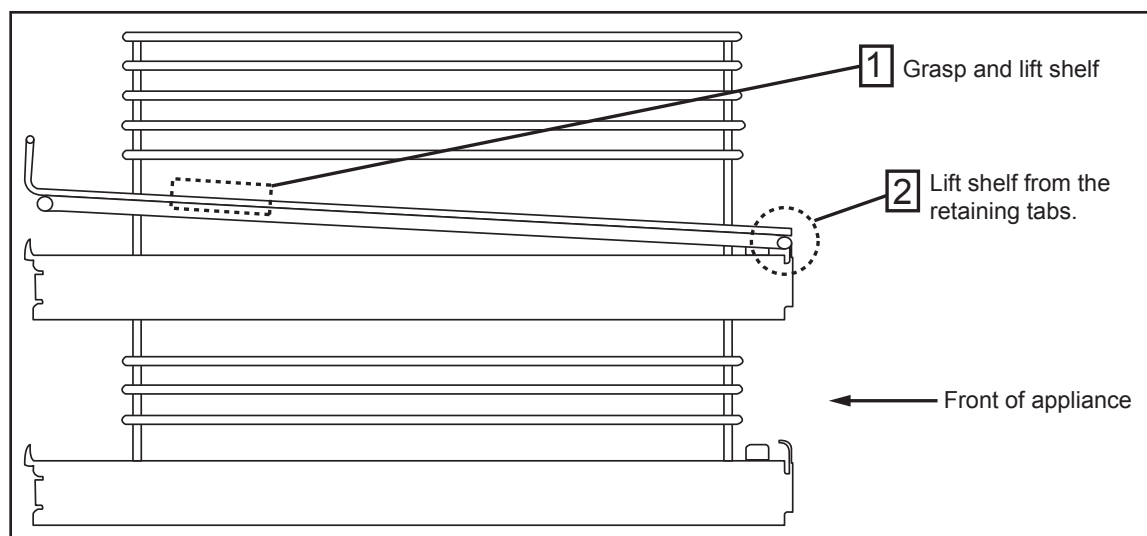

Before removing the shelves completely, please make sure that the shelf is unclipped from the retaining tabs.

## Changing the light bulb

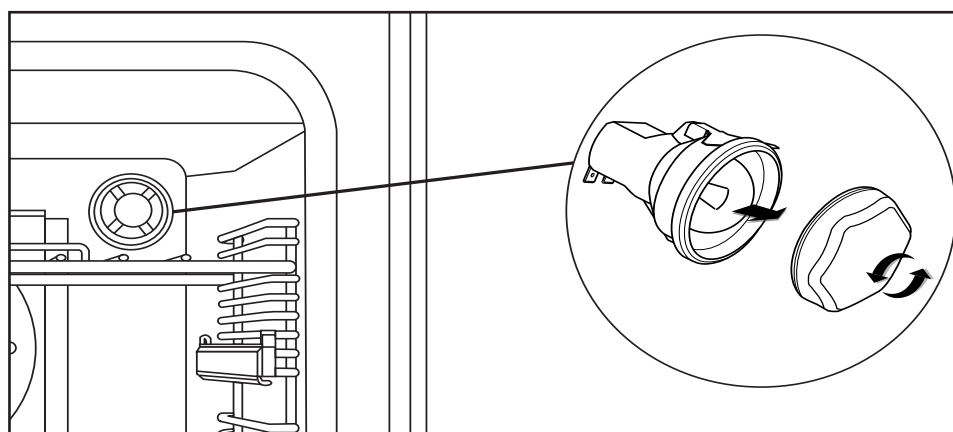

Not all appliances have the same number and type of bulbs. Before you replace your bulb, check to see what type you have. **Please remember that bulbs are not covered by your warranty.**

## **Additional features**

### **Fold Down Lid (if fitted)**

**Caution:** Glass lids may shatter when heated. Turn off all the burners before shutting the lid.

- The lid must be opened fully, so there is no danger of it closing while the hob is being used.
- The appliance is fitted with a safety system, which will automatically turn off the hotplate burners if they are inadvertently left on as the lid is closed.
- The lid is not intended to be used as a work surface, as it becomes hot when any part of the cooker is in use. The surface may be scratched if items with rough or sharp surfaces are placed on it.
- Always allow the hob surface to cool before closing the lid.

### **Wok Ring (if supplied)**

**The wok ring should only be used with a wok. No other style of pan is suitable for use with this accessory.**

If desired, the wok ring should be located on top of the pan supports. The locating cutouts on the bottom of the wok ring engage with the four fingers of the pan supports around the centre burner location.

Ensure the wok ring is located correctly, is fully engaged with the pan support fingers and is not able to rotate or slide across the pan supports before use. Always locate the wok ring before lighting the burner.

**Note:** Due to the temperatures the wok ring will operate under during use, discolouration will occur.

### **Metal Lid (Dual Fuel Models Only)**

If your Dual Fuel appliance is fitted with a Metal lid then this is **NOT** designed to cut off all hob burners when closed. Your hob burners are manufactured with flame supervision devices so in the event of this lid being closed accidentally the burners will be starved of oxygen thus cutting off the gas supply.

### **Plate rack (if supplied)**

1. Pull the shelf out of the cavity.
2. Tilt the plate warmer towards you and make sure that it hooks underneath the shelf bars at the front.
3. Drop the plate warmer carefully into position.

The plate warmer is now secure and you can place your plates into it.

Always make sure that you use oven gloves if you are putting the plate warmer into a hot, or recently used oven to prevent burns.

Always make sure that your plates are suitable for warming - some plates may shatter or crack when exposed to heat.

We recommend that you heat the oven to 70°C, or below, if you are warming plates.

### **The Griddle (if fitted)**

Only use the griddle which has been approved for use on this appliance. Do not use any other griddle, as this may be hazardous.

1. Place the griddle carefully on the pan support over the burners, using the locating feet on the underside of the griddle. Take care to avoid damage to the surface of the pan supports. The griddle should only be positioned front-to-back over the burners indicated by the griddle symbol on the fascia panel.
2. Heat the griddle on full rate for 3 minutes. The griddle plate is now ready for use.

# CLEANING YOUR APPLIANCE

## Do's

**Note:** Always switch off your appliance and allow it to cool down before you clean any part of it.

**Note:** Please take extra care when cleaning over the symbols on the control panel, as this can lead to them fading.

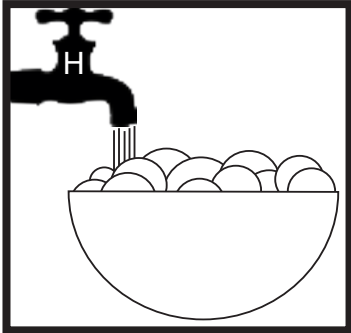

- Warm, soapy water



- Clean, wrung out cloth

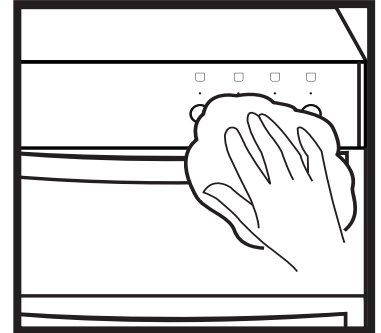

- Wipe with damp cloth
- Dry with a soft cloth

**Tips:** Some foods can mark or damage the metal or paint work e.g.; Vinegar, fruit juices and salt. Always clean food spillages as soon as possible.

## Dont's

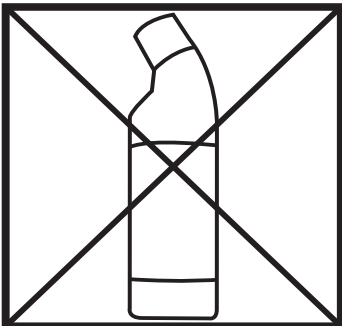

- Undiluted bleaches
- Chloride products

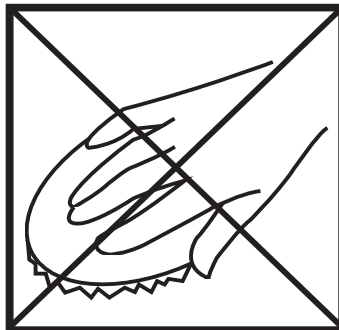

- Wire Wool
- Abrasive cleaners
- Nylon pads
- Steam cleaners

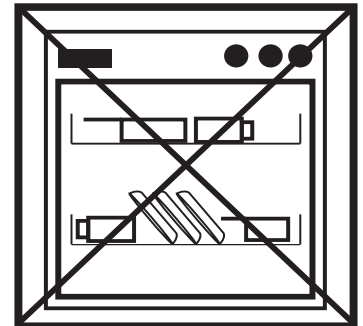

- Do not place in the dishwasher:
- Cast iron griddle
  - Pan supports

**IT IS IMPORTANT TO CLEAN YOUR APPLIANCE REGULARLY AS A BUILD UP OF FAT CAN AFFECT IT'S PERFORMANCE OR DAMAGE IT AND MAY INVALIDATE YOUR GUARANTEE.**

**IN ADDITION TO THE ABOVE, DO NOT USE METAL SCRAPERS TO CLEAN THE OVEN DOOR GLASS.**

We offer a great range of cleaning products and accessories for your appliance.  
To shop, please visit our website located at the front of this User Guide.

Please keep this handbook for future reference, or for anyone else who may use the appliance.

Please keep this handbook for future reference, or for anyone else  
who may use the appliance.

Please keep this handbook for future reference, or for anyone else  
who may use the appliance.

# TECHNICAL DATA

## Gas - range

<b>Databadge</b>	Lower part of the front frame
<b>Appliance class</b>	Class 1 - freestanding cooker
<b>Electrical supply</b>	220V - 240V ~ 50Hz
<b>Type of gas</b>	Please see data badge for your specified gas type. Can be converted from natural gas to LPG. Never attempt to convert an appliance unless the data badge states you can.
<b>Gas pressure settings</b>	G20 Natural gas @ 20 mbar G30 Butane @ 28-30mbar G31 Propane @ 37mbar
<b>Burner Aeration</b>	Fixed

**WARNING** - This cooker must be earthed

Burner / Element	Nat Gas / LPG				
	(kW)	Injector (Nat gas)	Injector (LPG)	Butane g/h	Propane g/h
Hob - small	1.00	77	50	73	72
Hob - medium	2.00	104	70	145	143
Hob - large	3.00	129	87	218	215
Hob - wok	4.00	152	100	291	286
Total heat input (5 burners)	11.50	N/A	N/A	N/A	N/A
Total heat input (7 burners)	14.50	N/A	N/A	N/A	N/A

Electrical supply / load				
Electrical supply	Oven	Appliance Size (cm) / Load kW		
		90	100	110
240v	Conventional	N/A	2.07	2.07
	Fanned	2.00	2.00	2.00
	Multi-function	2.09	N/A	N/A
	Fanned (90cm tall oven)	2.50	N/A	N/A
	Dual variable grill (if fitted)	1.7 / 2.7	1.7 / 2.7	1.7 / 2.7
	Single variable grill (if fitted)	1.85	1.85	1.85
	Conventional top (if fitted)	1.39	1.39	1.39

Oven Lamps / Fans	
Lamps	25W each
Cooling fans	10W each
Oven stir fans	30W each

Electrical supply / load			
	Appliance Size (cm)	Electrical supply	Max. load (kW)
Single grill models	90	240v	6.48
	100/110		6.02
Dual grill models	90		7.33
	10/110		6.87
Multi-function models	90		7.42