

GYRO REMOTE CONTROL SERIES 2.4G

X22W

**4-CHANNEL REAL-TIME-TRANSMISSION POSITION HOVERING
REMOTE CONTROL DRONE**

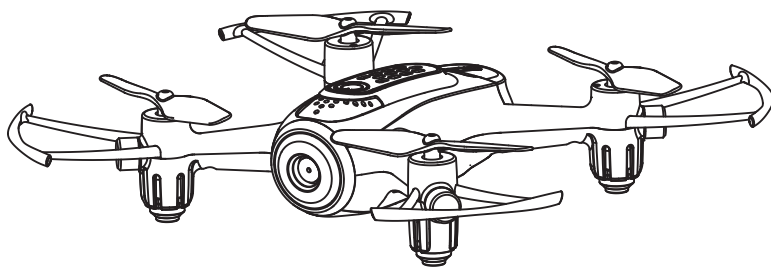

1 USER MANUAL

MAIN FEATURES

- Utilizes the 4-axis structure, enabling the drone to be even more flexible, speedy. It can fly indoor .
- Built-in 6-axis gyro stabilizer to ensure accurate positioning in-flight.
- The structure uses a modular design which makes it easy to install and repair.
- Headless function making it easy for directional control.
- Pressure-fixed-position hovering function for Auto Hover Mode.
- 360° stunt flip.
- Auto take-off and landing.
- HD wireless real-time transmission aerial for getting the fun of different photography.

Safety Guide

1. Please store the smaller-sized drone accessories in places that are out of reach of children.
2. This drone is very powerful. For all first-time flights, the left joystick must be slowly pushed up in order to prevent the drone from ascending too fast to avoid unnecessary collision and possible damage and injury.
3. When the flight is ended, first turn off the power of the remote control. Then turn off the power of the drone.
4. Avoid placing the batteries in places with high temperatures and exposure to heat.
5. It is strongly recommended to operate the drone at 2-3 meters away from a pilot and other people or animals. Crashes may cause unintended injuries. When landing the drone, avoid crashing it into other people.
6. This drone is for people ages 8+. It must be flown always within the line of sight of the pilot (or instructor) and flown safely.
7. Non-rechargeable batteries are not to be recharged; Batteries are to be inserted with the correct polarity; Different types of batteries or new and used batteries are not be mixed.
8. When the drone is not in use, please remove the batteries in the remote control.
9. The supply terminals are not be short-circuited.
10. Discharge the battery to 40%-50% (On a full charge, fly for half of the total flight time) if it will not be used for 10 days or more, this can greatly extend the battery life.
11. Please keep a safe distance from the spinning propellers to avoid injury.
12. To ensure the electromagnetic environment requirement of the aviation radio (station), using remote controls in the zone, which is in a radius of about 5000m zone from the circle center of the airport runway, is forbidden. All users also should abide by the regulation of the radio set forth by government and regulatory agencies including the duration and area.
13. Only uses the recommended transformer for the model, and the transformer is not a model. Disconnect the transformer from the model which is available cleaning with liquids before cleaning. Check the cord, plug, enclosure and other parts of the transformer regularly. If any damages have been discovered, please immediately stop using it, until it was completely repaired.
14. Never look steadily at the laser beam since the laser radiation.
15. Attention: Drone assembly under adult supervision.
16. The pilot is responsible for the safe operation and safe distance from uninvolved persons and property on the ground and from other airspace users and shall never fly the drone above crowds (> 12 persons).
17. The packing has to be kept since it contains important information.

Repair and Maintenance

1. Use dry and soft cloth to clean this product.
2. Avoid exposing this product to heat.
3. Do not immerse this product in water, otherwise, the electronic parts will be damaged.

4.Transformers used with the toy are to be regularly examined for damage to the cord,plug,enclosure and other parts,and that,in the event of such damage,the toys must be used with this transformer until the damage has been repaired.

Package Description

The following items can be found in this product package:

- Drone
- Remote Control
- Instruction Manual
- Recharge stand
- Main Blades
- USB Cable
- Mobile Phone Retaining Clip



Blade Replacement Method

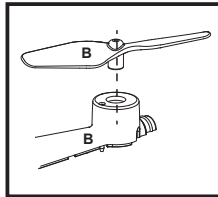
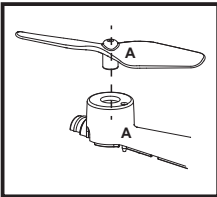

- 1.Pull out the blades that need to be replaced.
- 2.As shown on left, the blade A is mounted to the arm "A" position, and the blade B is mounted to the arm "B" position.

Phone Clip Attachment/Removal Method

Phone clip holder installation:

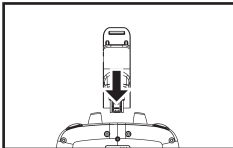

- 1.Insert the phone clip holder into the connector at the top of the remote control.

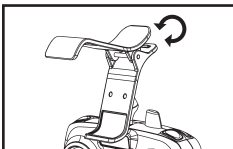

- 2.Press the spring clip to adjust for size.

Phone clip holder dismantle:

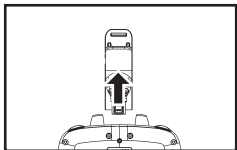

- 1.Pull up the phone clip holder from behind the remote control.

Fuselage Battery Charging Instruction:

- 1.Connect recharge stand and computer USB port by USB charging cable.

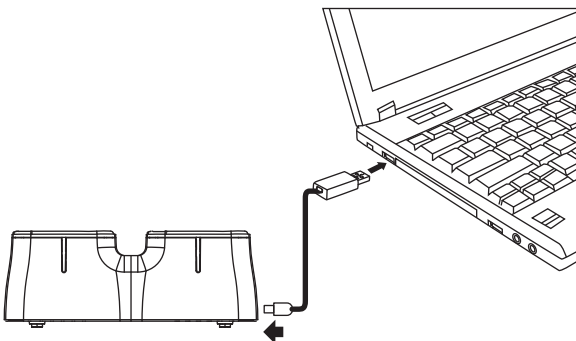

- 2.When the recharge stand connect to computer,the recharge stand indicator light is off,then plug the battery into the recharge stand,and the indicator light will be on,the indicator light will be off again when the battery is fully charged.

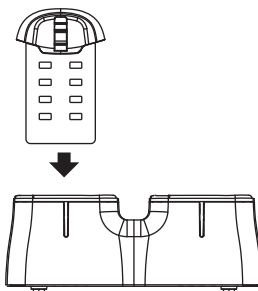

The charging time is about 90 minutes; Hover flight time is approximately 5 minutes.

Precautions as follows during charging of battery:

- Avoid placing the active batteries in places with direct exposure, sunlight and high temperatures. For example, naked light or electrical equipment installations; otherwise it may cause damages or explosions .
- Avoid immersing the batteries in the water. The batteries shall be

- stored in a cool and dry place.
- Avoid dismantling the batteries.
- During the charging of battery, avoid leaving the charging place.
- Rechargeable batteries are to be removed from the toy before being charged;
- Rechargeable batteries are only to be charged under adult supervision;
- Exhausted batteries are to be removed from the toy;
- Caution: Risk of explosion if battery replaced by an incorrect type, dispose of used batteries according to the instructions.

Understanding Your Remote Control

Remote control's button function description:

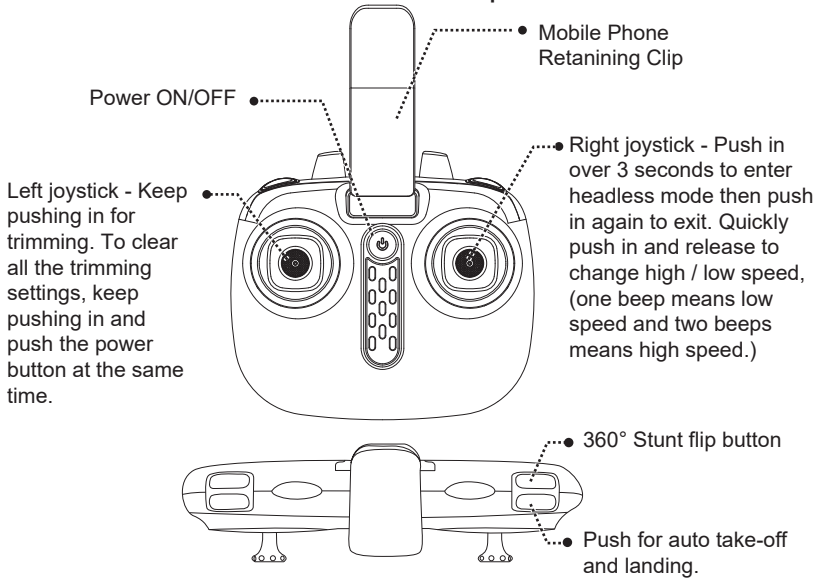

Battery installation for remote control:

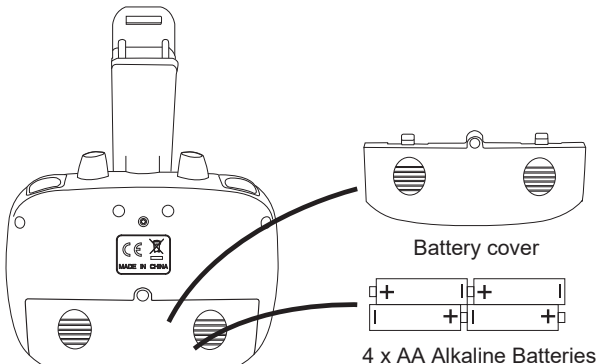

1. Battery Installation Method: Open up the battery cover at the back of the remote control. Correctly place 4 x AA alkaline batteries in the battery box in strict adherence to the polarity instructions (the AA alkaline batteries are not included).



1. During the battery installation, it must be ensured that the polarities of the batteries are matched with that of the battery box. No battery shall be installed with the opposite polarity.
2. Do not use new and old batteries together.
3. Different types of batteries are not be mixed.
4. Do not use rechargeable batteries.

Product Features

1. Low-voltage Protection:

When the two indicator lights at the rear of the drone start flashing, it means that the drone's battery power is low. At this time, please control the drone return. The drone will automatically slow down when it is short of power.

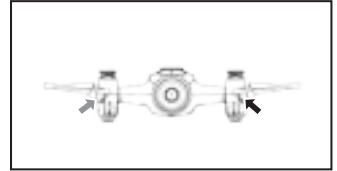

2. Over-current Protection:

If the drone encounters a direct impact from a foreign object, or is obstructed, or if the blades are not rotating, the drone will go into over-current protection mode.

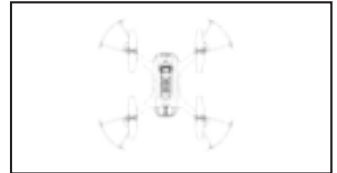

3. Level Calibration Function:

Place the drone on a level surface and at the same time, push both left and right joysticks to the lower right corners for 2 to 3 seconds; the led light indicator on the drone will blink rapidly, and it will return back to the normal status after about 2 to 3 seconds. The level calibration is successful.

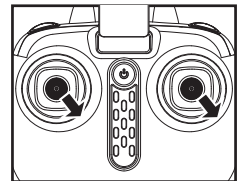

4. Fast/Slow Speed Function:

Slow speed by default when first powered-on. Possible to switch the function mode of fast/slow speed by pressing in on the right joystick for a short time. It is switched into fast speed mode when two “beep” sounds come from the remote control, pressing in on the right joystick for a short time under fast speed mode and then one “beep” sound would come from the remote control, then it is then switched back into slow speed mode.

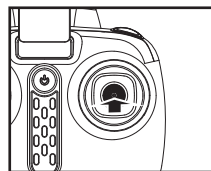

5. 360° Stunt Flip Function:

When you are familiar with the basic actions, you can proceed to explore even more exciting stunt actions. Fly the drone to a height of 3M above the ground, push the upper right corner button (Stunt Flip Button) on the remote control and simultaneously push the right joystick to the farthest position of Front/Back/Left/Right, the drone will now execute the Front/Back/Left/Right stunt flip action.

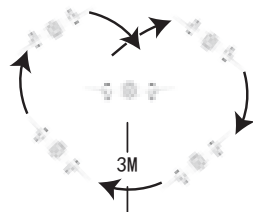

Note: Drone will have the best stunt flip action when the batteries are fully charged.

6. Auto Hover Function:

After using the left joystick (throttle) to control the ascending / descending flight of the drone, release the left joystick (accelerator) and the drone will hover at that height when the joystick is released.

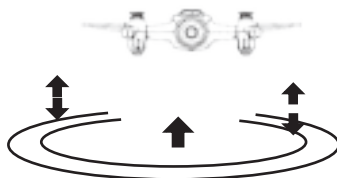

7. Headless Function:

1. Defining forward direction:

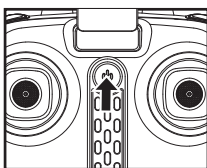

1. Push on the power button of the remote control.

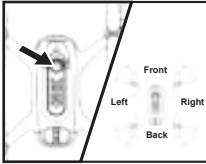

2. Press the power button on the top of the drone to 1-2s make sure the drone is turned "ON", and adjust the specified direction of the drone's head under the headless mode as the new forward direc.

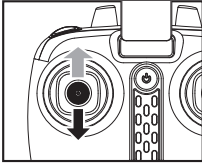

3. Push the left joystick (throttle) on the remote control up to the farthest position and then pull down to the farthest position. When the remote control issues a long beep sound, it means the frequency and defining forward direction functions are completed.

2. Calibration for the definition of the front:

1. When the drone encounters a direct impact with foreign objects in the headless mode, if there is an occurrence of deviation of the defined direction, it is only required to push both the left and right joysticks to the bottom left corners simultaneously after placing the flying direction of the drone in the correction position. When the led light indicator of the drone is in a long "ON" mode after slowly flashing for 3 seconds, it indicates the calibration is complete.

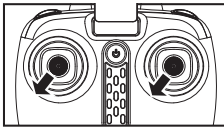

3. Toggling between headless function and normal function:

1. After the drone is matched with the corresponding frequency, the drone would be in normal pattern by default. At this time the indicator light on the drone would be in a state of on for a long time. After pressing in on the right joystick of the remote control for 2 seconds, the remote control would make a sound of "beep, beep, beep" to show that it has entered into a state of headless mode. Pressing in on right joystick for 2 seconds then a long sound of "beep" would be heard to show an exit status. (When under the state of headless mode, four indicator lights on the drone are led lights which flicker once every four seconds)

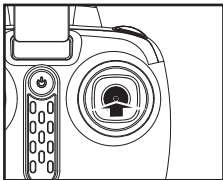

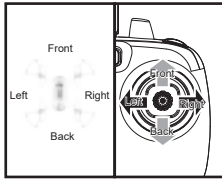

2. Under the headless mode, the operator does not need to differentiate the head position of the drone, and only needs to control the drone's direction front/back/left/right by using the right joystick direction on the remote control.

8. Wireless Real-Time Transmission Function

1. Downloading the installation software

For Android phones, download and install the SYMA GO APP by visiting the www.symatoys.com or by scanning the QR code.

For IOS Apple phones, download and install the SYMA GO APP by visiting the App Store or by scanning the QR code.

Reminder: QR codes are provided on the packaging box and at the bottom of the user manual. Please visit website www.symatoys.com or the App Store/Google Play to obtain the newest SYMA GO App.

2. How to connect

1. Turn on the drone, about 10 seconds later, the WiFi indicator under the drone will flash slowly, and waiting to connect with phone.
2. At this time, enter the "Settings" option on your phone, and turn on WLAN. In the WLAN search list, look for a network called "FPV-WIFI-****" and connect to it. Once connection has been established, exit the "Settings" option.
3. Open the SYMA GO App, click the "START" icon to enter the control interface. A full bar in the signal strength icon indicates the strongest possible signal.



1. Open up SYMA GO APP.



2. Click the "START" icon, the system will enter the APP operation interface automatically.



3. The phone's screen will display real-time images.

3. Interface icon instructions

Mobile APP control interface

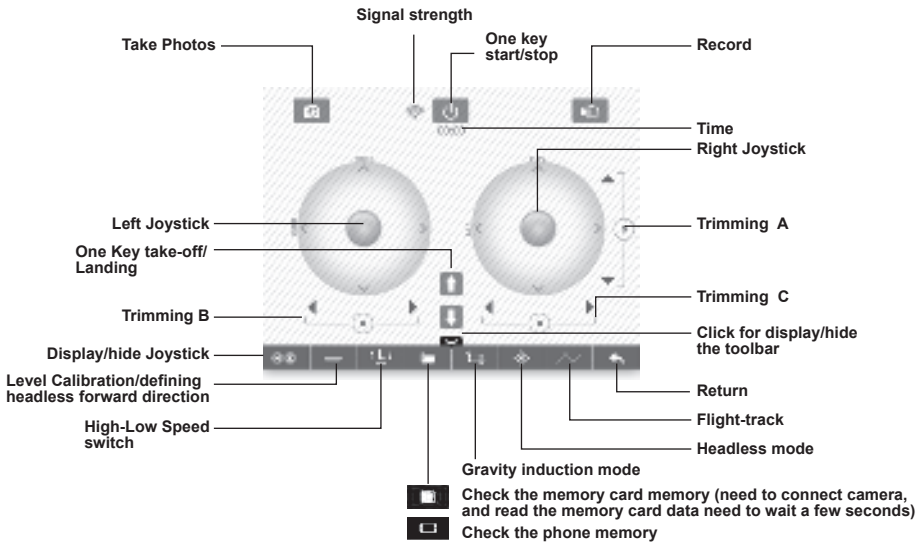

Flight-track operation interface

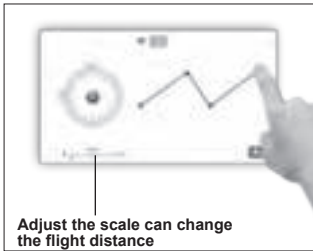

Press the flight-track button to enter into the flight-track interface, and the drone will flight in accordance with recorded route.

4. Real-time aerial photography uploading:

Photo/Record: When the camera is operating normally, press the photo/record icon in the real-time upload interface to take photos/videos. (Photos/recordings that were taken can be viewed in the “View Photo and Video” folder)

Note: When using the real-time upload operation in the app, the range for the operating distance of the aircraft will reduce by half. The wireless real-time upload function is optimal in spacious environments.

5.Camera storage function:

1.When take pictures or record videos by mobile phone, the photos/videos will be stored in the folder on the APP control interface of the mobile phone.

Flight Preparation and Switching the Drone On and Off

1. Flight preparation

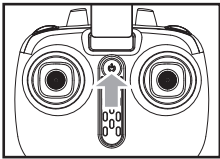

Step 1: Push the power button of the remote control.



Step 2: Press the power button on the top of the drone to 1-2S make sure the drone is turned "ON".

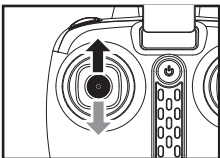

Step 3: Push the left joystick (accelerator) up to the highest point and then push down to the lowest point. When the led indicator lights in the drone change from quick flashing to continuous light, it means that the drone goes into the flight standby mode.

2. Turning on the drone

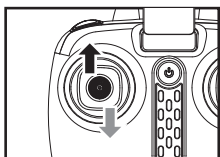

Method 1: push the left joystick (accelerator) to the highest point and then back to the center, the blades of the drone start rotating slowly.

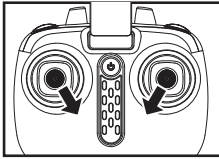

Method 2: Move the left and right joysticks inwards in an internal loop of “8” for 1 second, the blades of the drone start rotating slowly.

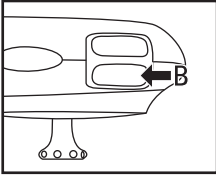

Method 3: When the drone is stationary, press the B button, the drone automatically takes off and hovers at a certain height.

3. Turning off the drone

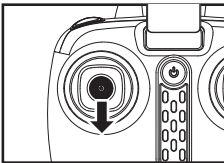

Method 1: Push the left joystick (Accelerator) to the lowest level and hold there for 2 to 3 seconds, the drone can then be turned off.

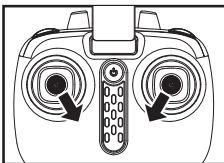

Method 2: Move the left and right joysticks inwards in an internal loop of “8” for 1 second, and the drone can be turned off.

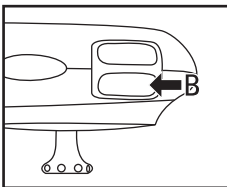

Method 3: When the drone is in flight, press the B button, the drone will descend to the ground and lands.

1.If the drone is out of the range of the flight, the indicator light will flash slowly, and then slow down.

2.When the remote control is switched off or the power is cut off, the drone will automatically slow down to stop.In the process , open the remote control to control again.

Drone Controlling Diagram

Operating direction

Ascending and descending control

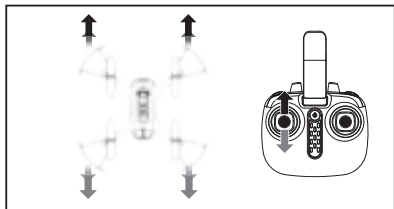

When the left joystick (Accelerator) is pushed upwards or downwards, the drone will ascend or descend correspondingly.

Forward and backward control

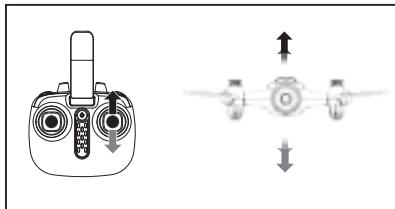

When the right joystick (Direction Rudder) is pushed upwards or downwards, the drone will advance forward or backward correspondingly.

Left turning and right turning control

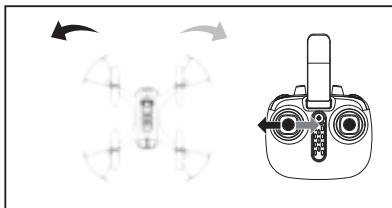

When the left joystick (Accelerator) is pushed towards the left or right, the drone will turn left or right correspondingly.

Left side flying and right side flying control

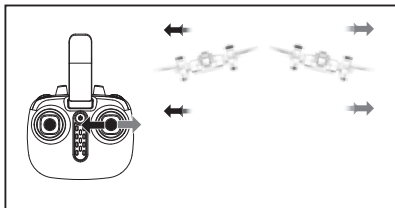

When the right joystick (Direction Rudder) is pushed towards the left or right, the drone will fly sideways to the left or right correspondingly.

Trimming operation

Forward and backward trim control

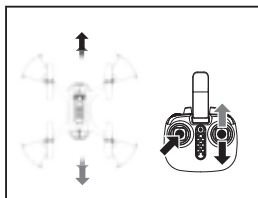

While the drone is hovering in the air, it automatically flies forward/backwards, press in on the left joystick and at the same time push the right joystick forward/backward slightly to fine tune the direction. Don't release the left joystick until the drone is flying in a stable state.

Left/right side flight trim control

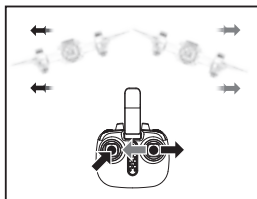

While the drone is hovering in the air and automatically flies left/right, press in on the left joystick and at the same time push the right joystick left/right slightly to fine tune the direction. Don't release the left joystick until the drone is flying in a stable state.

Left/right side turning trim control

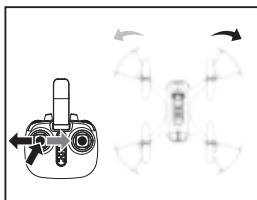

While the drone is hovering in the air, when the drone automatically rotates and flies towards the left/right, press in on the left joystick and at the same time move joystick to the right or left to adjust the direction. Don't release the left joystick until the drone is flying in a stable state.

Warning: Changes or modifications to this unit not expressly approved by the party responsible for compliance could void the user's authority to operate the equipment.

NOTE: This equipment has been tested and found to comply with the limits for a Class B digital device, pursuant to Part 15 of the FCC Rules. These limits are designed to provide reasonable protection against harmful interference in a residential installation. This equipment generates, uses and can radiate radio frequency energy and, if not installed and used in accordance with the instructions, may cause harmful interference to radio communications.

However, there is no guarantee that interference will not occur in a particular installation. If this equipment does cause harmful interference to radio or television reception, which can be determined by turning the equipment off and on, the user is encouraged to try to correct the interference by one or more of the following measures:

- Reorient or relocate the receiving antenna.
- Increase the separation between the equipment and receiver.
- Connect the equipment into an outlet on a circuit different from that to which the receiver is connected.
- Consult the dealer or an experienced radio/TV technician for help.

“This device complies with FCC radiation exposure limits set forth for general population (uncontrolled exposure).
This device must not be collocated or operating in conjunction with any other antenna or transmitter.”

Declaration of Conformity Inserts:

“Hereby, GuangDong Syma model aircraft Industrial co.,ltd, declares that this drone is in compliance with the essential requirements and other relevant provisions of Directive 2014/53/EU.”

A copy of the full DoC is attached.

Accessories/Parts List (Optional)



Main component
(White)



Main component
(Black)



Rotor Blade



Protective frame



Lamp Cover



Silicone rubber
Ring



Battery Fixer
(White)



Battery Fixer
(Black)



Lipo battery
(White)

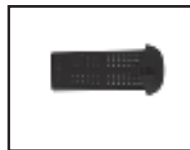

Lipo battery
(Black)



X22W Camera

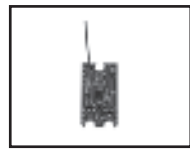

X22W Receiver
Board

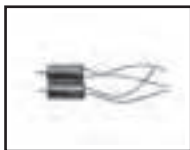

MotorA

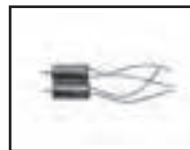

MotorB



light Board



Recharge stand



Remote Control



Mobile Phone
Retaining Clip

Product Descriptions

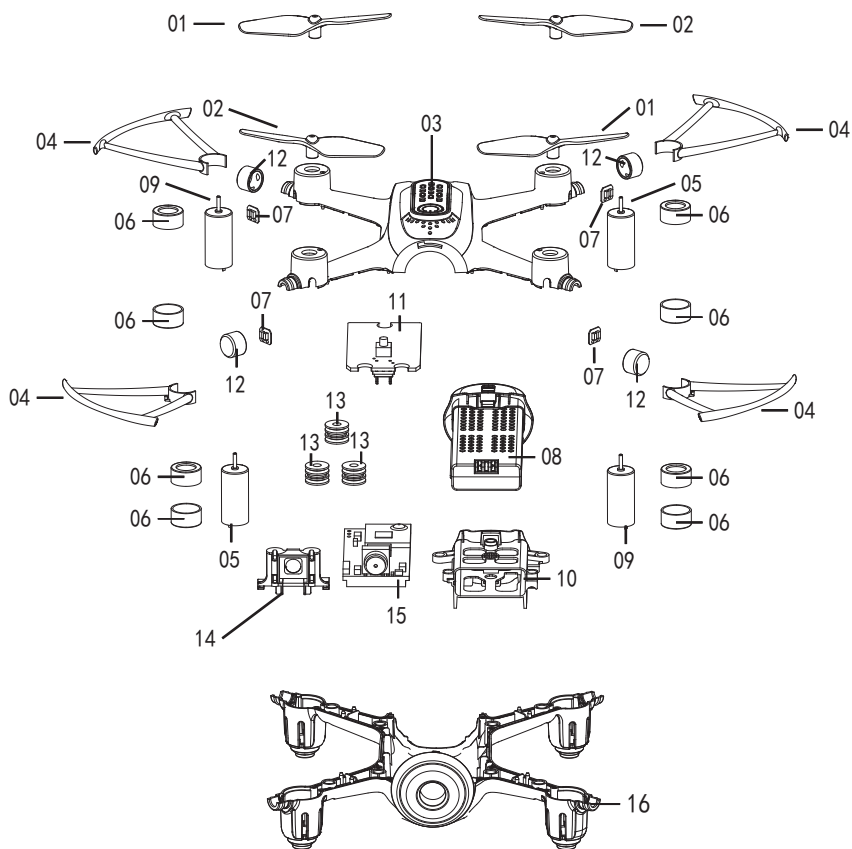

Serial number	Component/Part Name	Quantity	Serial number	Component/Part Name	Quantity
01	Clockwise Blades	2	10	Battery Storehouse	1
02	Counter-Clockwise Blades	2	11	Receiver	1
03	Top Main Body	1	12	Light Protective Cover	4
04	Protective Guard	4	13	Shock Absorber Ring	3
05	Counter-Clockwise Motors	2	14	Camera Mount	1
06	φ8 Silicon Rubber Ring	8	15	Camera Board Component	1
07	Light Board	4	16	Bottom Main Body	1
08	Battery Elements	1			
09	Clockwise Motors	2			

Main Specifications

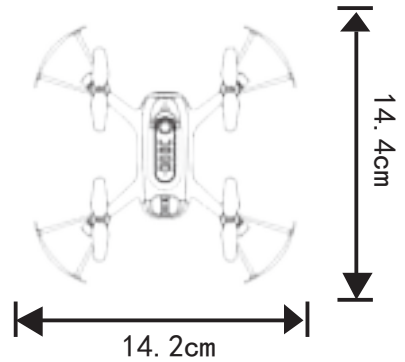
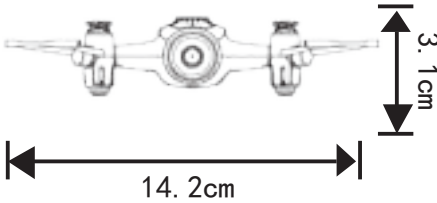

Drone's Length : 14.4cm

Drone's Width : 14.2cm

Drone's Height : 3.1cm

Motor's Model : ϕ 8

Battery : 3.7V 400 mAh lithium battery

Rectification Procedures

Problem	Reason	Solution
The drone has no response	<ol style="list-style-type: none"> 1. The drone has entered into lowvoltage protection. 2. When the power of the remote control is weak, the power light indicator will blink. 	<ol style="list-style-type: none"> 1. Charge up the drone. 2. Change the batteries of the remote control.
The flight response of the drone is not sensitive	<ol style="list-style-type: none"> 1. The power of the remote control is weak. 2. There is an interference with the same frequency as that of the remote control. 	<ol style="list-style-type: none"> 1. Change the batteries. 2. Change to a place where there is no interference with the same frequency.
The drone is flying towards its side in one direction during hovering	<ol style="list-style-type: none"> 1. The drone is not calibrated level to the ground. 	<ol style="list-style-type: none"> 1. Re-adjust the calibration until the drone is level to the ground. For further details, see No.3 on Page 5 for details (Function of horizontal adjustment).
In the headless state, it is biased towards the front direction	<ol style="list-style-type: none"> 1. Many collisions may cause head biasness. 	<ol style="list-style-type: none"> 1. Re-define the front direction. For further details, see on Page 6 for details (Headless Function).
Fixed high instability / up and down movement	<ol style="list-style-type: none"> 1. The drone is not calibrated level to the ground. 2. Unstable air pressure under the severe weather condition. 3. Violent collision resulting in data disorder of gyroscope. 	<ol style="list-style-type: none"> 1. Re-adjust the calibration until the drone is level to the ground. For further details, see No.3 on Page 5 for details (Function of horizontal adjustment). 2. Avoid to fly under the severe weather condition. 3. Make horizontal adjustment again, see No.3 on Page 5 for details (Function of horizontal adjustment).



**QR code for android
system**



**QR code for apple
iOS system**

Manufacturer

Guangdong Syma Model Aircraft Industrial Co., Ltd.

The Crossing of No.2 West Xingye Road and North Xingye Road,Laimei.

Industrial Park Chenghai District Shantou City Guangdong China.

Contact person: SYMA Telephone: +86 0754 86381898

The company has the right of final interpretation
of this instruction manual statement.