

# PHILIPS

DSK602  
9290031795

Mounting Instructions

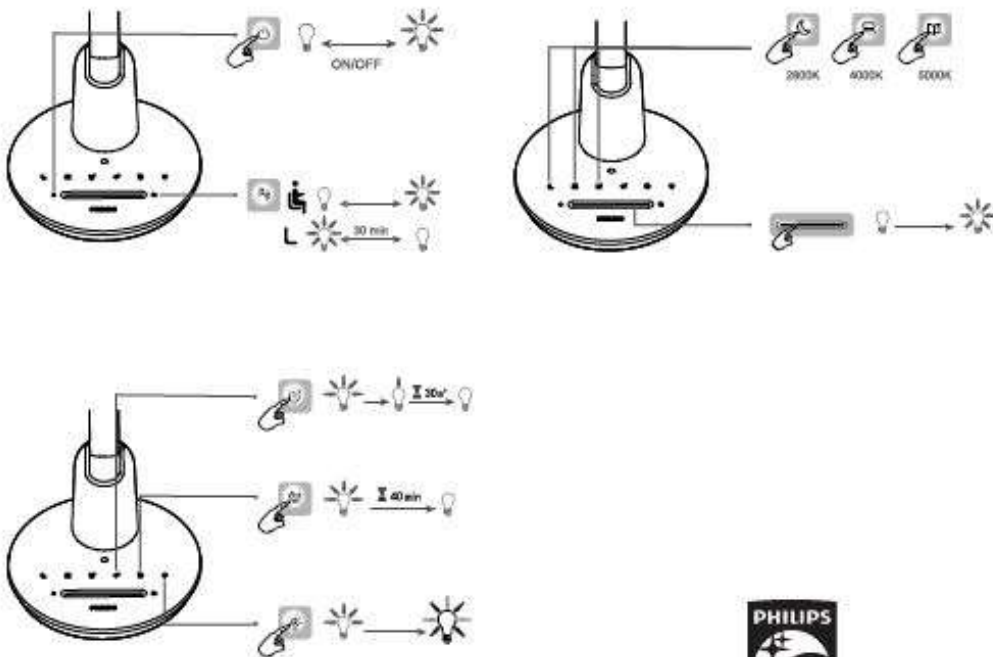
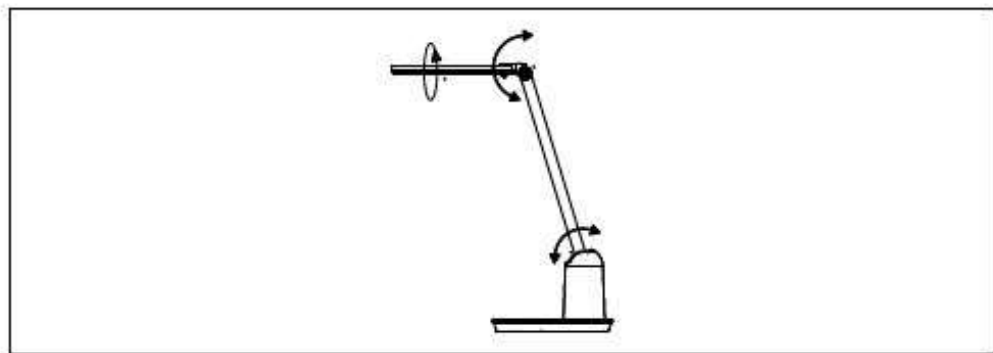
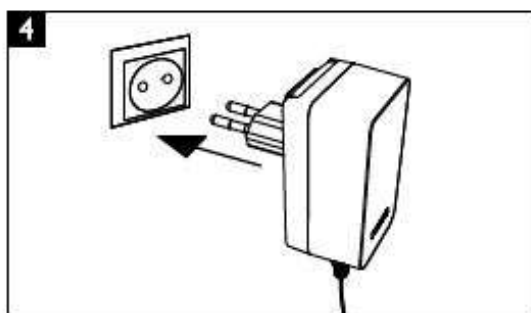
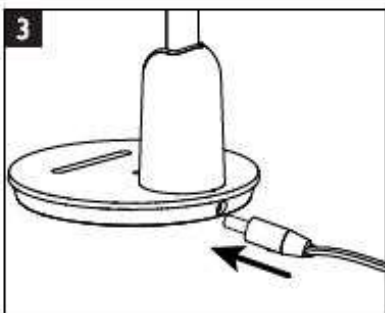
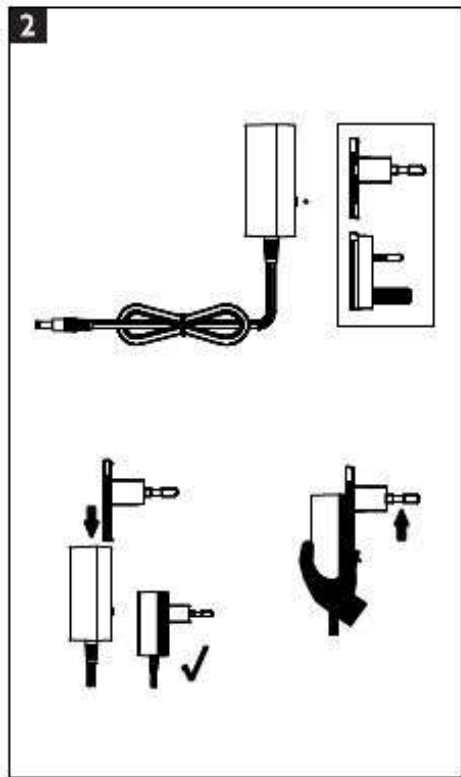
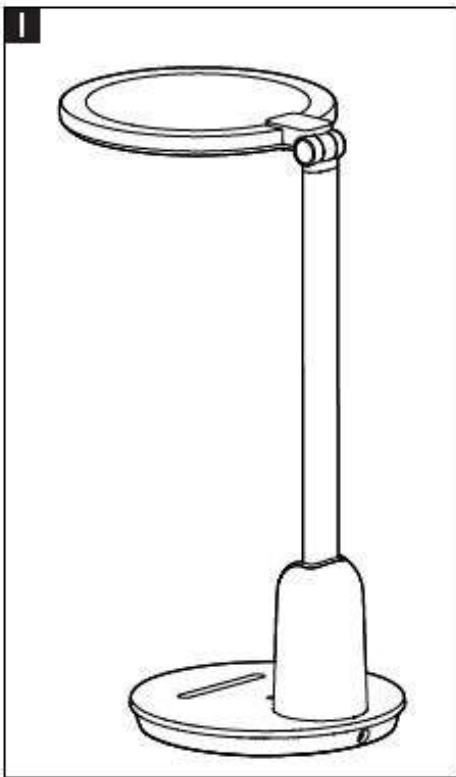
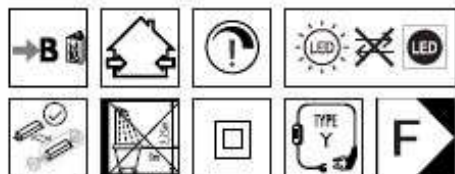

Philips and the Philips shield emblem are registered trademarks of Koninklijke Philips N.V.

SIGNIFY (CHINA) INVESTMENT CO., LTD.  
BUILDING NO. 9, LANE 888, TIANLIN ROAD,  
MINHANG DISTRICT, SHANGHAI, CHINA  
POSTAL CODE: 200233

SIGNIFY COMMERCIAL UK LIMITED  
UNIT 3, GUILDFORD BUSINESS PARK,  
GUILDFORD, SURREY, GU2 8XG, UK  
3241 658 23072

© 2021 Signify Holding  
©ignify