

PHILIPS

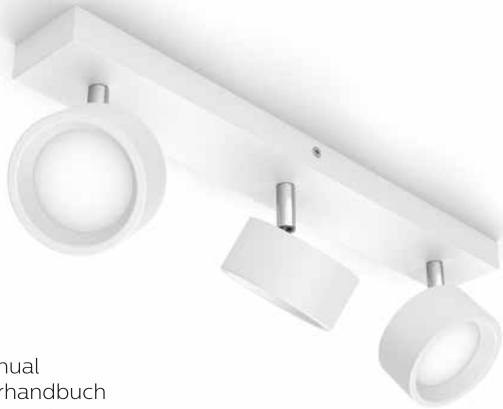

Bracia
9290032988
9290032992



User manual
Benutzerhandbuch
Notice d'emploi
Manual de usuario
Manual do usuário
Manuale d'uso
Gebruiksaanwijzing

Incl.

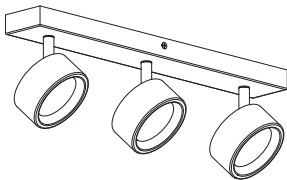

Excl.

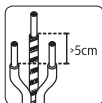
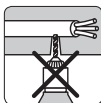
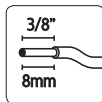
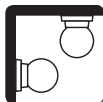
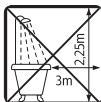
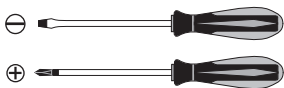
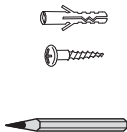
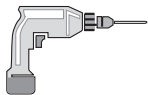

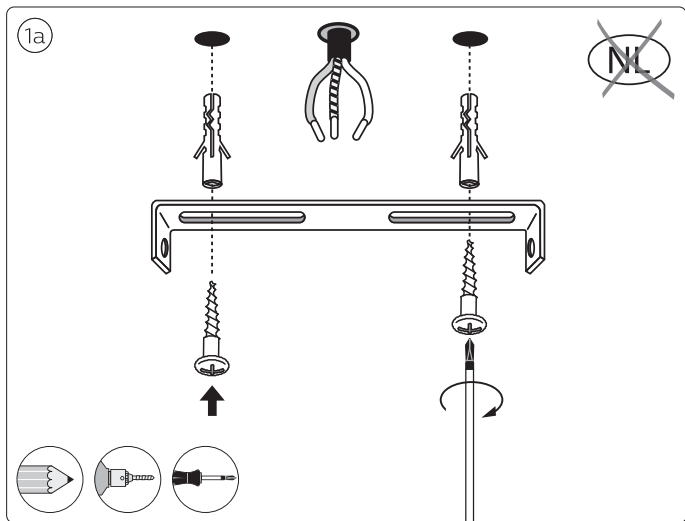
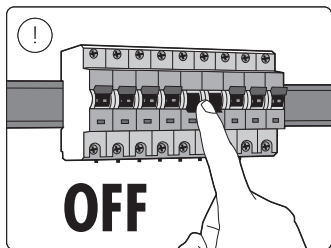

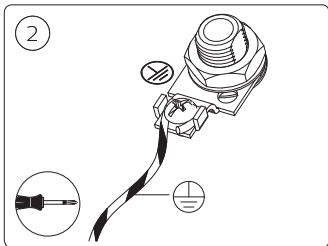
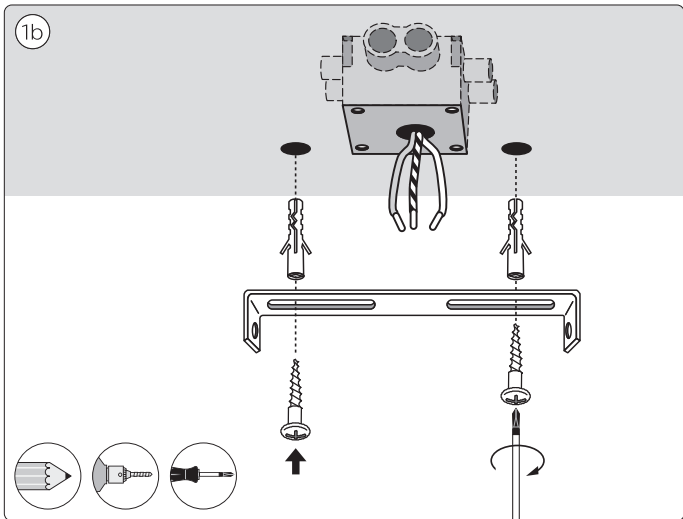

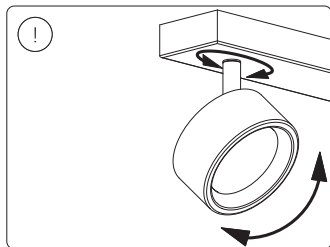
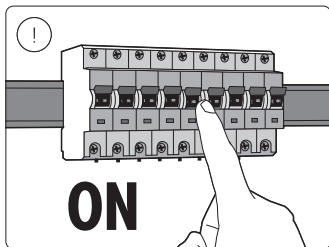
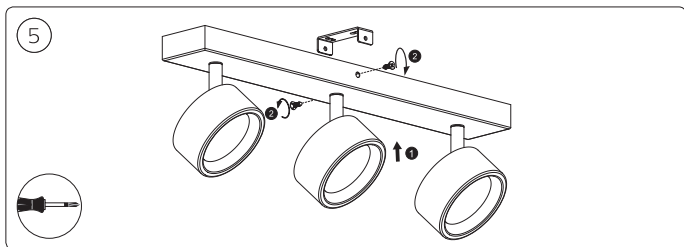
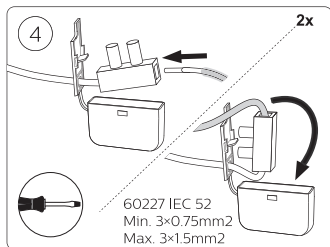
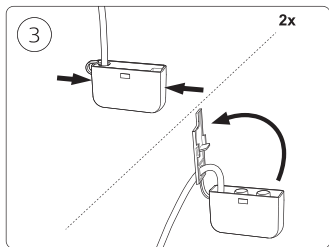



Signify Commercial UK Limited
Unit 3, Guildford Business Park, Guildford,
Surrey, GU2 8XG, UK

Signify
I.B.R.S. / C.C.R.I. Numéro 10461
5600 VB Eindhoven,
the Netherlands
☎00800-74454775

© 2022 Signify Holding

 **signify**

Philips and the Philips Shield Emblem
are registered trademarks of Koninklijke
Philips N.V. and are used under license

www.philips.com/lighting

3241 660 32711