

# PHILIPS

Bracia  
9290032986  
9290032990



User manual  
Benutzerhandbuch  
Notice d'emploi  
Manual de usuario  
Manual do usuário  
Manuale d'uso  
Gebruiksaanwijzing

Incl.

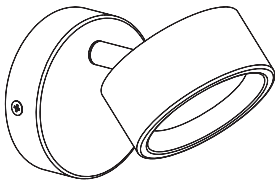

Excl.

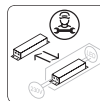
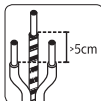
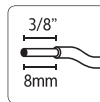
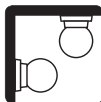
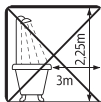
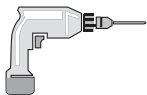

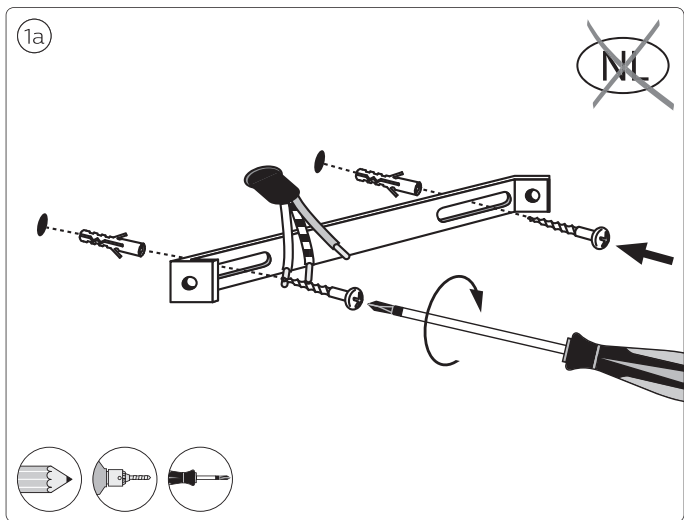
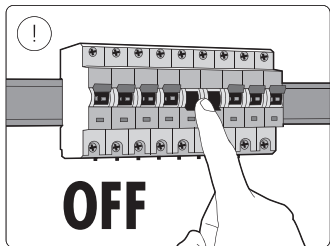

1b

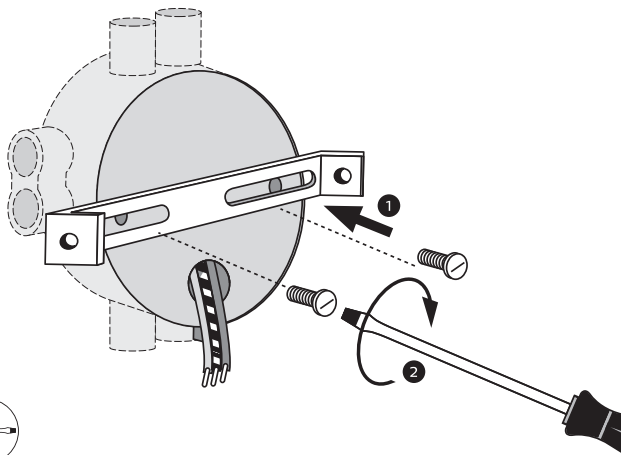

2

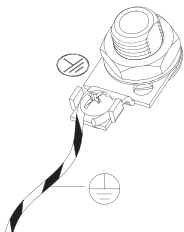

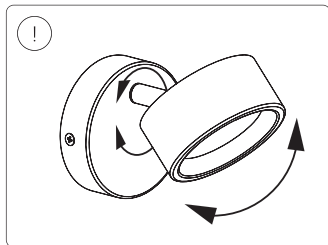
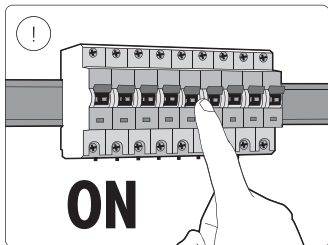
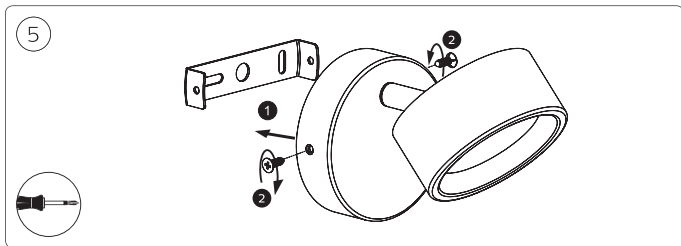
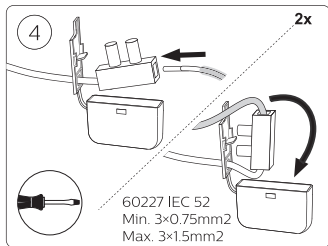
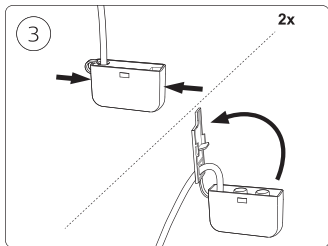



Signify Commercial UK Limited  
Unit 3, Guildford Business Park, Guildford,  
Surrey, GU2 8XG, UK

Signify  
I.B.R.S. / C.C.R.I. Numéro 10461  
5600 VB Eindhoven,  
the Netherlands  
☎00800-74454775

© 2022 Signify Holding

 **signify**

Philips and the Philips Shield Emblem  
are registered trademarks of Koninklijke  
Philips N.V. and are used under license

[www.philips.com/lighting](http://www.philips.com/lighting)

3241 660 32691