

playmobil®



Heidi

70253

Heidi

Heidi liebt ihr Leben hoch oben in den Bergen – mit ihrem Großvater Alm-Öhi, dem Bernhardiner Josef und ihrem Freund Peter, mit dem sie zusammen die Ziegen des Dorfes hütet und dabei viele Abenteuer erlebt. Dieses sorgenfreie Leben ist vorbei, als Heidis Tante Dete auf der Alm erscheint und sie mit nach Frankfurt nimmt, wo Heidi dem gehbehinderten Mädchen Clara Gesellschaft leisten soll. Die beiden Mädchen freunden sich sofort an und träumen davon, gemeinsam in die Berge zurückzukehren.

Heidi loves living high up in the mountains with her Grandfather, Alm-Ohi, her dog, Josef, and her friend Peter, with whom she tends the village goats and experiences a lot of adventures. This care-free life ends when Heidi's Aunt Dete comes to the mountain pasture and takes Heidi with her to Frankfurt to keep a physically disabled girl called Clara company. The two girls get on well right away and dream of returning to the mountains together.

Heidi adore sa vie pleine d'aventures là-haut dans les montagnes – avec son grand-père Alm-Öhi, le Saint-Bernard Josef et son ami Peter, avec qui elle garde les chèvres du village. Cette vie d'insouciance prend fin lorsque la tante de Heidi, Dete, arrive dans les alpages et l'emmène à Francfort, où Heidi doit rejoindre la petite handicapée Clara, pour lui tenir compagnie. Les deux jeunes filles s'entendent immédiatement et rêvent de retourner ensemble dans les montagnes.

Heidi adora la vida en las montañas junto a su Abuelito, su perro Niebla y su amigo Pedro, con el que pastorea las cabras del pueblo y con el que vive numerosas aventuras. Esta vida tranquila se trunca cuando su tía Dete aparece para llevar a Heidi hasta Frankfurt, donde deberá hacer compañía a Clara, una niña que no puede caminar y utiliza silla de ruedas. Entre las dos niñas nace una gran amistad de inmediato y ambas sueñan con poder regresar juntas a las montañas.

Heidi

Heidi ist ein richtiges Kind der Berge. Sie liebt die Natur und die Tiere. Am liebsten ist sie barfuß mit ihrem besten Freund Peter in den Bergen unterwegs, trinkt frische Ziegenmilch und entdeckt die faszinierende Welt der Alpen.

Heidi is a true child of the mountains. She loves animals and nature. Her favourite things to do are walk barefoot in the mountains with her best friend Peter, drink fresh goat milk and explore the fascinating world of the Alps.

Heidi est une véritable enfant des montagnes. Elle adore la nature et les animaux. Elle adore marcher pieds nus dans les montagnes avec son meilleur ami Peter, boire du lait de chèvre frais et découvrir le paysage fascinant des Alpes.

Heidi es una auténtica niña de montaña a la que le encanta la naturaleza y los animales. Lo que más le gusta es andar descalza de un lado para otro con su mejor amigo Pedro, beber leche fresca de cabra y descubrir el fascinante mundo de los Alpes.



Peter



Peter ist Heidi's bester Freund und er weiß sehr viel über das Leben in den Bergen. Am besten kennt er sich als Ziegenhirte natürlich mit Ziegen aus. Heidi geht fast jeden Tag mit ihm auf die Alm und die beiden erleben spannende Abenteuer.



Peter is Heidi's best friend and knows a lot about life in the mountains. As a goatherd he is obviously an expert when it comes to goats. Heidi joins him on the pasture almost every day and the two experience exciting adventures together.



Peter est le meilleur ami de Heidi et les montagnes n'ont pas de secret pour lui. En tant que berger des montagnes, il connaît très bien les chèvres. Heidi l'accompagne presque tous les jours dans les alpages où ils vivent tous les deux des aventures passionnantes.



Pedro es el mejor amigo de Heidi y sabe muchísimo sobre la vida en las montañas. Es cabrero y, por tanto, de lo que más sabe es de cabras. Heidi lo acompaña casi cada día hasta la pradera y juntos viven emocionantes aventuras.



Clara



Die Halbwaise Clara sitzt im Rollstuhl. Da ihr Vater oft auf Geschäftsreisen ist, übernimmt das strenge Fräulein Rottenmeier die Erziehung. Als sich Heidi und Clara das erste Mal in Frankfurt begegnen, wusste Heidi sofort, dass sie beste Freundinnen werden würden.



Clara has lost her mother and is in a wheelchair. Because her father is often away on business, she is raised by the strict housekeeper Fräulein Rottenmeier. When Heidi and Clara meet for the first time in Frankfurt, Heidi knows right away that they will be best friends.



Clara a perdu sa mère et doit rester en fauteuil roulant. Son père étant souvent en voyage d'affaires, c'est Mademoiselle Rottenmeier qui, d'une main de fer, prend en charge son éducation. Lorsque Heidi et Clara se sont rencontrées pour la première fois à Francfort, Heidi a su immédiatement qu'elles allaient devenir les meilleures amies du monde.



Clara es una niña huérfana de madre que va en silla de ruedas. Como su padre viaja mucho por negocios, la exigente Señorita Rottenmeier se encarga de su educación. Cuando las dos niñas se vieron por primera vez en Frankfurt, Heidi supo de inmediato que se harían muy buenas amigas.



Alm-Öhi



Heidis Großvater ist manchmal ein ganz schöner Grummelbär. Die Leute aus Dörfli nennen ihn Alm-Öhi. Am Anfang wollte Großvater die Heidi nicht bei sich haben, aber schon bald hat er sie in sein Herz geschlossen. So lebt Heidi bei ihm auf der Almhütte.

Heidi's Grandfather can be really grumpy at times. The people of Dörfli call him Alm-Ohi. Initially, Heidi's Grandfather wasn't happy that she was living with him, but he soon grew fond of her. Heidi lives with him in his mountain hut.

Le grand-père de Heidi est parfois un vrai ours grincheux. Les habitants de Dörfli l'appellent Alm-Öhi. Même si au début grand-père ne voulait pas avoir Heidi auprès de lui, il s'est très vite pris d'affection pour elle. Heidi vit donc avec lui à la bergerie.

El abuelo de Heidi es a veces un auténtico gruñón. En Dörfli, la gente lo conoce como «Abuelo». Al principio, el abuelo no quería que Heidi se quedase con él, pero la niña se hizo pronto un hueco en su corazón. Heidi se quedó a vivir con él en la cabaña.

Josef

Großvaters Bernhardiner Josef ist ein treuer Begleiter bei Heidis und Peters Abenteuern. Und er hilft seinen Freunden, wann immer es nötig ist. Doch am liebsten liegt der tapsige Müßiggänger faul in der Sonne und hält ein Nickerchen.

Heidi's Grandfather has a St. Bernard called Josef, who is a loyal companion on Heidi and Peter's adventures, and he helps them when they need it. But the gentle giant's favourite pastime is lazing around in the sun and napping.

Le Saint-Bernard Josef est un fidèle compagnon des aventures de Heidi et Peter. Il aide toujours ses amis quand ils ont besoin de lui. Mais ce que préfère ce paresseux, c'est s'allonger tranquillement au soleil pour faire une petite sieste.

El perro del abuelo, Niebla, es un fiel compañero de Heidi y Pedro en sus aventuras. Ayuda a sus amigos cuando lo necesitan. Eso sí, lo que más le gusta a este desmañado perezoso es dormir una siesta tumbado bajo el sol.





WARNING: CHOKING HAZARD

Small parts. Not for children under 3 years.

"Ne concerne que les USA"

Wichtige Unterlagen, bitte sorgfältig aufbewahren!
Important: Please keep these instructions for future reference!
Documents importants, à conserver soigneusement!
Belangrijke documenten, bewaar deze zorgvuldig!

Abbildungen können vom Original abweichen.
Product may differ from image shown.
Les illustrations peuvent différer de l'original.
Afbeeldingen kunnen verschillen van het werkelijke artikel.

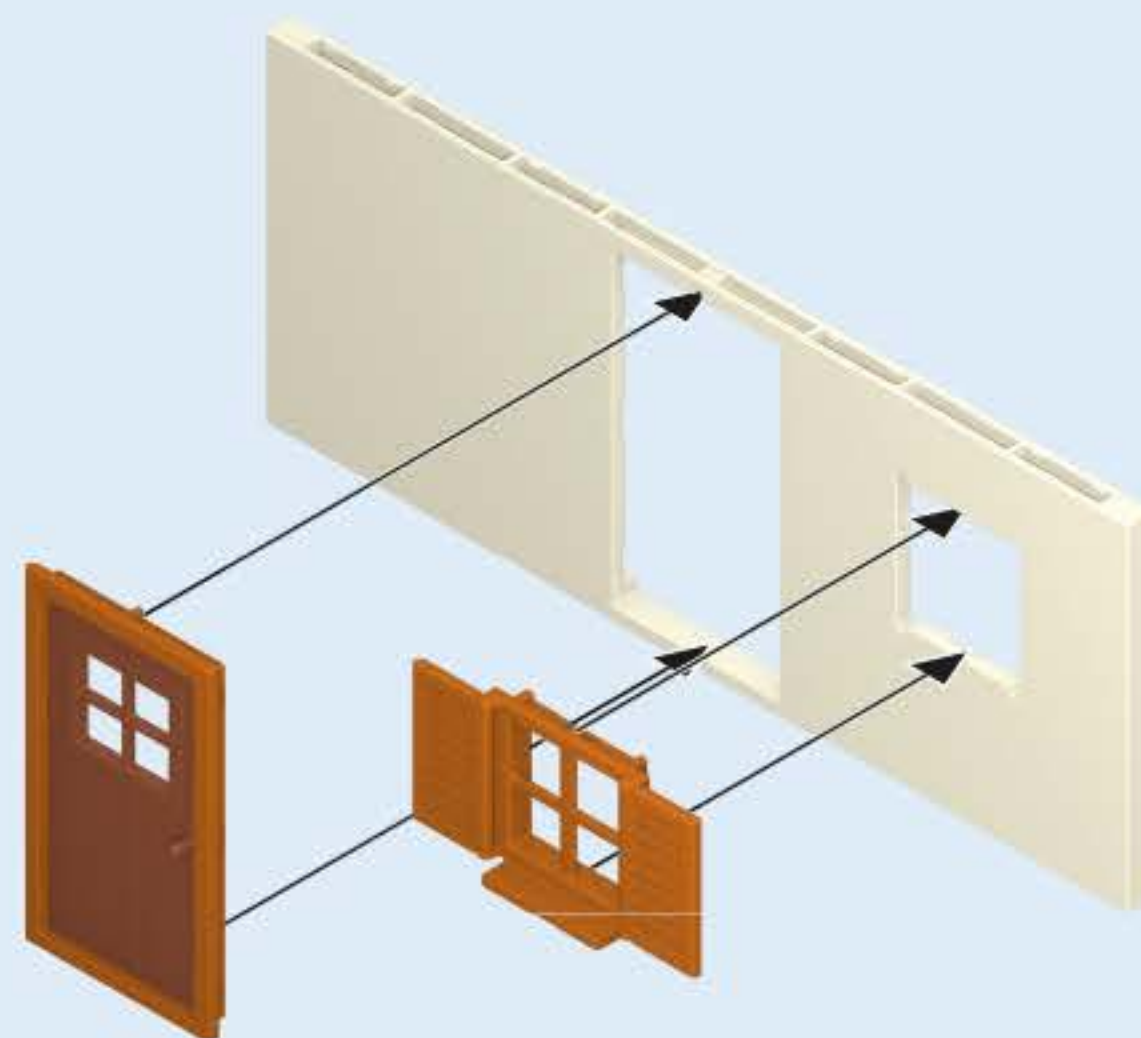
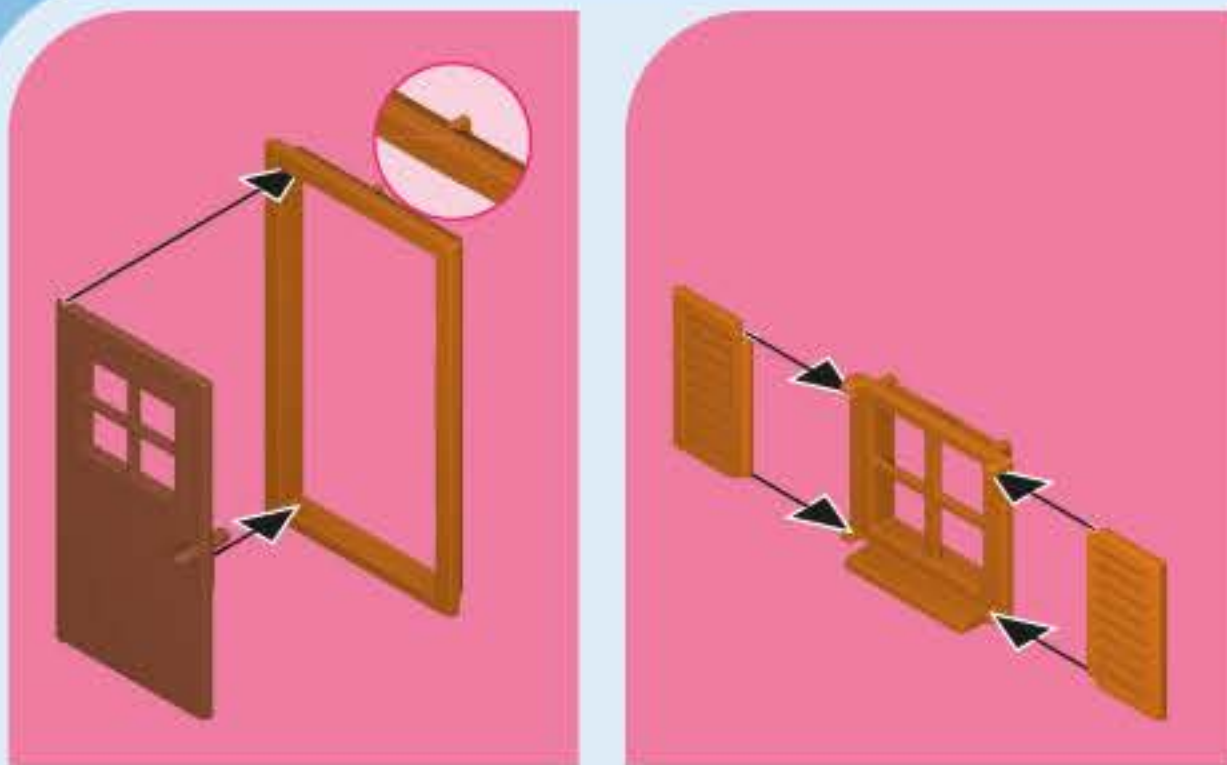
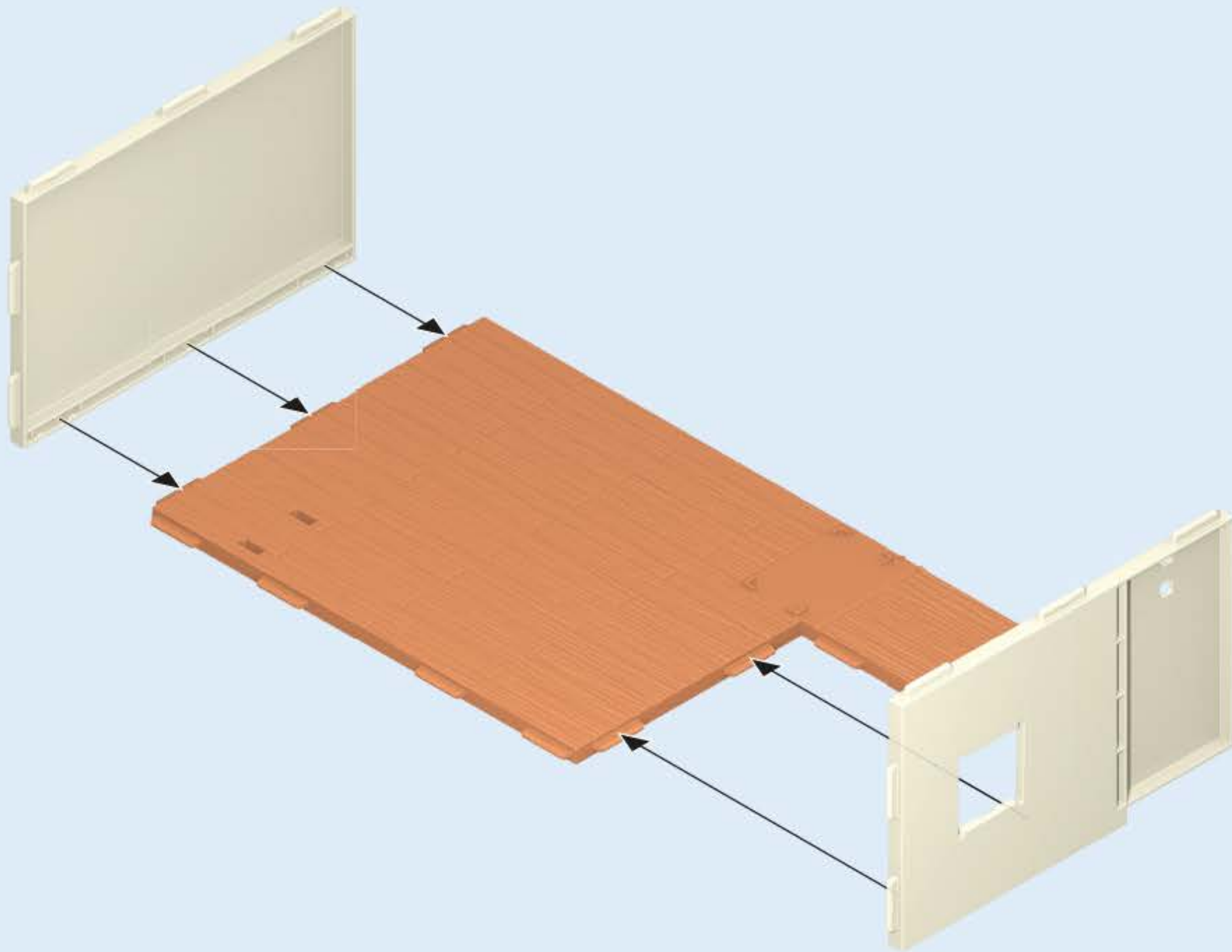

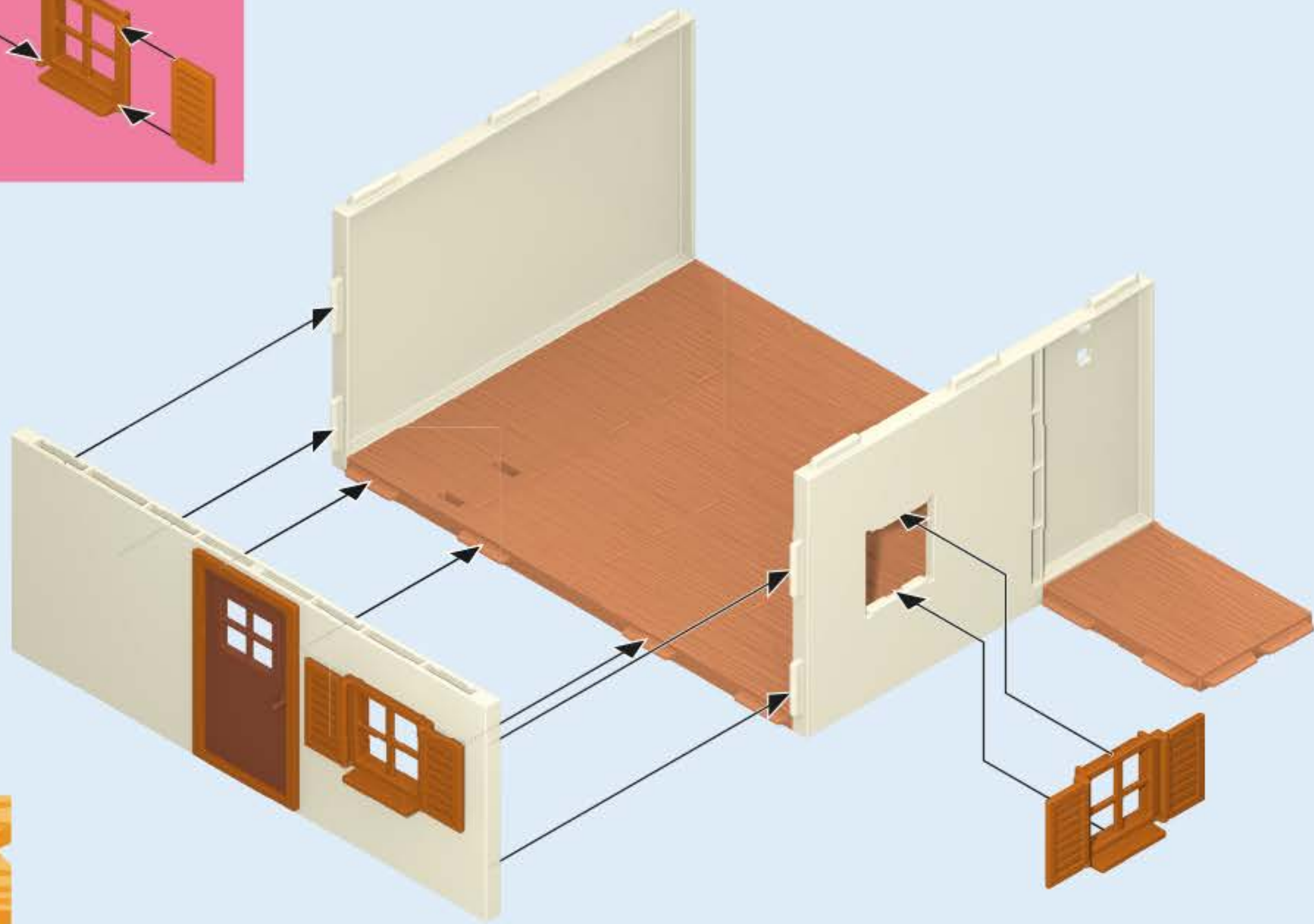
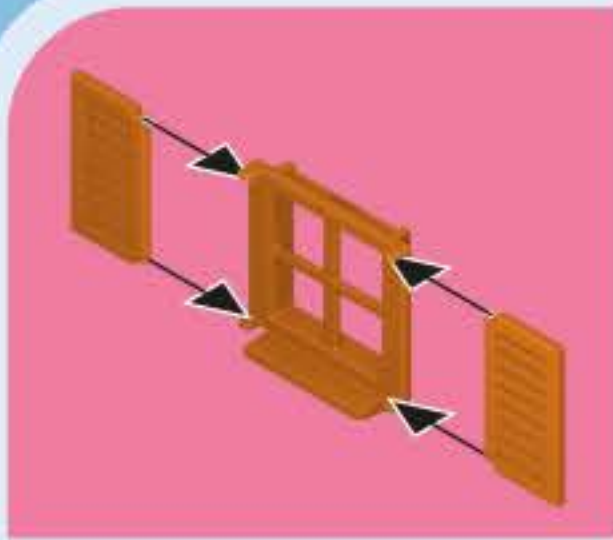

3

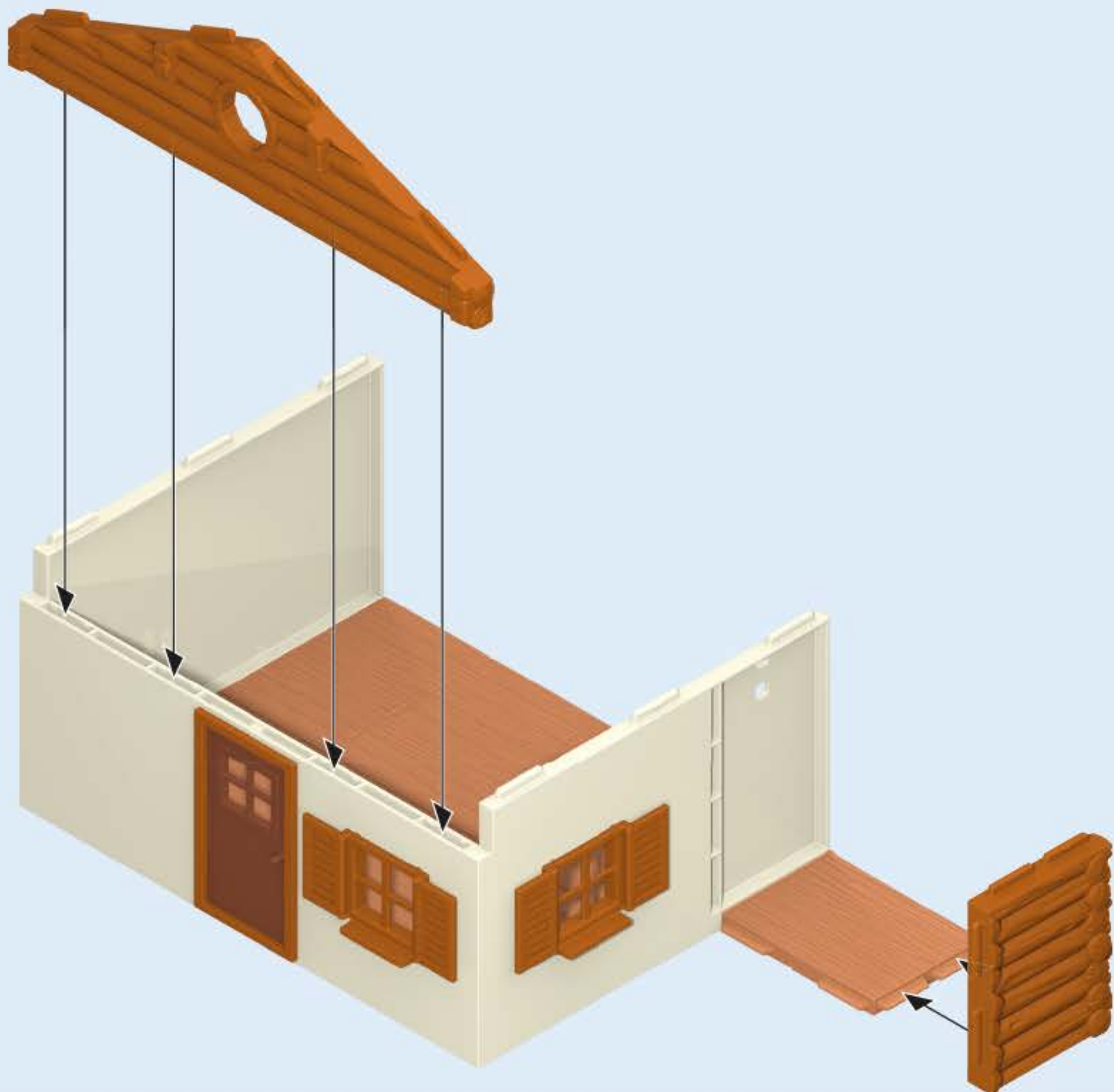

4

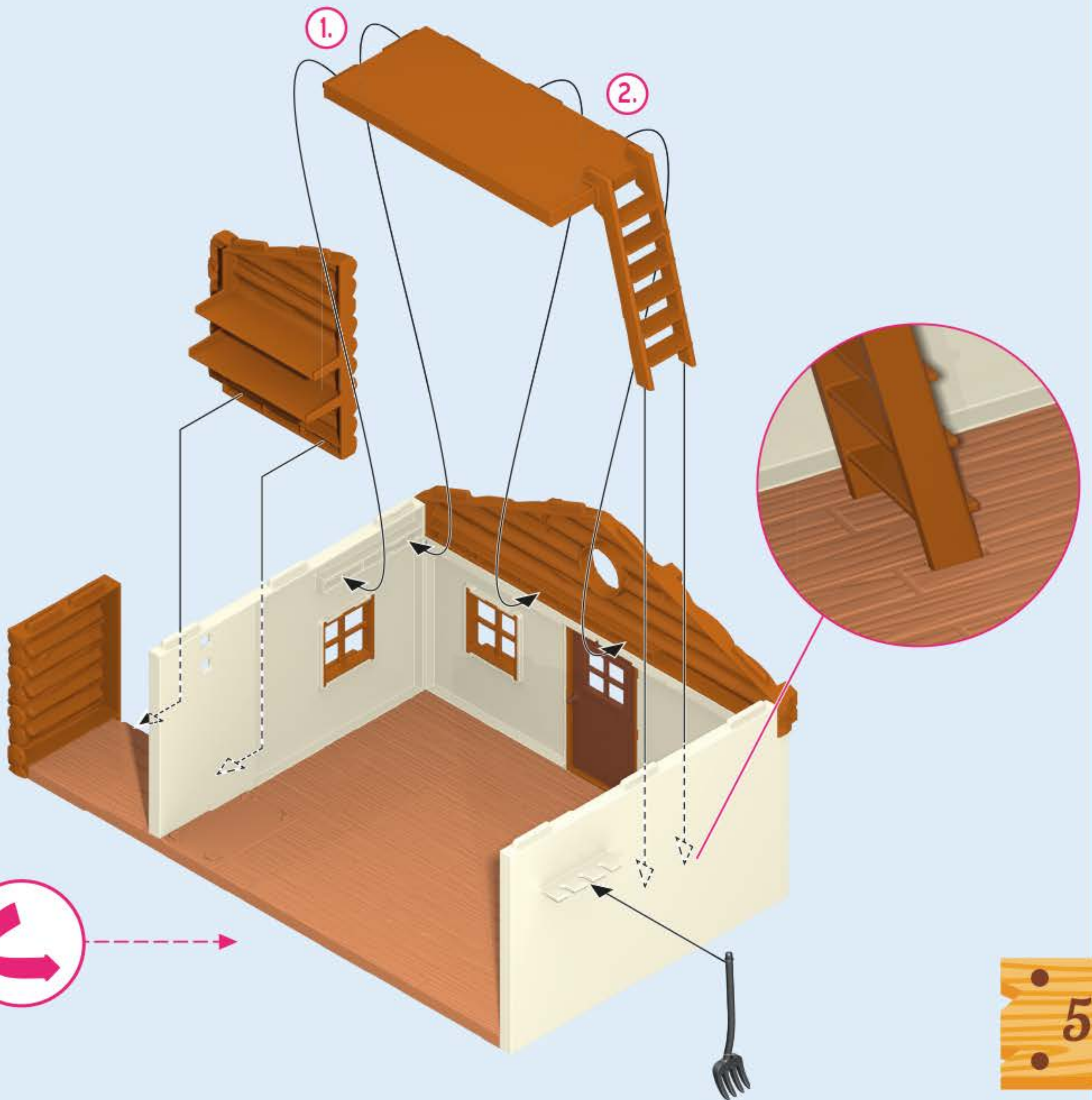
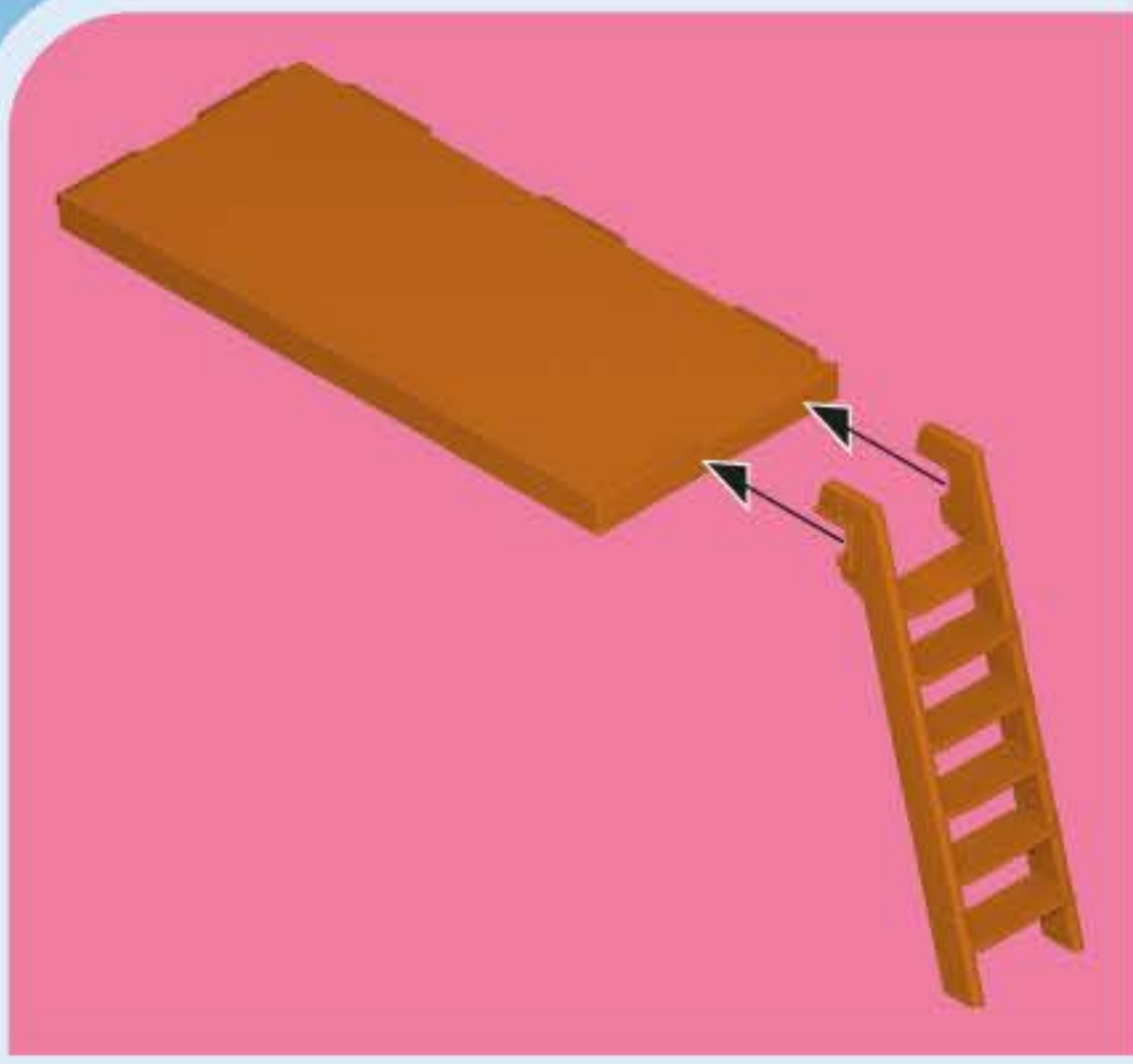

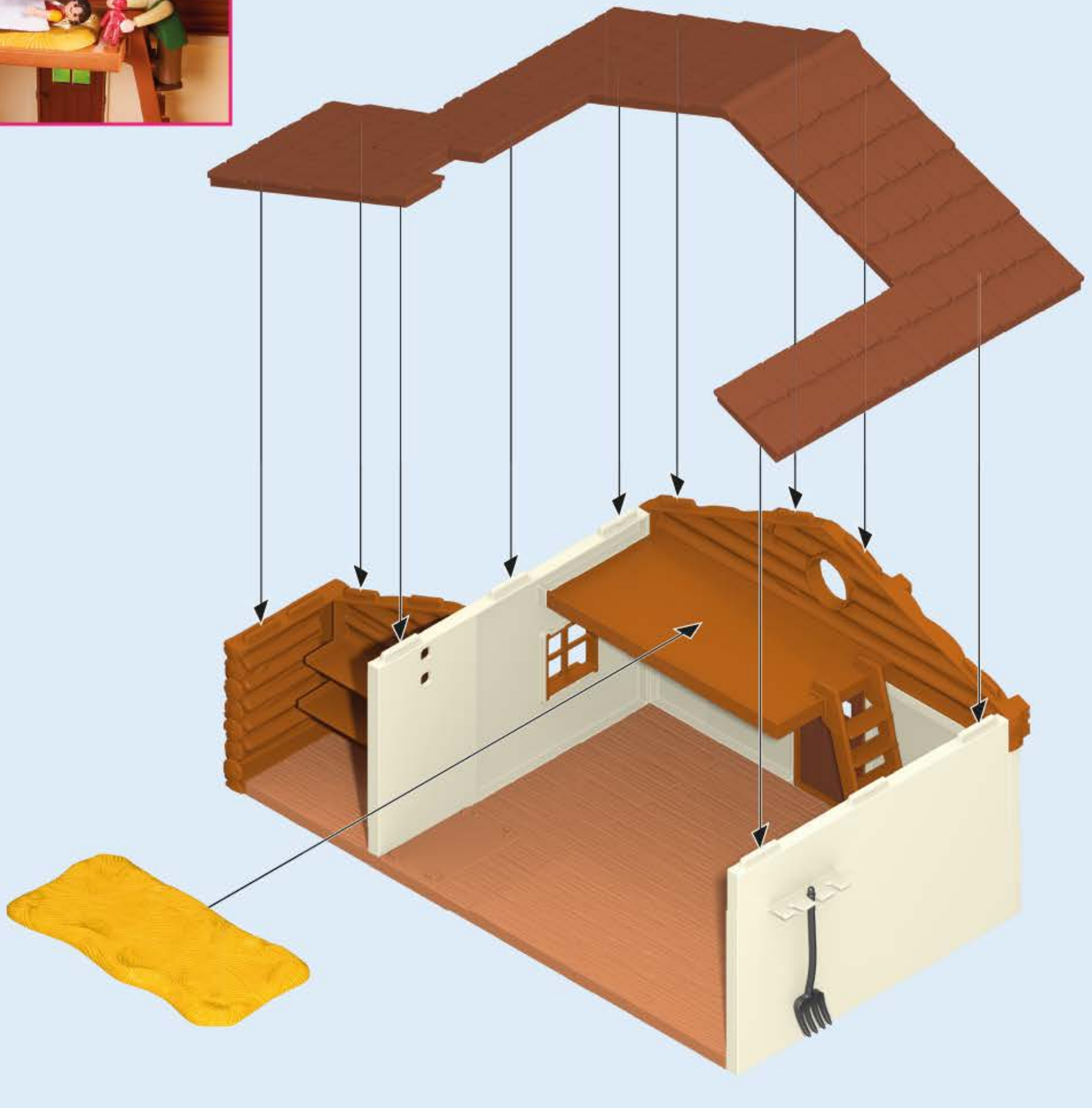
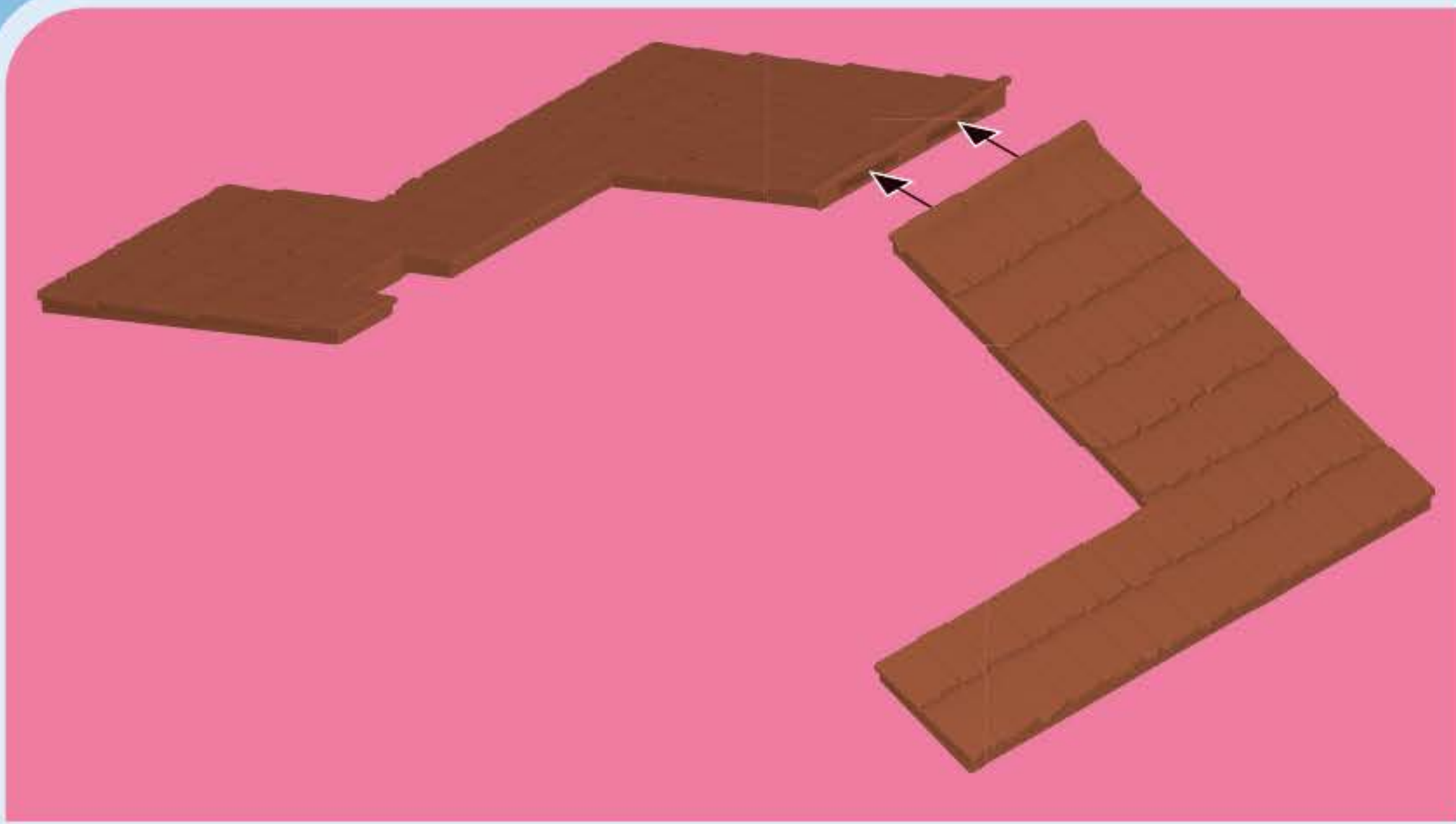

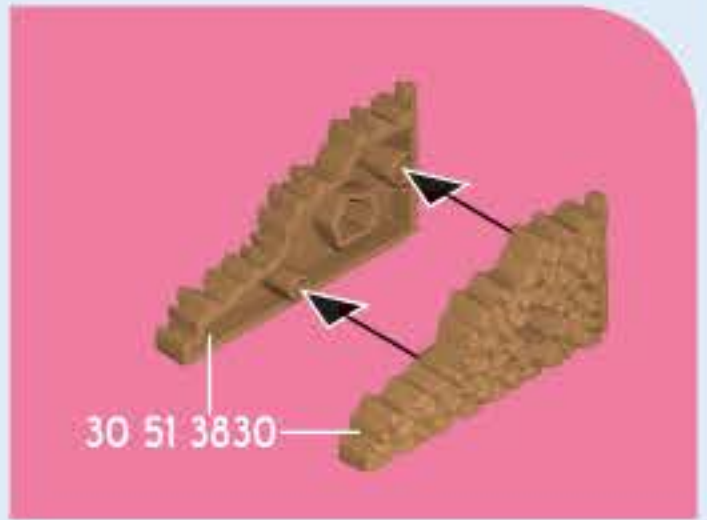
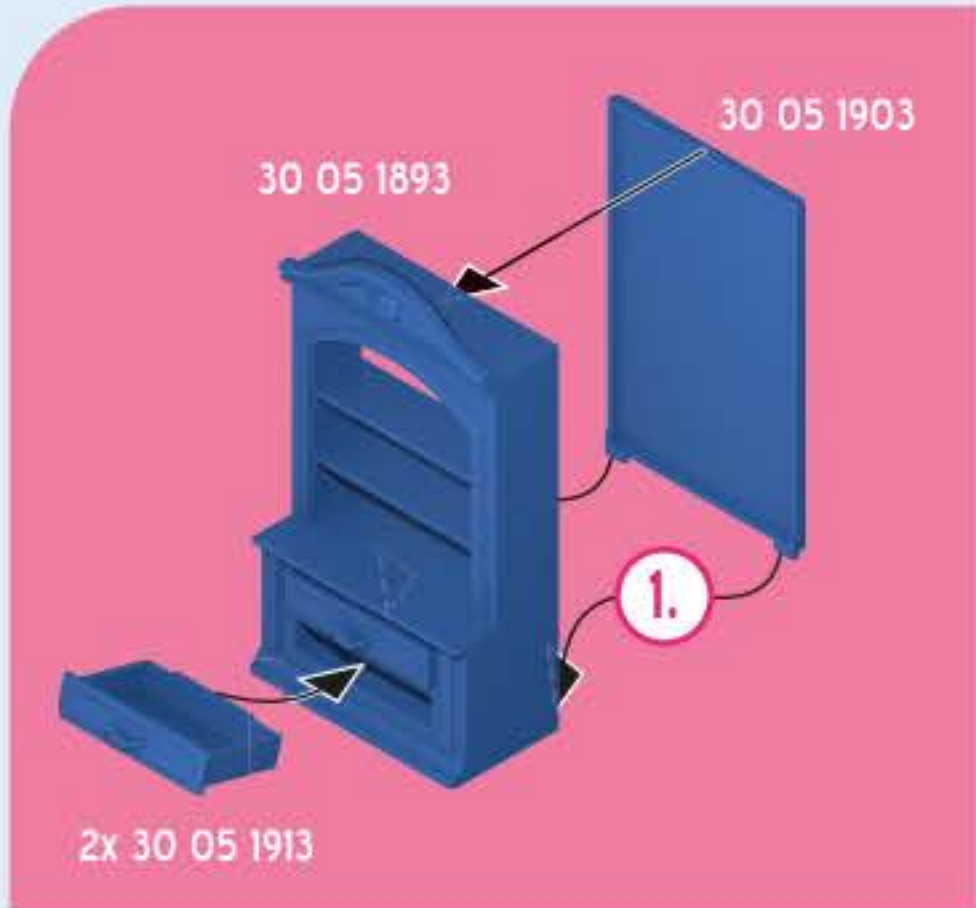
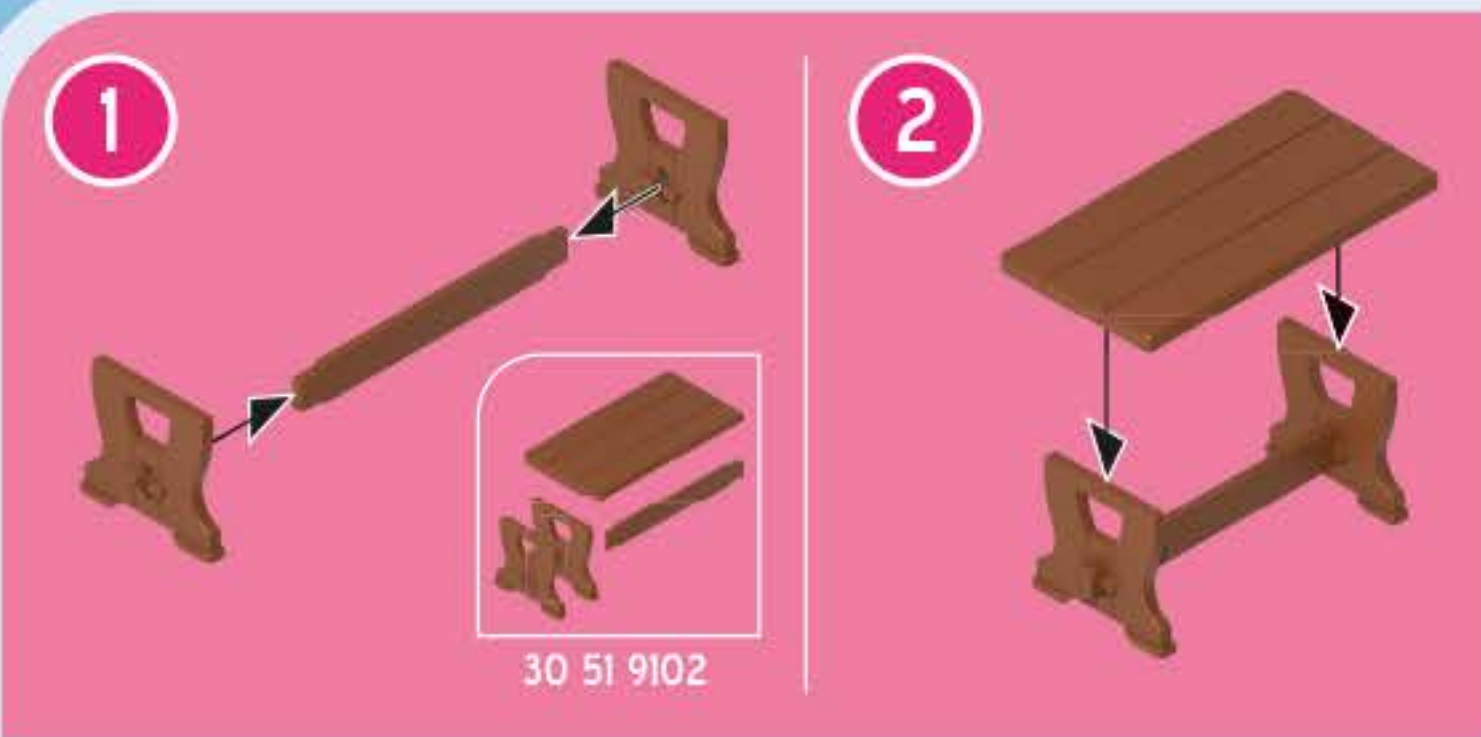
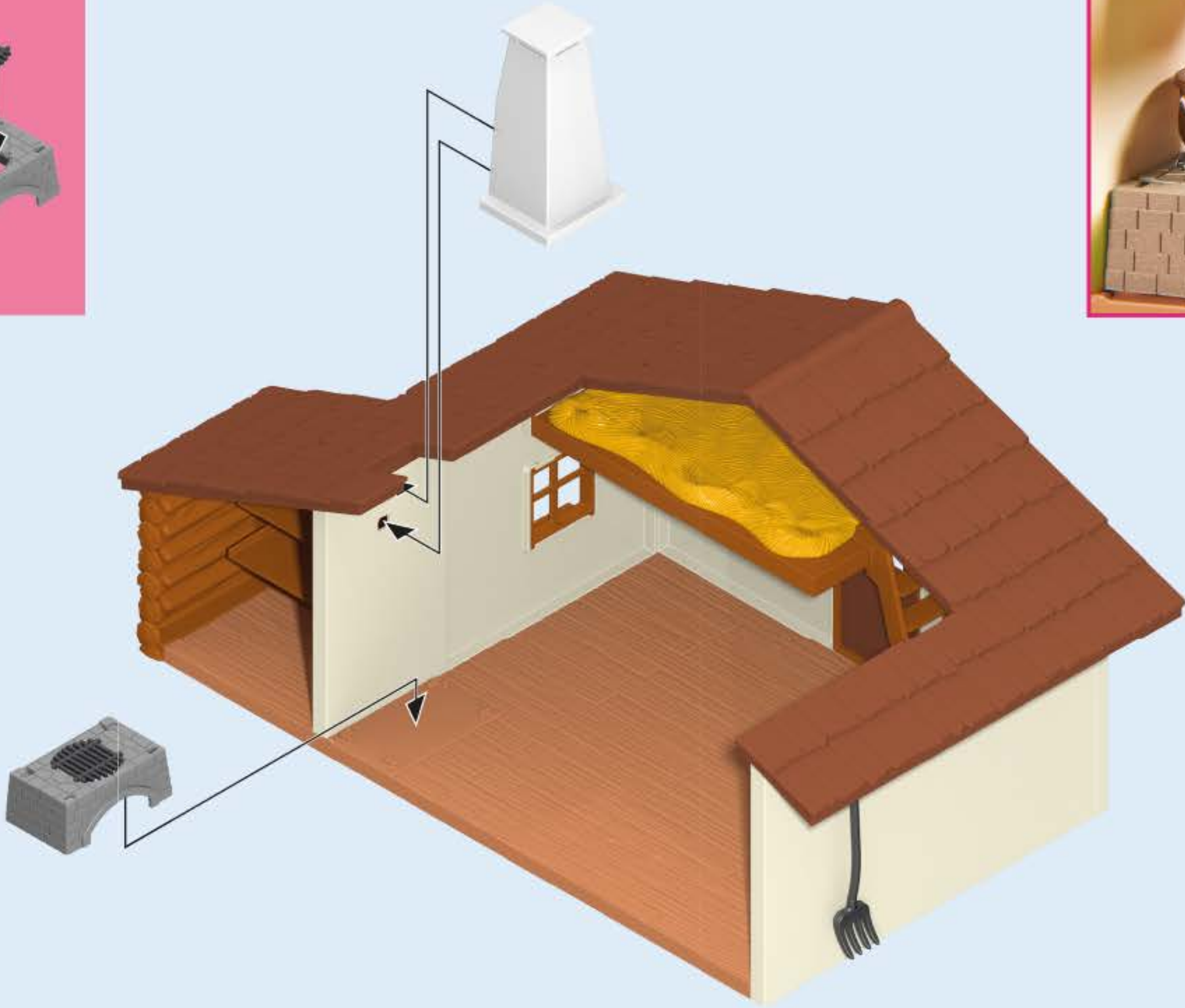

30 25 7330



30 26 5450

30 25 7340



30 25 7320

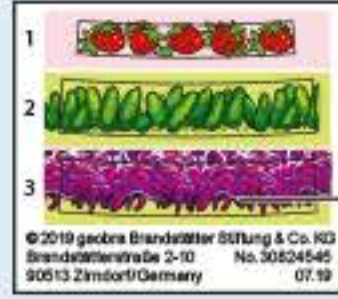

30 82 4545

2x 30 23 9203

2

3



30 22 0880

1



30 22 0890

30 05 1733



30 14 1742



30 00 4904

30 05 1673



30 11 4250

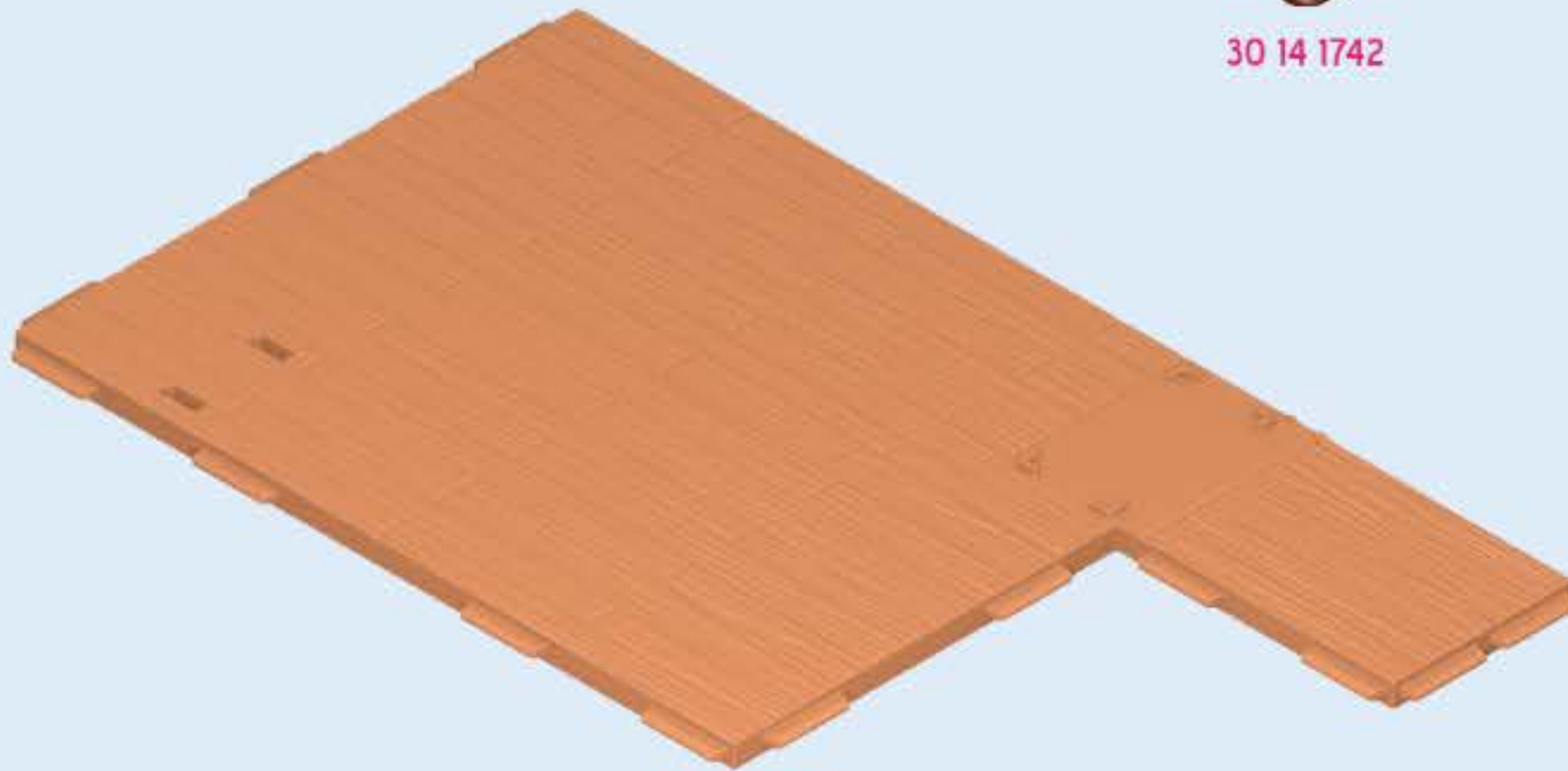

30 05 1973

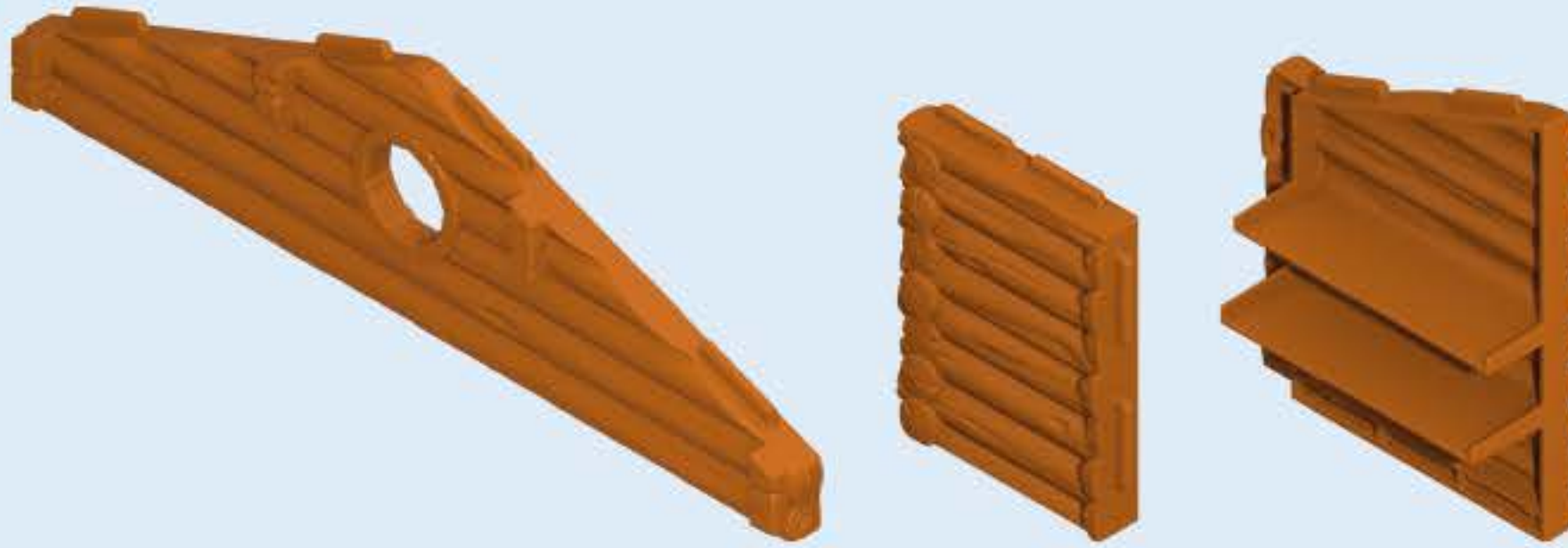

30 51 9632

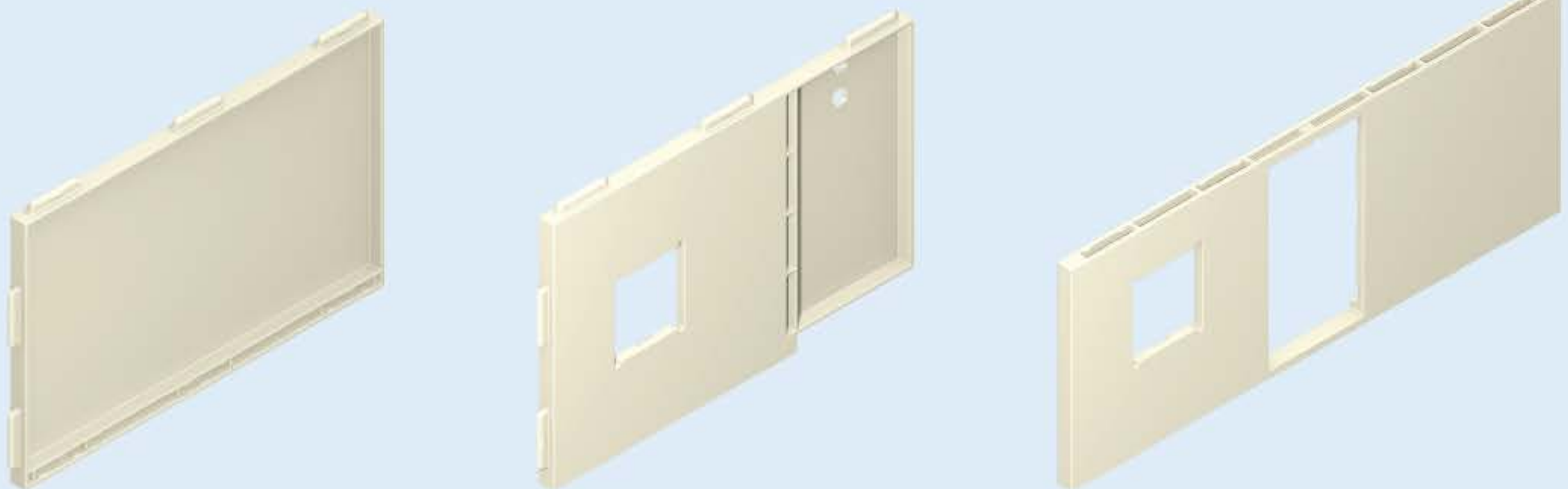

30 51 9622

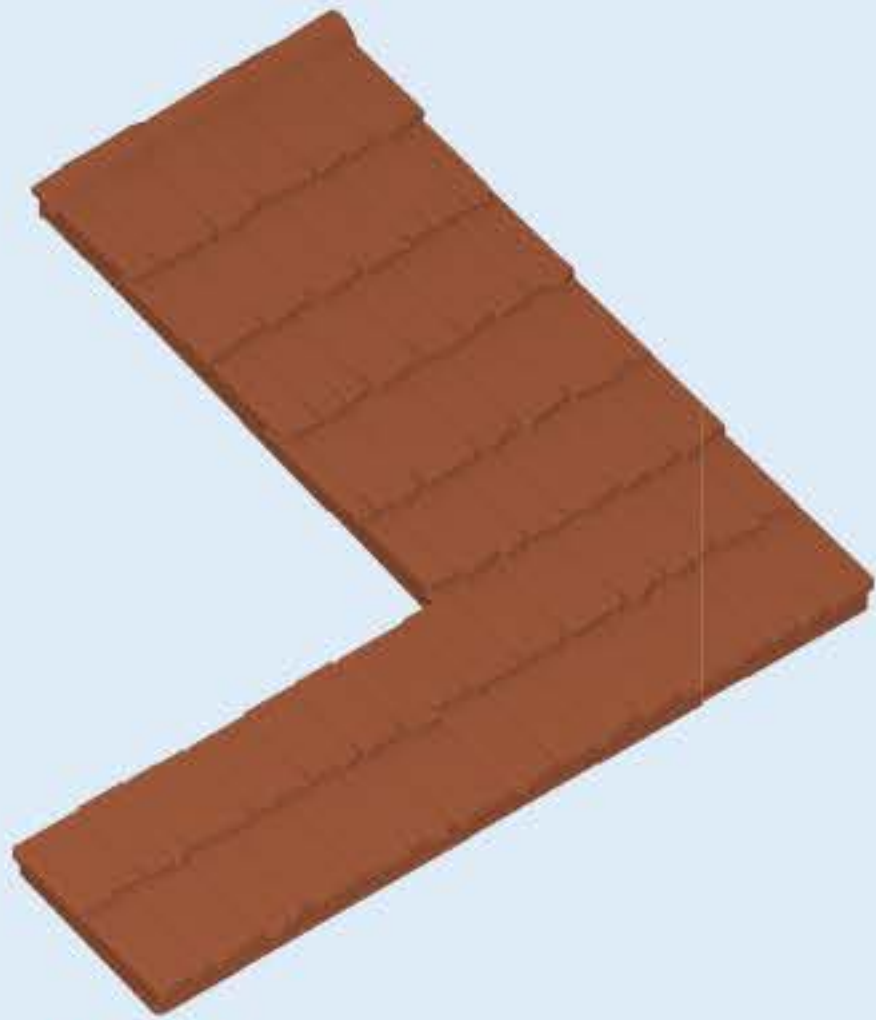

30 46 6052

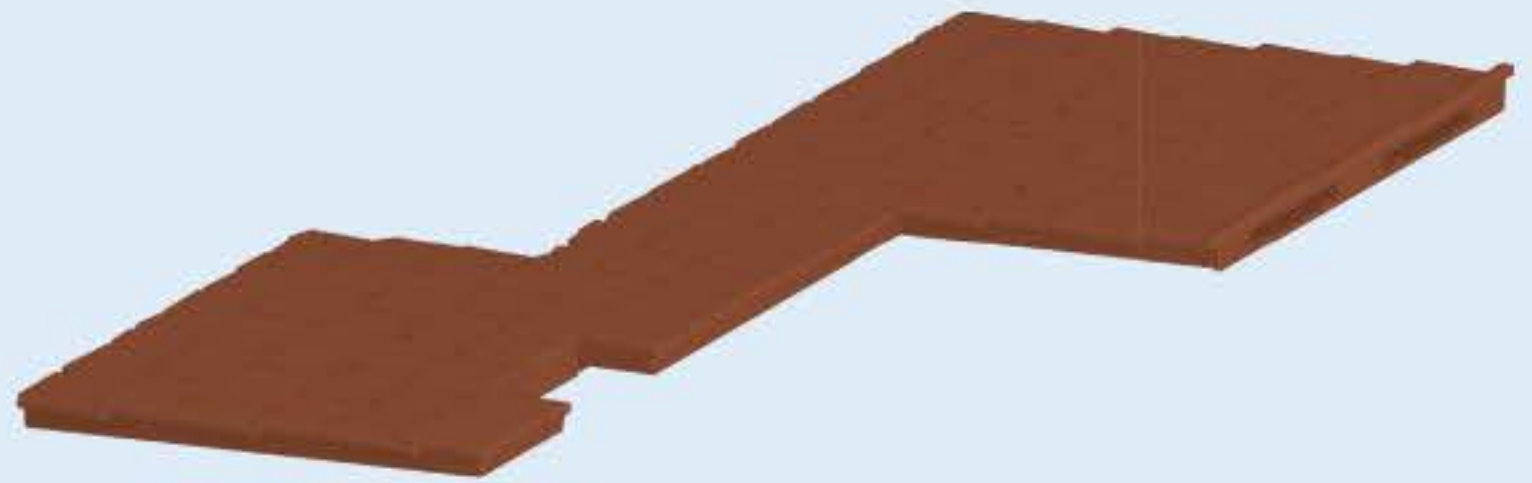

30 46 6962

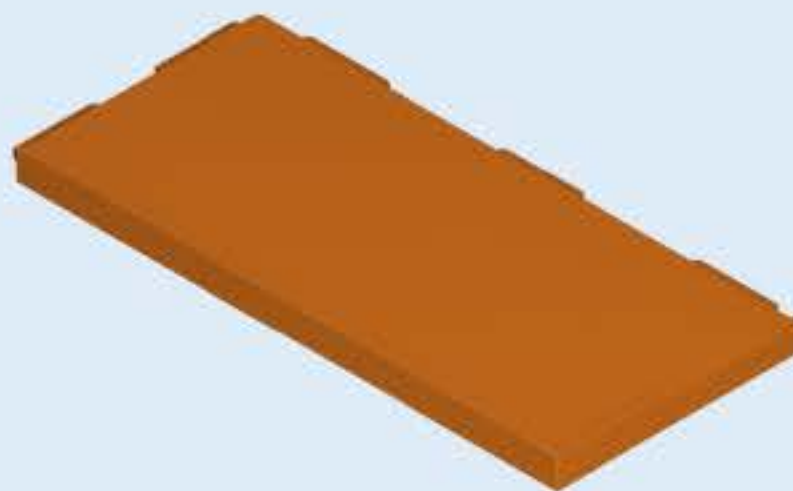

30 05 2033



30 24 1272



30 05 1963



30 05 2023



30 05 1983



30 05 1993



30 05 1803



30 05 1793



30 05 1783



2x 30 05 2003

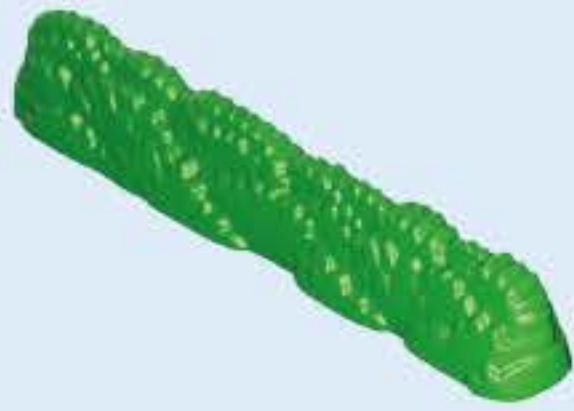

2x 30 09 5170

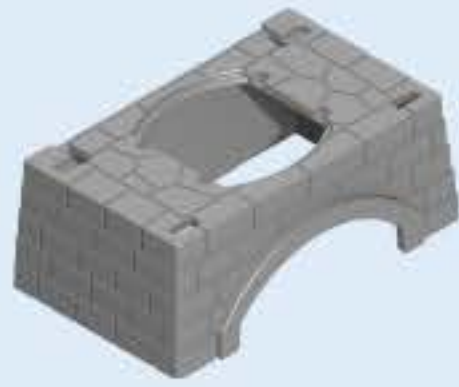

30 05 1943



2x 30 05 1933



30 05 1813



30 65 4984



2x 30 82 4605



4x 30 05 2013



30 02 8080



30 05 1773



30 05 1633



30 89 5372



30 89 5422



30 89 5552



30 89 5482



30 25 9812



30 25 7450



30 24 9210



3x 30 27 1750



2x 30 05 0790



30 20 8340



30 05 1823



3x 30 27 1760



2x 30 63 3042



30 28 7180



3x 30 22 9433



30 63 4116



30 20 9040



30 51 9612

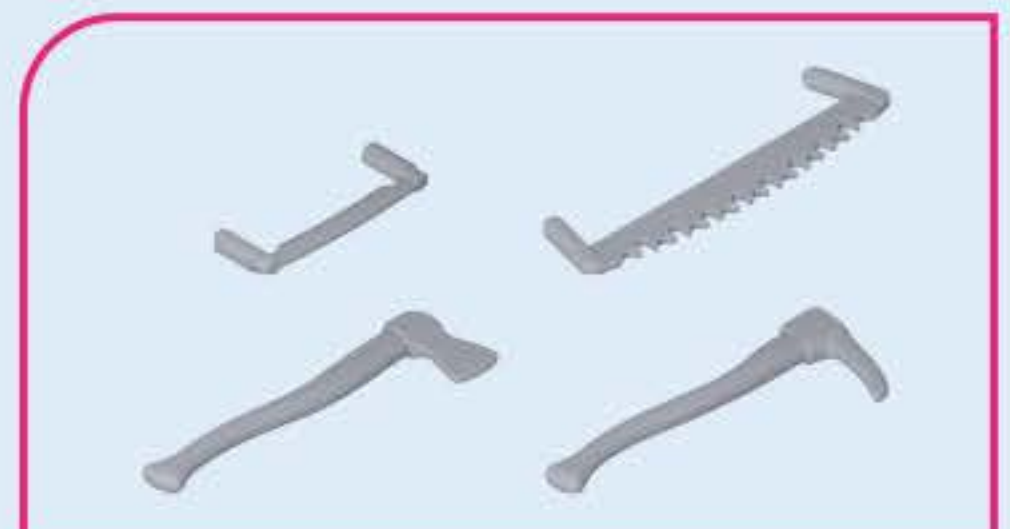

30 51 4870

Serviceadressen finden Sie in allen PLAYMOBIL-Prospekten.

Addresses of Customer Service Departments are shown in all PLAYMOBIL catalogues.

L'adresse du service consommateurs est indiquée dans tous les catalogues PLAYMOBIL.

Troverete gli indirizzi dei centri di assistenza in tutti i cataloghi PLAYMOBIL.

In alle PLAYMOBIL catalogi vindt u het adres van onze klantendienst.

Las Direcciones de los Departamentos de Servicio al Consumidor se encuentran en todos los catálogos PLAYMOBIL.

Η διεύθυνση του Γραφείου Εξυπηρέτησης Καταναλωτών PLAYMOBIL βρίσκεται σε όλους τους καταλόγους PLAYMOBIL.

pronounced: play-mō-bēil

70254



70257



70255



70256



~~70253~~



70258



playmobil®

© 2019 geobra Brandstätter Stiftung & Co. KG
Brandstätterstr. 2-10
90513 Zirndorf, Germany
No. 30 82 7145 07.19



Gehe auf ...

Go to ... / Rends-toi sur ... / Ve a ...

<https://surprise.playmobil.com>

... gib den Code ein und lass dich überraschen! / ... enter the code and be surprised! /
... saisis le code et laisse-toi surprendre! / ... introduce el código y sorpréndete!

Code:

30827145



Download on the
App Store

GET IT ON
Google Play

STUDIO 100

© Studio 100 Animation / Heidi Productions
™ Studio 100

www.studio100.com