

For further information, please go to [www.mi.com](http://www.mi.com)  
Manufactured for: Xiaomi Communications Co., Ltd.  
Manufactured by: Dreame (Tianjin) Information Technology Co., Ltd. (a Mi Ecosystem company)  
Address: Room 2112-1-1, South District, Finance and Trade Center, No.6975 Yazhou Road, Dongjiang Bonded Port Area, Tianjin Pilot Free Trade Zone, Tianjin, China

Importer:  
Beryko s.r.o.  
Na Roudné 1162/76, 301 00 Plzeň  
[www.beryko.cz](http://www.beryko.cz)

## Mi Robot Vacuum-Mop 2 Ultra Auto-empty Station User Manual



## Safety Information

Read this manual carefully before use, and retain it for future reference.

### Usage Restrictions

This product is for floor cleaning in a home environment only. Do not use it outdoors, on non-floor surfaces, or in a commercial or industrial setting.

This auto-empty station is only used with Vacuum-Mop STYTJ05ZHMHW.

This appliance can be used by children aged from 8 years and above and persons with reduced physical, sensory or mental capabilities or lack of experience and knowledge if they have been given supervision or instruction concerning use of the appliance in a safe way and understand the hazards involved. Children shall not play with the appliance. Cleaning and user maintenance shall not be made by children without supervision.

This product is not a toy. Ensure children and pets are kept at a safe distance from the auto-empty station while it is operating.

If the power cord is damaged, it must be replaced by a special cord or assembly available from the manufacturer or its service agent.

The auto-empty station should be placed in an open area instead of places suspended above ground level like stairs.

Do not move the auto-empty station by using its top cover as a handle.

Do not stand or sit on the auto-empty station.

Do not pour any liquid into the auto-empty station or immerse it in water.

Do not use the auto-empty station without the disposable bag installed.

Do not use the vacuum-mop at an ambient temperature above 40°C or below 0°C or on a floor with liquids or sticky substances.

Do not install, charge, or use this auto-empty station outdoors, in bathrooms, or near a pool.

Do not place children, pets, or any item on top of the auto-empty station while it is stationary or operating.

Make sure the auto-empty station is unplugged before cleaning or performing maintenance.

Do not stick your fingers into the gaps on the auto-empty station to avoid injury.

Do not place any objects on the auto-empty vents.

Make sure the vacuum-mop is turned off when being transported and kept in its original packaging if possible.

Please use this product in accordance with the instructions in the User Manual. Users are responsible for any loss or damage arising from improper use of this product.

## Charging

Make sure the voltage of the power supply you use is consistent with the voltage indicated on this auto-empty station.

Do not dismantle, repair, or modify the auto-empty station on your own.

Do not place the auto-empty station near heat sources.

Do not use a wet cloth or wet hands to wipe or clean the charging contacts of the auto-empty station.

If the power cord becomes damaged or broken, stop using it immediately and contact after-sales service.

Unplug the auto-empty station if it will not be used for an extended period.

## EU Declaration of Conformity

**CE** We, Dreame (Tianjin) Information Technology Co., Ltd., hereby, declare that this equipment is in compliance with the applicable Directives and European Norms, and amendments. The full text of the EU declaration of conformity is available at the following internet address:

<http://www.mi.com/global/service/support/declaration.html>

For detailed e-manual, please go to [www.mi.com/global/service/userguide](http://www.mi.com/global/service/userguide)

## Product Overview

### Package Contents

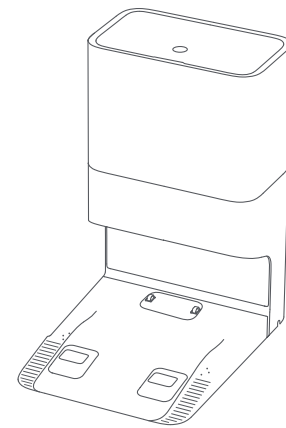

Auto-empty Station  
(Disposable Bag Pre-installed)

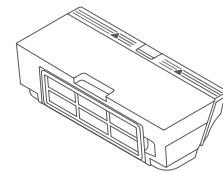

Auto-empty Dust Compartment



Power Cord



Disposable Bag  
(Replacement)



User Manual

### Notes:

- Illustrations of product, accessories, and user interface in the user manual are for reference purposes only. Actual product and functions may vary due to product enhancements.
- The vacuum-mop used with this auto-empty station is sold separately. For details on how to use and maintain the vacuum-mop, refer to the vacuum-mop user manual.
- To use this auto-empty station, the auto-empty dust compartment must be installed in the vacuum-mop.

## Auto-empty Station

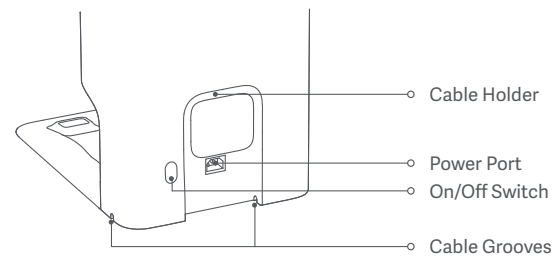
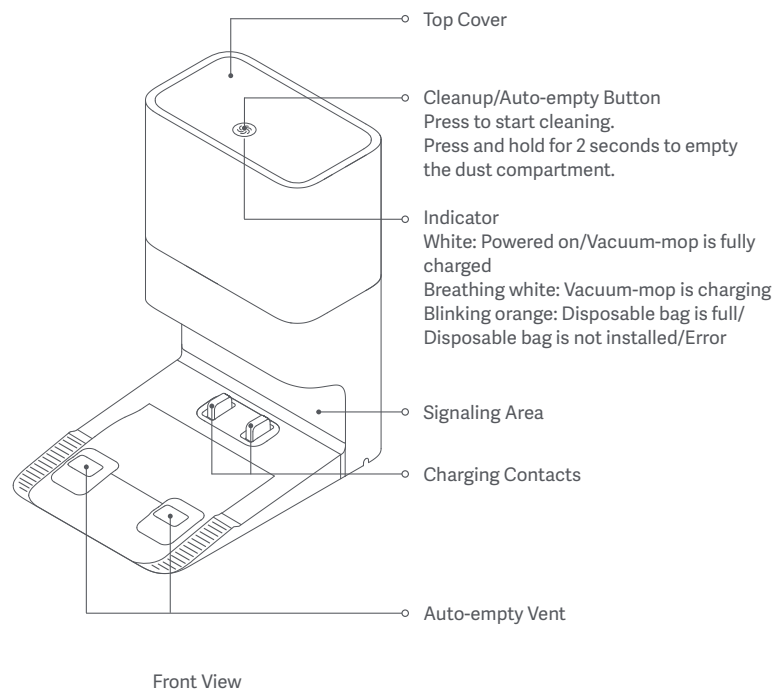

Back View

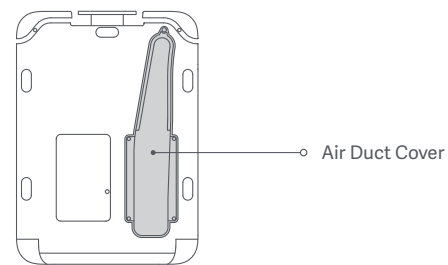

Bottom View

## Auto-empty Station (Top Cover Opened)

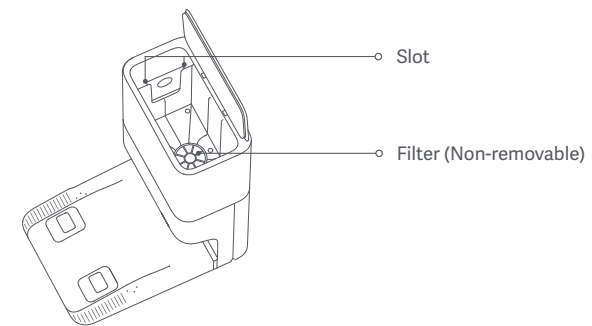

## Disposable Bag

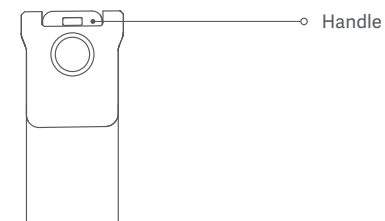

**Note:** The auto-empty station is pre-installed with a disposable bag when leaving the factory.

## Auto-empty Dust Compartment

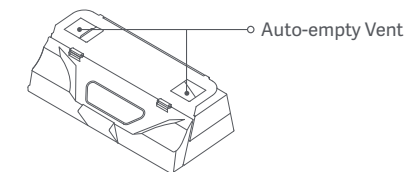
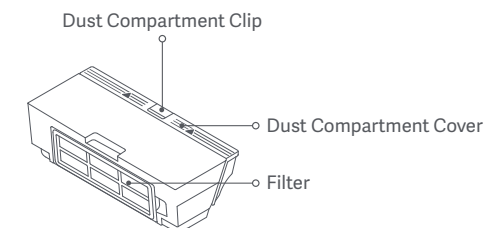

## Installation

1. Remove the original dust compartment from the vacuum-mop.

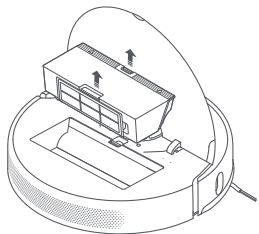

2. Install the auto-empty dust compartment.

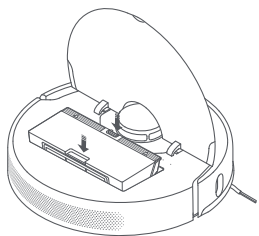

3. Put away the original charging dock.

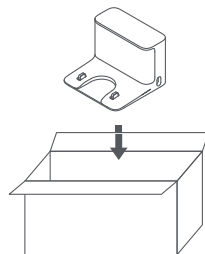

4. Install the auto-empty station.

- Place the auto-empty station in an open area with a good Wi-Fi signal.
- Use the cable holder and cable grooves to organize the power cord.

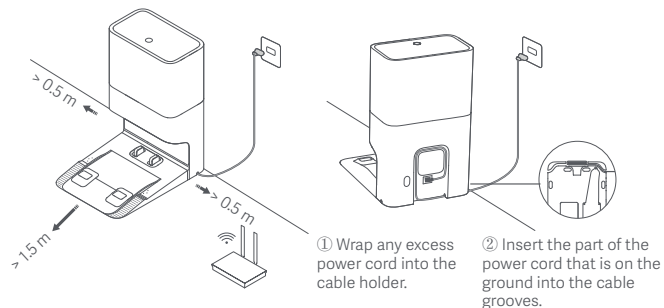

## How to Use

### Turning on and charging

- Plug in the auto-empty station and turn it on. The indicator on the auto-empty station will turn white.
- Manually place the vacuum-mop onto the auto-empty station, the vacuum-mop turns on automatically and starts to charge.
- Once the vacuum-mop is fully charged, the indicator on the auto-empty station will remain white for 10 minutes, and then go off.

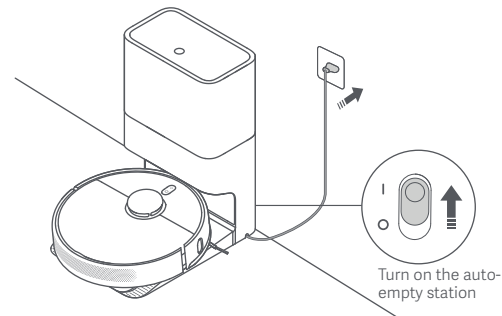

### Notes:

- Push the switch to the mark of "I", the auto-empty station is turned on; push the switch to "O", the auto-empty station is turned off.
- The auto-empty station cannot function if it is not plugged in or not turned on.

### Start cleaning

Press the button , the vacuum-mop will leave from the auto-empty station to start cleaning.

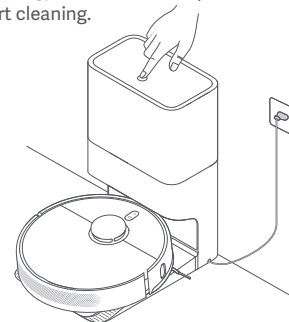

### Notes:

- Before using this feature, make sure the auto-empty station is turned on and the vacuum-mop is connected to it.
- To ensure the vacuum-mop can easily return to the auto-empty station after cleaning, allow the vacuum-mop to start from the auto-empty station, and avoid moving the auto-empty station during a cleaning task.

### Empty the dust compartment

When the vacuum-mop has finished a cleaning task, it will return to the auto-empty station to charge. The auto-empty station will then automatically start to empty the dust compartment.

### Notes:

- If the dust auto-empty feature is disabled in the app, the auto-empty station will not automatically empty the dust compartment.
- If the auto-empty frequency is modified in the app, the auto-empty station will empty the dust compartment according to the configured frequency.
- If the auto-empty station does not empty the dust compartment automatically, you can press and hold the button  on the auto-empty station for 2 seconds to make it start.

## Care & Maintenance

### Cleaning the auto-empty dust compartment

(weekly cleaning is recommended)

1. Open the top cover of the vacuum-mop, and press the dust compartment release button to remove the auto-empty dust compartment upwards.

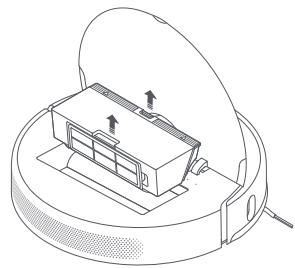

2. Open the dust compartment and empty its contents, and then wipe the auto-empty vents clean with a cloth.

**Note:** To prevent the filter from becoming clogged, lightly tap the dust compartment when emptying its contents.

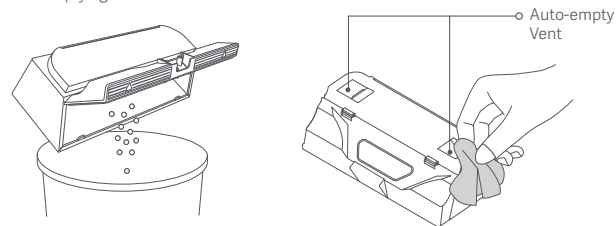

3. Add clean water to the dust compartment, and close the dust compartment cover, then shake the compartment back and forth, finally pour out the water.

**CAUTION:** Only clean water should be used to clean the filter. Do not use detergent.

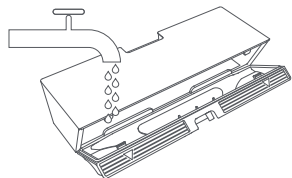

4. Remove the filter, as illustrated, then rinse it out and lightly tap on the edge of the filter to remove dust and debris.

#### Notes:

- Do not attempt to clean the filter with a brush or finger.
- Biweekly cleaning is recommended.
- Filter must be fully dry before use.

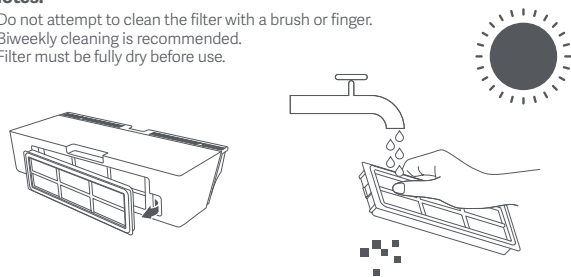

### Replacing the disposable bag

When the disposable bag needs to be replaced, the indicator on the auto-empty station will blink orange, and a notification will appear in the app.

1. Open the top cover of the auto-empty station, pull the handle upwards to remove it, and then discard the disposable bag.

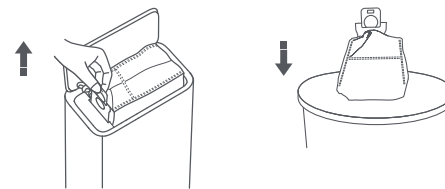

**Note:** Pulling upwards on the handle will seal the disposable bag to prevent the dust and debris from accidentally falling out.

2. Remove the dust and debris from the filter with a dry cloth.

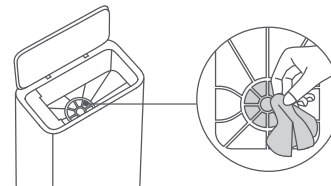

3. Insert the board into the slot, and make sure it is installed securely in place.

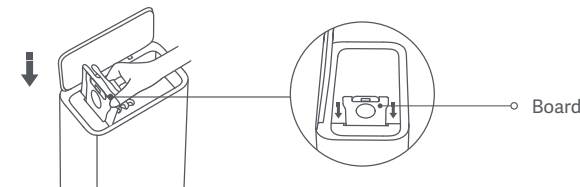

4. Press down on the top cover of the auto-empty station to make sure it is completely closed.

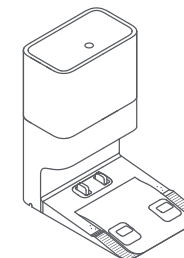

## Cleaning the air duct on the auto-empty station

(clean it as needed)

If the air duct is blocked, follow the steps below to clean it.

1. Unscrew the air duct cover to remove it.

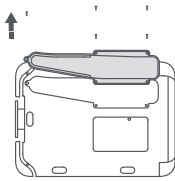

2. Check whether the air duct is blocked by foreign objects, and remove the objects if necessary.

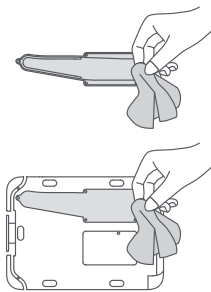

3. Install the air duct cover back and screw it.

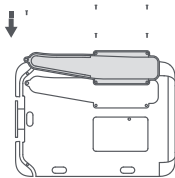

## Cleaning the charging contacts and the auto-empty vents

(clean them as needed)

Clean the charging contacts and the auto-empty vents with a soft, dry cloth.

**Warning:** Make sure the auto-empty station is turned off and unplugged before cleaning.

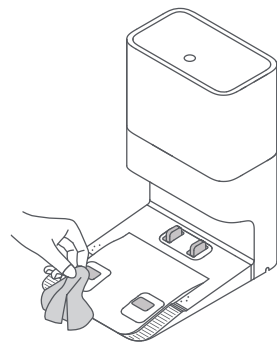

## Troubleshooting

Issue	Possible Cause and Solution
The vacuum-mop cannot return to the auto-empty station.	There are too many obstructions around the auto-empty station. Place the auto-empty station in a more open area. Clean the signaling area of the auto-empty station. Moving the vacuum-mop may cause it to re-position itself, and it will recreate a map if re-positioning fails. If the vacuum-mop is too far from the auto-empty station, it might not be able to automatically return on its own, in which case you will need to manually place the vacuum-mop onto the auto-empty station.
The dust auto-empty process does not start after the vacuum-mop returns to the auto-empty station.	Make sure both ends of the power cord are plugged in correctly and the auto-empty station is turned on. During the do-not-disturb periods of the vacuum-mop, the auto-empty station will not automatically empty the dust compartment. The auto-empty station may not automatically empty the dust compartment if the auto-empty feature is disabled or the auto-empty frequency is modified in the app.
The vacuum-mop does not start cleaning when pressing the cleanup/auto-empty button.	Make sure both ends of the power cord are plugged in correctly and the auto-empty station is turned on. Make sure the vacuum-mop is properly connected to the auto-empty station.
The indicator on the auto-empty station blinks orange.	Check whether the disposable bag is full, and replace it immediately if needed. Check to make sure the disposable bag is installed properly. See the instructions in the user manual for installation. Check whether the auto-empty vents on the auto-empty station are dirty, and clean them immediately if necessary. Check whether the air duct on the bottom of the auto-empty station is clogged, and clean it immediately if necessary.
It takes longer than usual to empty the dust compartment.	If the auto-empty station detects its air duct clogged, it may take longer than usual to empty the dust compartment. Clean the air duct immediately if necessary. After the auto-empty station has been used for a while, the auto-empty process may take slightly longer to ensure its function runs smoothly. This is normal.

## Specifications

Model	STYTJ05ZHMHWJC
Dimensions	285 × 397 × 468 mm
Rated Input	220-240 V ~ 50/60 Hz
Rated Output	19.8 V --- 1 A
Rated Power	1000 W

## WEEE Disposal and Recycling Information



All products bearing this symbol are waste electrical and electronic equipment (WEEE as in directive 2012/19/EU) which should not be mixed with unsorted household waste. Instead, you should protect human health and the environment by handing over your waste equipment to a designated collection point for the recycling of waste electrical and electronic equipment, appointed by the government or local authorities. Correct disposal and recycling will help prevent potential negative consequences to the environment and human health. Please contact the installer or local authorities for more information about the location as well as terms and conditions of such collection points.