

K'nex®

MECHA STRIKE™
Roller Coaster
Building Set

GREVE DE MECHA™
Montagnes Russes
Jeu de construction

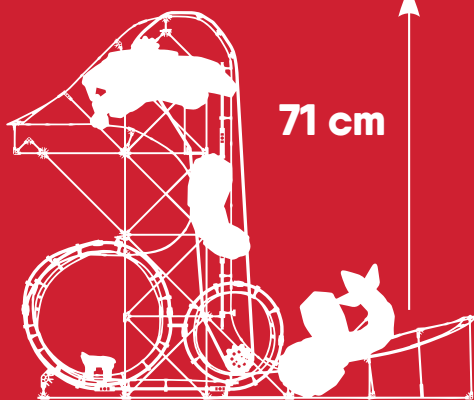

MOTOR ⚡ MOTEUR®

AA (LR6) AA (LR6)

Not Included/Pas Inclus⁽²⁾

Ages

9-14

18515

THRILL RIDES



(EN) English

Keep this important information for future reference

WARNING: CHOKING HAZARD – Small parts. Not for children under 3 years.

CAUTION: Keep hands, face, hair and clothing away from all moving parts.

CAUTION: Be careful not to tip the model over. Model should be placed on a flat and hard surface.

Do not obstruct track with objects or any part of your body.

Battery Information

How to Insert and Remove Batteries

Use a small Phillips head screwdriver to loosen the screw. Insert 2 fresh AA batteries** (LR6) into the compartment with the correct polarity (+/-) as shown here. Install batteries before building models.

** Not included

CAUTION: To Avoid Battery Leakage

- Insert batteries with correct polarity (+/-) as shown.
- Do not mix different types of batteries.
- Do not mix alkaline, standard (carbon-zinc) or rechargeable batteries.
- Do not mix new and used batteries. Only batteries of the same or equivalent type recommended should be used.
- Remove exhausted batteries from the toy; do not short-circuit supply terminals.
- Remove all batteries if the toy will not be used for a long period of time.

Important Tips

- Alkaline batteries are recommended.
- Rechargeable batteries are not recommended.
- Remove rechargeable batteries before recharging; they must be charged only under adult supervision.
- Non-rechargeable batteries must not be recharged.
- Keep components free of dust; do not immerse or use in water.
- Do not dispose of batteries in a fire; they could leak or explode and cause injury.



The wheelie bin indicates this product cannot be disposed of with household waste due to presence of hazardous substances.

To protect human health and environment, check your local authority for recycling advice and facilities (2012/19/EU, Europe only).

(FR) Français

Gardez précieusement cette notice pour vous y référer ultérieurement

ATTENTION : RISQUE D'ÉTOUFFEMENT – Pièces de petite taille. Ne convient pas aux enfants de moins de 3 ans.

ATTENTION : Garde les cheveux, les doigts, la figure et les vêtements à l'écart de toutes les pièces mobiles.

ATTENTION : Faire attention de ne pas renverser le modèle. Le modèle devrait être placé sur une surface plate et dure.

Ne pas bloquer les rails avec des objets ou la corps.

Informations sur les Piles

Comment mettre et retirer des piles

Utiliser un petit tournevis pour desserrer la vis et pour enlever le couvercle des piles. Insérer 2 piles AA (LR6)** neuves dans le compartiment en respectant la polarité (+/-). Installe les piles avant de réaliser tes constructions.

** Pas inclus

ATTENTION : Pour éviter la fuite des piles

- Insérez les piles en respectant la polarité (+/-) comme indiqué.
- Ne pas mélanger différents types de piles.
- Ne pas mélanger des piles alcalines avec des piles standard (carbone-zinc), ou des piles rechargeables.
- Ne pas mélanger des piles neuves avec des piles usées. Il convient d'utiliser uniquement des piles du type recommandé ou d'un type équivalent.
- Retirer toujours les piles faibles ou mortes du produit ; ne pas faire court-circuiter les terminaux.
- Retirez toutes les piles si le jouet ne sera pas utilisé pendant une longue période de temps.

Conseils Importants

- Les piles alcalines sont recommandées.
- Les piles rechargeables ne sont pas recommandées.
- Retirer les piles rechargeables du jouet avant de les recharger; elles doivent être chargées exclusivement en présence d'un adulte.
- Les piles qui ne sont pas rechargeables ne doivent pas être rechargées.
- Veiller à ce que les éléments restent à l'abri de la poussière ; ne pas les plonger ni les utiliser dans l'eau.
- Ne pas jeter les piles dans le feu ; elles risqueraient de fuir ou d'exploser et d'entraîner des blessures.

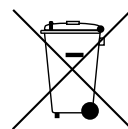

Le symbole "poubelle à roulettes" indique que ce produit ne peut pas être éliminé avec vos déchets ménagers en raison de la présence de substances dangereuses.

Afin de protéger votre santé et l'environnement, renseignez-vous auprès de vos autorités locales afin d'obtenir des conseils sur le recyclage et la localisation des installations adaptées (2012/19/EU, Europe uniquement).



K'nex

Building Basics Bases de Construction

Start Building

To begin your model, find the 1 and follow the numbers. Each piece has its own shape and color. Just look at the pictures, find the pieces in your set that match and then connect them together. Try to face your model in the same direction as the instructions while you build. The arrows show you where the parts connect, but not all connections points have arrows. Faded colors show you this section is already built.

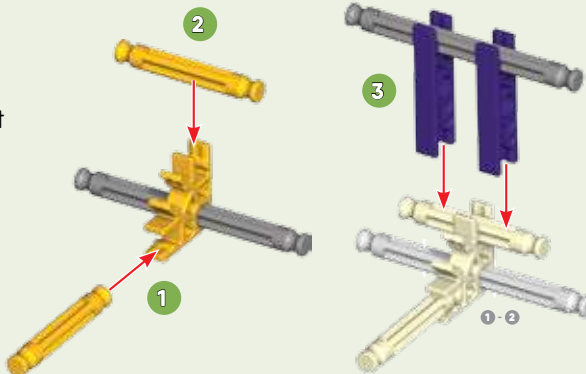

Démarre ta Construction

Pour commencer le modèle, cherche l'étape numéro 1 et suis les numéros dans l'ordre. Chaque pièce a sa propre forme et sa propre couleur. Regarde les illustrations, trouve les pièces qui y correspondent et les assemble-les. Pour te faciliter la tâche, oriente le modèle dans le même sens que les instructions. Les flèches indiquent où les pièces s'assemblent, mais les points de raccordement n'ont pas tous des flèches. Les pièces ayant une couleur estompée sont celles déjà assemblées.

Connectors

You can slide these special connectors together. Push tightly until you hear a "click". Pay close attention to the instructions and position them horizontally or vertically exactly as they are shown.

Connecteurs

Tu peux assembler ces connecteurs spéciaux en les faisant glisser l'un dans l'autre. Pousse fort jusqu'à entendre un « clic ». Lis attentivement les instructions et positionne-les horizontalement ou verticalement, en suivant exactement les illustrations.

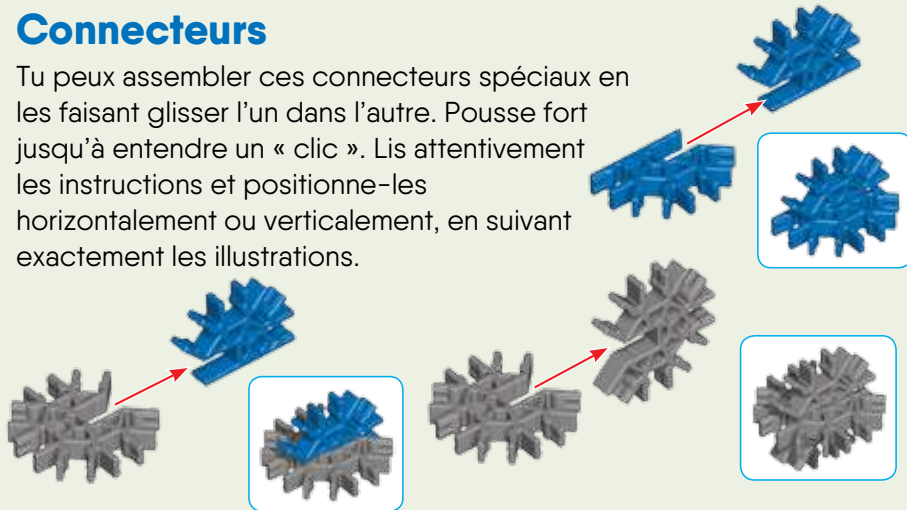

Spacers

There are places in your model where you need to add spacers. Be sure to use the correct number of spacers shown in the instructions.

Séparateurs

Il y a des endroits sur le modèle où des séparateurs sont nécessaires. Assure-toi d'utiliser la bonne nombre de séparateurs, comme indiqué sur les instructions.



Chain

Be sure to attach all the chain links in the same direction.



Chaîne

Assure-toi de fixer tous les maillons de la chaîne dans le même sens.

Parts List

Before you start building, be sure to compare the parts in your set with the parts list here. If anything is missing, call or write to us using the information on the back cover. We are here to help you!

Liste des Pièces

Avant de commencer à construire, assure-toi de comparer les pièces dans ta boîte à la liste de pièces fournie ici. S'il manque quelque chose, téléphone-nous ou écris-nous en te servant des informations figurant au verso de la notice. Nous sommes là pour t'aider !

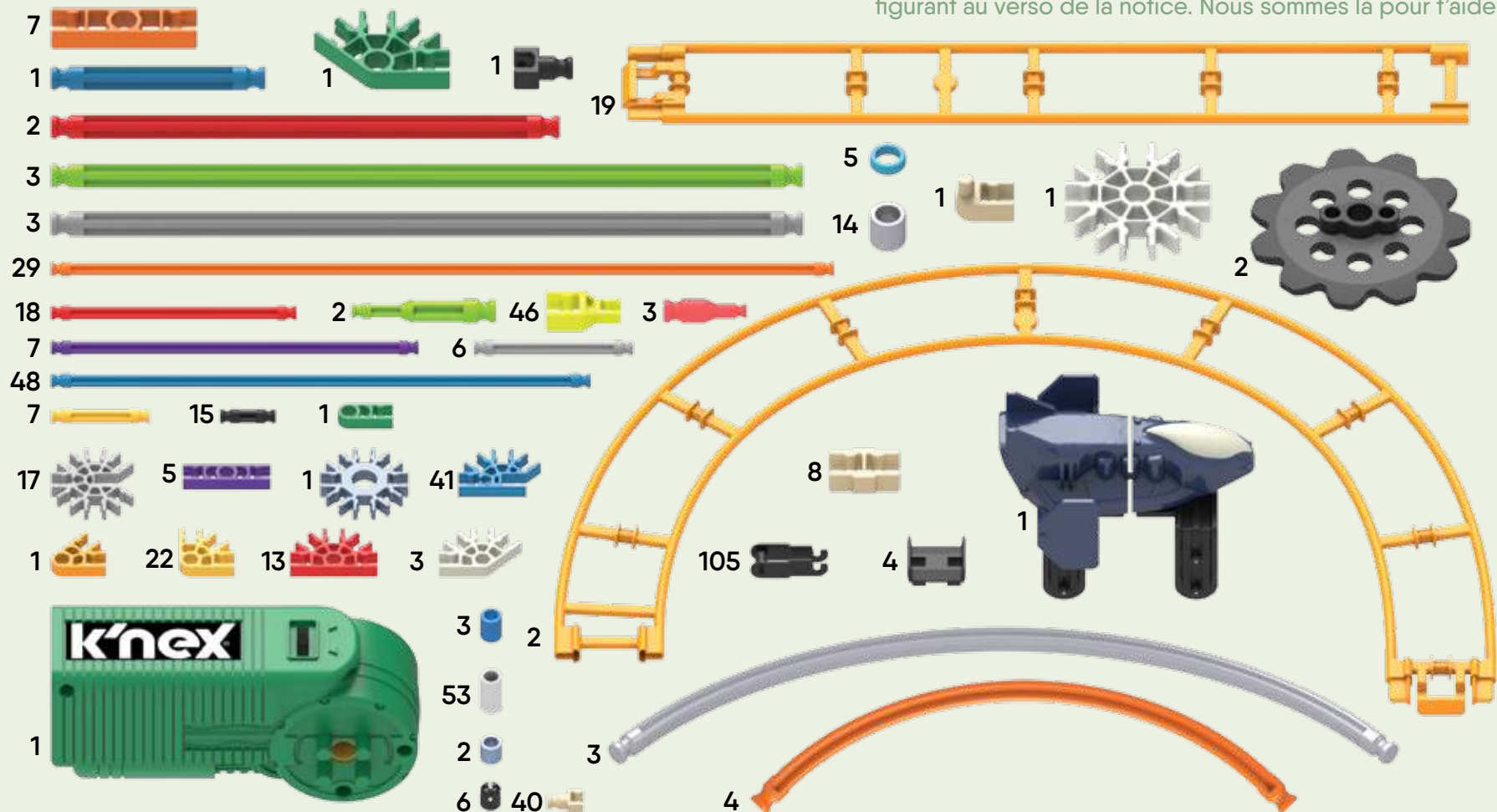

TIP: While you're building make sure you face your model in the same direction as the pictures show in the instructions.

CONSEIL : Essaie de situer ton modèle dans le même sens que les instructions durant le montage.

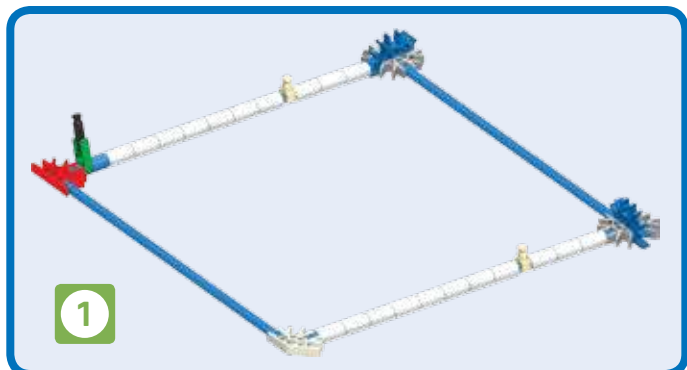
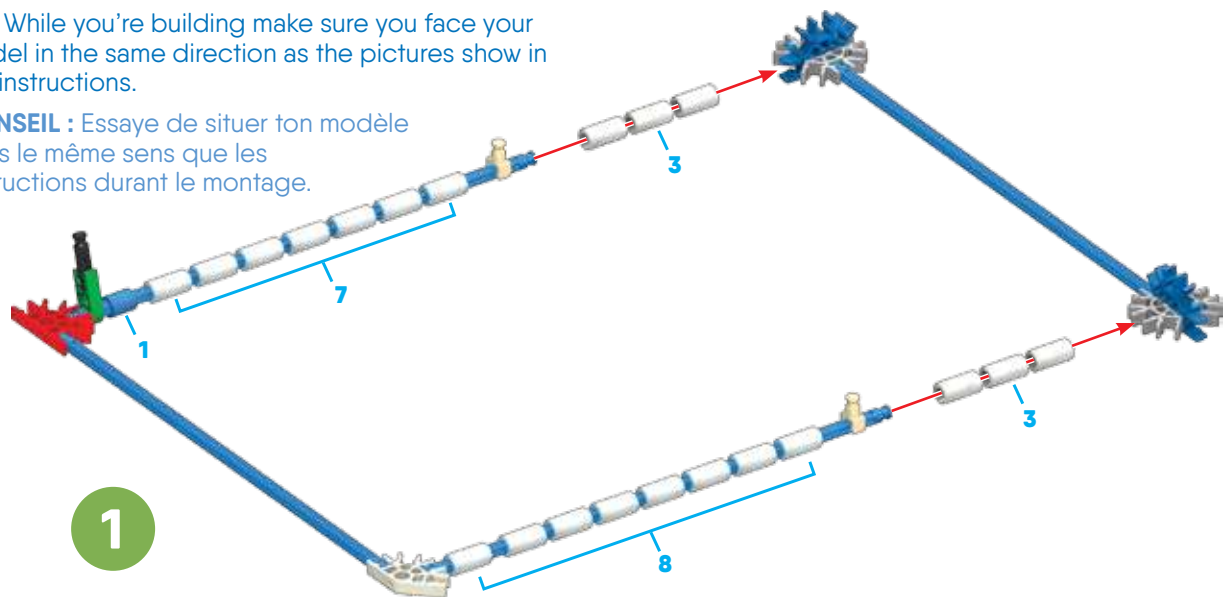

- | | | | | | |
|---|----|---|---|---|---|
| 1 | 21 | 1 | 2 | 2 | 1 |
| 1 | 1 | 1 | 2 | 1 | 1 |
| 4 | | | | | |

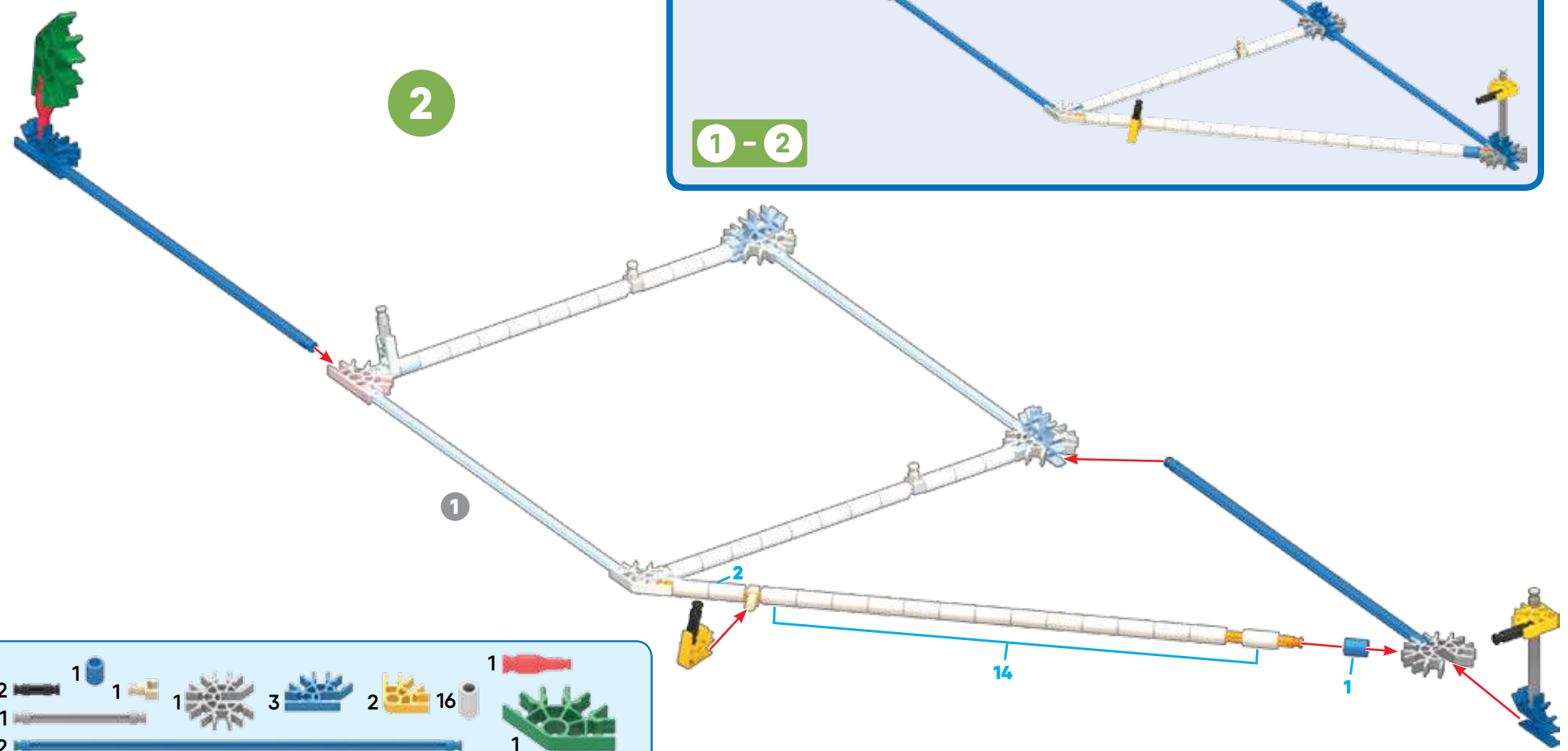
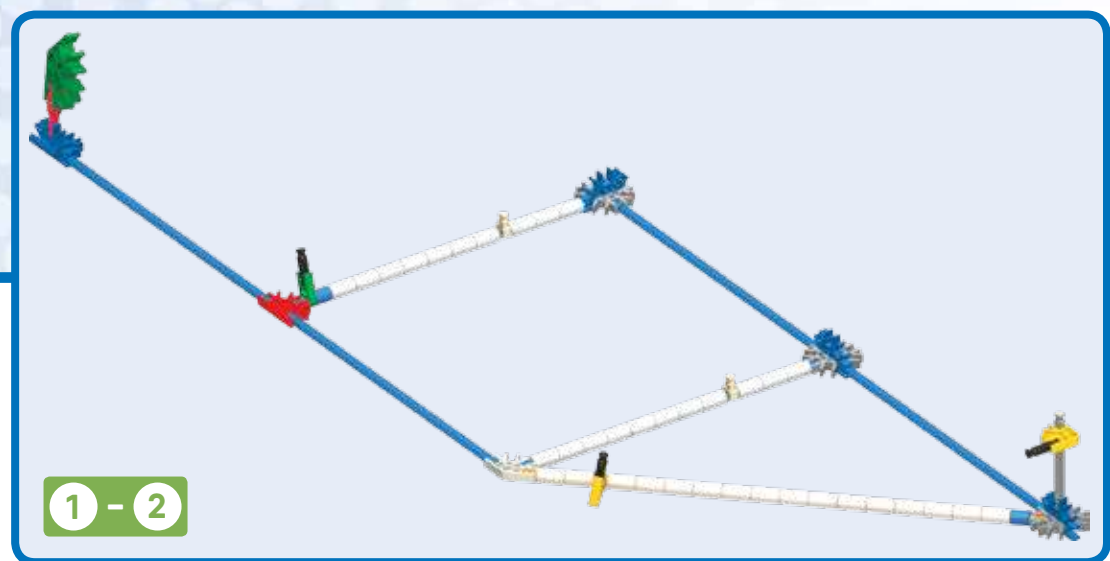

- | | | | | | | | |
|---|---|---|---|---|---|----|---|
| 2 | 1 | 1 | 1 | 3 | 2 | 16 | 1 |
| 1 | | | 1 | | | | 1 |
| 2 | | | | | | | |
| 1 | | | | | | | |

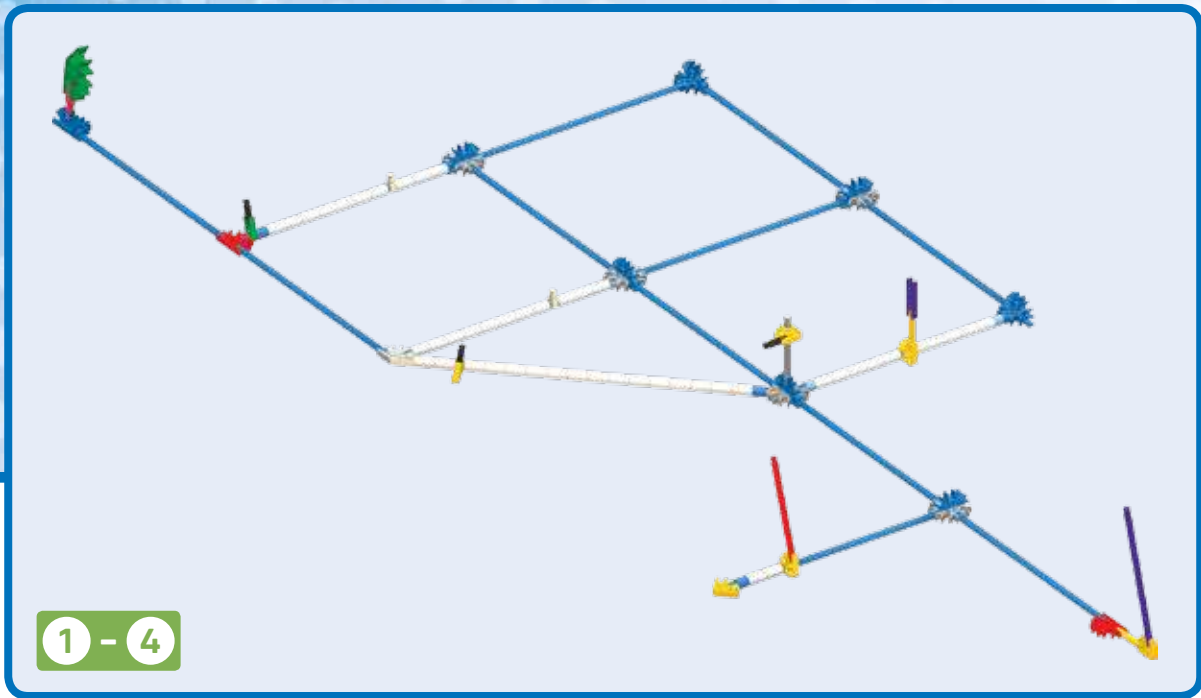

4

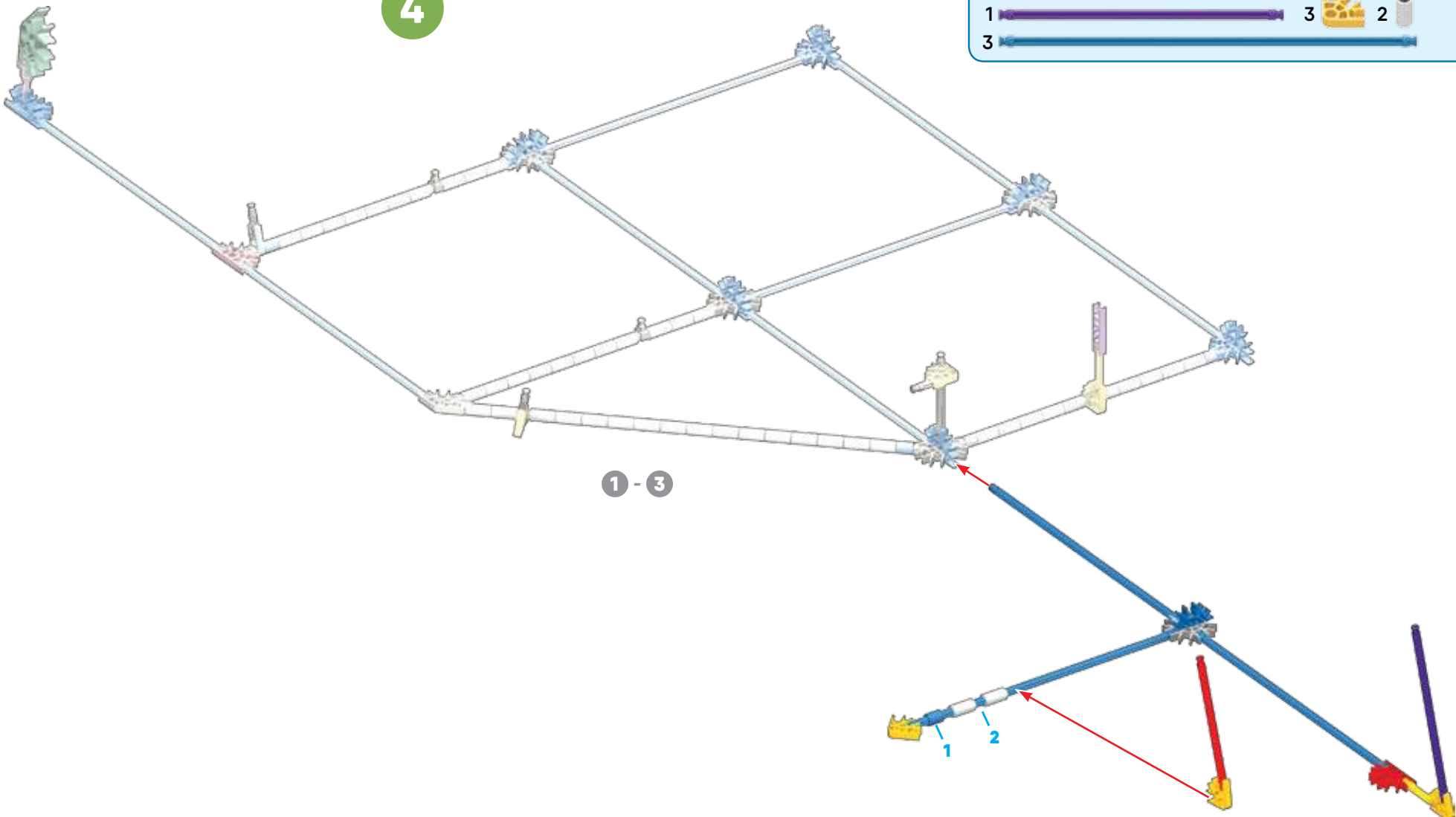
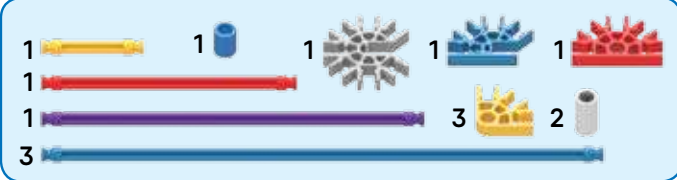

1 - 3

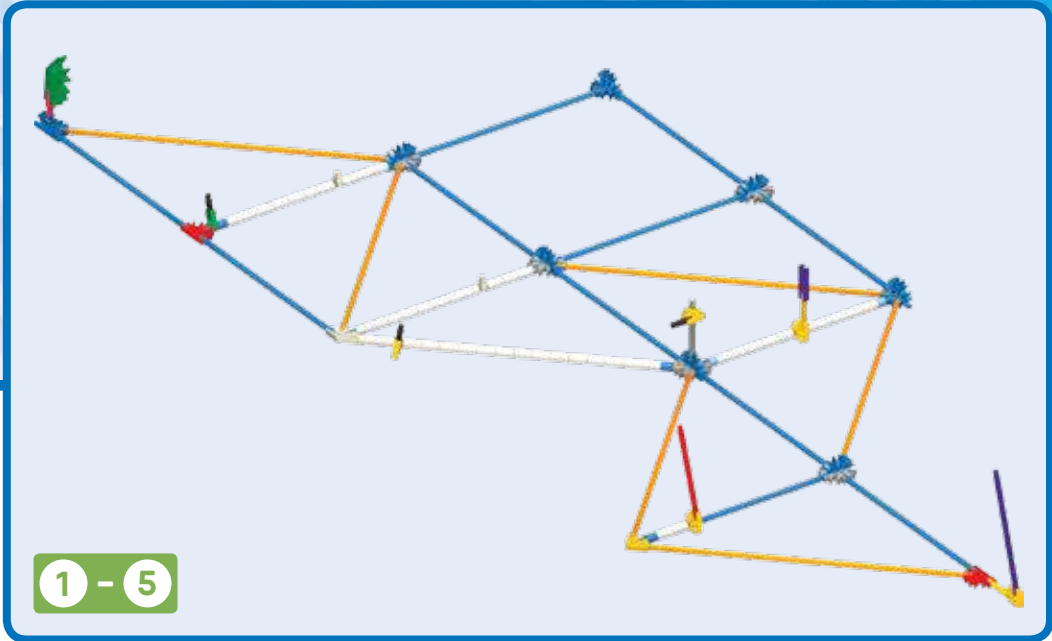

5

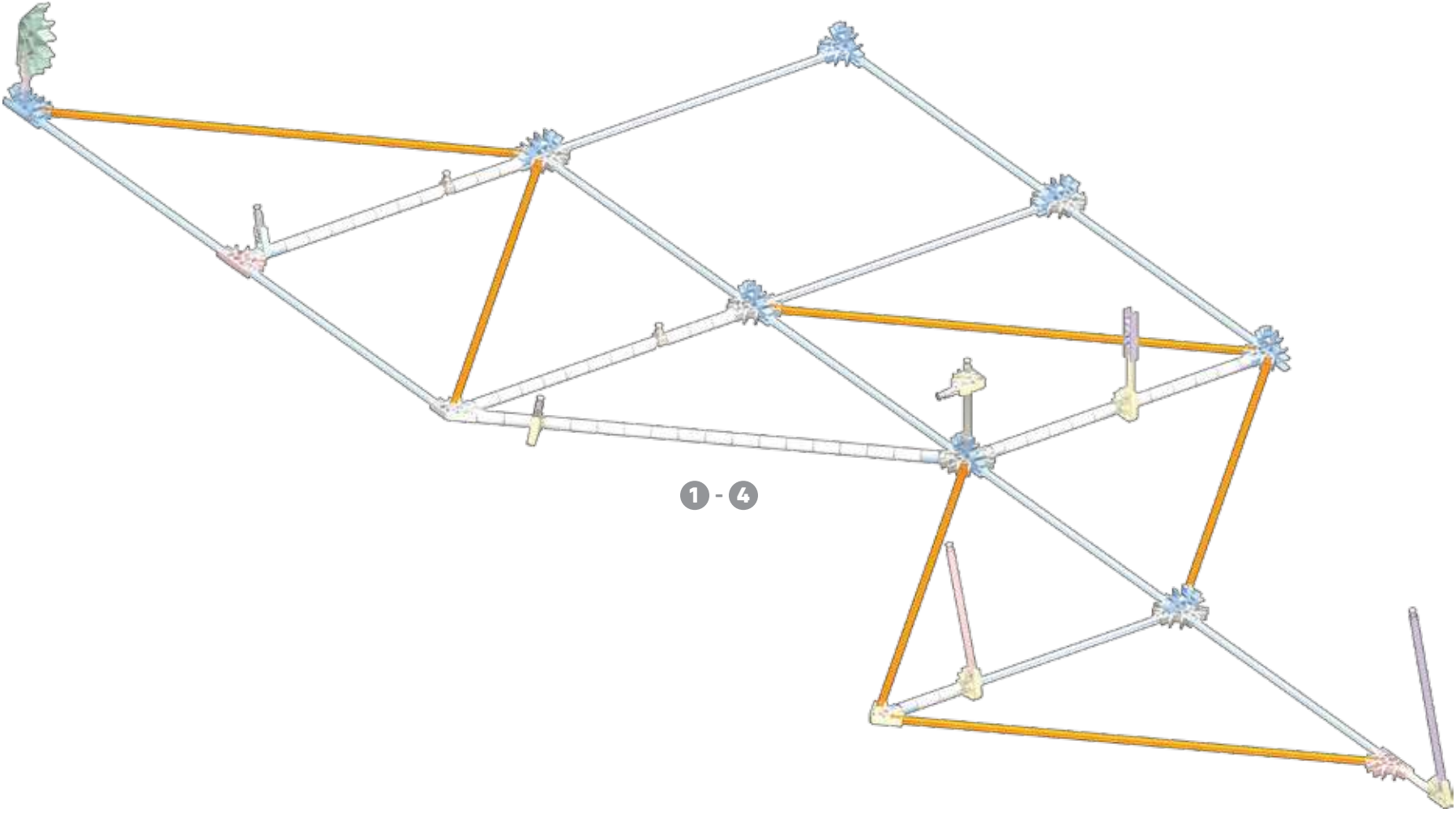

1 - 4

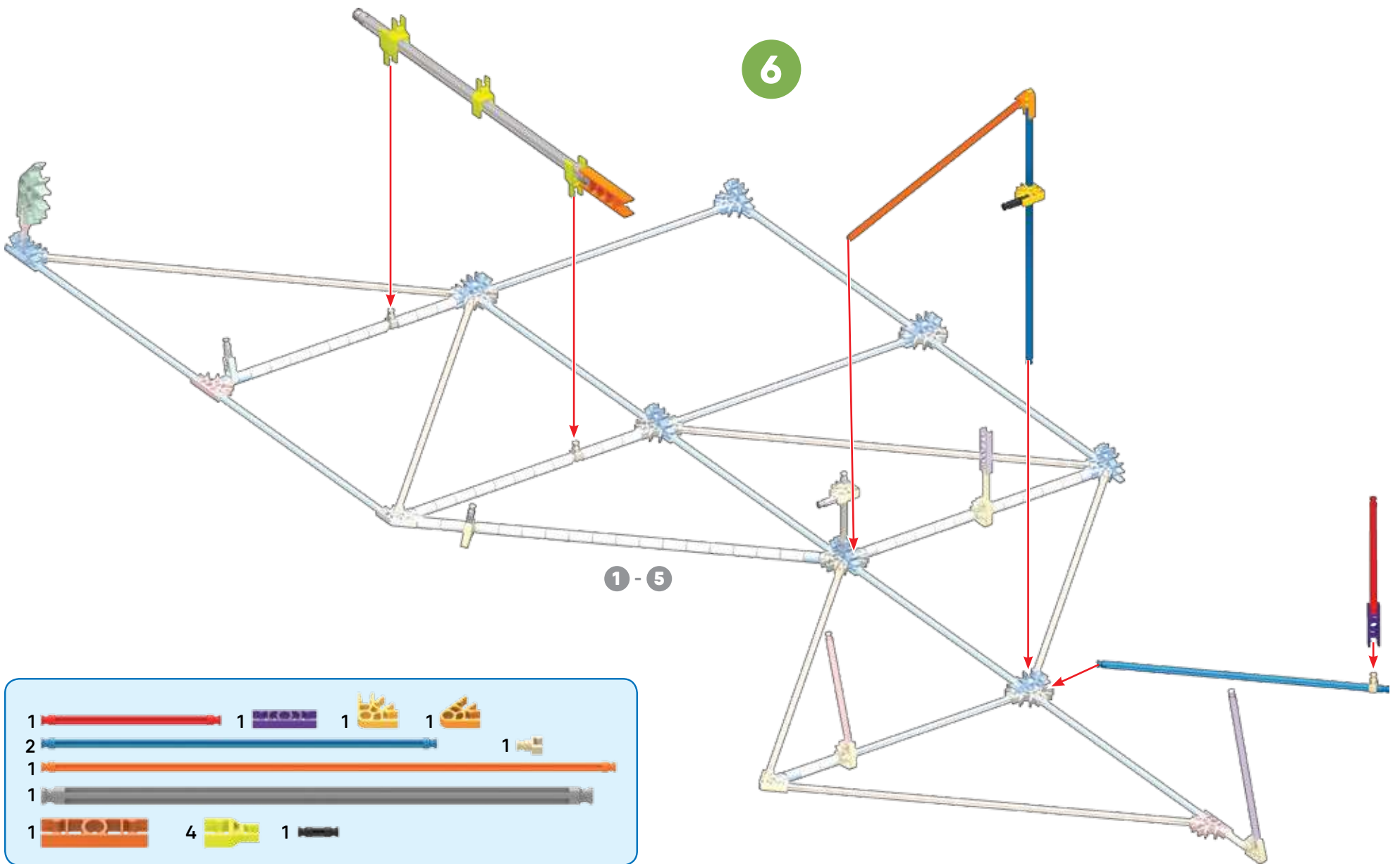

- 1  1  1  1 
- 2  1 
- 1 
- 1 
- 1  4  1 

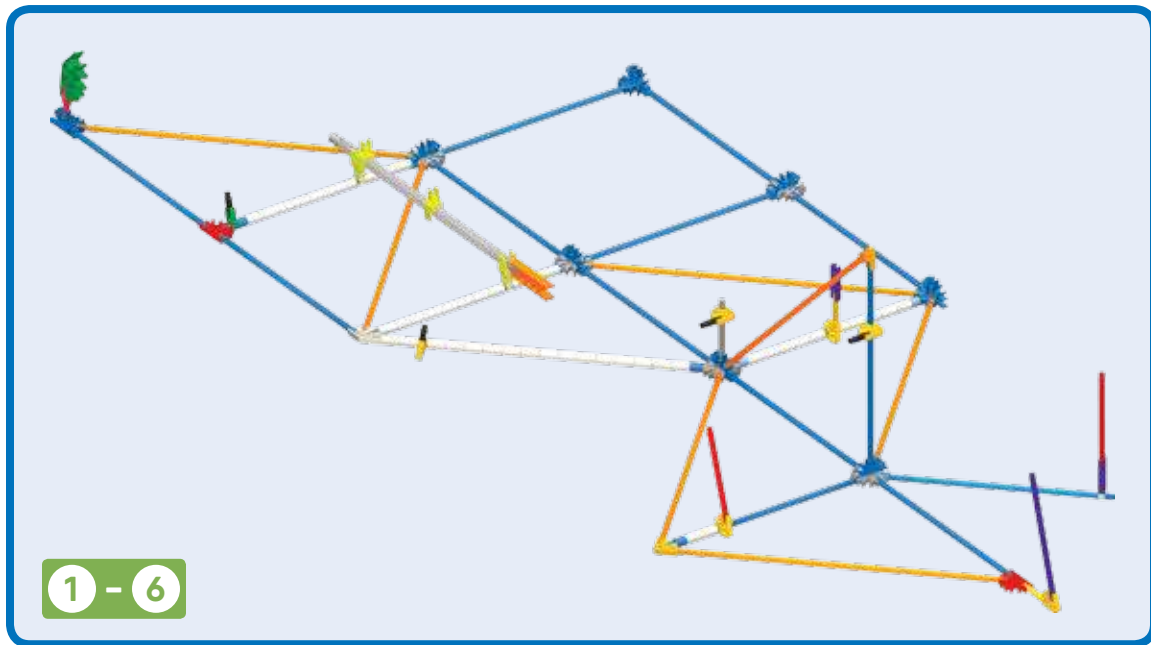

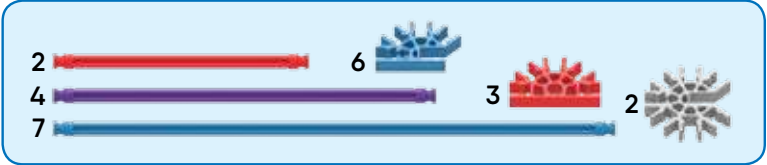
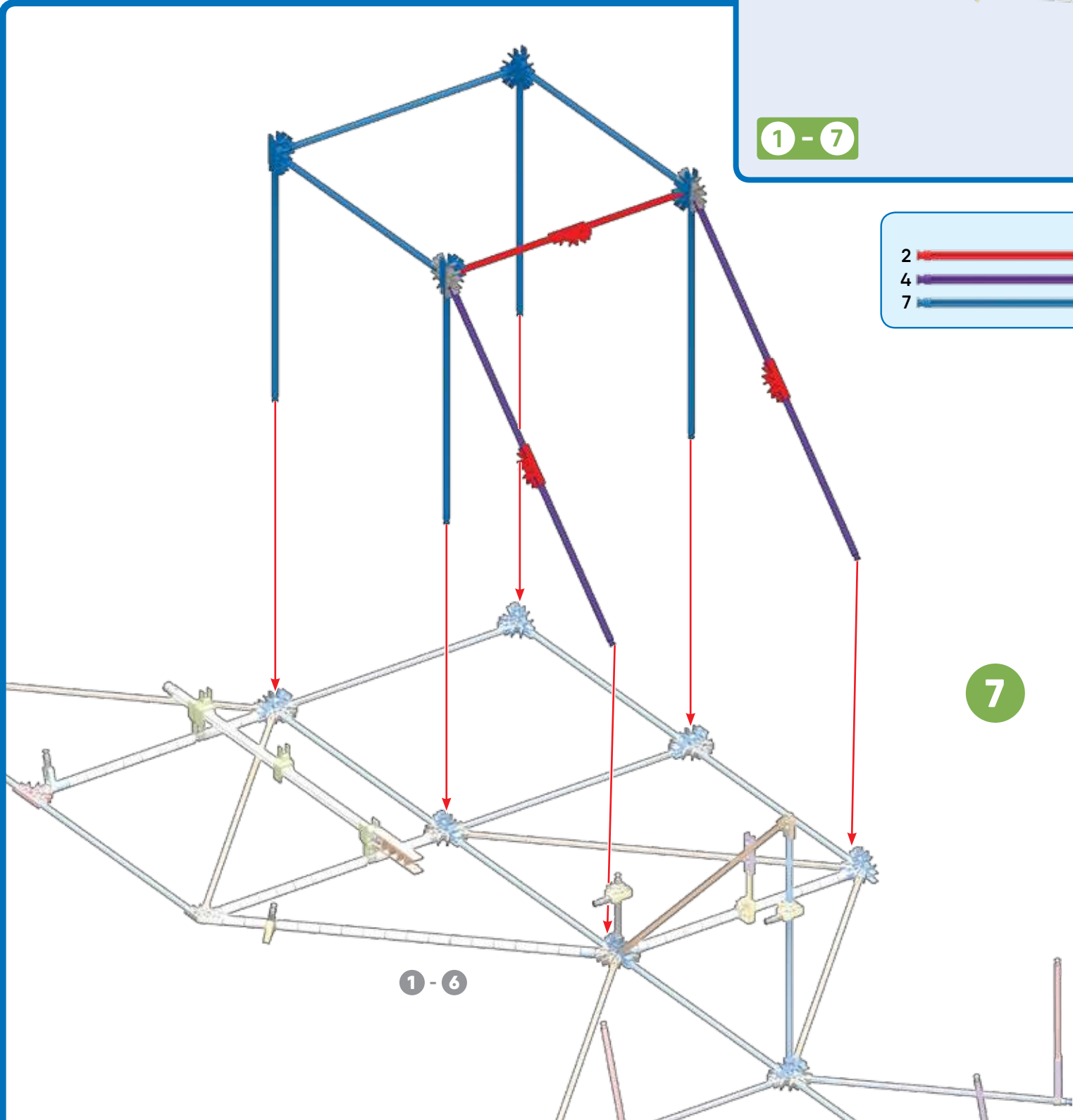
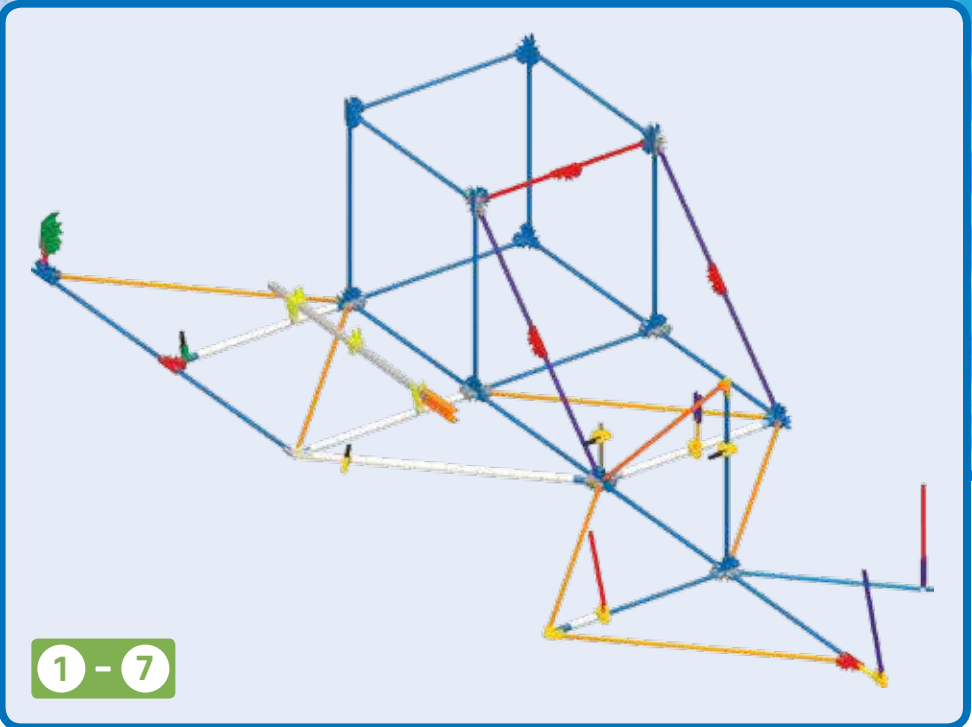

8

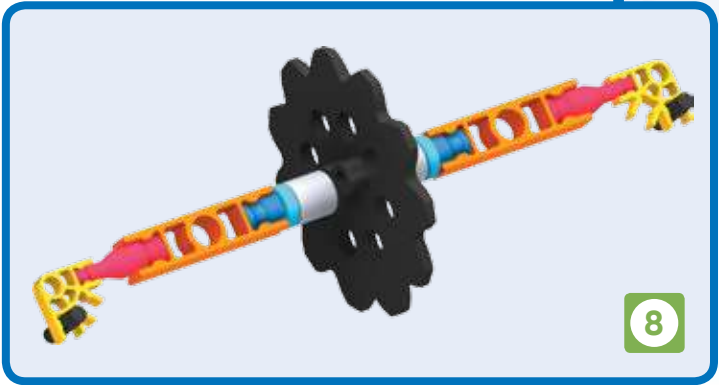
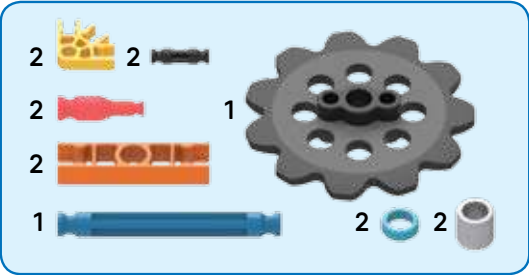
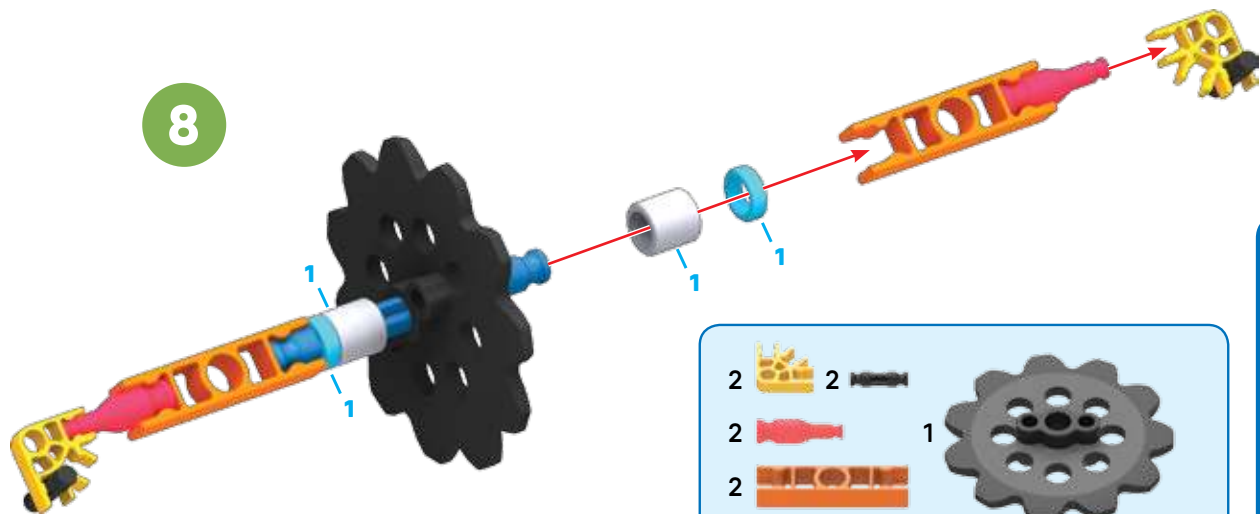

8

9

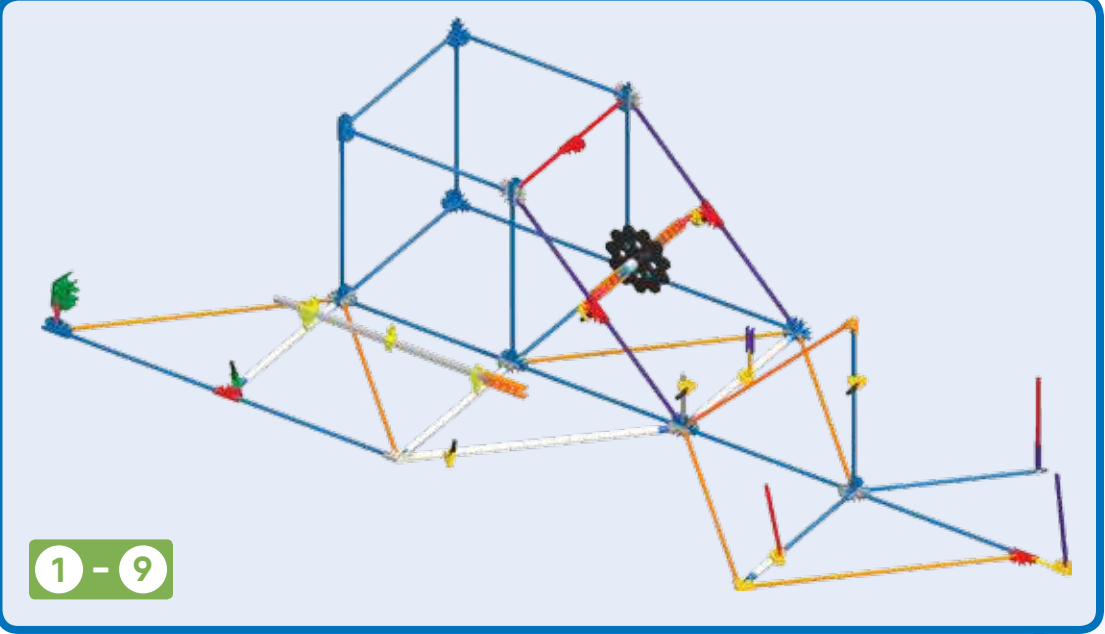
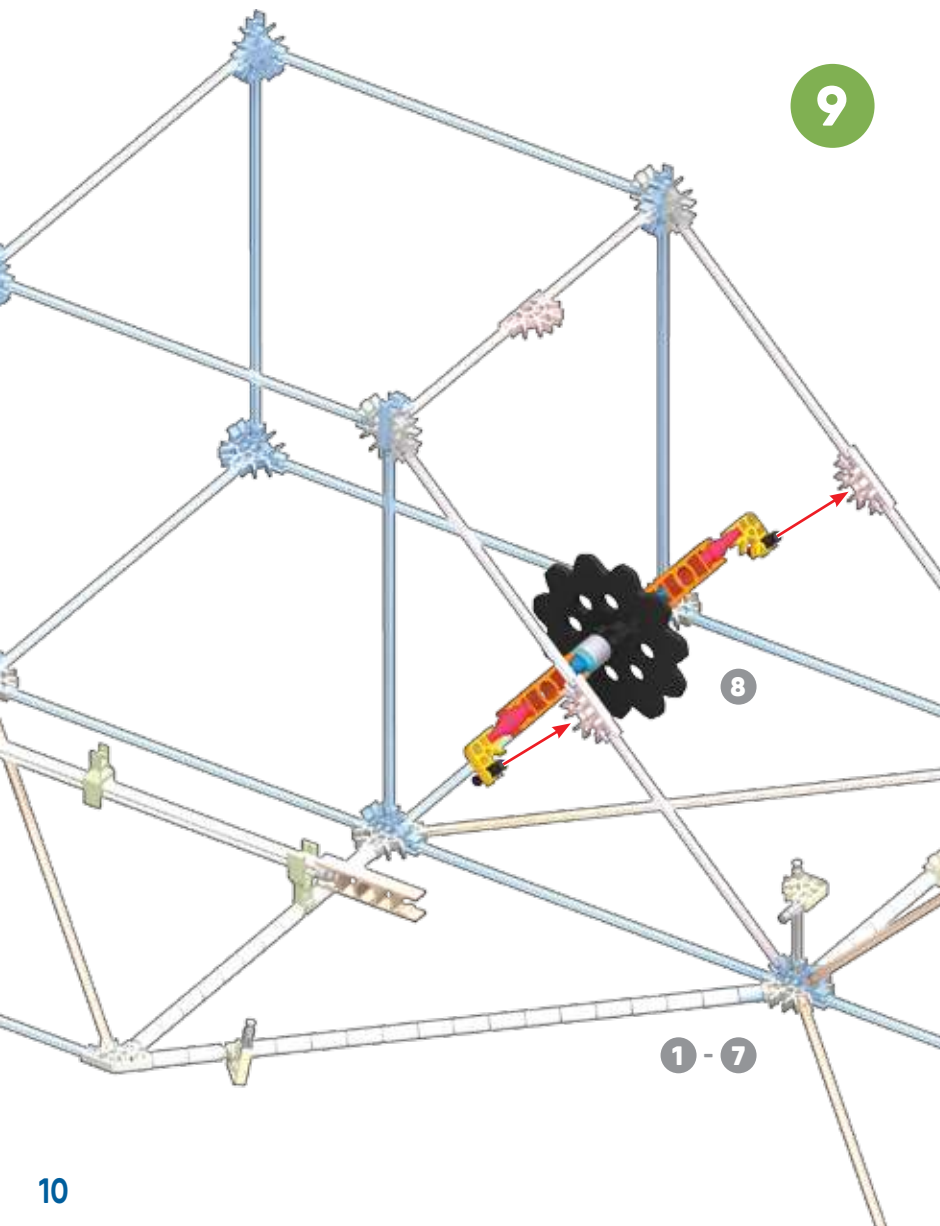

1 - 9

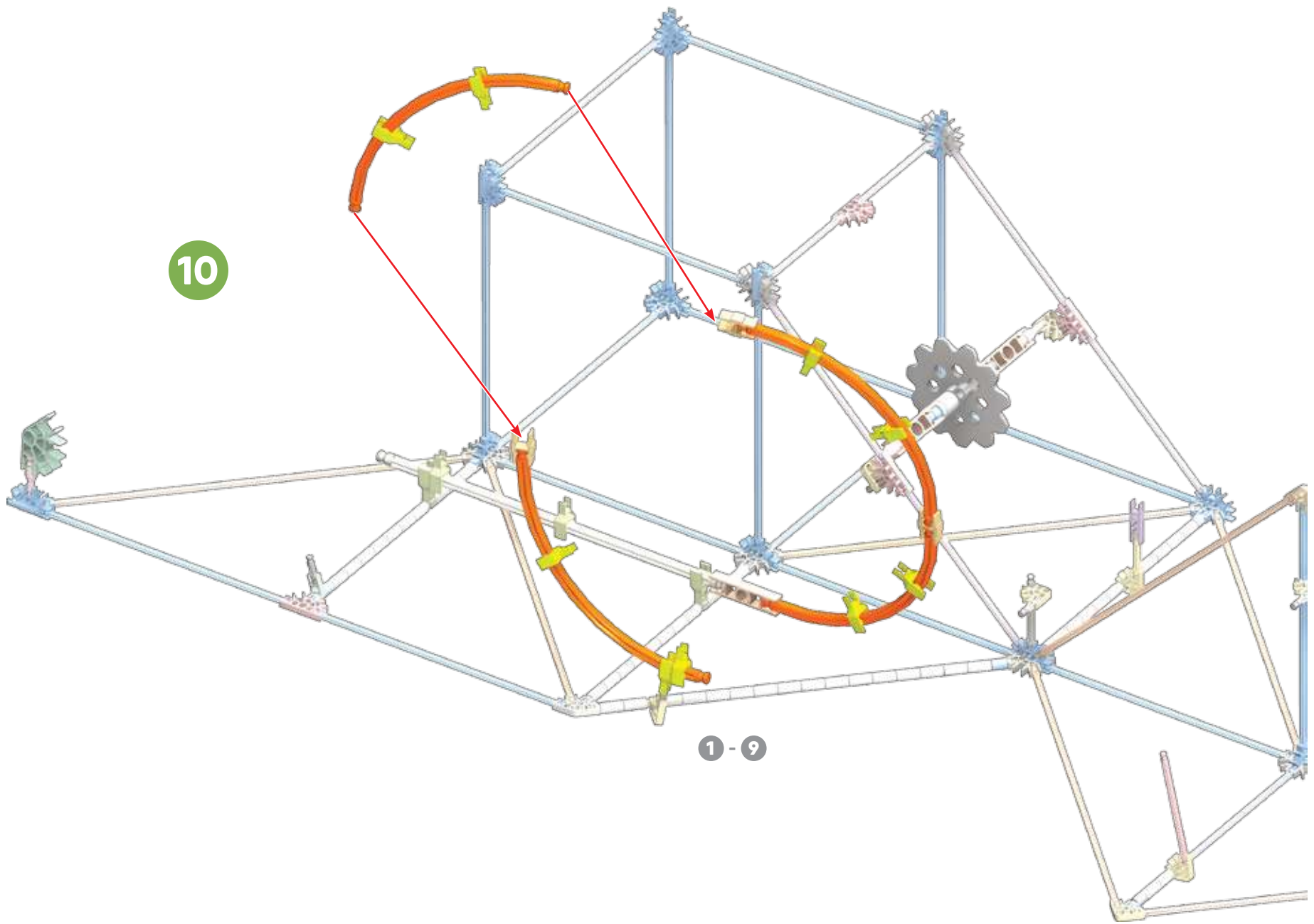
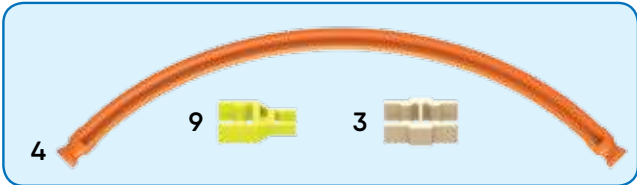
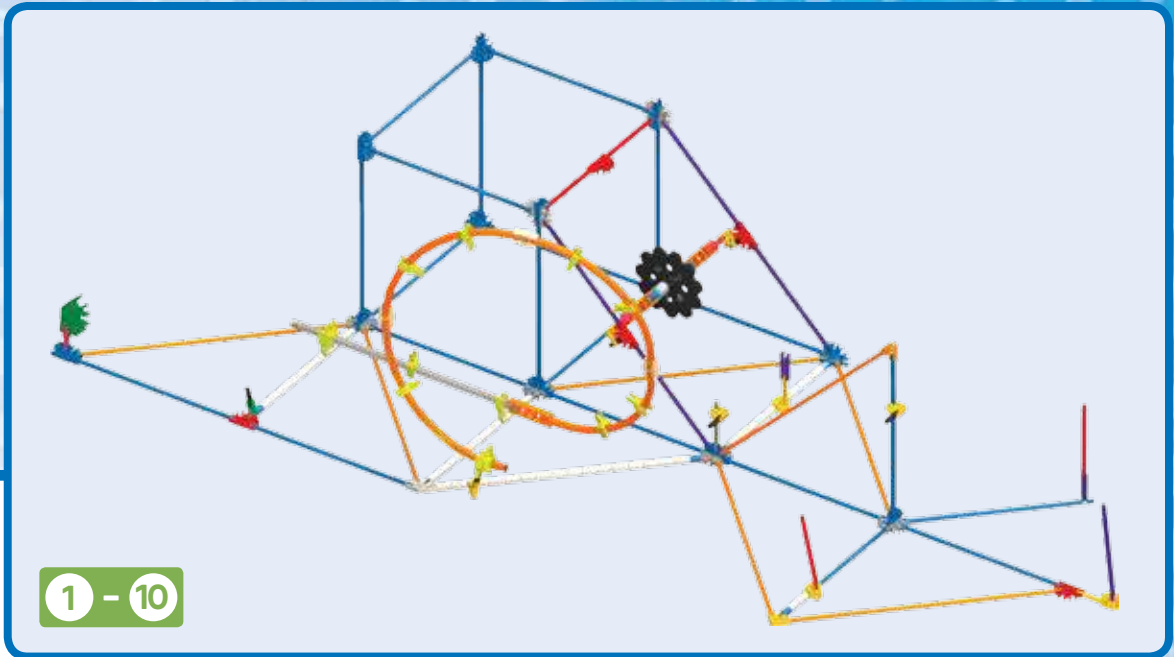

11

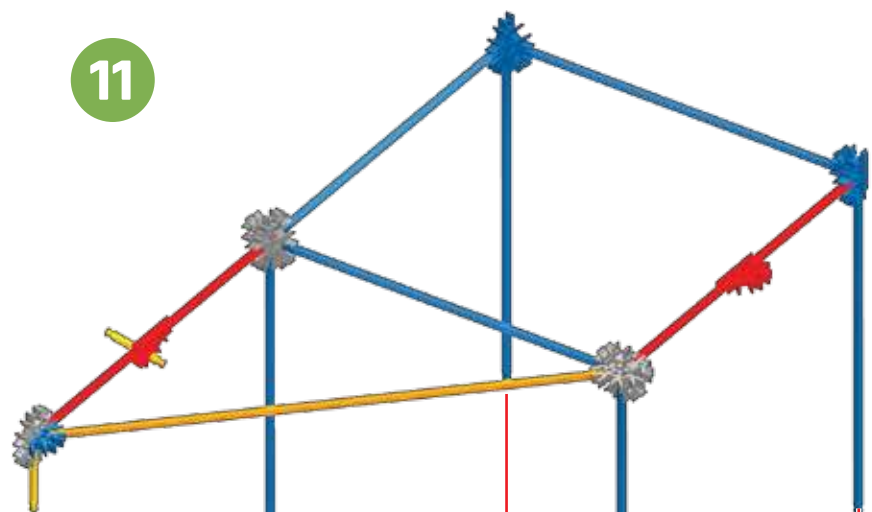

1 - 11

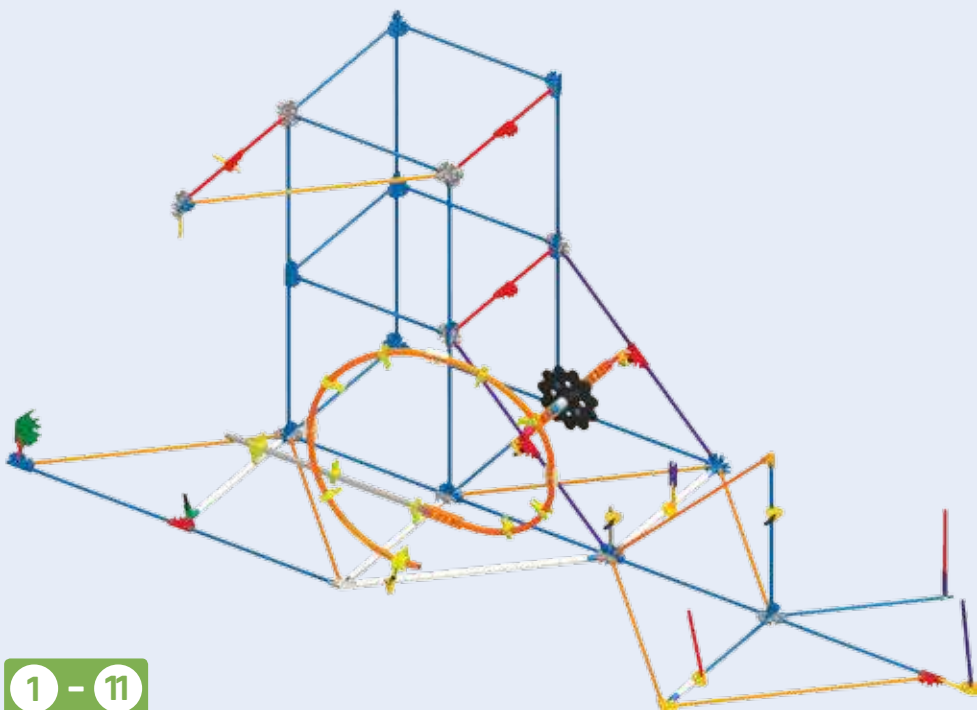

2

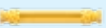

4



2



5



5



7



1



1 - 10

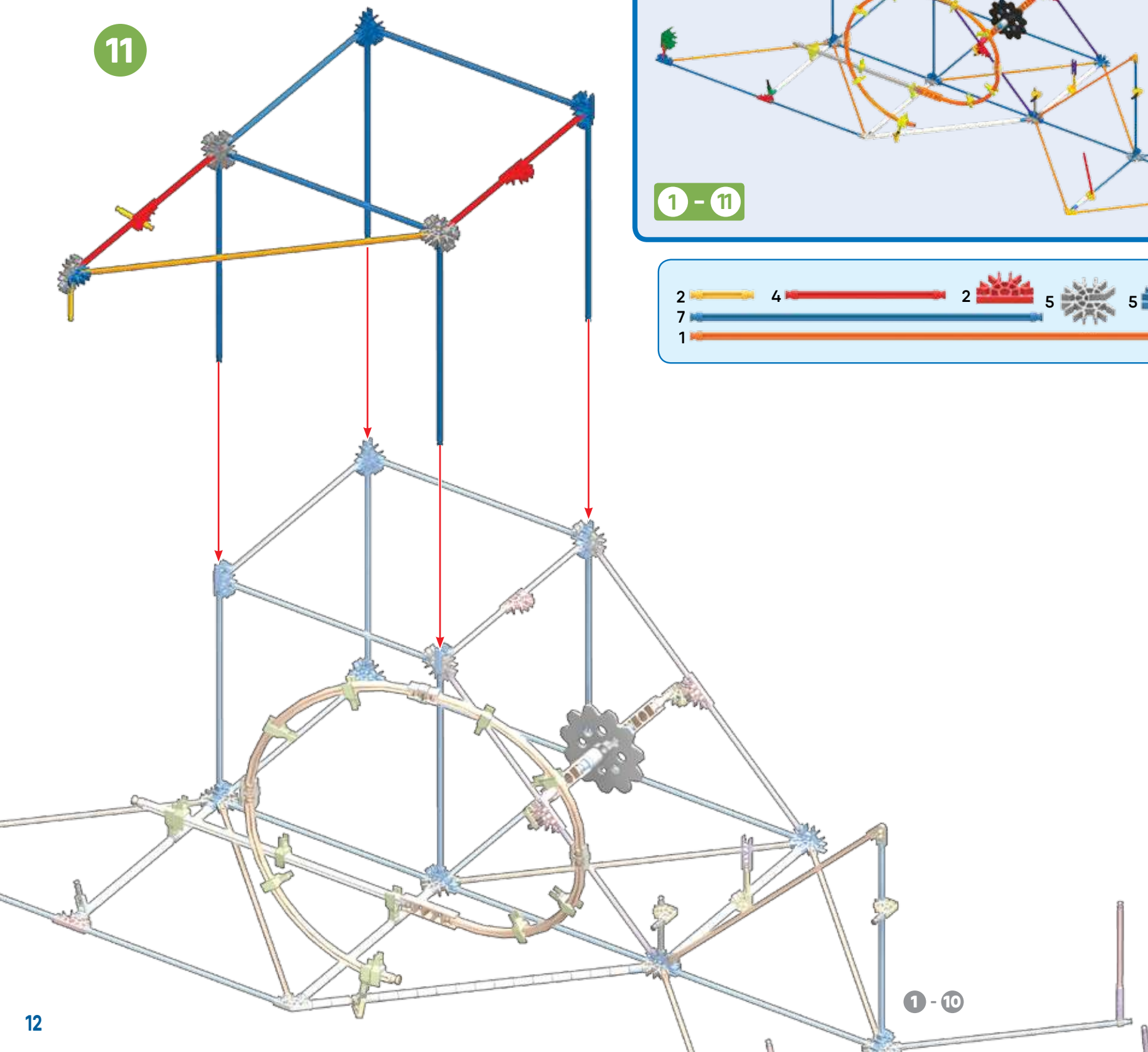

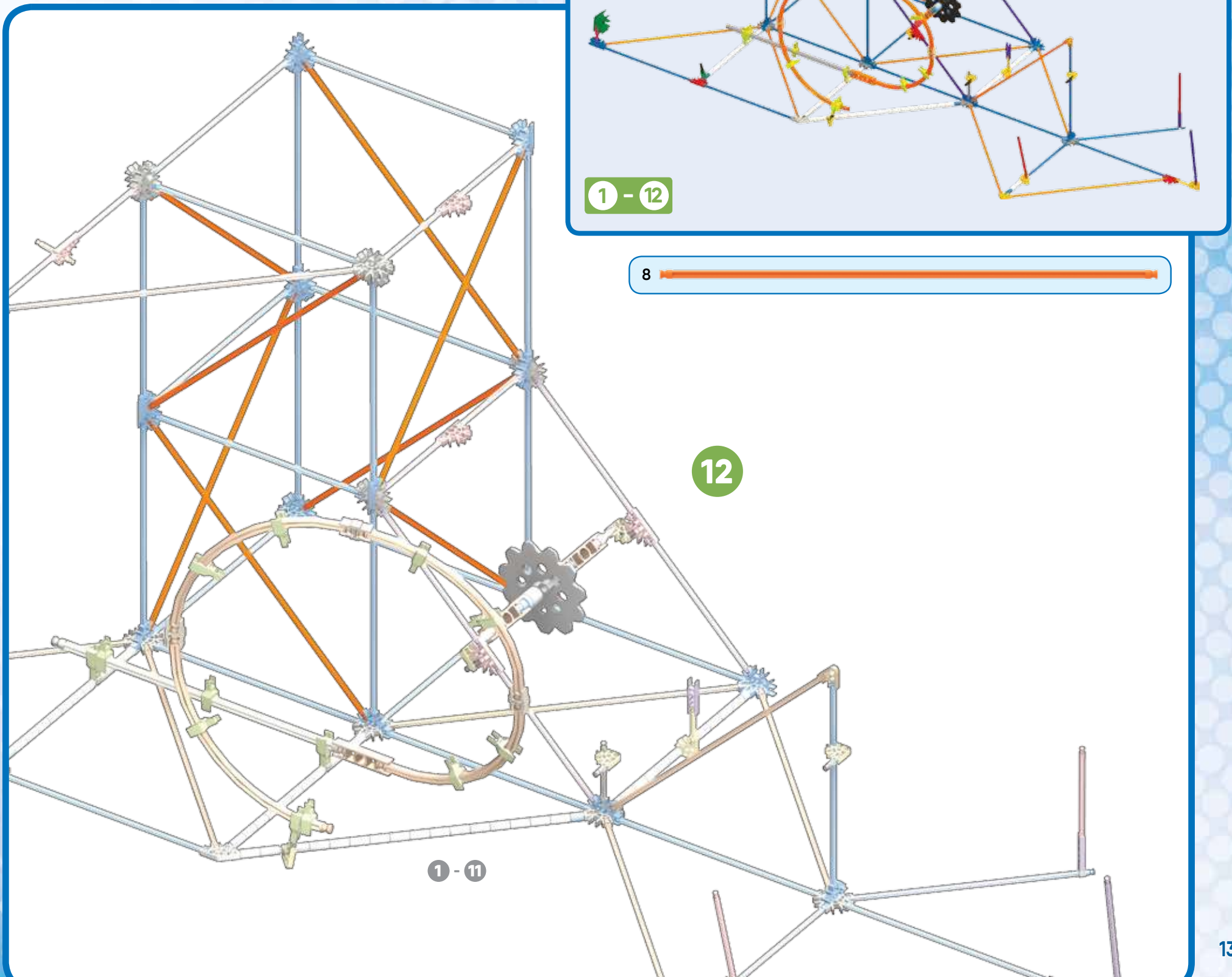

1 - 12

8

12

1 - 11

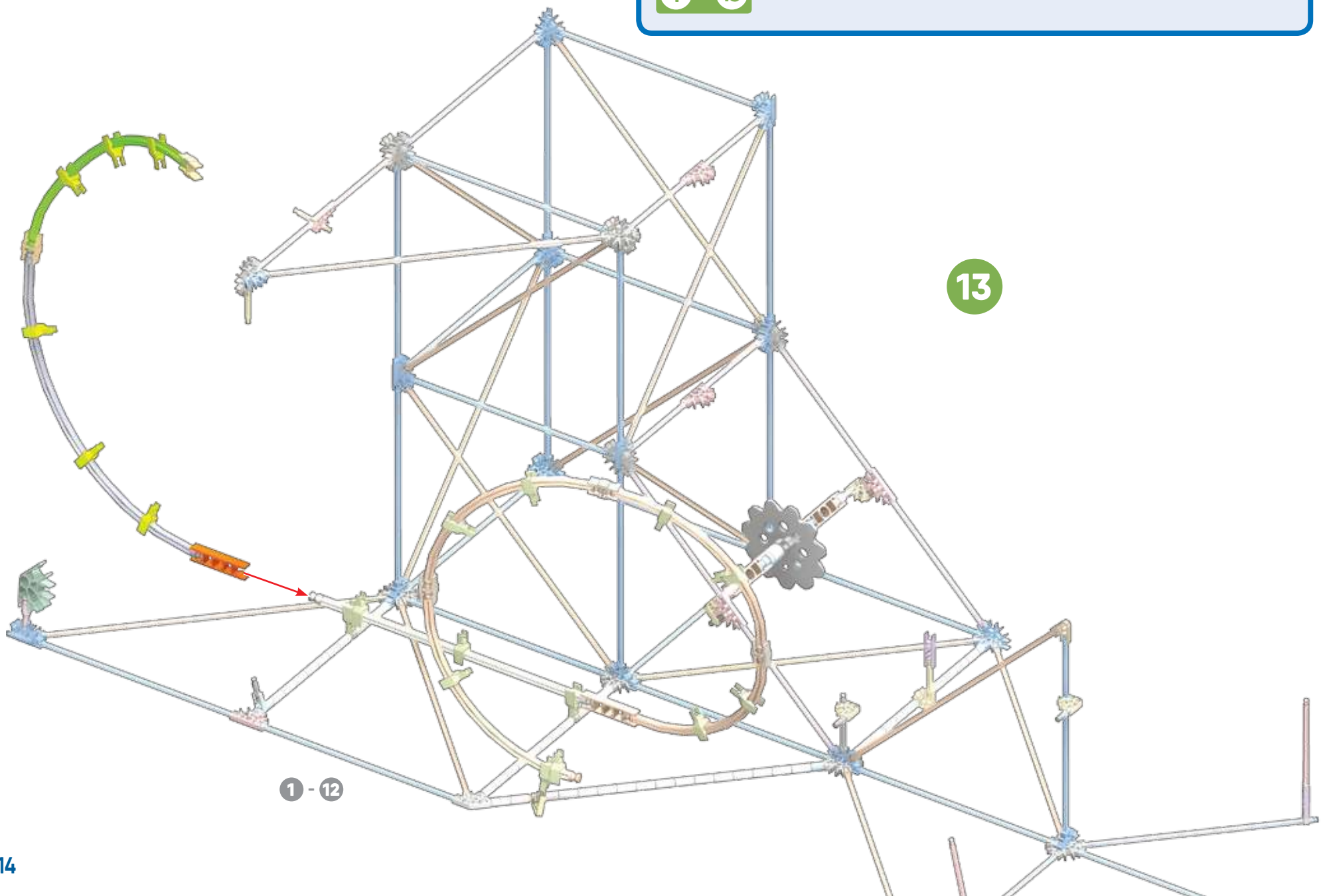
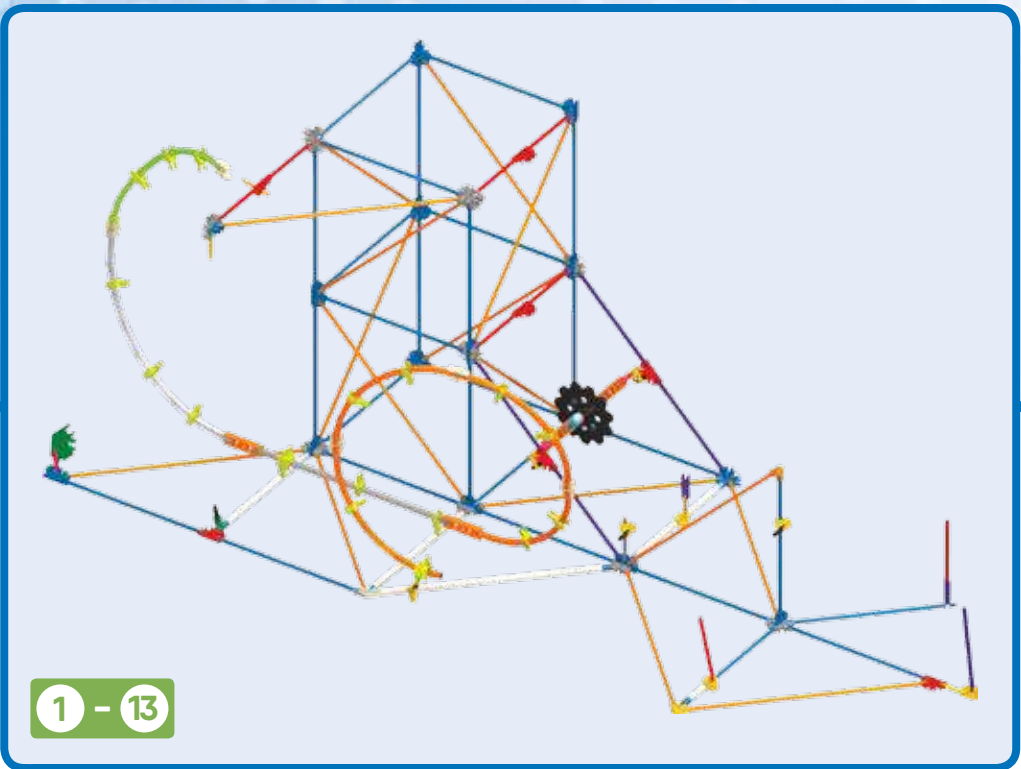
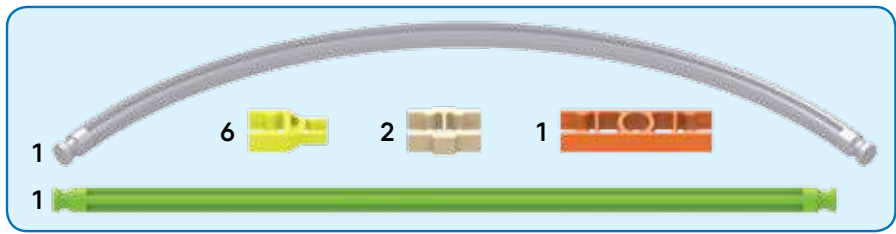

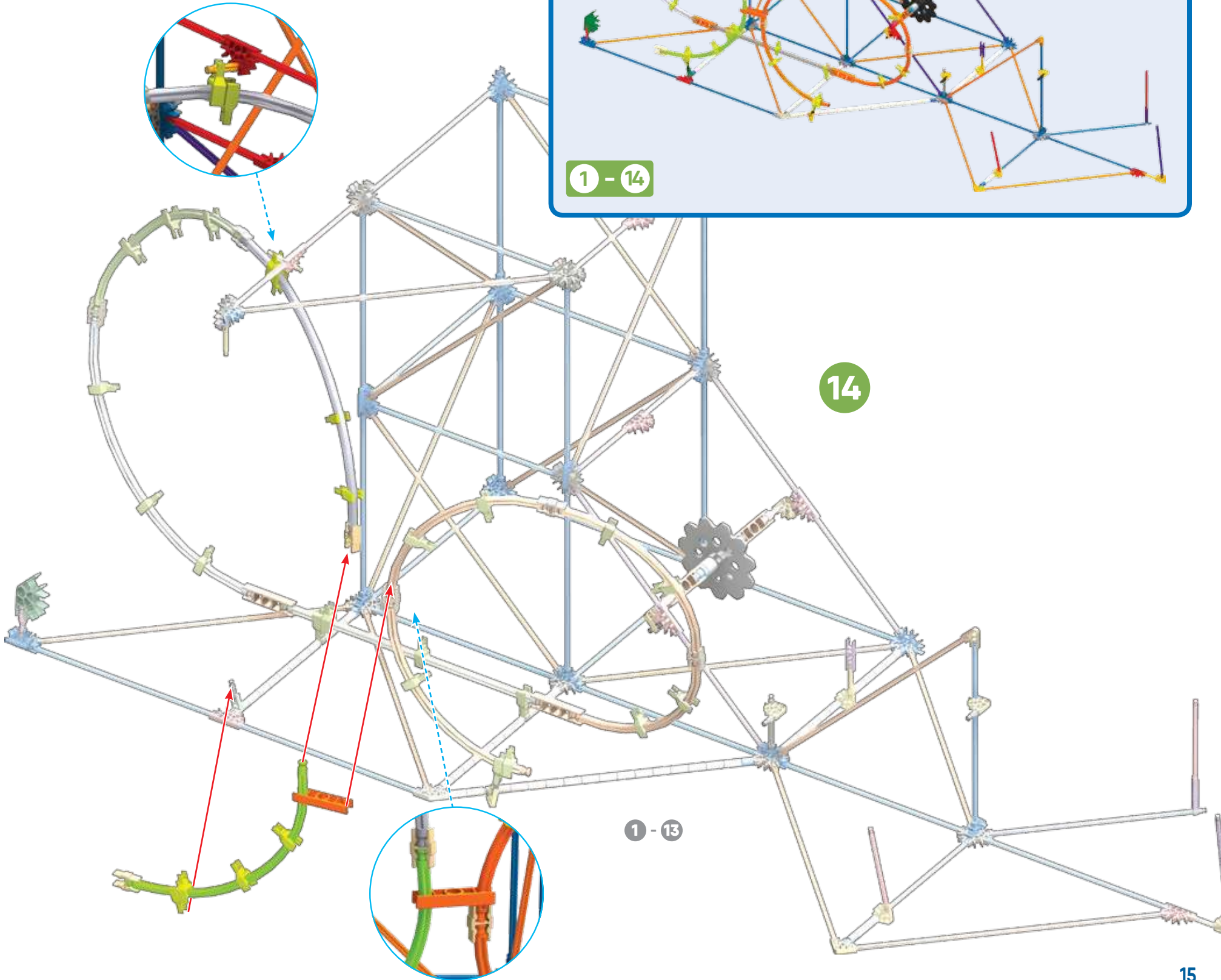
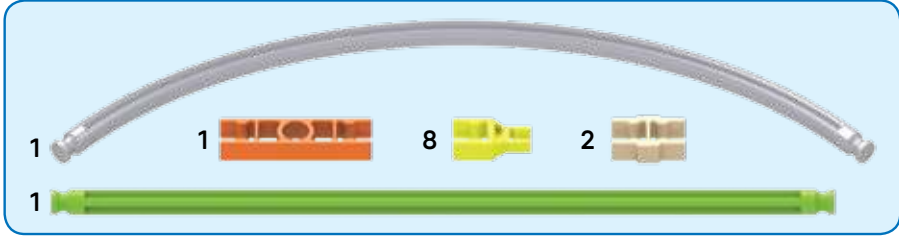
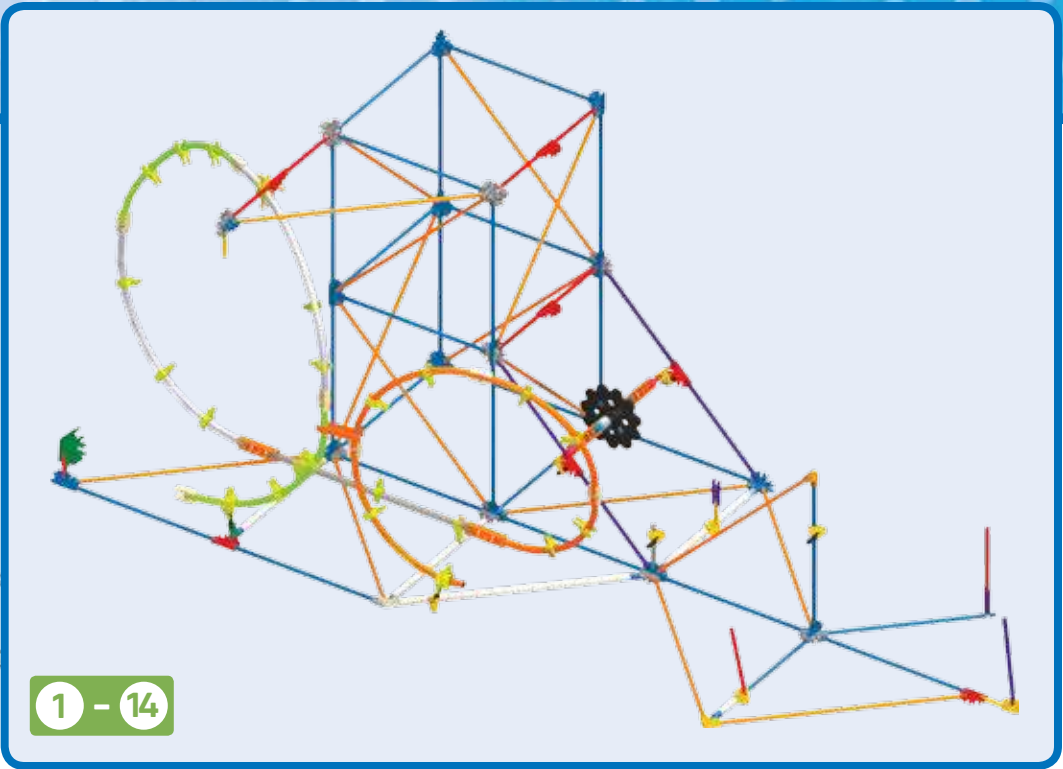

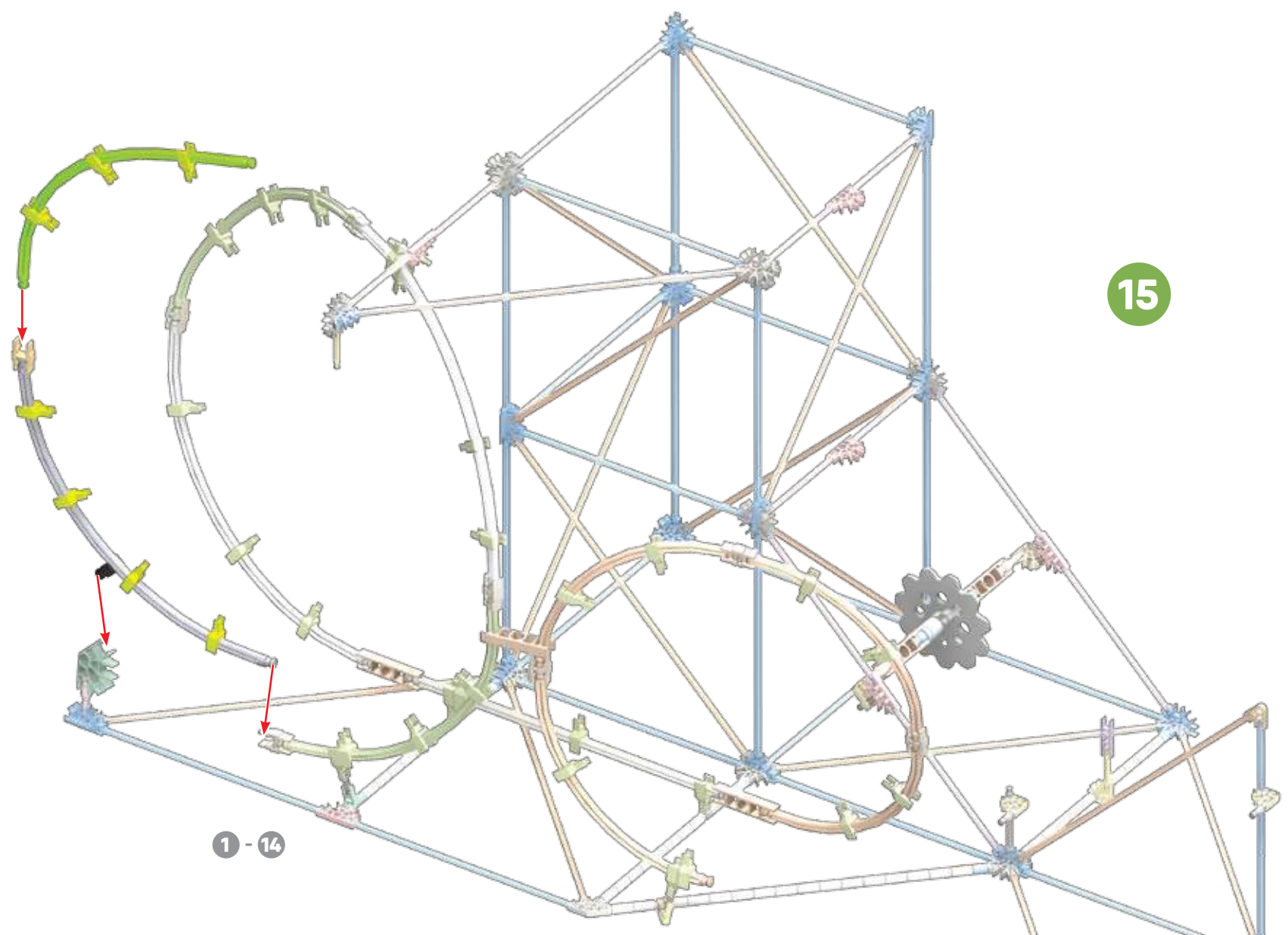
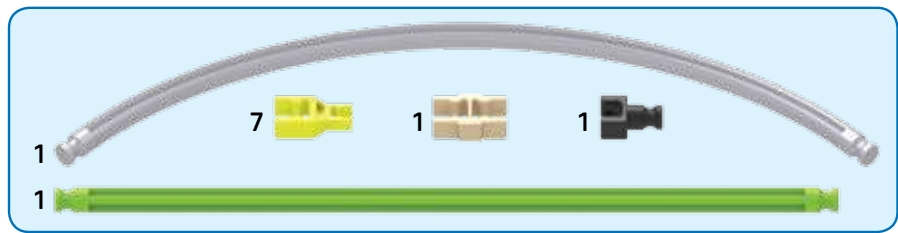
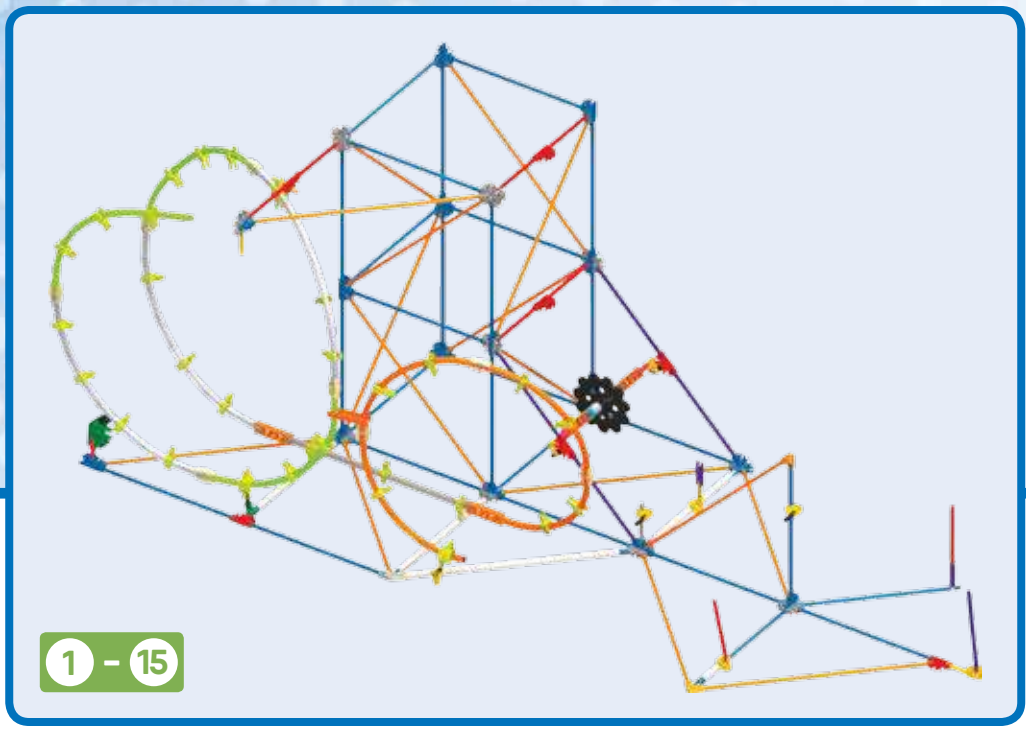

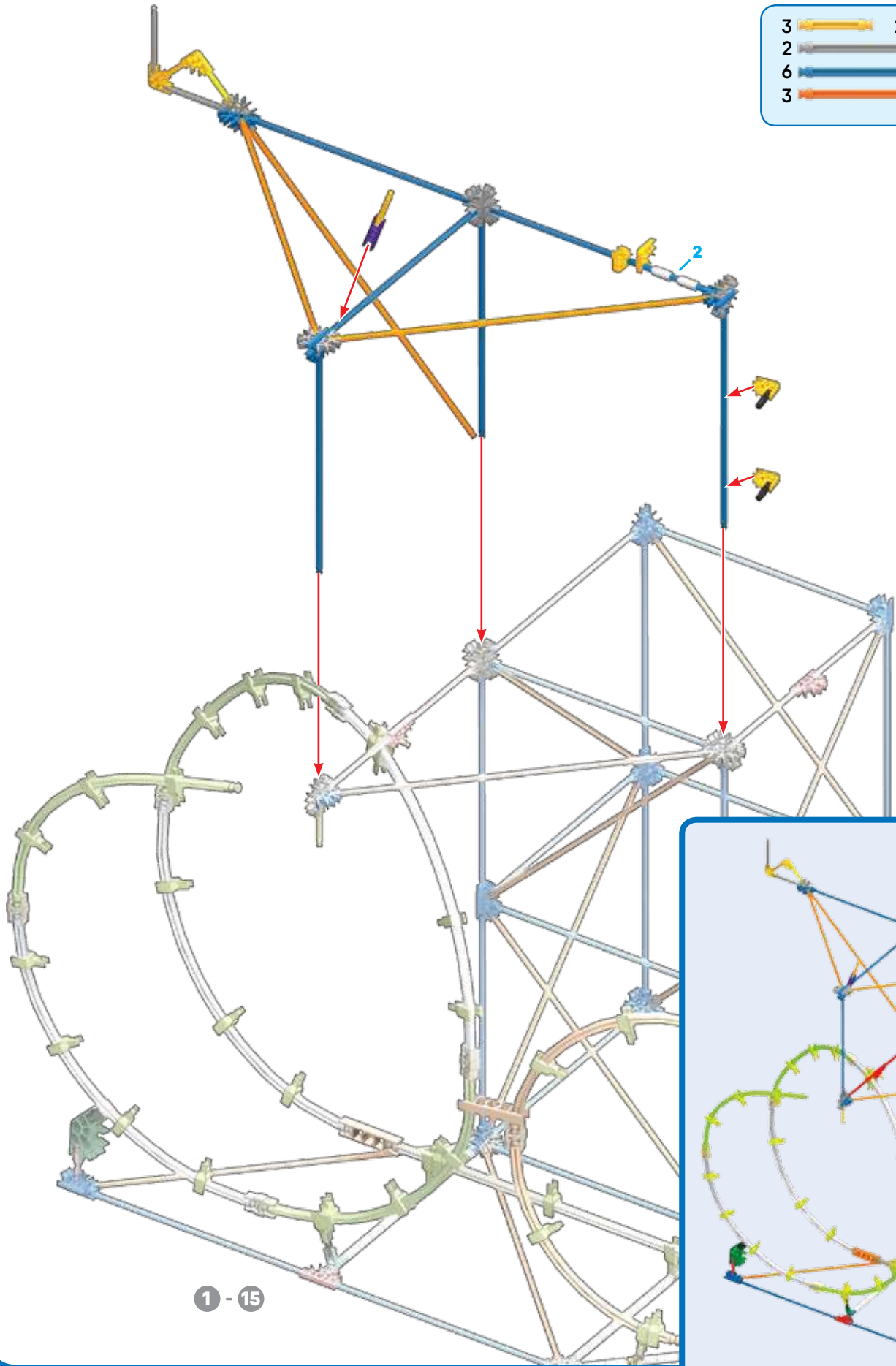
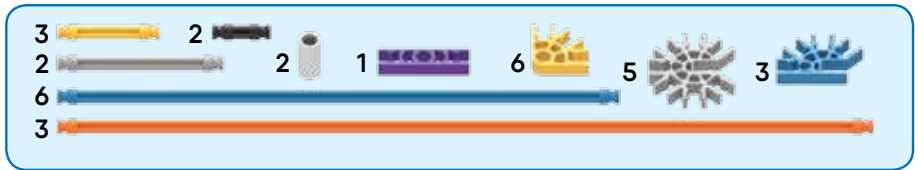

16

1 - 15

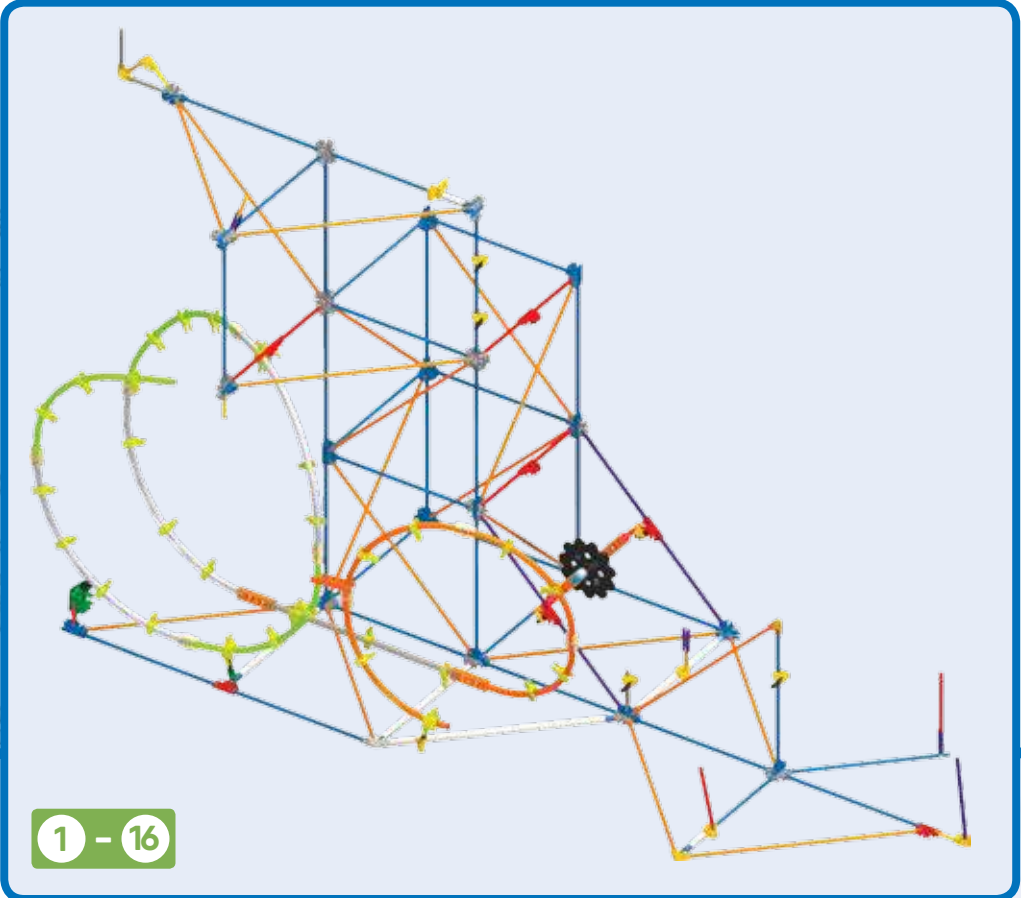

1 - 16

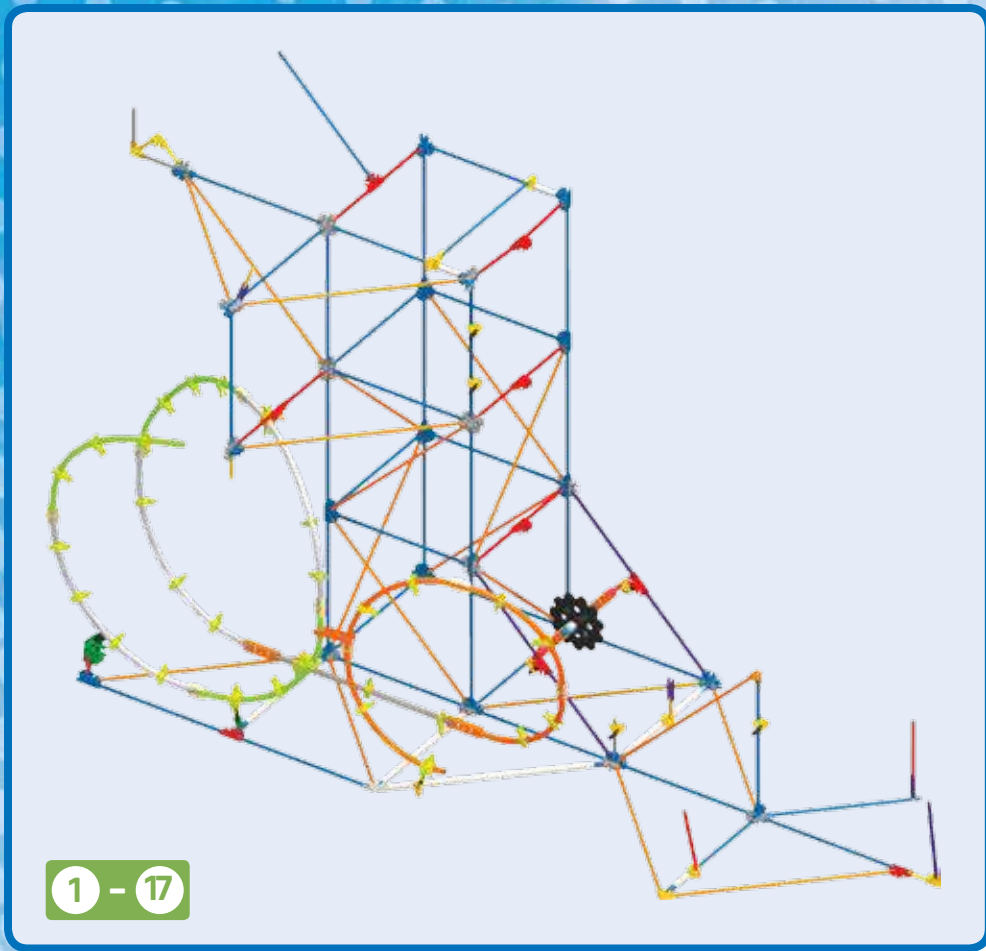

1 - 17



17

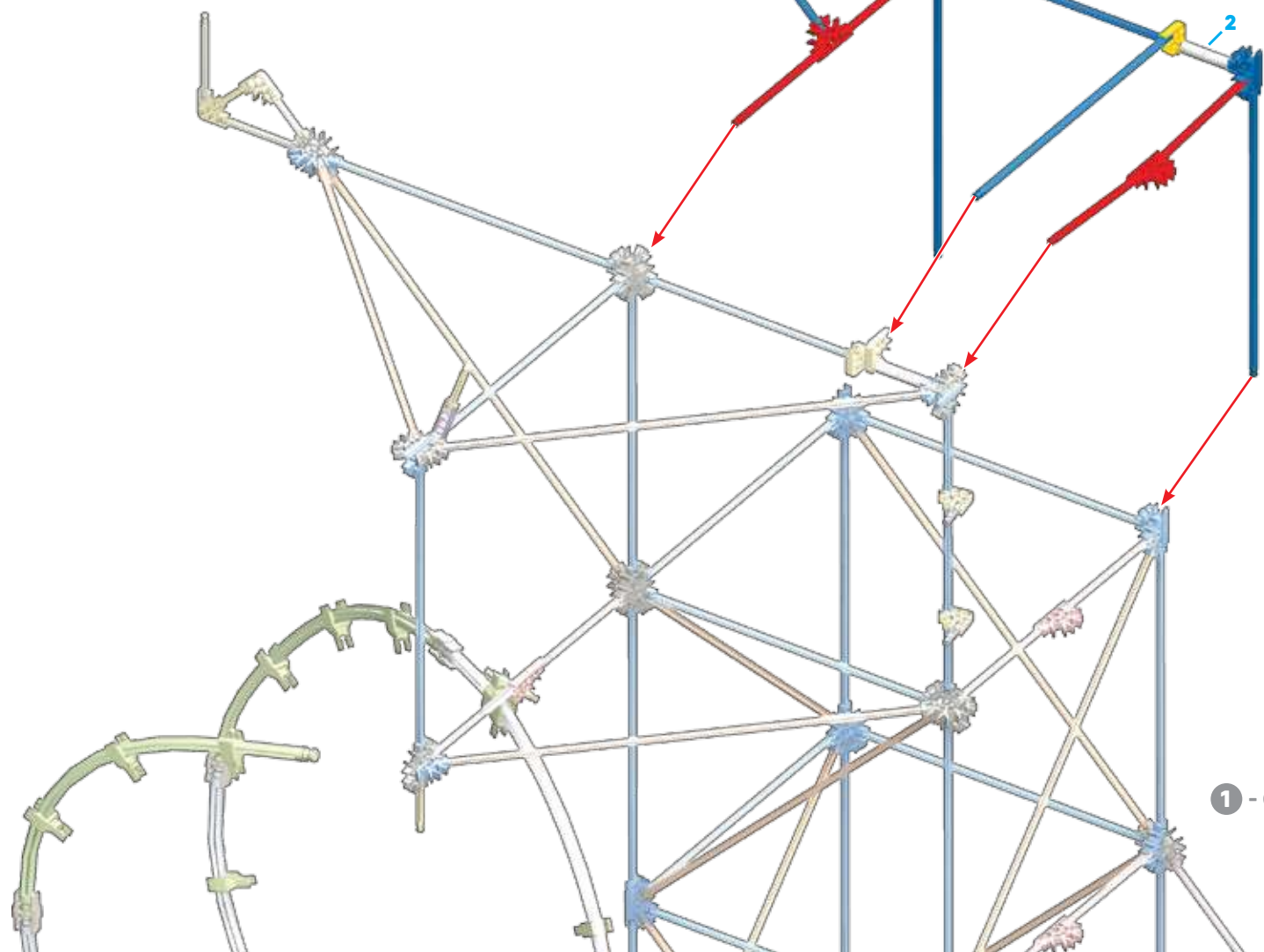

1 - 16

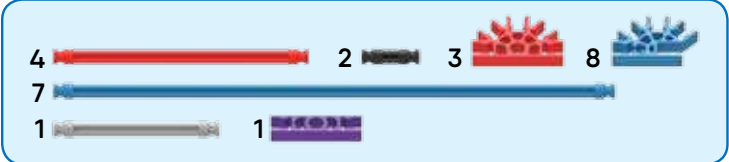
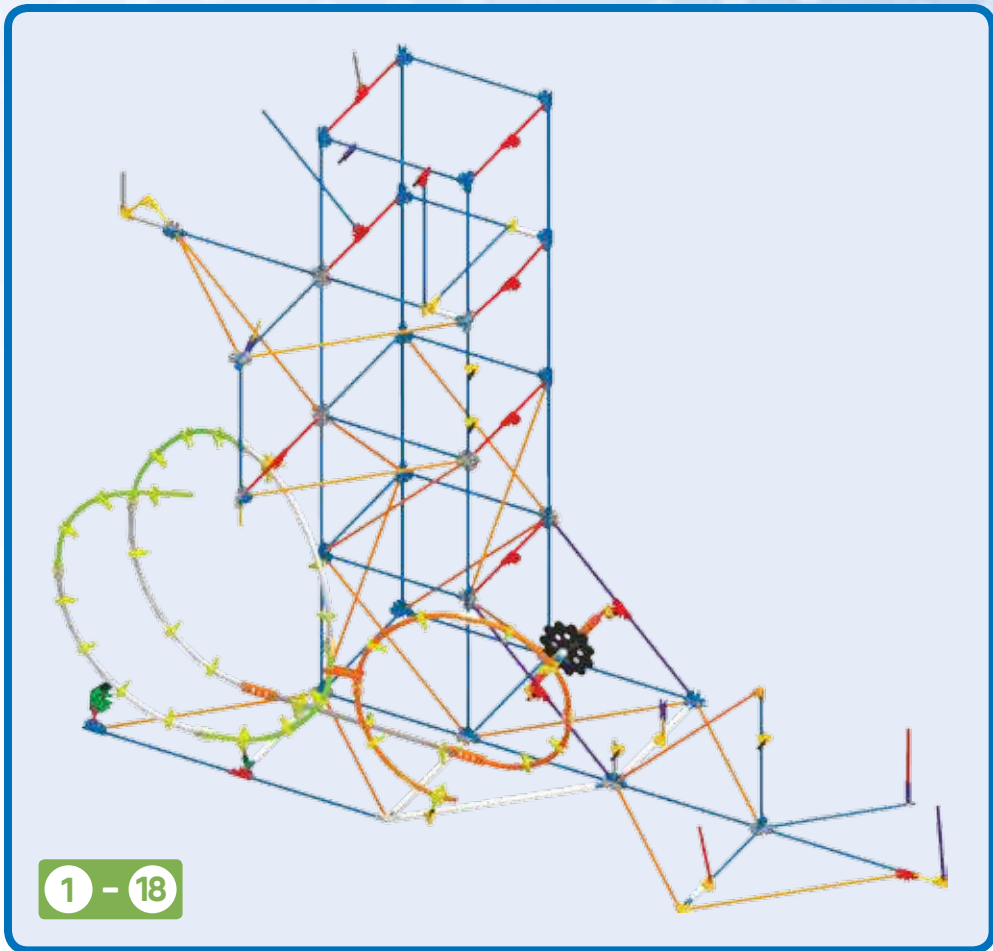

18

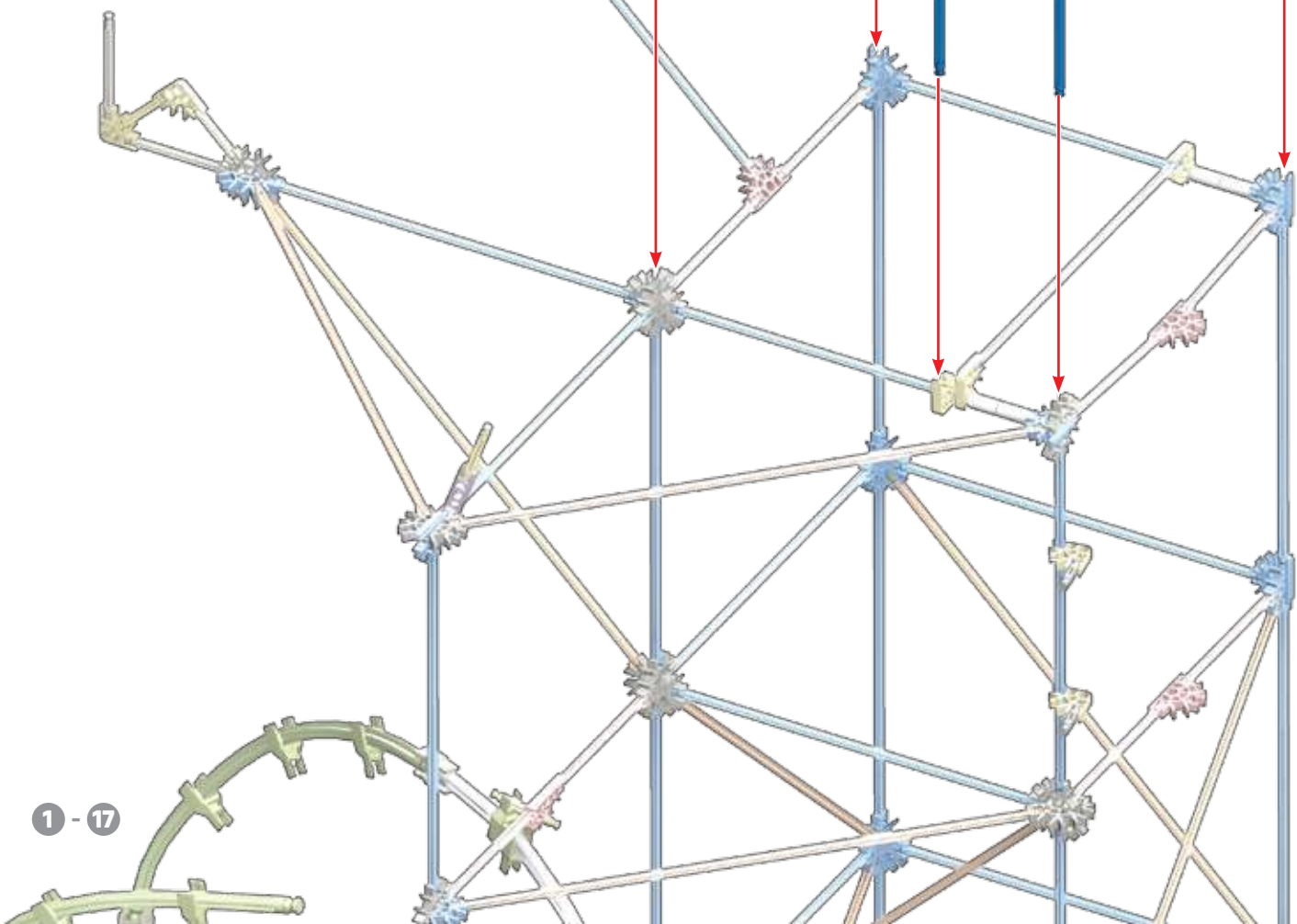
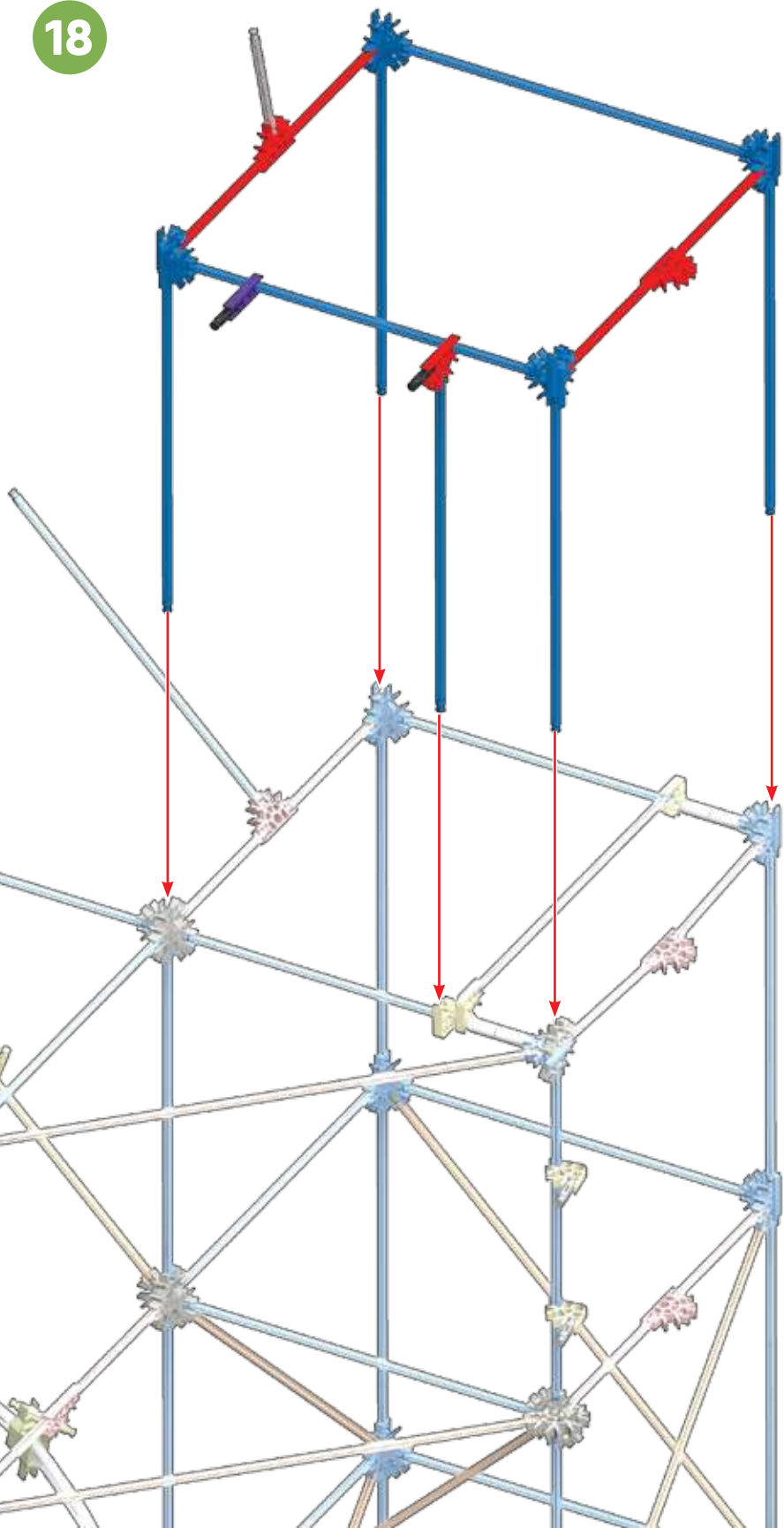

1 - 17

9

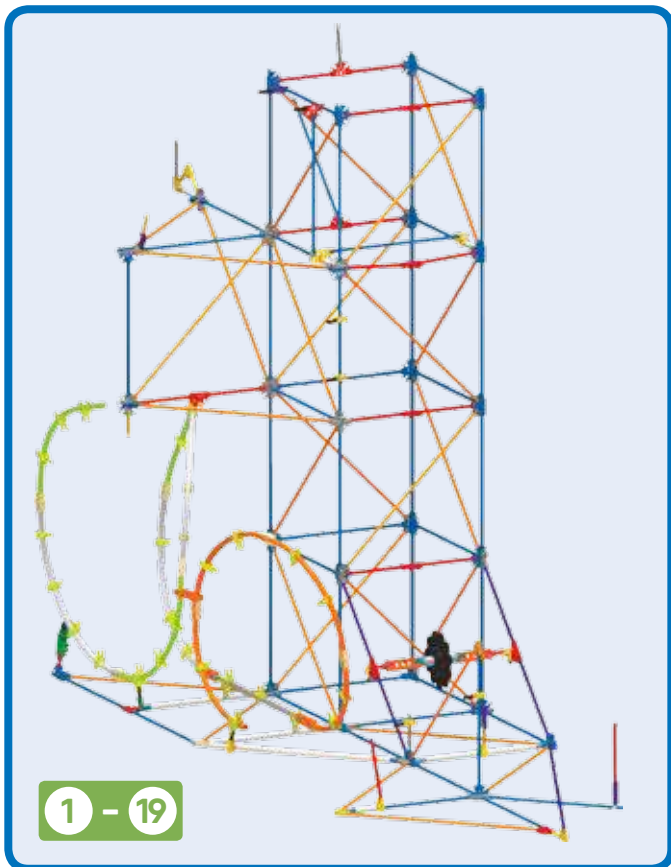

19

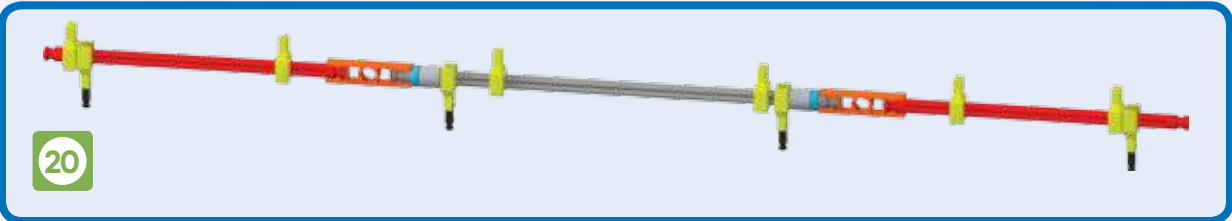
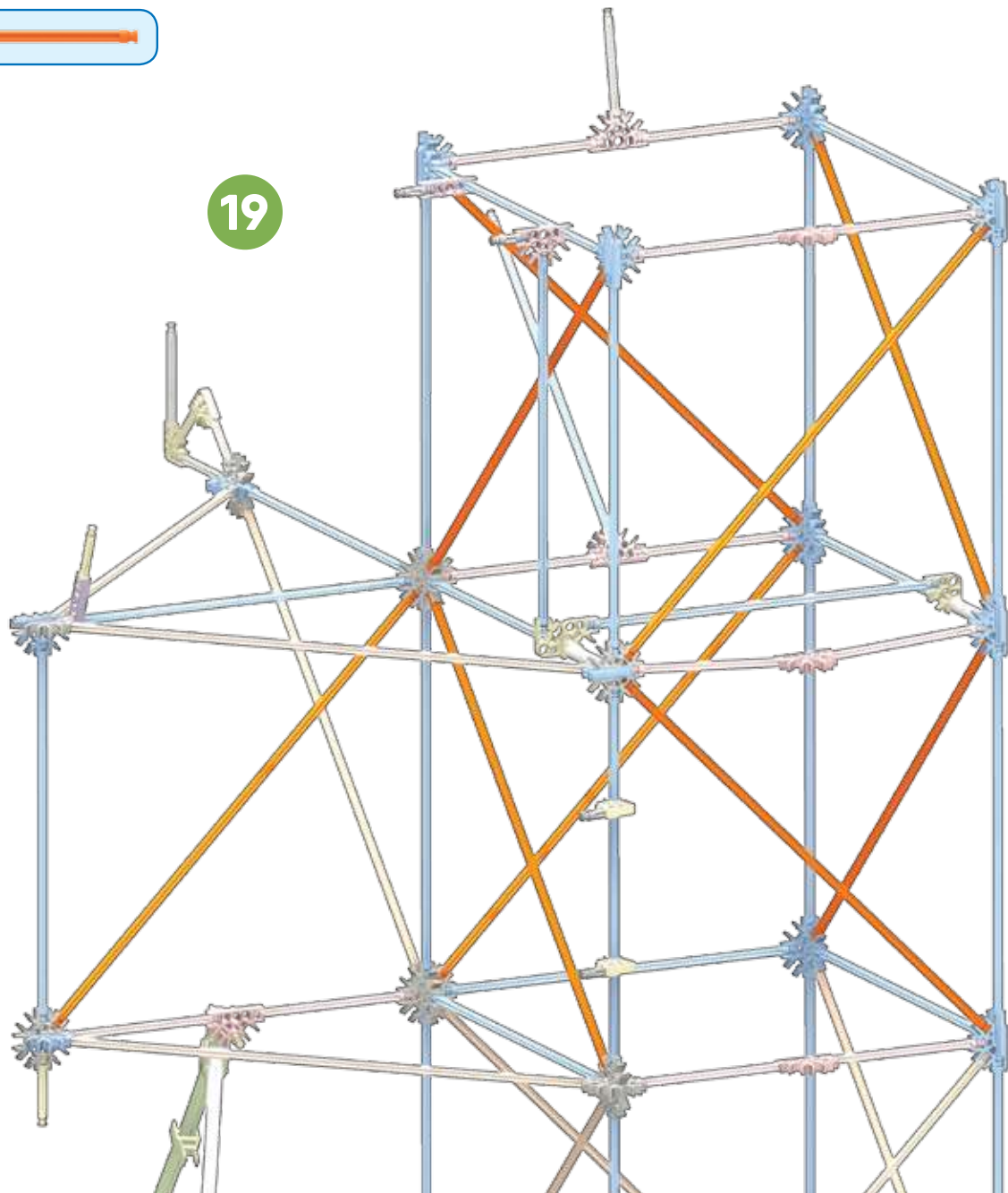
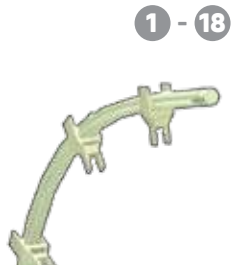

20

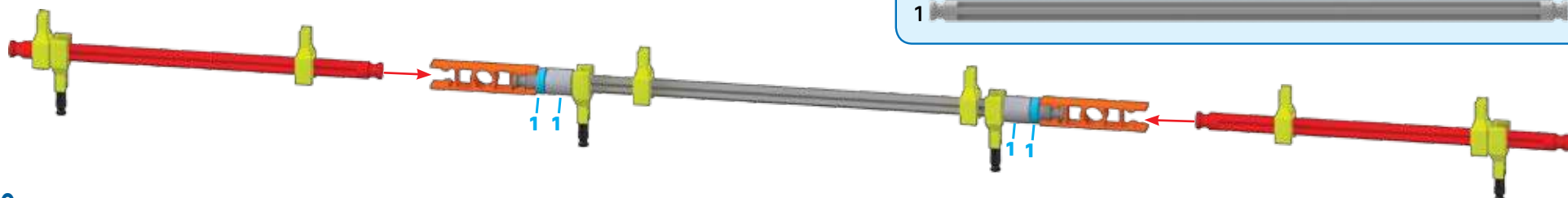

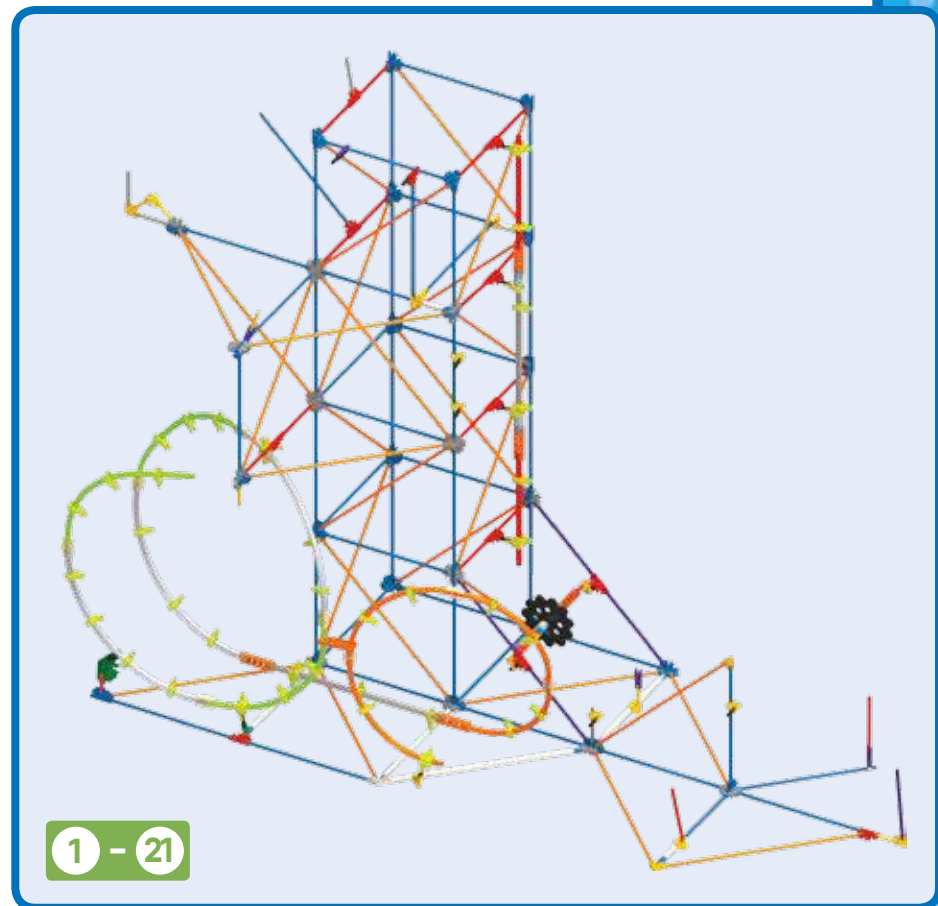
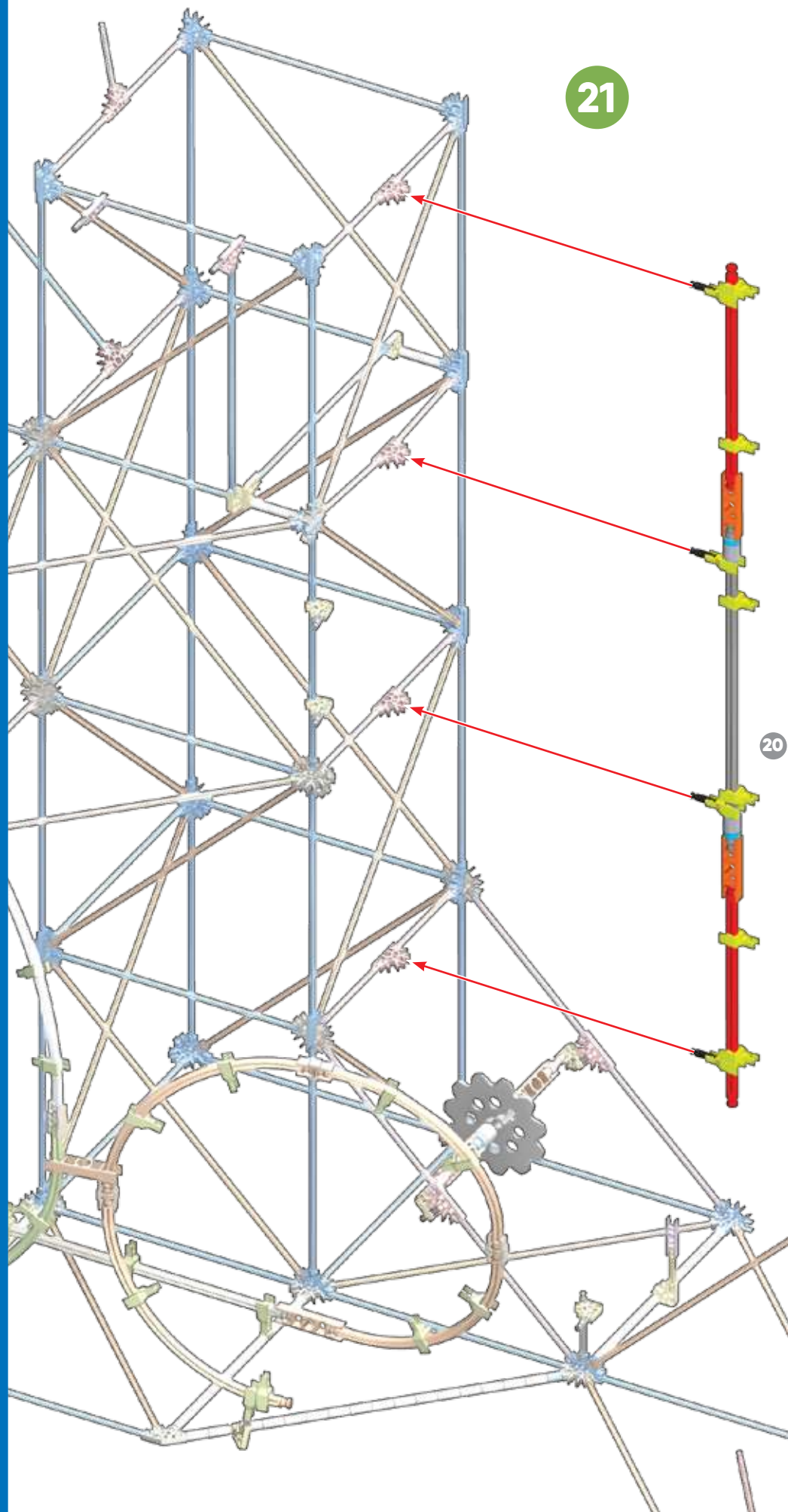

22

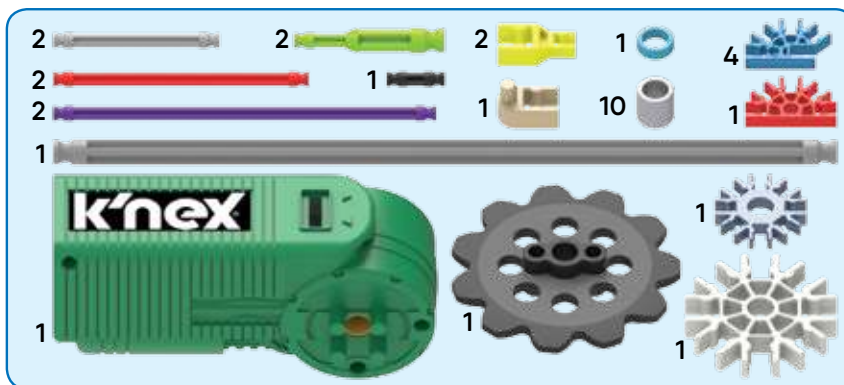
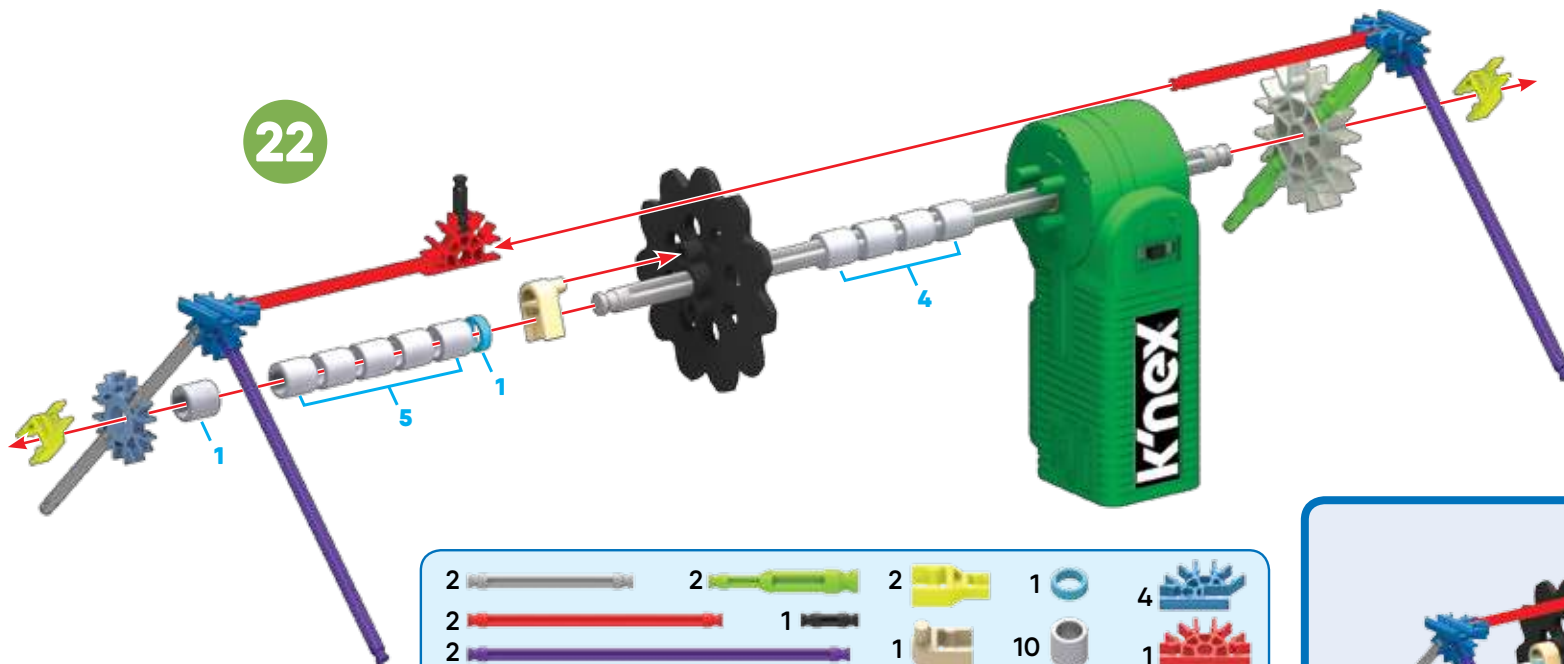

- (EN) Did you install 2 AA (or LR6) batteries in the motor?
- (FR) Avez-vous installé 2 piles AA (ou LR6) ?
- (ES) ¿Instalaste 2 pilas AA (o LR6) en el motor?
- (DE) Hast du 2 AA (oder LR6) Batterien in den Motor eingelegt?
- (IT) Hai installato 2 batterie AA (o LR6) nel motore?
- (PT) Foram instaladas as pilhas 2 AA (ou LR6) no motor?
- (NL) Heb je 2 AA (of LR6)-batterijen in de motor geplaatst?



23

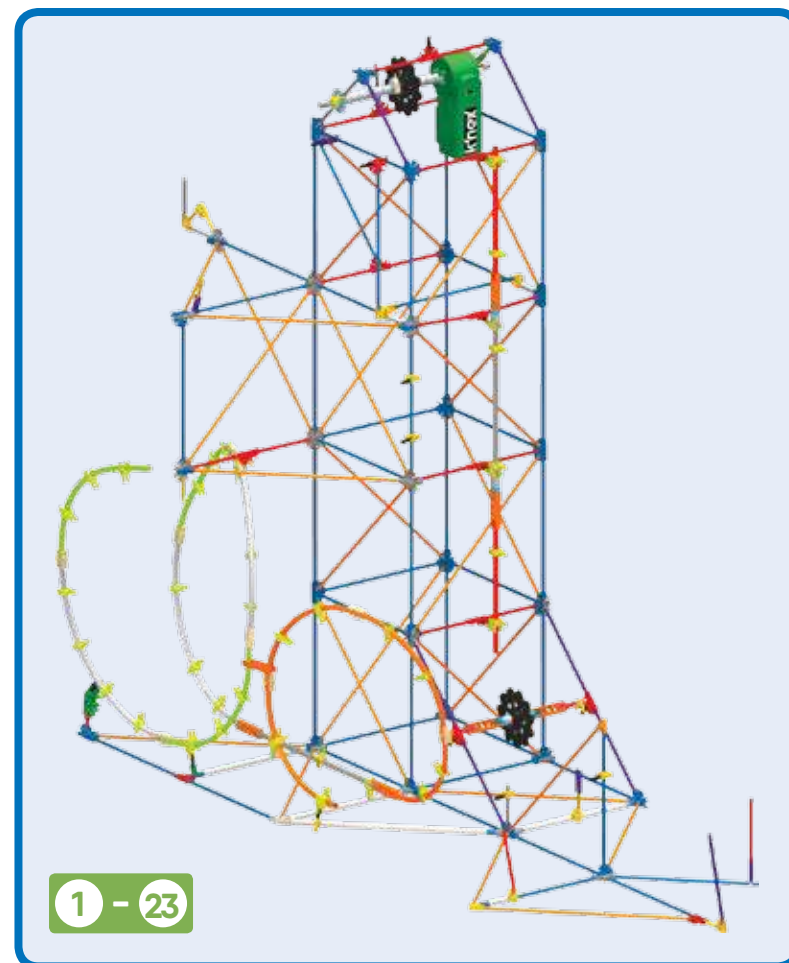
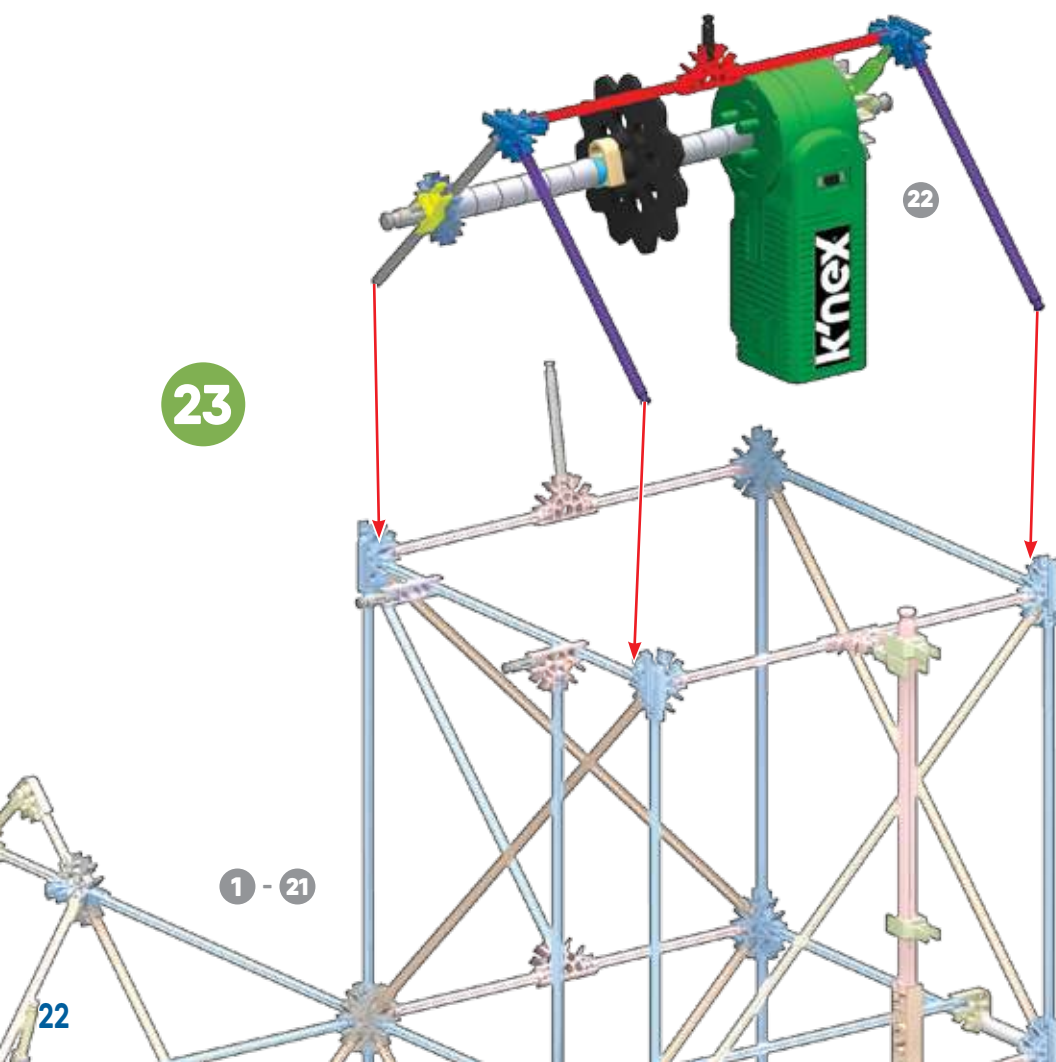

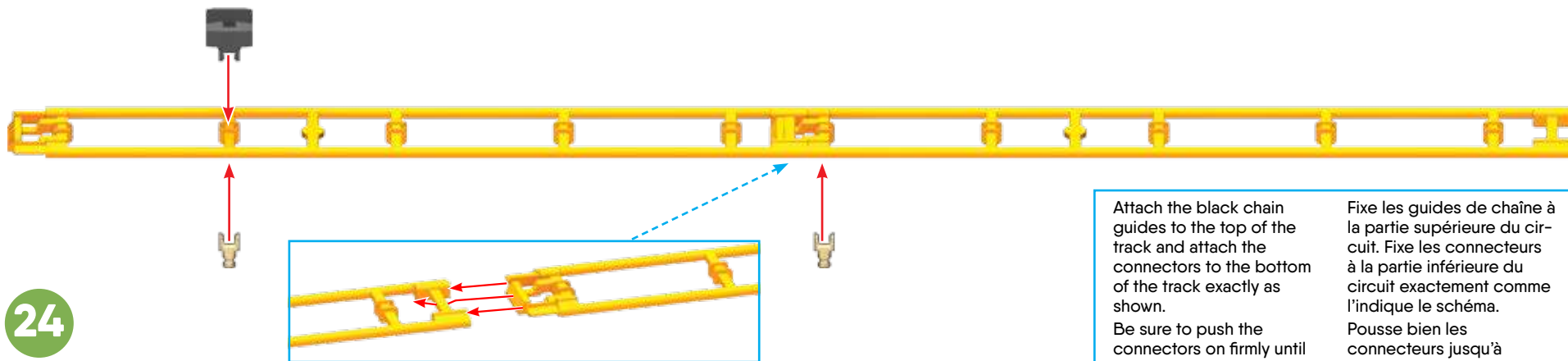

24

Attach the black chain guides to the top of the track and attach the connectors to the bottom of the track exactly as shown. Be sure to push the connectors on firmly until they "click".

Fixe les guides de chaîne à la partie supérieure du circuit. Fixe les connecteurs à la partie inférieure du circuit exactement comme l'indique le schéma. Pousse bien les connecteurs jusqu'à ce qu'ils « cliquent ».

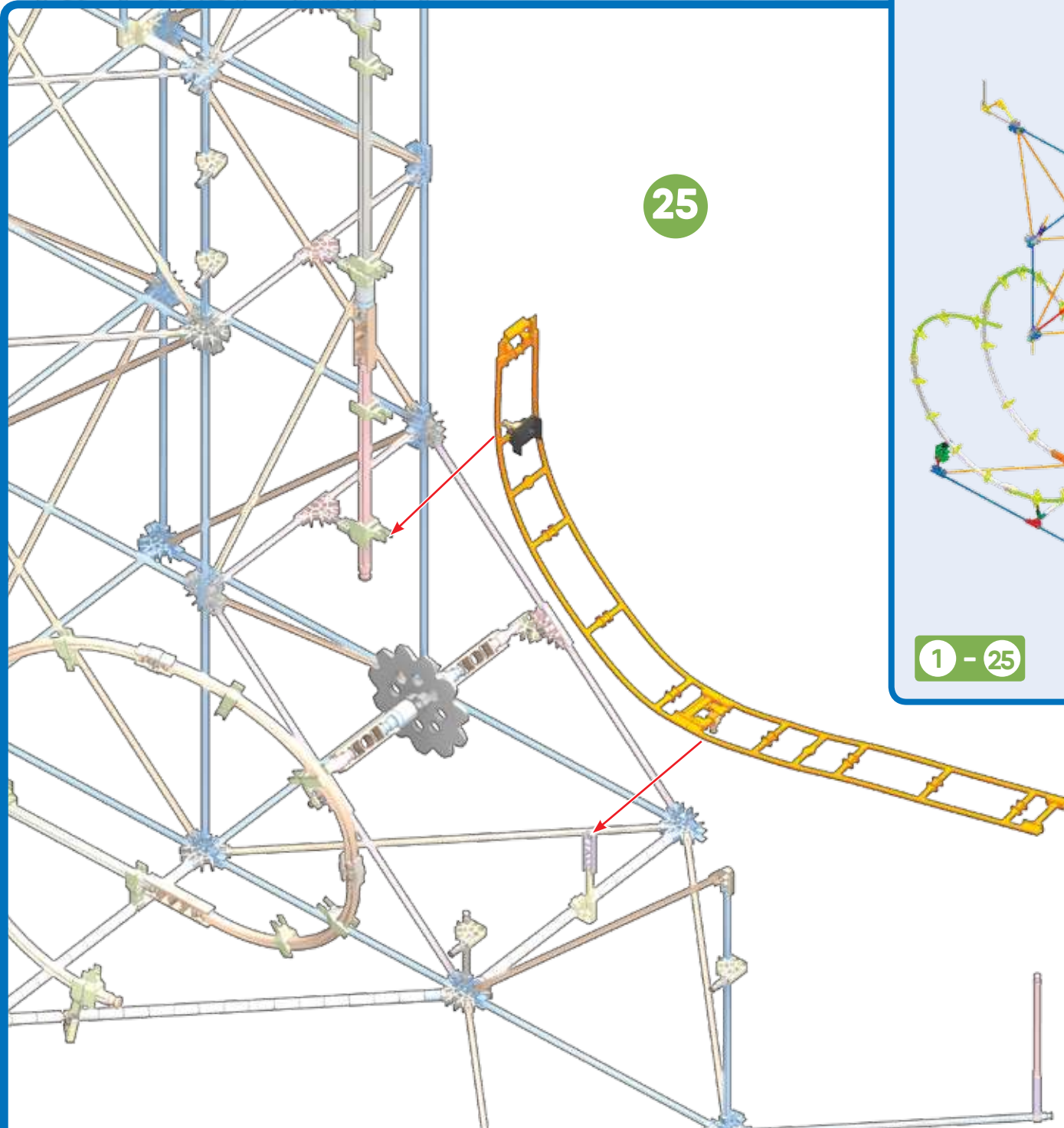

25

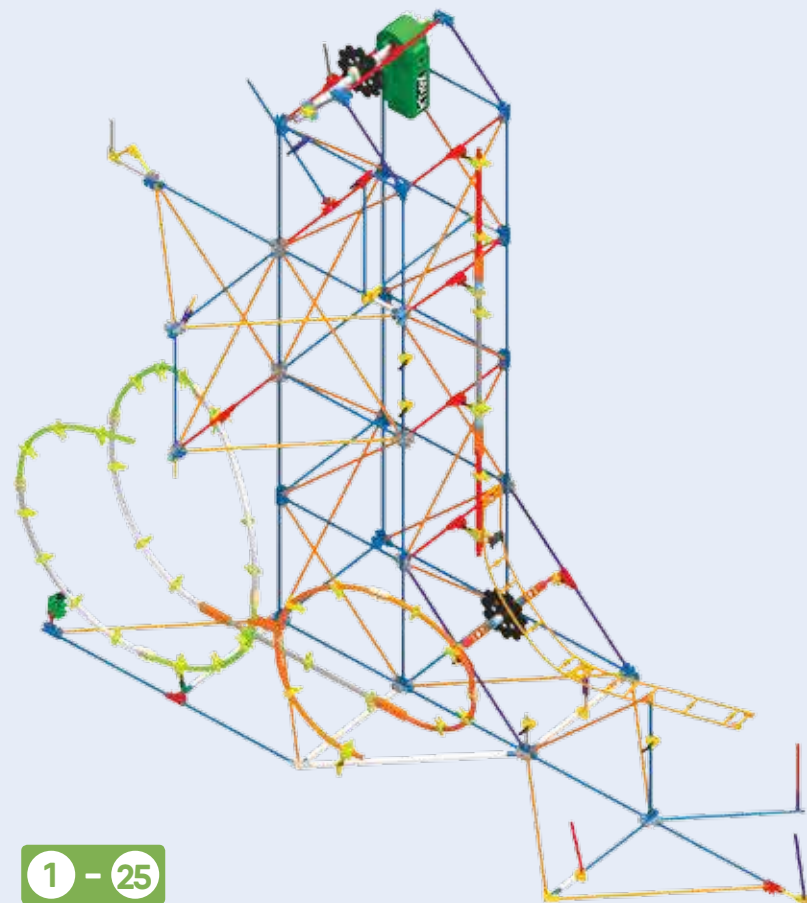

1 - 25

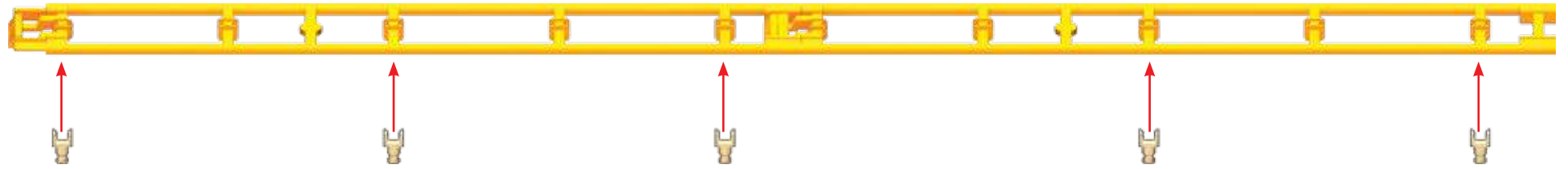

26

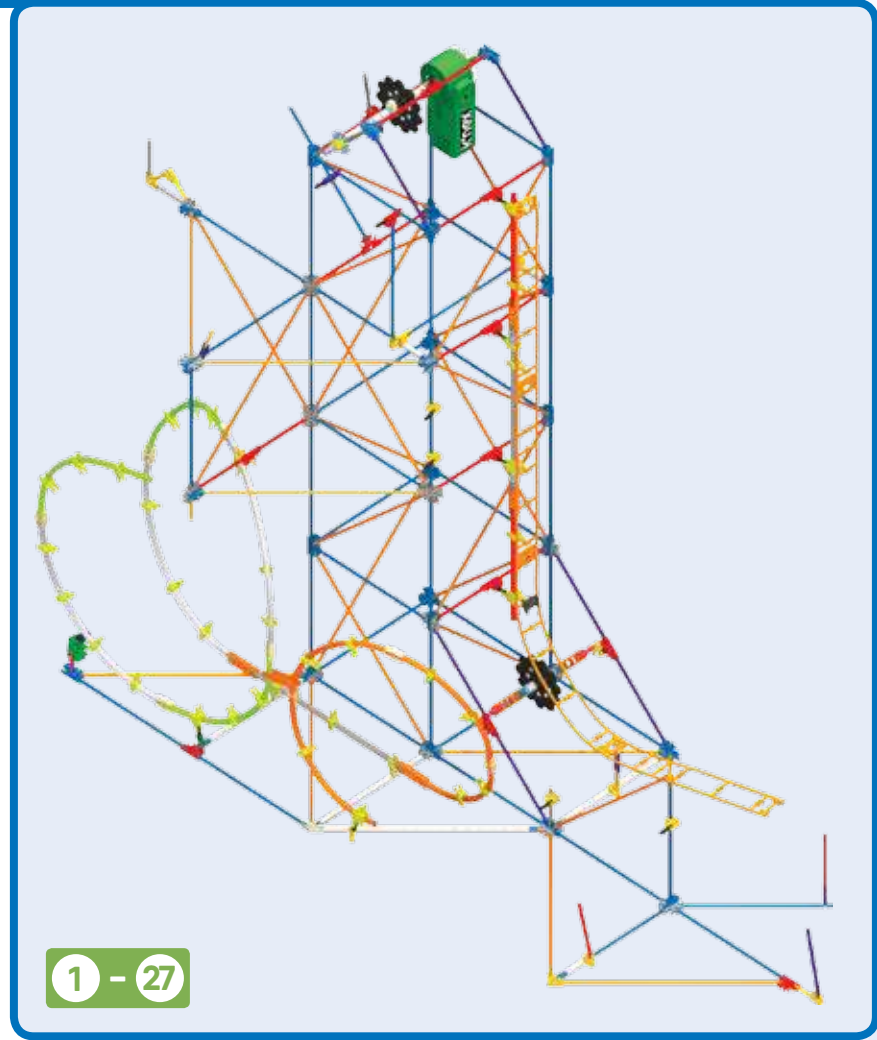
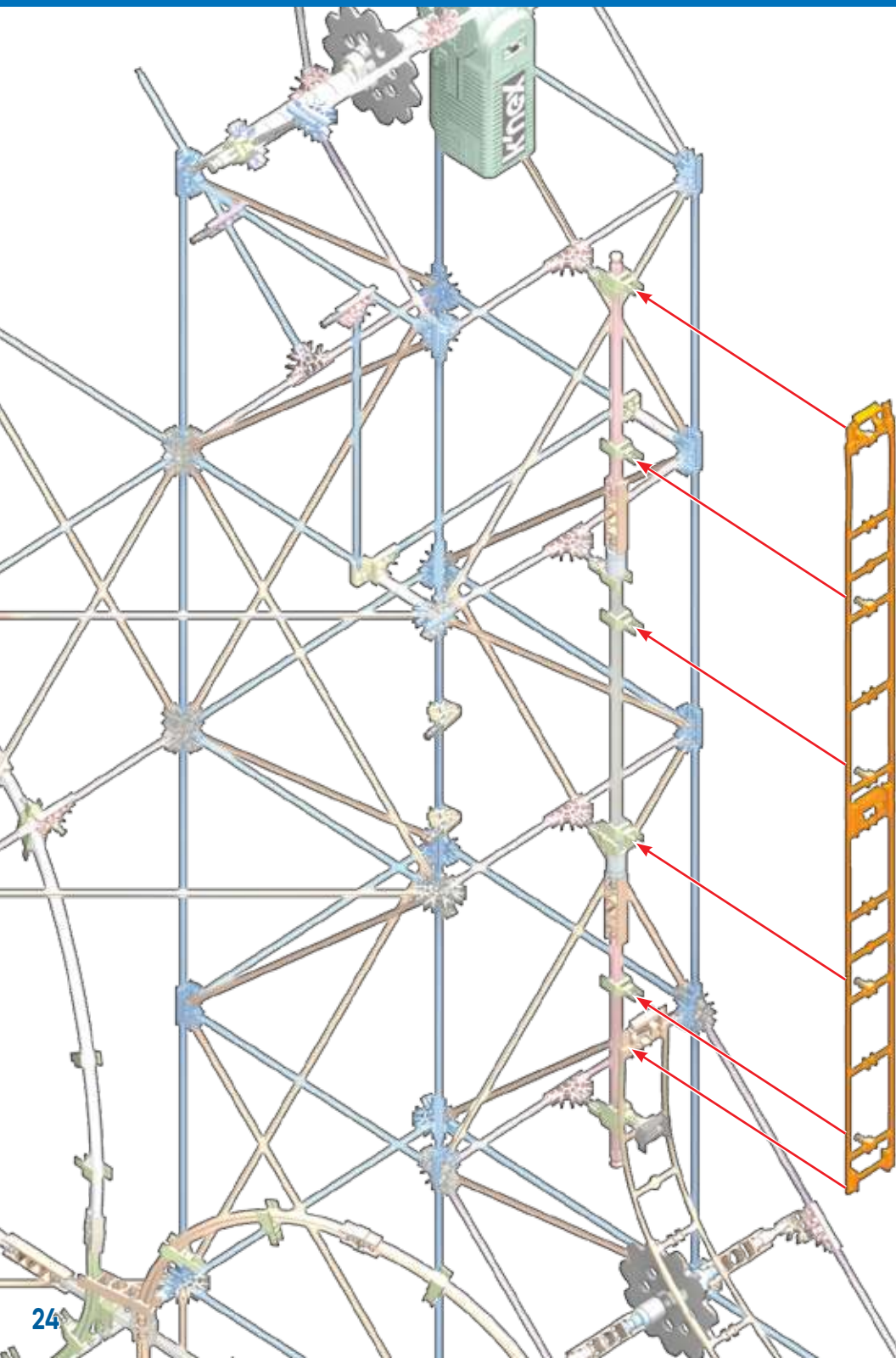

27

Always join this end of the track to the previous track piece first, then connect the rest of the track to the tower.

Toujours joindre à cette extrémité de la voie à la pièce de la piste précédente, puis connecter le reste de la piste à la tour.

28

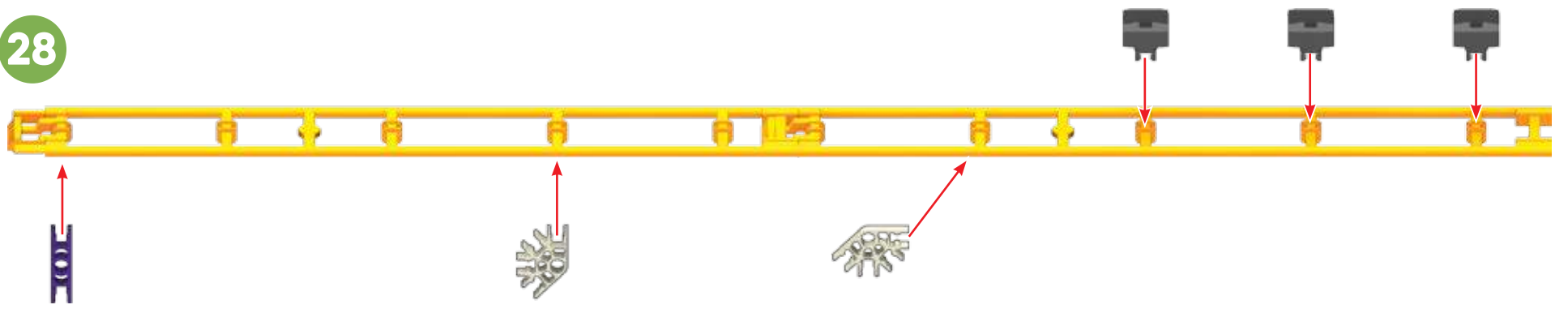

29

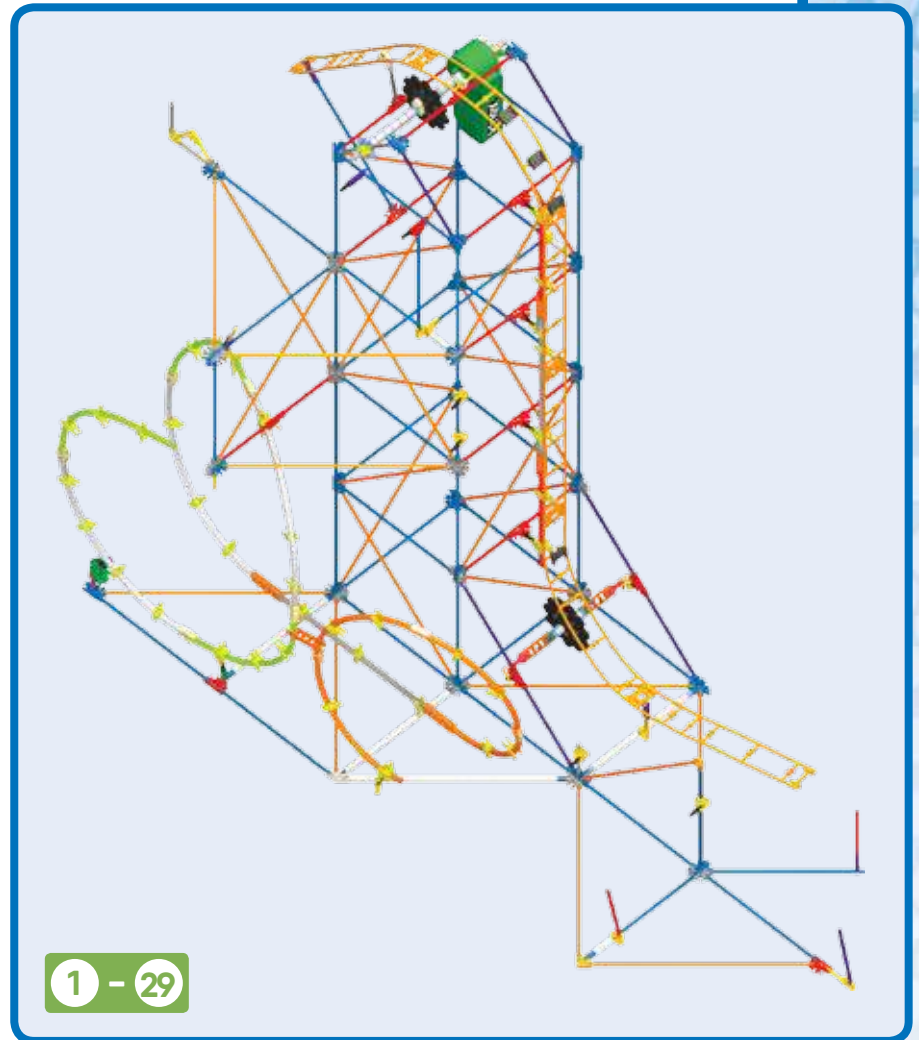
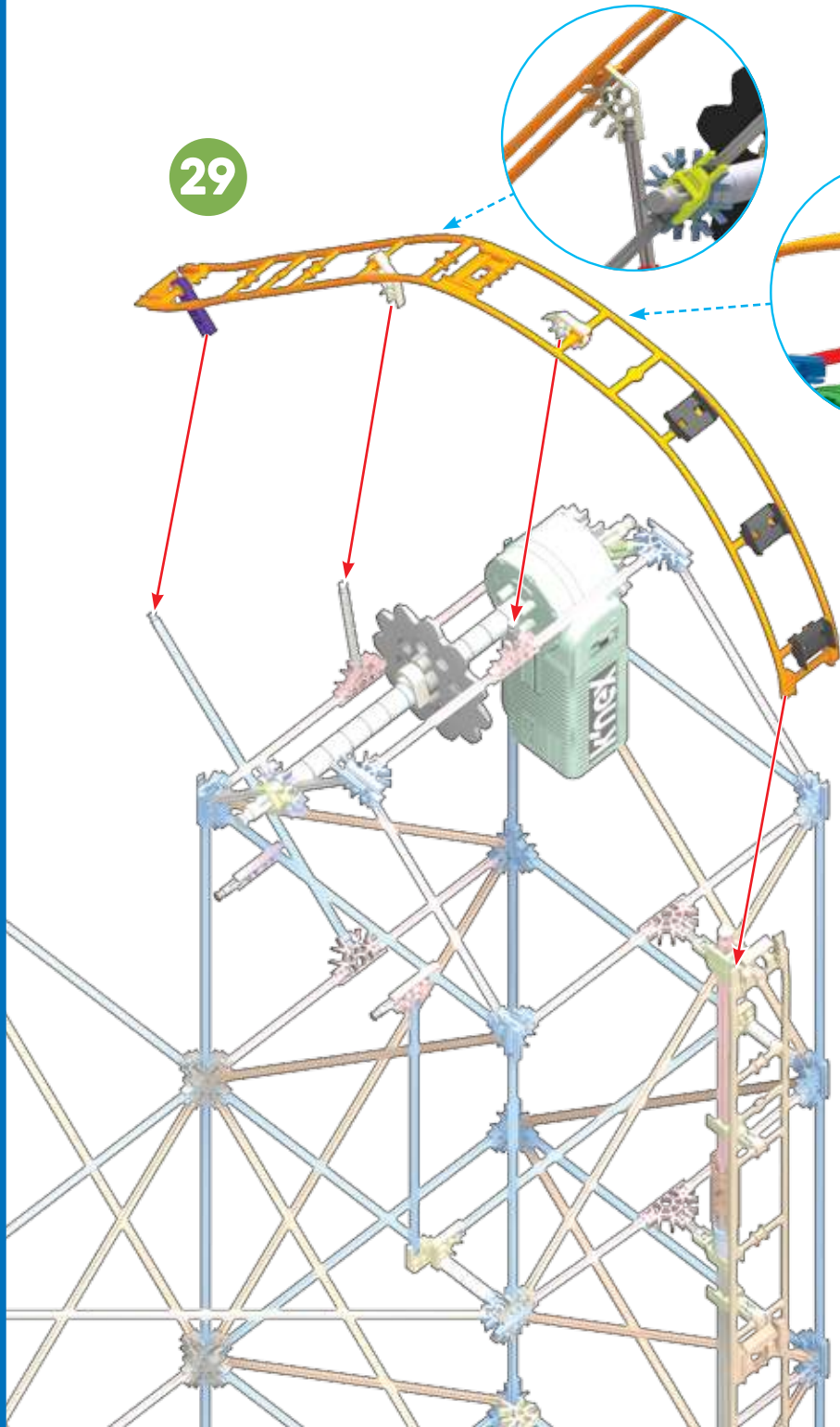

1 - 29

30

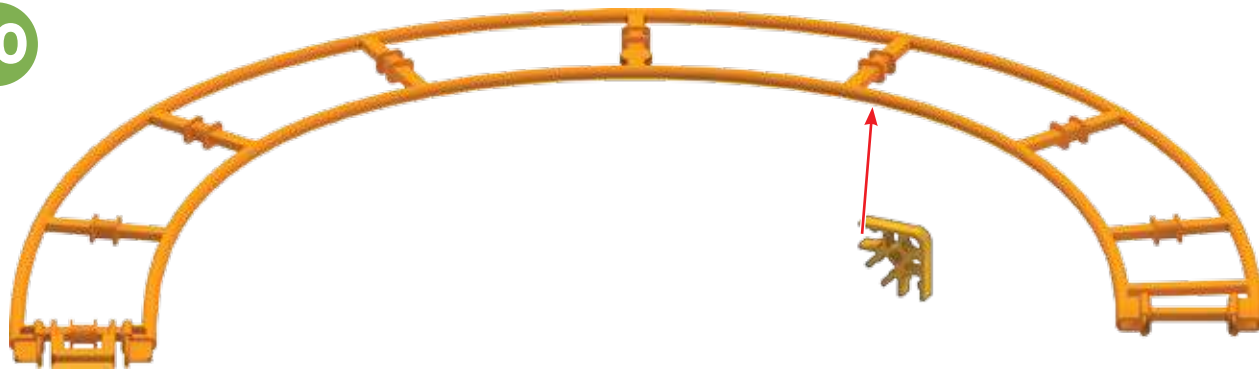

31

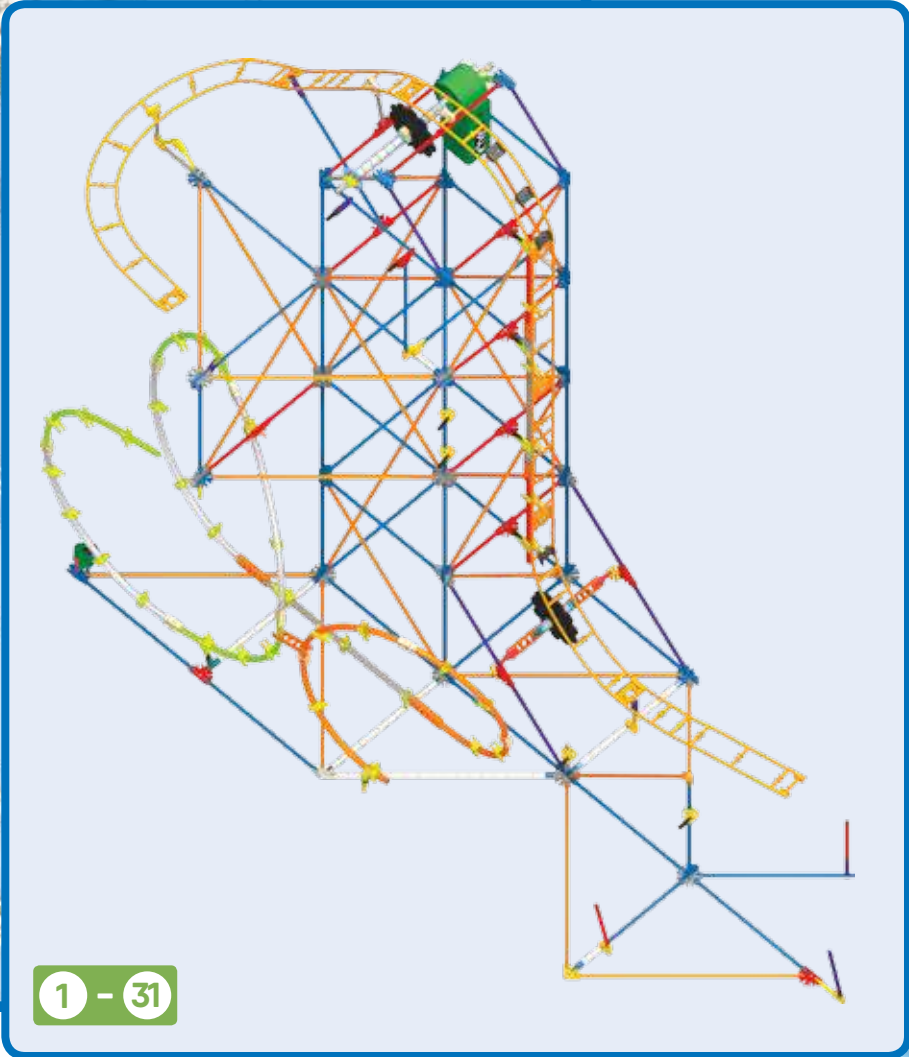
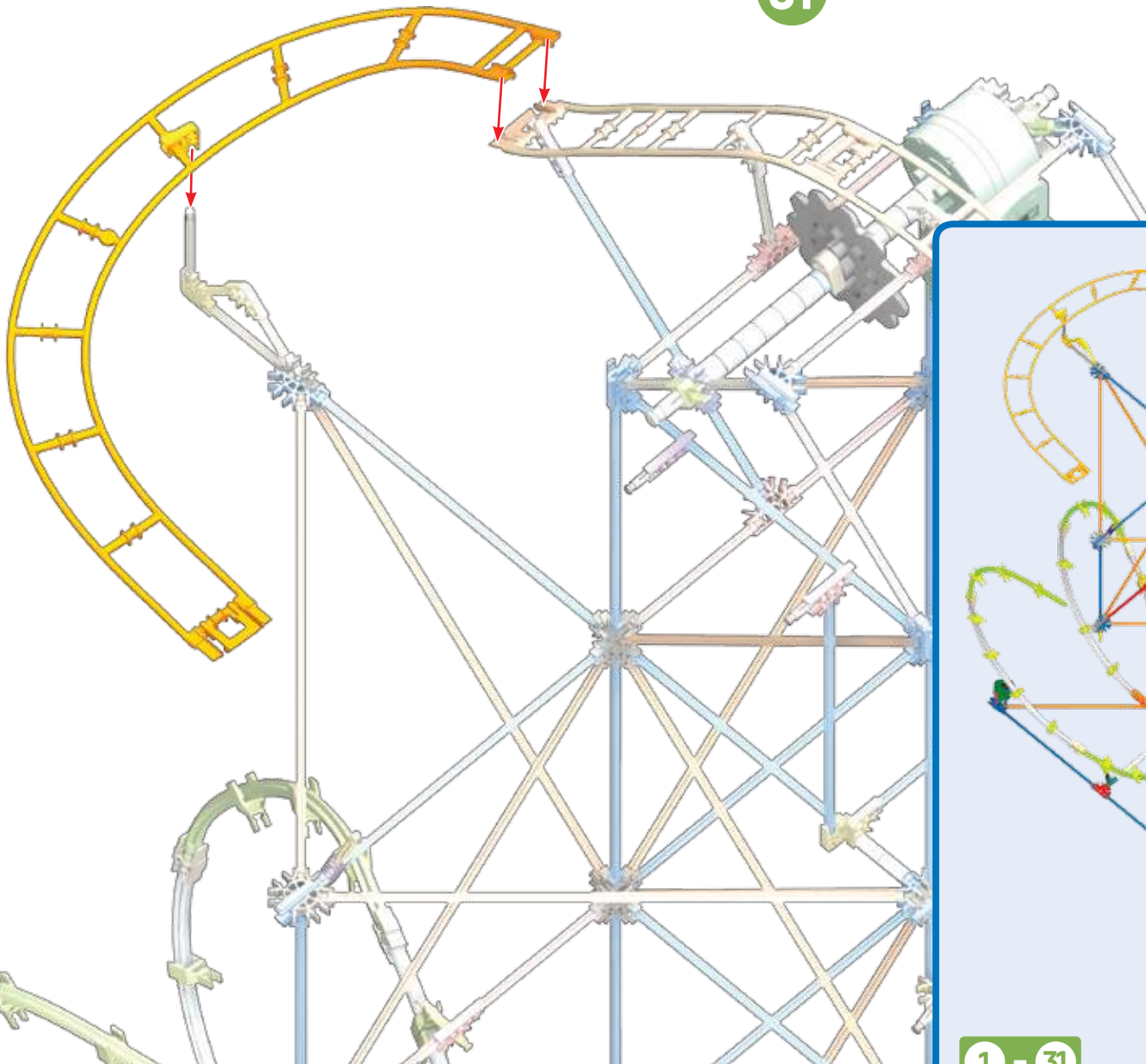

1 - 31



32

棚

33



1 - 33

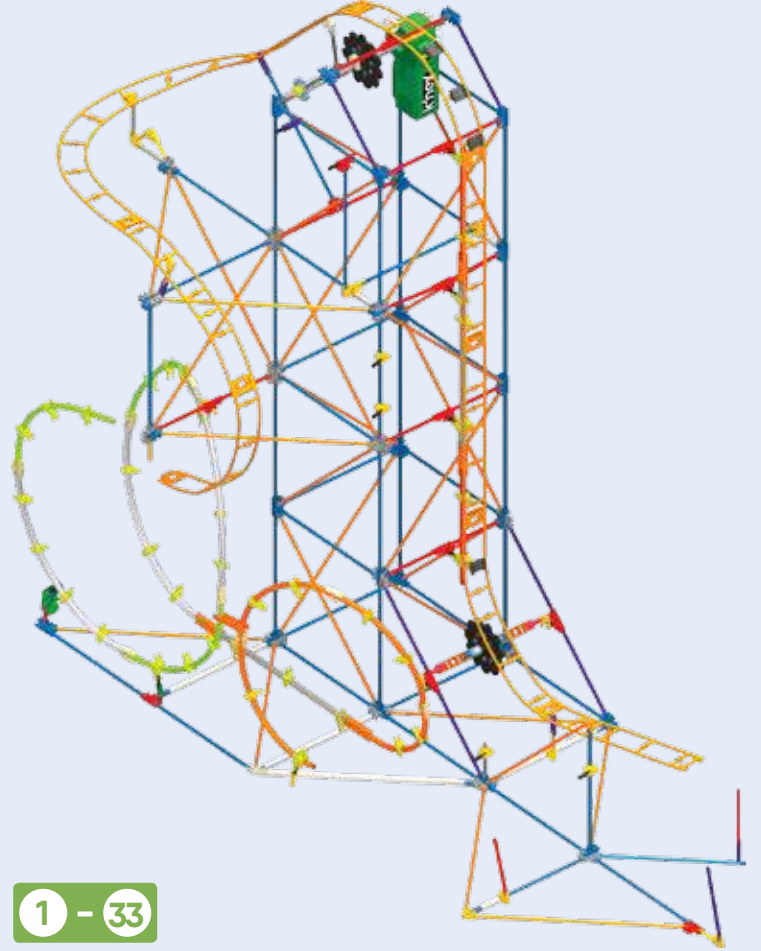

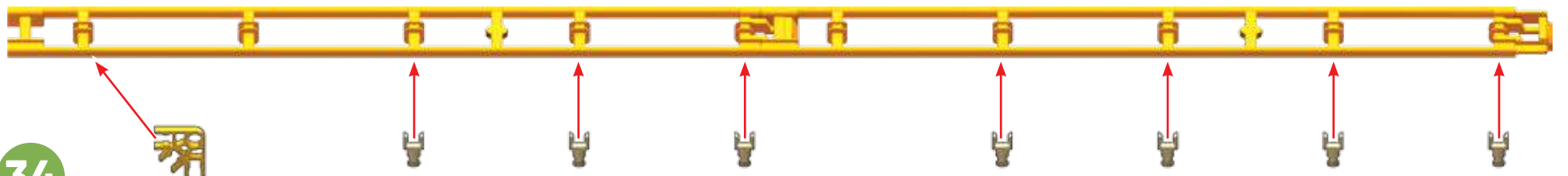

34

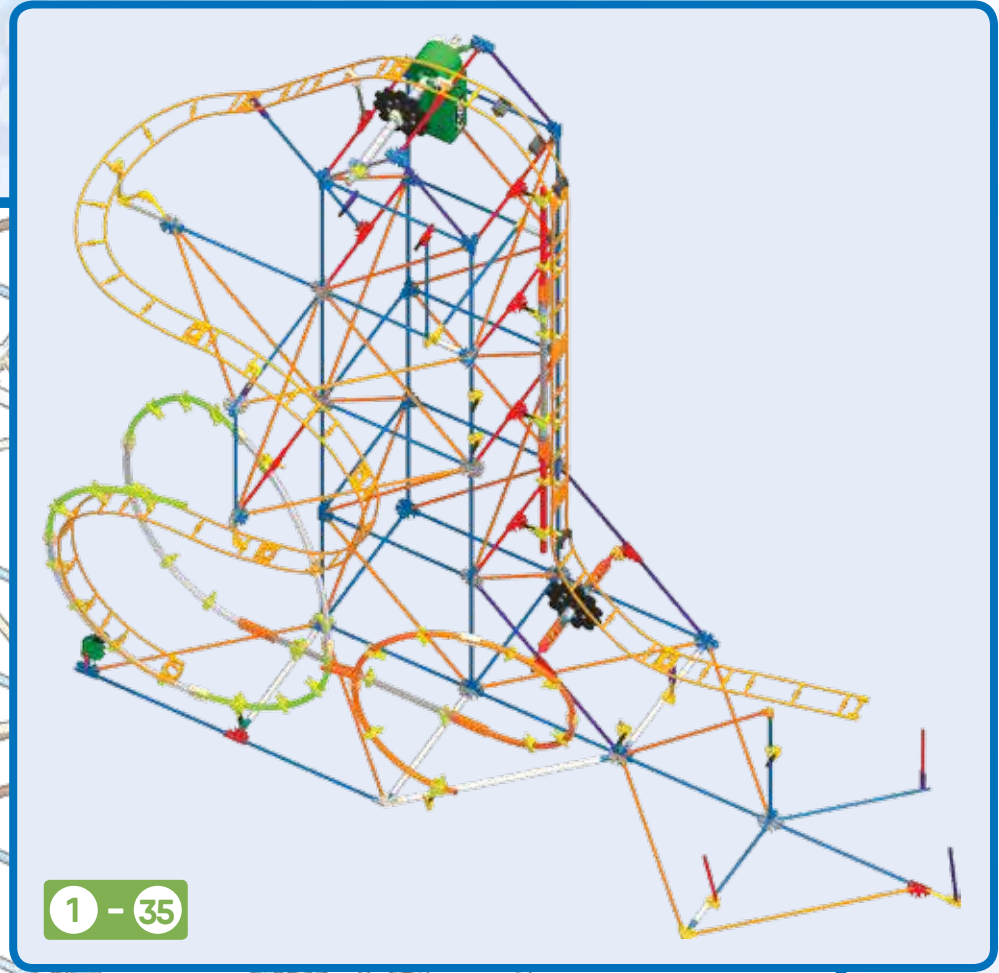

1 - 35

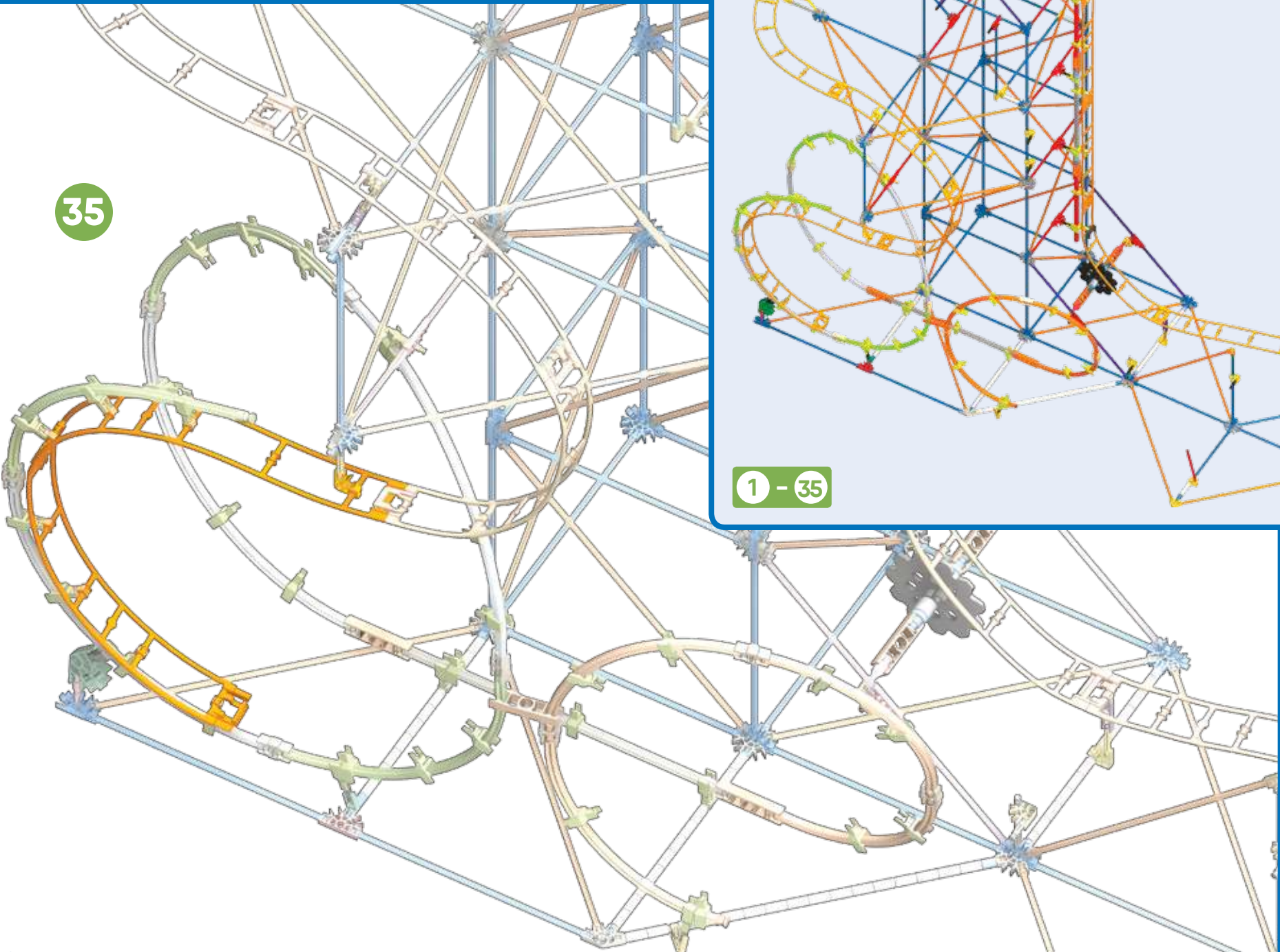

35

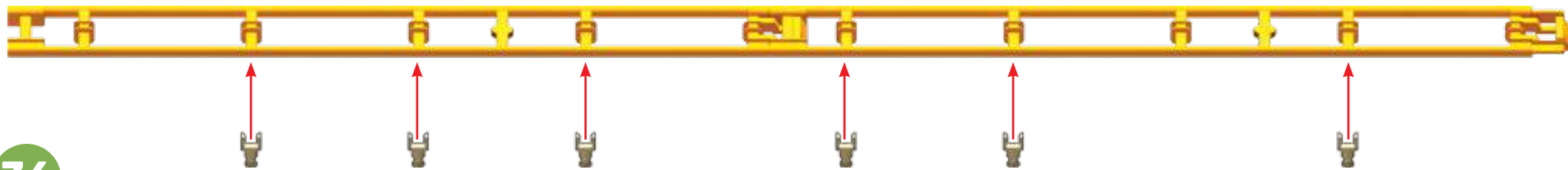

36

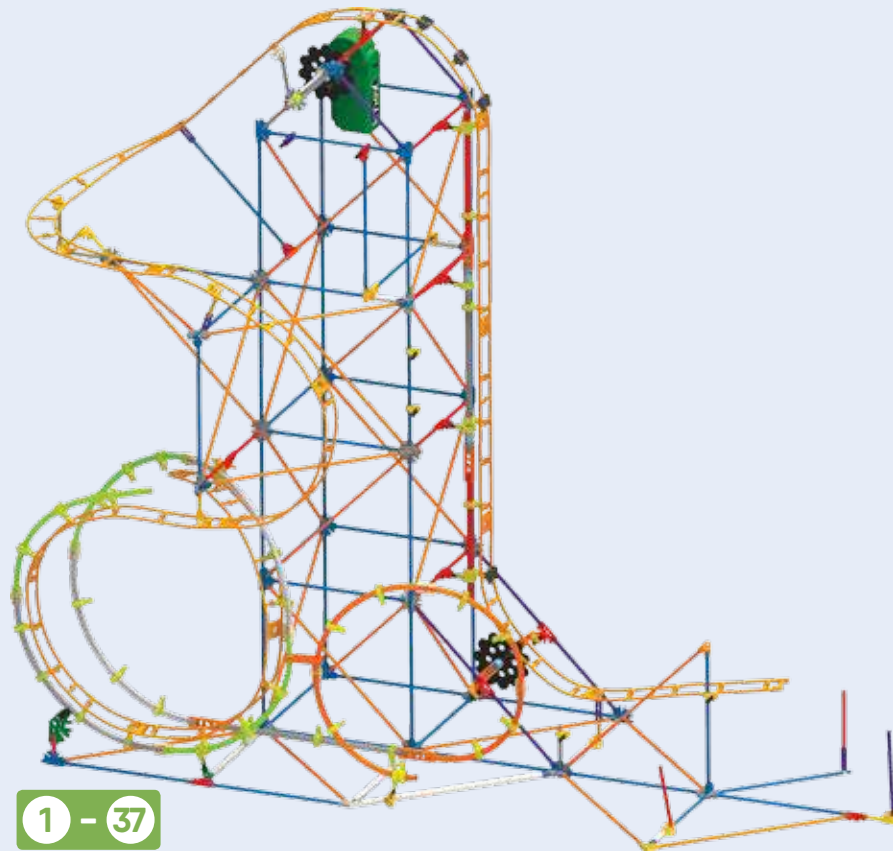

1 - 37

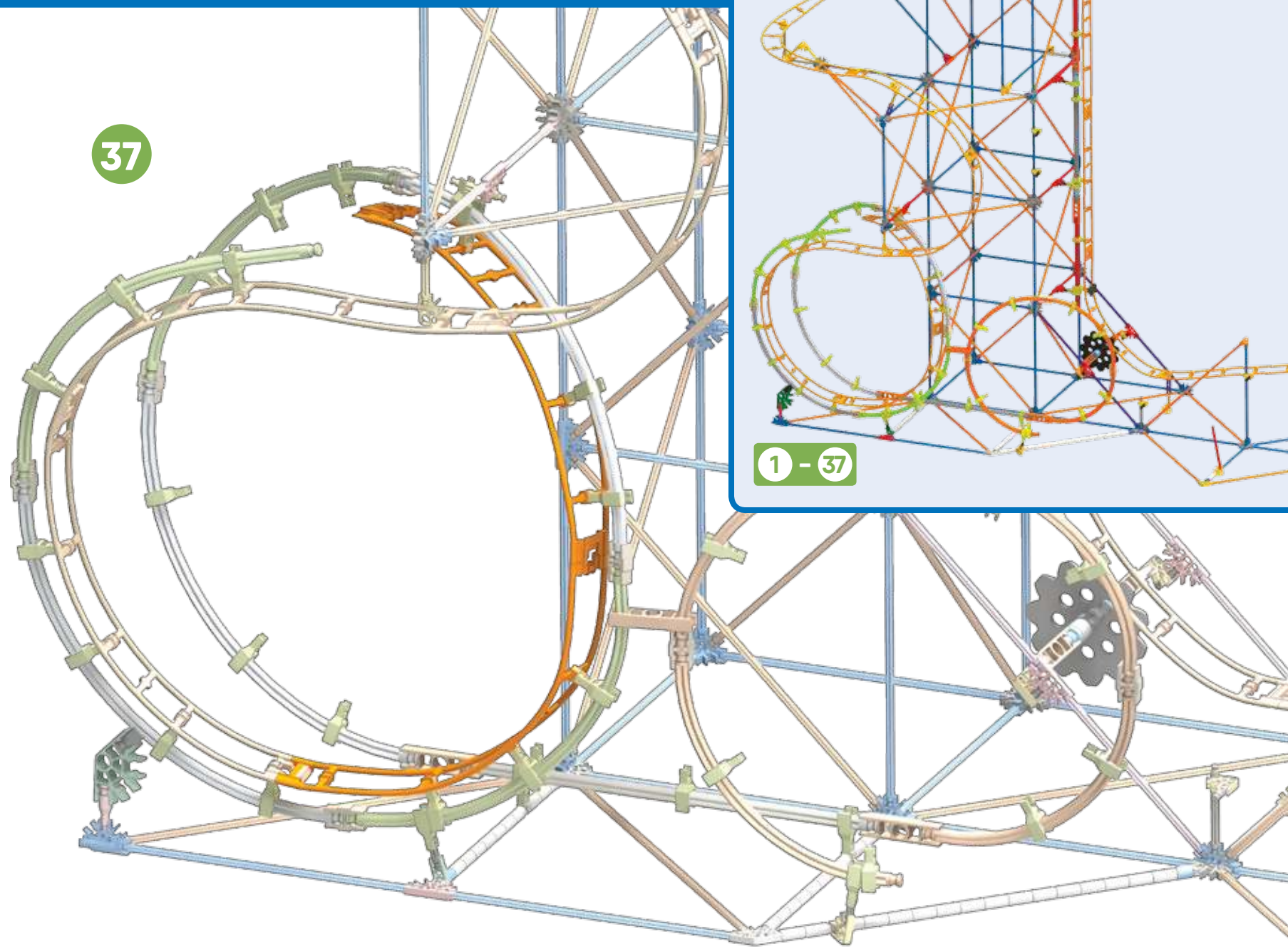

37

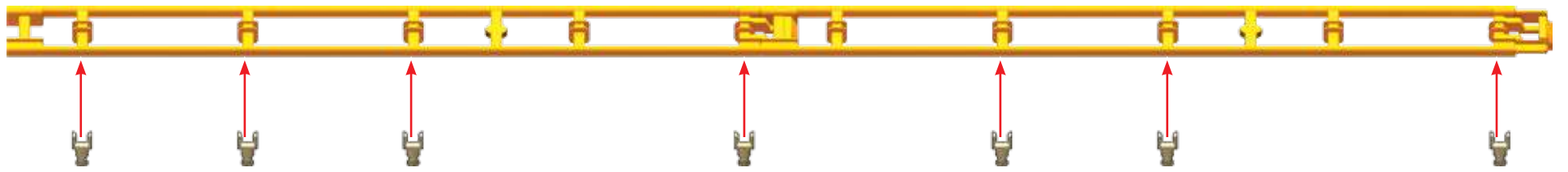

38

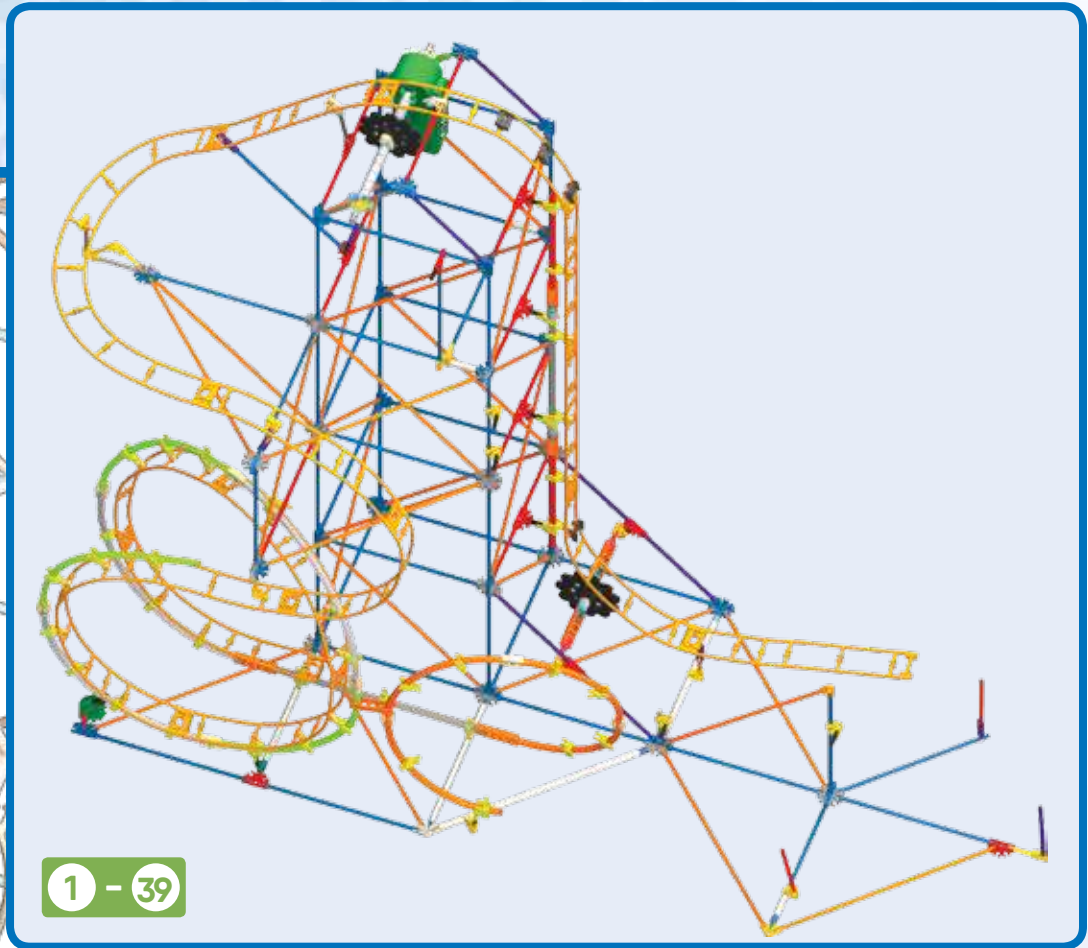

1 - 39

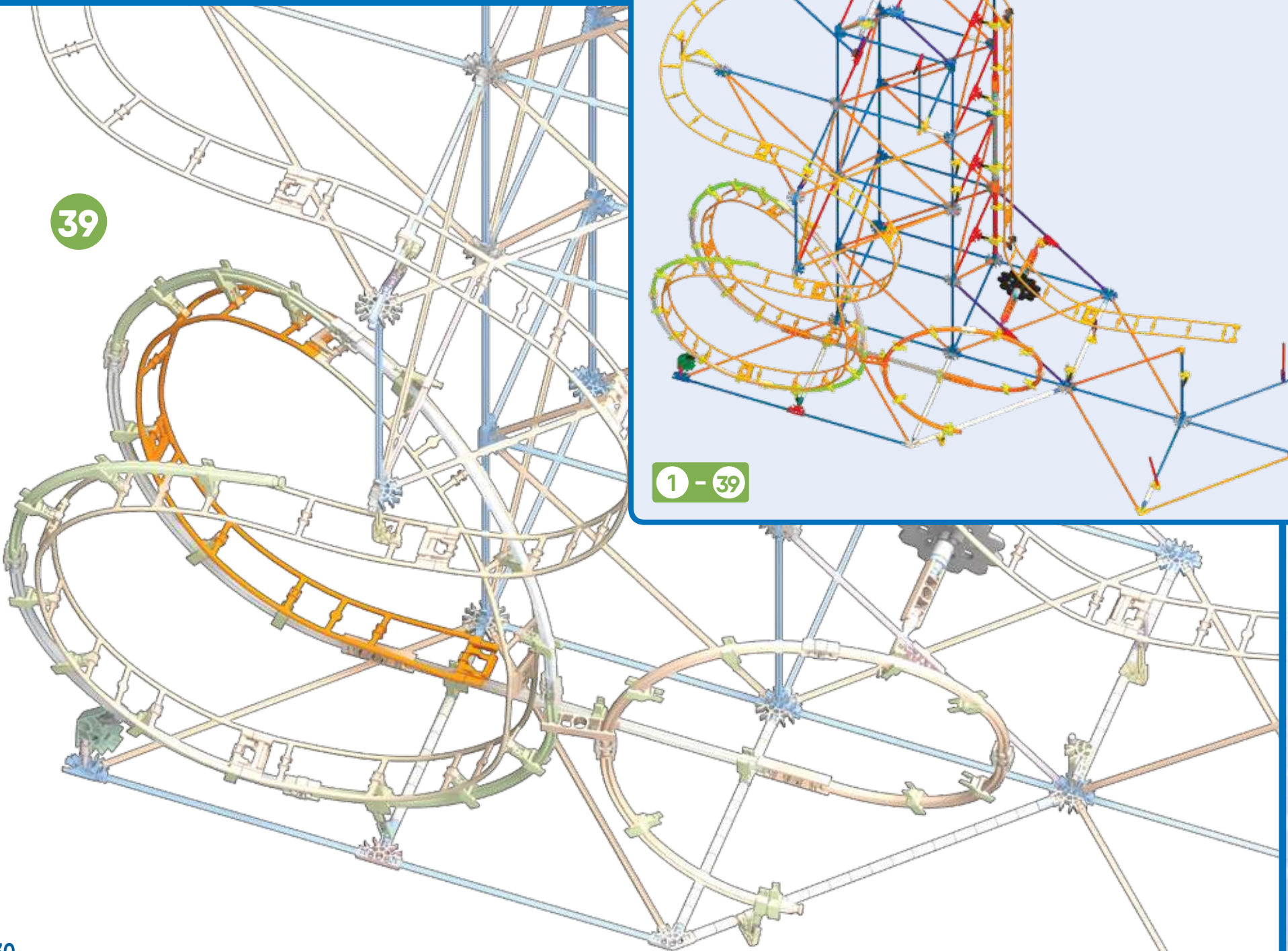

39

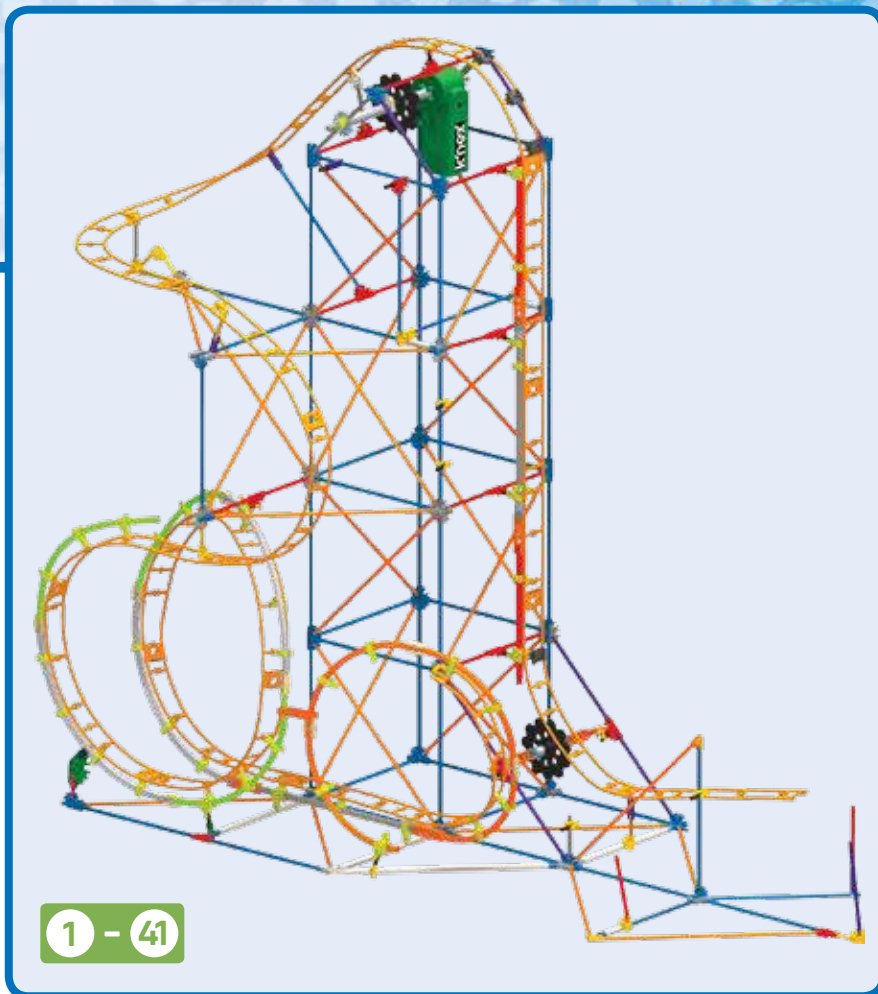
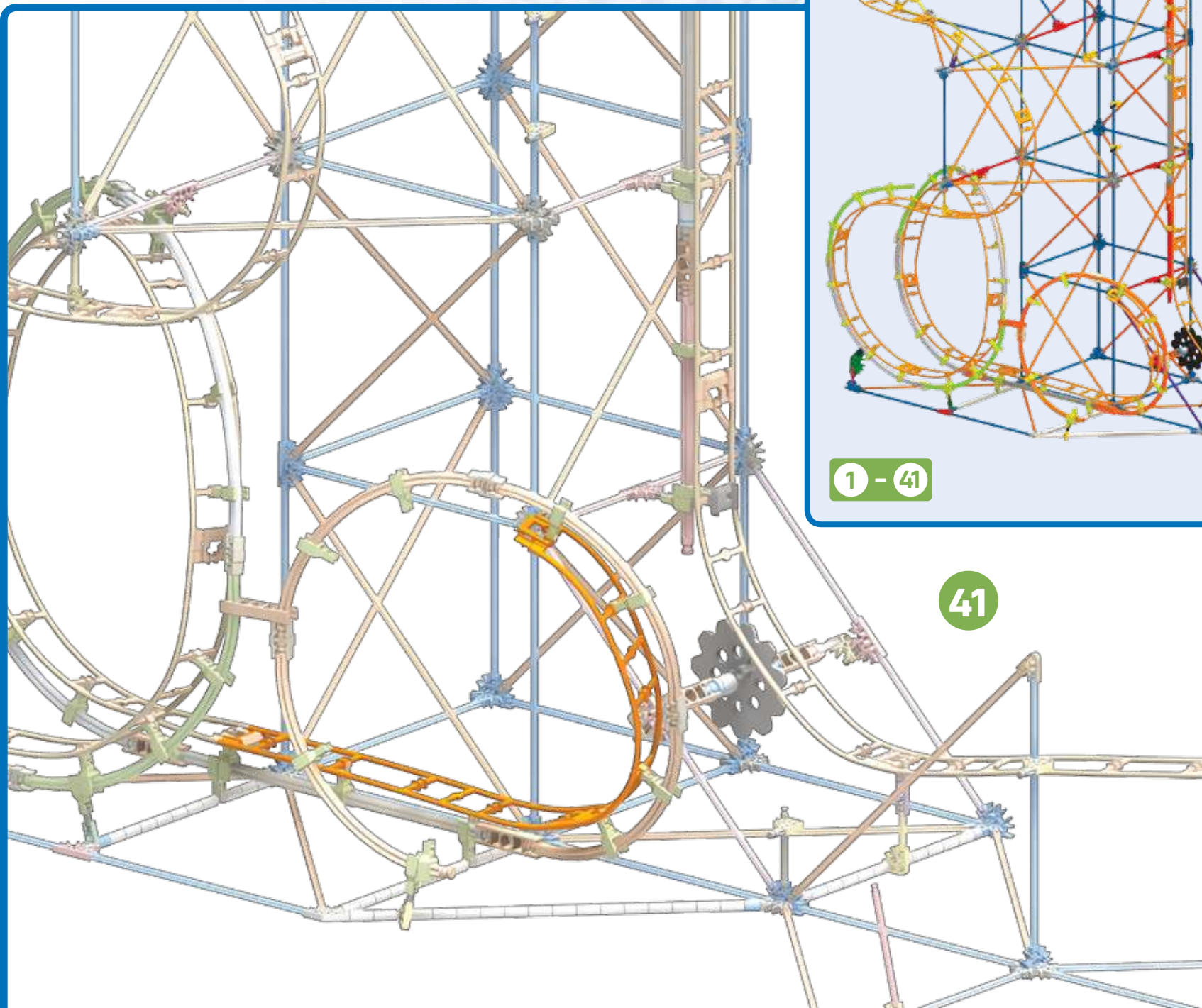
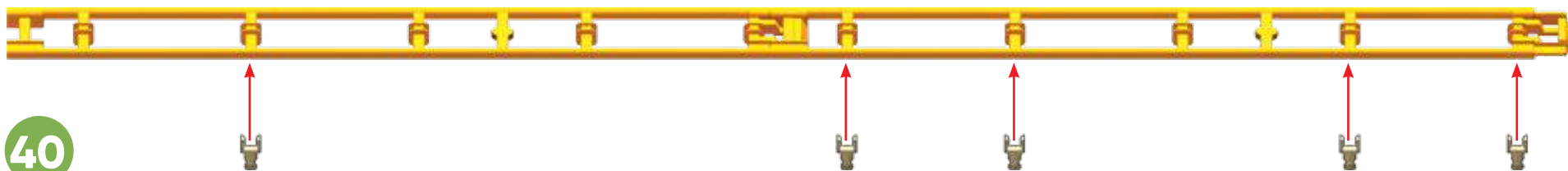

42

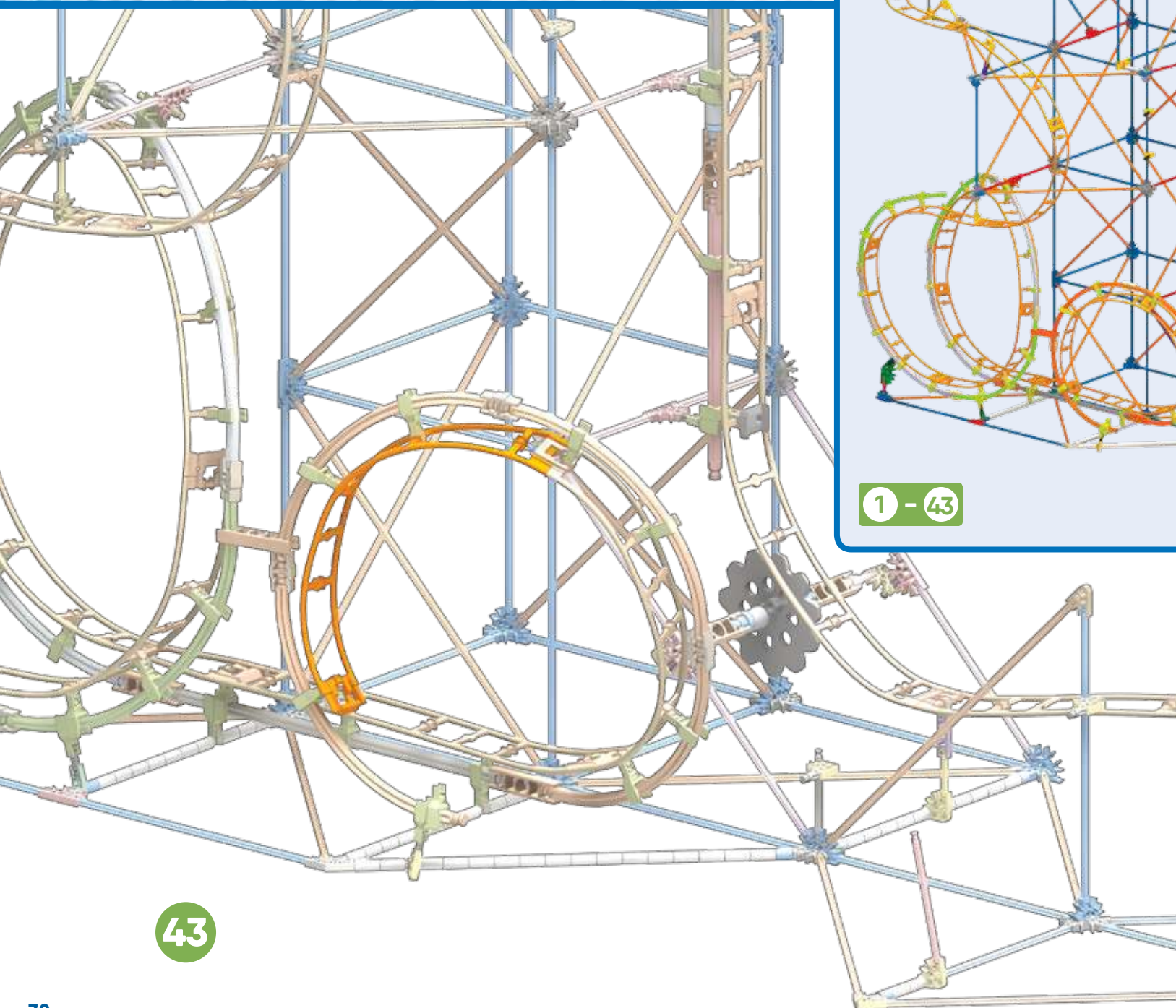
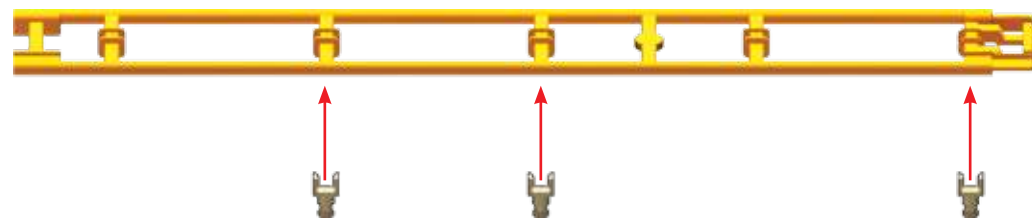

43

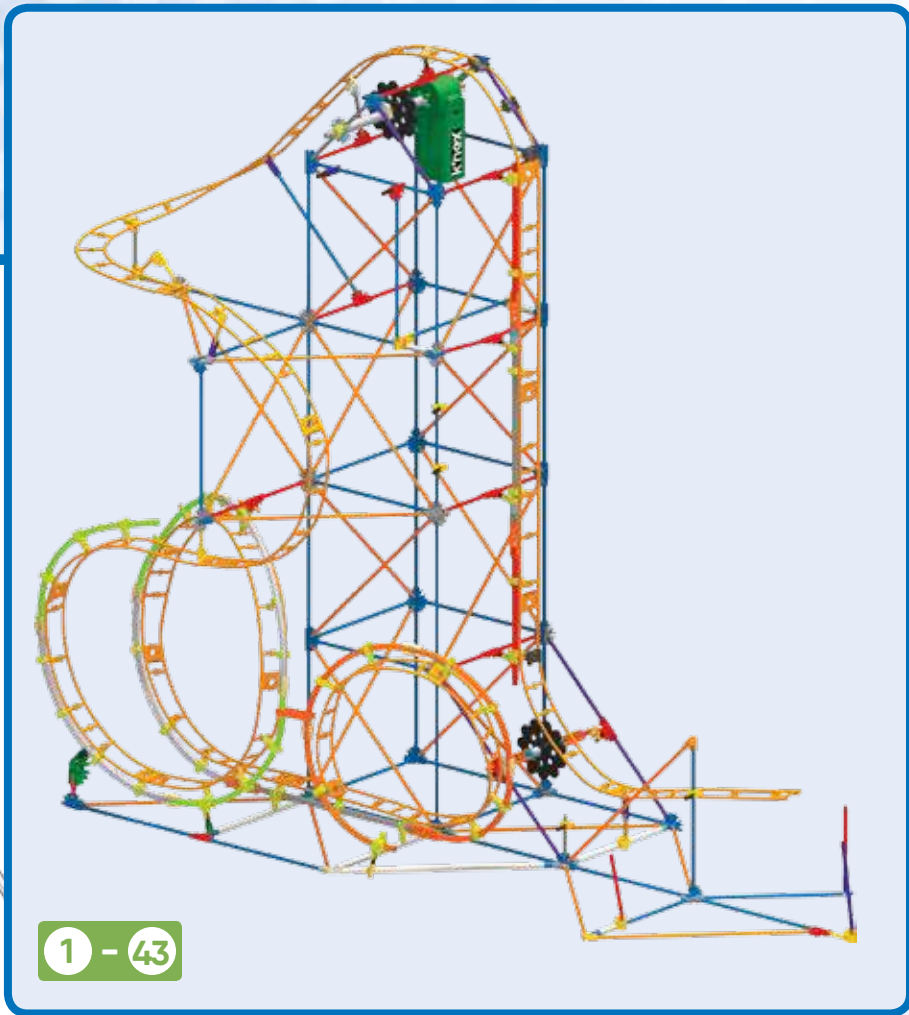

1 - 43



44

洞

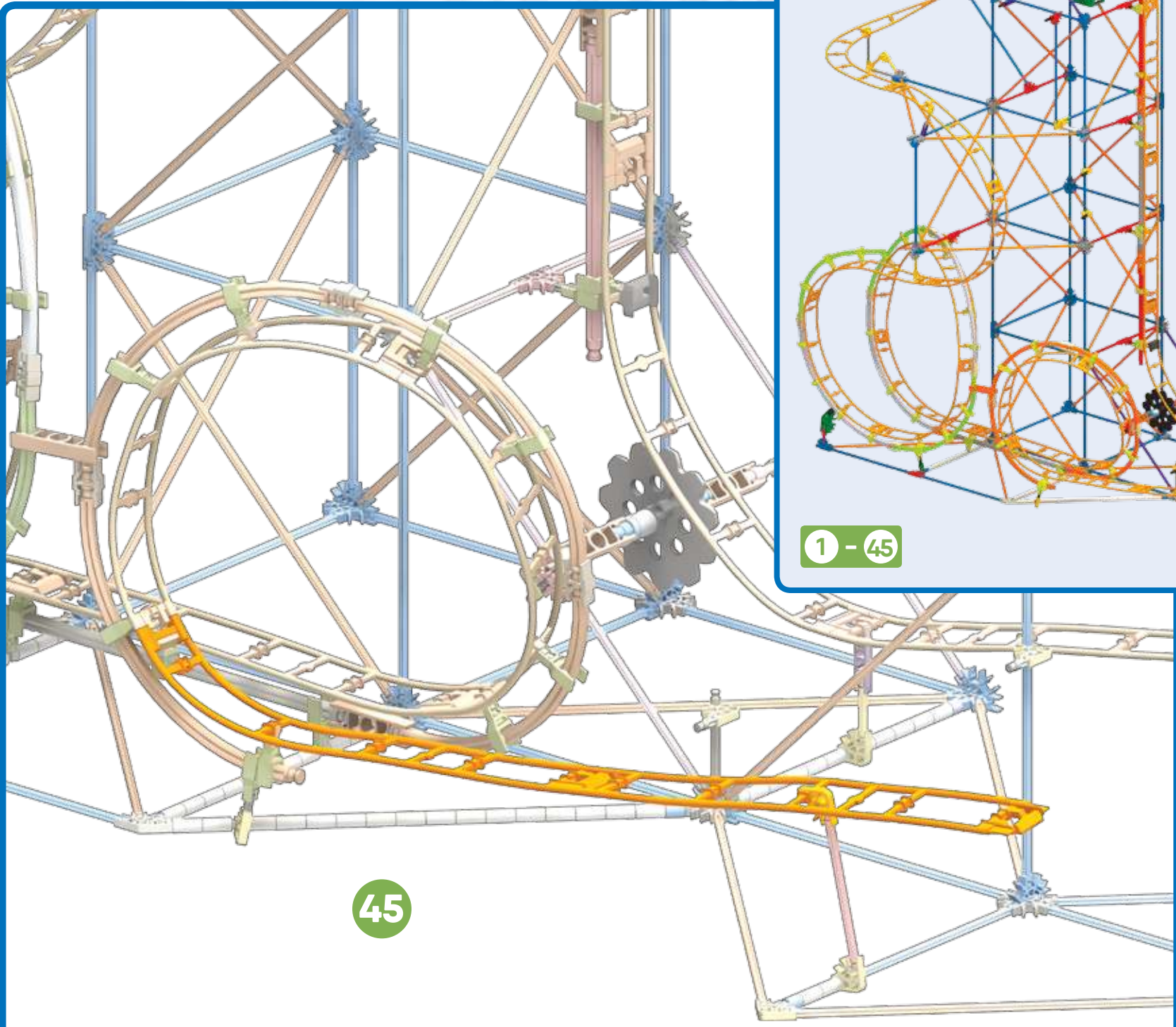

45



1 - 45

Apply Stickers
 Appechez des autocollants ^S



46

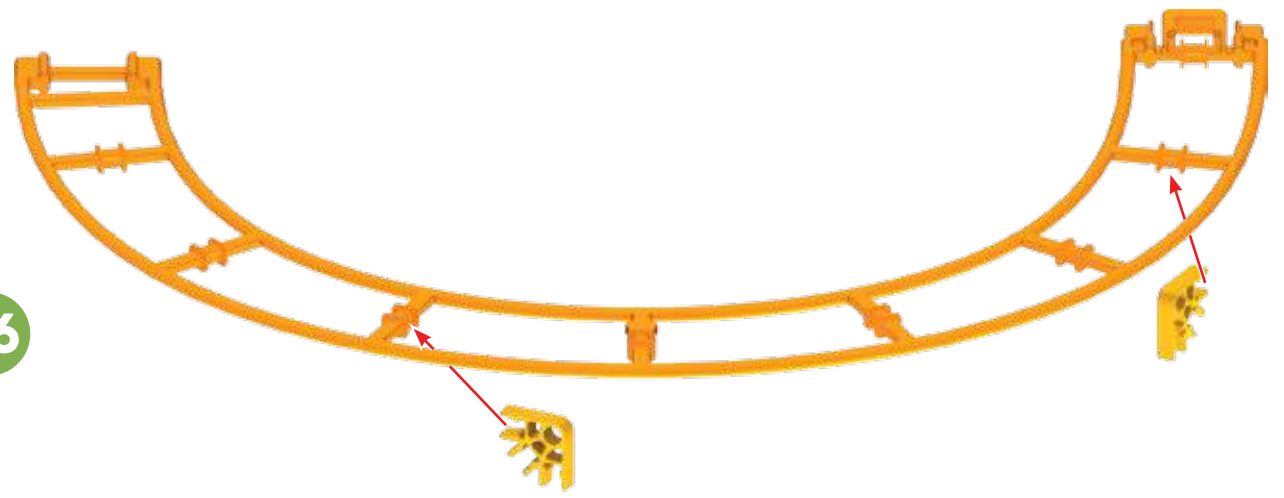

§(ES) Apliquar pegatinas
 (DE) Bringe die Aufkleber an
 (IT) Applicare gli adesivi
 (PT) Aplicar adesivos
 (NL) Stickers plakken

47

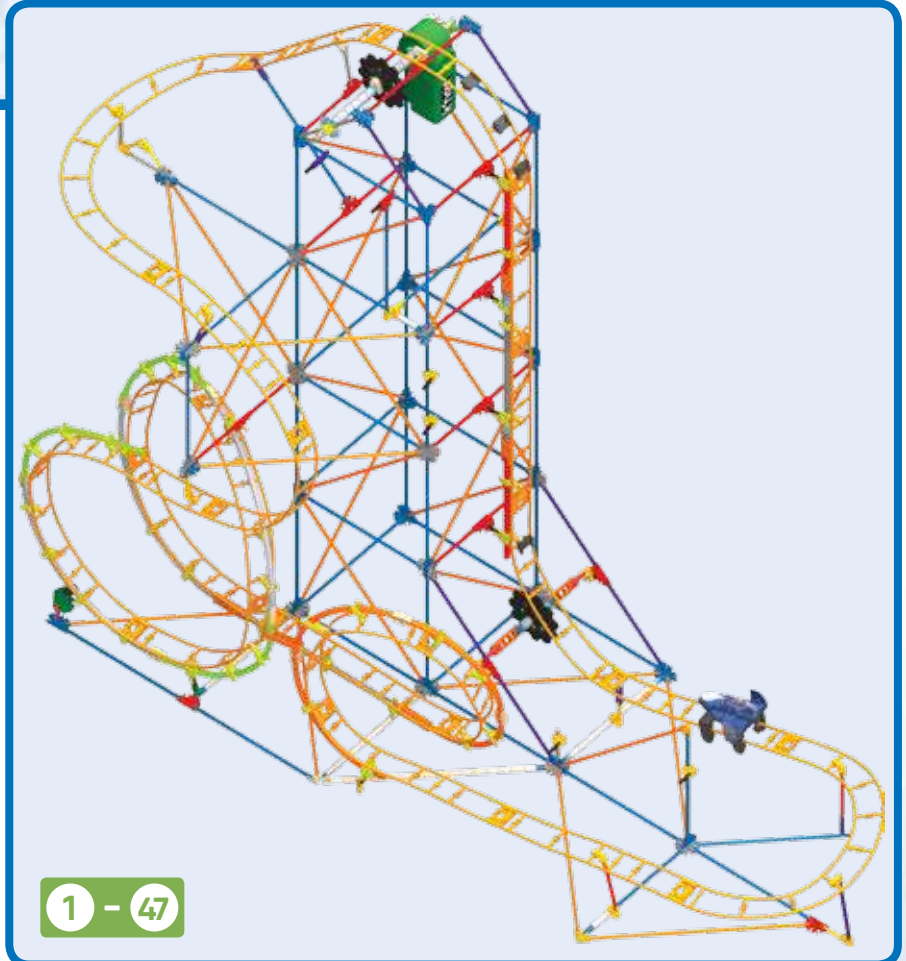
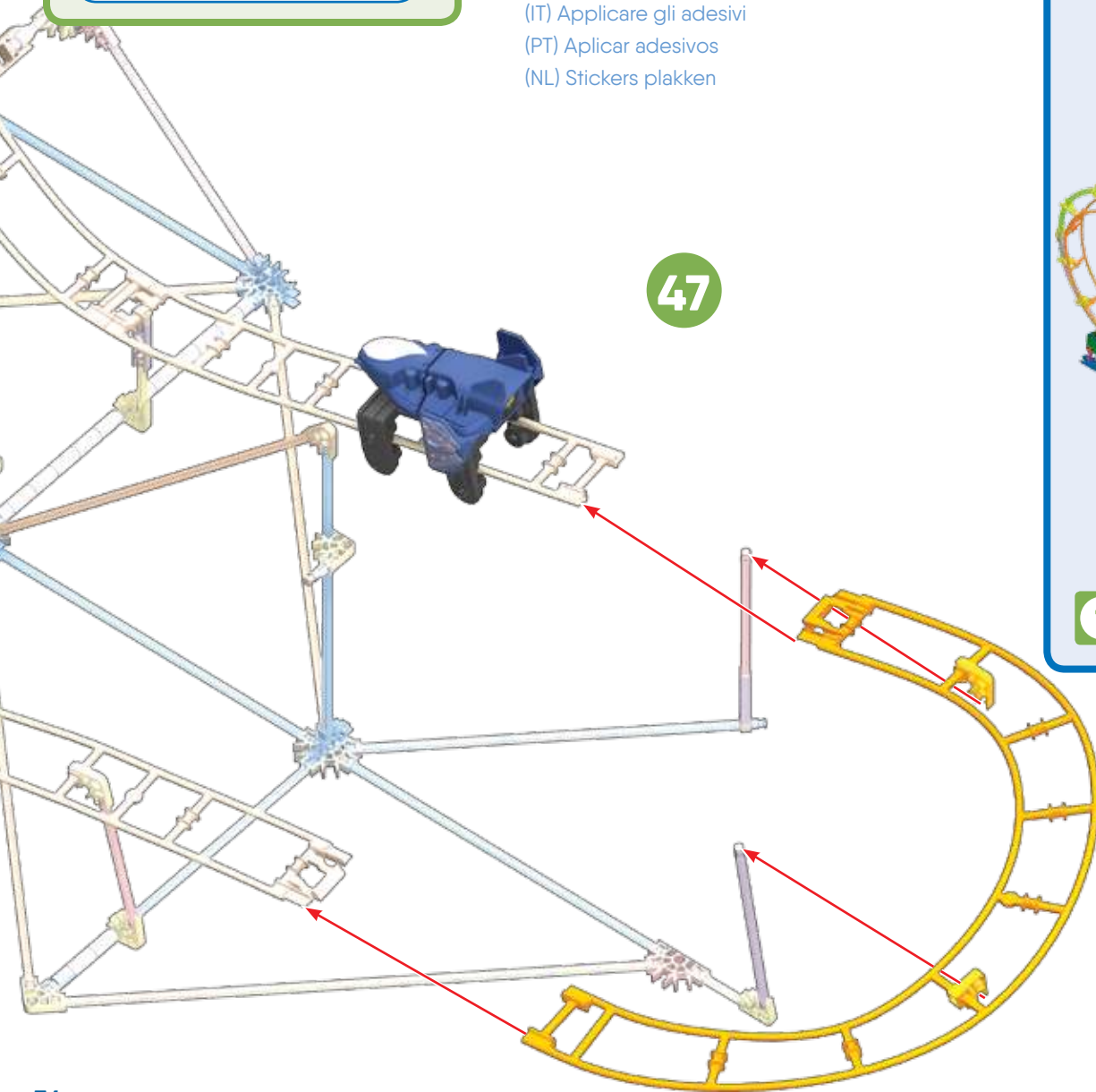

IMPORTANT: Attach all the chain links in the same direction.

IMPORTANT : Assure-toi de fixer tous les maillons de la chaîne dans le même sens.



48



x5

x1

50

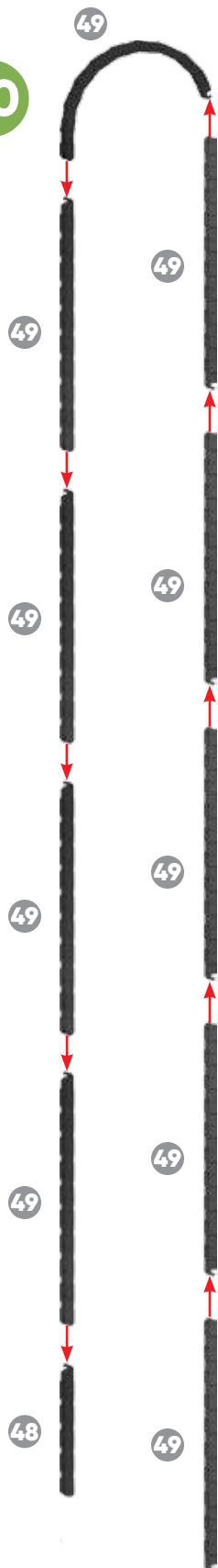

49



x10

x10

51

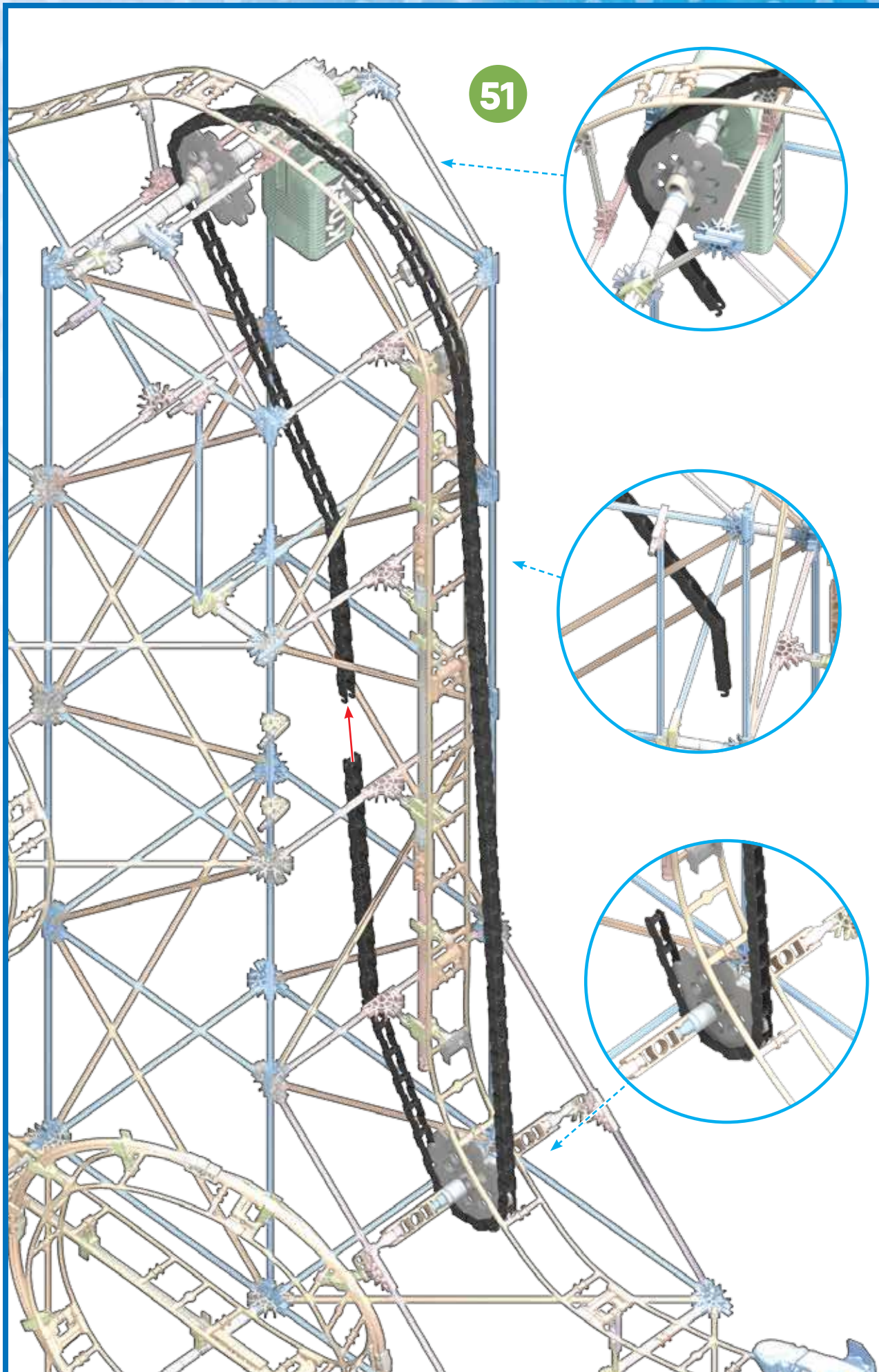

6 

52



53



54



MECHA STRIKE™

Roller Coaster Building Set

GREVE DE MECHA™

Montagnes Russes Jeu de Construction

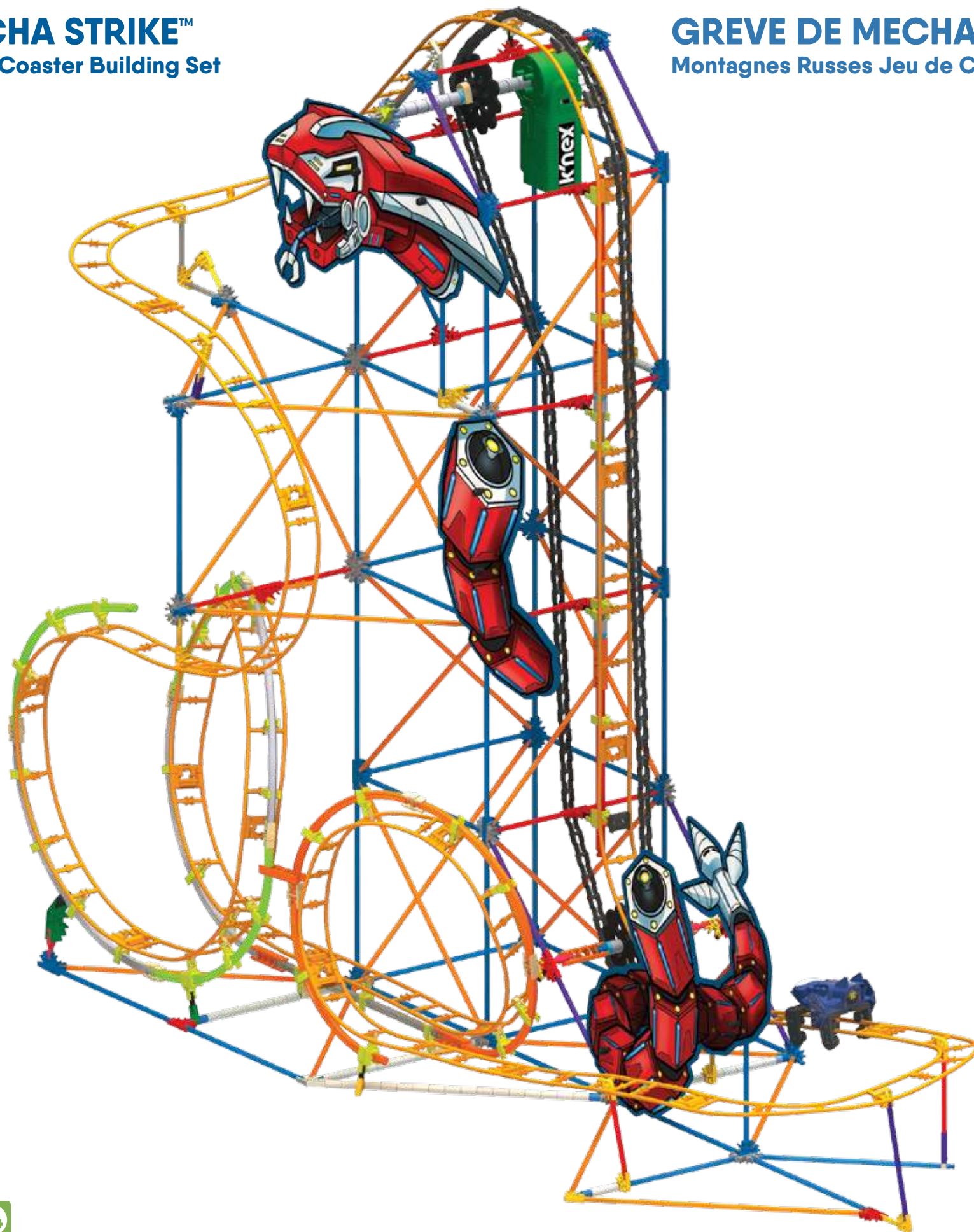

1 - 54

Guarde esta información importante para futuras referencias

ADVERTENCIA: PELIGRO DE ASFIXIA – Piezas pequeñas. No para niños menores de 3 años.

PRECAUCIÓN: Mantén el cabello, los dedos, la cara y la ropa alejada de las piezas móviles.

PRECAUCIÓN: Tenga cuidado de no inclinar el modelo. El modelo debe colocarse sobre una superficie plana y dura.

No obstruyas la pista con objetos o cualquier parte de tu cuerpo.

Información de la batería

Cómo insertar y quitar las pilas

Utilizar un pequeño destornillador principal Phillips para aflojar el tornillo y para quitar la cubierta de batería. Insertar 2 AA (LR6) baterías** frescas en el compartimiento de batería con la polaridad correcta (+/-). Instale las baterías antes de la construcción de modelo.

** No se incluyen

PRECAUCIÓN: Para evitar fugas en las pilas

- Inserte las pilas de acuerdo con los esquemas de polaridad (+/-).
- No mezcle diferentes tipos de pilas.
- No mezcle pilas alcalinas, estándar (carbón-zinc) o recargables.
- No mezcle pilas viejas con nuevas. Se debe usar solamente pilas del mismo tipo, o las que se recomiendan como equivalentes.
- Siempre retire las pilas débiles o gastadas del producto; no forme cortocircuito en los puntos de intercambio.
- Retire todas las pilas si el juguete no se usará por mucho tiempo.

Consejos importantes

- Se recomiendan las pilas alcalinas.
- No se recomiendan las pilas recargables.
- Retire las pilas recargables del juguete antes de cargarlas; éstas deben ser cargadas solamente bajo la supervisión de un adulto.
- No se debe recargar las pilas que no son recargables.
- Mantenga los componentes sin polvo; no sumerja ni use en agua.
- No deseche las pilas en el fuego ya que pueden tener fugas, explotar y causar lesiones personales.



El contenedor de basura indica que este producto no puede desecharse con la basura doméstica debido a la presencia de sustancias peligrosas. Para proteger la salud humana y el medio ambiente consultar con la agencia local para el consejo y las facilidades de reciclaje (2012/19/EU, solo Europa).

Básicos de Construcción

Empieza a construir

Para comenzar tu modelo, busca el 1 y sigue los números. Cada pieza tiene su propia forma y color. Simplemente mira los dibujos, busca las piezas correspondientes en tu juego y después conéctalas. Mientras construyes, trata de colocar tu modelo en la misma dirección que se muestra en las instrucciones. Los colores desteñidos muestran que esta sección ya está construida. Conecta las nuevas secciones en los lugares señalados por las flechas. Las nuevas piezas que agregues estarán en colores vivos.

(Página 3)

Conectores

Hay conectores azules y plateados con ranuras largas especiales. Se enganchan deslizándose como ves en los dibujos. Conecta estas piezas empujándolas hasta que oigas "clic".

Espaciadores

Hay lugares en tu modelo donde tendrás que agregar espaciadores. Asegúrate de cuéntalos con cuidado.

Cadena

Asegúrate de fijar todos los elementos de la cadena en la misma dirección.

Lista de Piezas

Antes de empezar con la construcción, asegúrate de comparar las piezas en tu conjunto con la lista de las piezas aquí. Si faltan algunas, llámanos o escríbenos siguiendo las instrucciones en la página trasera. Estamos aquí para ayudarte.

(Página 4)

CONSEJOS: Mientras construyes, trata de colocar tu modelo en la misma dirección que se muestra en las instrucciones.

(Página 23)

Sujeta las guías de cadena al lado superior de la pista. Sujeta los conectores en el lado inferior de la pista, exactamente como se muestra.

Empuja los conectores hacia adentro hasta que oigas un "clic".

(Página 24)

Siempre unirse a este extremo de la pista a la pieza primera pista anterior, a continuación, conecte el resto de la pista a la torre.

(Página 35)

IMPORTANTE: Asegúrate de fijar todos los elementos de la cadena en la misma dirección.

Informationen für später aufbewahren



ACHTUNG: ERSTICKUNGSGEFAHR – Kleinteile. Nicht geeignet für Kinder unter 3 Jahren.

VORSICHT: Haare, Finger, Gesicht und Kleidungsstücke nicht mit beweglichen Teilen in Berührung kommen lassen.

VORSICHT: Sei vorsichtig, das Modell nicht zu betreiben. Das Modell sollte auf eine flache und harte Oberfläche gestellt werden.

Die Schienen dürfen nicht blockiert oder mit dem Körper verdeckt werden.

Informationen zu den Batterien

Anweisungen zum Einlegen und Entfernen der Batterien

Einen kleinen Kreuzkopfschraubenzieher benutzen, um die Schraube zu lösen und die Batterieabdeckung zu entfernen. 2 frische AA (oder LR6) Batterien** in den Batterieraum mit der korrekten Polarität einsetzen (+/-). Batterien vor dem Bau der Modelle einsetzen.

** Nicht enthalten

VORSICHT: Um ein Auslaufen der Batterien zu vermeiden

- Beim Einlegen der Batterien auf die korrekte Polarität (+/-), wie dargestellt, achten.
- Keine Batterien unterschiedlichen Typs mischen.
- Keine alkaline Batterien, Standard-Batterien (Kohle-Zink) oder wiederaufladbare Batterien mischen.
- Keine alten und neuen Batterien mischen. Nur Batterien des gleichen Typs oder empfohlenen äquivalenten Typs verwenden.
- Leere oder verbrauchte Batterien aus dem Spielzeug entfernen; darauf achten, dass die Pole der Batterie nicht kurzgeschlossen werden.
- Wenn das Spielzeug längere Zeit nicht verwendet werden soll, alle Batterien entfernen.

Wichtige Tipps

- Alkaline Batterien werden empfohlen.
- Wiederaufladbare Batterien sind nicht empfohlen.
- Bei Verwendung von wiederaufladbaren Batterien müssen diese aus dem Spielzeug entfernt werden, bevor sie wieder aufgeladen werden; das Wiederaufladen darf nur unter Aufsicht eines Erwachsenen stattfinden.
- Nichtwiederaufladbare Batterien dürfen nicht wieder aufgeladen werden.
- Die Komponenten von Staub freihalten; nicht in Wasser tauchen.
- Zu entsorgende Batterien nicht ins Feuer werfen; sie können auslaufen oder explodieren und Körperverletzungen verursachen.



Der Abfallbehälter zeigt an, dass dieses Produkt aufgrund von Giftstoffen nicht im normalen Hausmüll entsorgt werden kann. Zum Schutz von Gesundheit und Umwelt kontaktiere bitte deine lokale Behörden für Recyclingtipps und -einrichtungen (2012/19/EU, nur Europa).

Grundlegende Bauanleitungen für K'NEX

Los geht's mit dem Bauen

Um mit dem Bauen deines Modells zu beginnen, suche die Nummer 1 und folge den laufenden Nummern. Jedes Teil hat seine eigene Form und Farbe. Schau dir einfach die Abbildungen an, such die Teile in deinem Bausatz, die so aussehen wie das, was du auf der Abbildung siehst und steck sie ineinander. Versuche, dein Modell beim Zusammenbauen so zu orientieren, dass es in die gleiche Richtung weist, wie es in den Anleitungen beschrieben und gezeigt wird. Blasser Farben weisen darauf hin, dass dieser Streckenabschnitt bereits zusammengebaut ist.

(Seite 3)

Verbindungsstücke

Blaue und silberfarbene Verbindungsstücke haben besonders lange Schlitz. Wie du auf der Abbildung sehen kannst, lassen sie sich ineinander schieben. Achte beim Aneinanderfügen dieser Teile darauf, dass du ein Klickgeräusch hörst. Erst dann sind die Teile fest miteinander verbunden.

Abstandsstücke

An manchen Stellen in deinem Modell musst du Abstandsstücke einbauen. Achte darauf, die richtige Anzahl von Abstandsstücken wie in der Anleitung gezeigt zu verwenden.

Kette

Achte darauf, alle Kettenglieder in der gleichen Richtung zu verbinden.

Teilleiste

Bevor du mit dem Bauen anfängst, solltest du prüfen ob die Teile in deinem Bausatz mit denen auf dieser Teilleiste übereinstimmen. Falls etwas fehlt, rufe uns an oder schreibe uns (siehe Rückseite). Wir sind für dich da!

(Seite 4)

TIPP: Versuche, dein Modell beim Zusammenbauen so zu orientieren, dass es in die gleiche Richtung weist, wie es in den Anleitungen beschrieben und gezeigt wird.

(Seite 23)

Maak de kettingdids vast bovenaan het spoor. Maak de koppelstukken vast aan de onderkant van het spoor precies zoals afgebeeld.

Druk de koppelstukken goed erin tot ze "klikken".

(Seite 24)

Immer beitreten dieses Ende der Strecke zum vorherigen Track Stück zuerst, dann treten der Rest der Strecke auf den Turm.

(Seite 35)

WICHTIGE: Achte darauf, alle Kettenglieder in der gleichen Richtung zu verbinden.

Conservare queste importanti informazioni per riferimento futuro



AVVISO: PERICOLO DI SOFFOCARE – Pezzi piccoli. Non adatto per bambini sotto 3 anni.

ATTENZIONE: Tenere i capelli, le dita, il viso e i vestiti lontano da tutte le parti in movimento.

ATTENZIONE: Fare attenzione a non inclinare il modello sopra. Modello deve essere collocato su una superficie piana e dura.

Non ostruire la pista con gli oggetti o qualsiasi parte del vostro corpo.

Informazioni sulle batterie

Come inserire e rimuovere le batterie

Utilizzare un piccolo cacciavite phillips per allentare le vite e per rimuovere la copertura di batteria. Inserire 2 AA (o LR6) batterie** fresche nello scompartimento di batteria con la polarità corretta (+/-). Installare le batterie prima di modelli di edifici.

** Non incluse

ATTENZIONE: Come evitare perdite delle batterie

- Inserire le batterie con la polarità corretta (+/-) come illustrato.
- Non mischiare tipi diversi di batterie.
- Non mischiare alcaline, standard (carbonio-zinco) e ricaricabili.
- Non mischiare insieme batterie nuove e vecchie. Usare sempre batterie raccomandate dello stesso tipo o di tipo equivalente.
- Rimuovere sempre batterie quasi scariche o completamente scariche dal prodotto; non causare corto circuito ai terminali di alimentazione.
- Non gettare le batterie nel fuoco, poiché potrebbero perdere o esplodere e causare lesioni.

Consigli importanti

- Si raccomanda l'uso di batterie alcaline.
- Non si raccomanda l'uso di batterie ricaricabili.
- Rimuovere le batterie ricaricabili dal giocattolo prima della carica: devono essere caricate solo sotto la supervisione di un adulto.
- Le batterie non ricaricabili non devono essere ricaricate.
- Mantenere i componenti privi di polvere; non immergere o usare in acqua.
- Rimuovere tutte le batterie se il giocattolo non verrà usato per un lungo periodo di tempo.



Il bidone della spazzatura indica che questo prodotto non si può buttare via con i rifiuti domestici a causa della presenza di sostanze pericolose. Per proteggere la salute umana e l'ambiente, devi controllare con la tua autorità locale per consigli e impianti di riciclaggio (2012/19/EU, solo in Europa).

Istruzioni di base per costruire con K'NEX

Comincia a costruire

Per iniziare il modello, cerca il numero 1 e segui i numeri. Ogni pezzo ha una sua forma e un suo colore. Guarda la figura, trova i pezzi corrispondenti nel set e mettili insieme. Cerca di tenere il modello nella stessa direzione della figura e in tal modo sarà più semplice attaccare i pezzi nei posti giusti. I colori spenti ti dicono che questa sezione è già stata costruita. Dovrai collegare la nuova sezione al punto indicato dalla punta della freccia.

(Pagina 3)

Connettori

È molto importante posizionare i connettori blu e argento in una specifica direzione. Presta molta attenzione alle istruzioni e posiziona i connettori orizzontalmente o verticalmente proprio come illustrato. Spingi con forza fino ad udire un clic.

Spaziatori

Ci sono punti nel tuo modello a cui dovrai aggiungere spaziatori. Accertati di contarli attentamente.

Catena

Accertati di attaccare tutti i collegamenti della catena nella stessa direzione.

Elenco delle parti

Prima di cominciare a costruire, accertati di confrontare le parti che sono nel tuo set con l'elenco delle parti qui. Se ne manca una chiamaci o scrivi usando le informazioni che sono nella retrocopertina. Noi siamo qui per aiutarci!

(Pagina 4)

SUGGERIMENTI: Orienta il tuo modello nella stessa direzione indicata nelle istruzioni.

(Pagina 23)

Attacca le guide a catena sulla parte superiore della rotaia. Collega i connettori sulla base della rotaia esattamente come illustrato.

Premi i connettori saldamente fino a che si fissano con uno scatto.

(Pagina 24)

Sempre partecipare a questo fine della traccia per traccia del pezzo precedente, poi collegare il resto della pista alla torre.

(Pagina 35)

IMPORTANTI: Accertati di attaccare tutti i collegamenti della catena nella stessa direzione.

Manter esta informação importante para referência futura

 **AVISO:** PERIGO DE SUFOCAÇÃO – Peças pequenas. Não se destina a crianças com menos de 3 anos de idade.

CUIDADO: Mantém o cabelo, os dedos, a cara e a roupa afastados de todas as peças móveis.

CUIDADO: Tenha cuidado para não derrubar o modelo. O modelo deve ser colocado sobre uma superfície plana e dura.

Não obstruir a trilha com objetos ou qualquer parte de seu corpo.

Informações sobre as pilhas

Como introduzir e remover baterias

Usar uma chave de fenda principal pequena de Phillips para afrouxar o parafuso e para remover a tampa de bateria. Introduzir 2 AA (ou LR6) baterias** frescas no compartimento de bateria com a polaridade correta (+/-). Instale baterias antes modelos de construção.

** Não estão incluídas

CUIDADO: Para evitar fugas das pilhas

- Introduza as pilhas com a polaridade correcta (+/-), conforme se mostra.
- Não misture tipos diferentes de pilhas.
- Não misture pilhas alcalinas, padrão (carbono-zinco) ou pilhas recarregáveis.
- Não combine pilhas usadas com pilhas novas. Apenas pilhas do mesmo tipo ou equivalentes ao tipo recomendado.
- Retire sempre as pilhas fracas ou gastas do produto; não provoque um curto-circuito nos terminais de alimentação.
- Retire todas as pilhas do brinquedo se não tencionar usá-lo durante um longo período de tempo.

Conselhos importantes

- Recomenda se o uso de pilhas alcalinas.
- Não se recomenda o uso de pilhas recarregáveis.
- Retire as pilhas recarregáveis do brinquedo antes de as carregar; estas pilhas devem ser recarregadas apenas sob vigilância de adultos.
- As pilhas não recarregáveis não devem ser carregadas.
- Mantenha os componentes livres de poeiras; não mergulhe em água nem use água.
- Não elimine as pilhas queimando-as; estas podem apresentar fugas ou explodir causando lesões.



O caixote do lixo indica que este produto não pode ser descartado junto com o lixo doméstico devido à presença de substâncias perigosas.

Para proteger a saúde humana e o meio ambiente verifique a sua autoridade local para reciclagem conselho e instalações (2012/19/EU, somente na Europa).

Pontos básicos para a construção K'NEX

Inicia a construção

Para começar o teu modelo, procura o 1 e segue os números. Cada peça tem a sua própria forma definida e cor. Basta simplesmente olhares para a ilustração, procurar as peças do teu jogo correspondentes às que estás a ver e, em seguida, conectar umas nas outras. Enquanto estás a montar as peças, tenta manter o teu modelo na mesma direcção, conforme mostrado na ilustração, para assim ligares as peças correctamente. As cores desbotadas indicam que esta secção já está montada. Passarás então a fazer a conexão da nova secção no local indicado pelas setas.

Conectores

É muito importante que posiciones os conectores azuis e cor de prateados numa direcção específica. Presta muita atenção às instruções e coloca estes conectores horizontal ou verticalmente, exactamente conforme se mostra nas ilustrações. Junta as partes simultaneamente e com firmeza até ouvires um "estalido".

Espaçadores

Existirão certos pontos no teu modelo que necessitam a colocação de espaçadores. Assegura-te que os contagem cuidadosamente.

Corrente

Assegura-te que prendes todos os elos da corrente seguindo a mesma direcção.

Lista de peças

Antes de iniciares a construção, certifica-te de que comparas as peças do teu conjunto com a lista das peças aqui. Se faltar alguma peça telefona ou escreve-nos usando as informações indicadas na contracapa. Estamos aqui para te ajudar!

(Página 4)

SUGESTÕES: Tenta fazer com que o teu modelo esteja virado exactamente na mesma direcção indicada nas instruções.

(Página 23)

Prende as Guias de Corrente ao topo da Pista. Liga os conectores à base da Pista exactamente como demonstrado.

Faz avançar os conectores firmemente até "encaixarem" com um estalido.

(Página 24)

Sempre aderir a este final da trilha para a peça faixa anterior primeiro, e depois conectar o restante da trilha para a torre.

(Página 35)

IMPORTANTES: Assegura-te que prendes todos os elos da corrente seguindo a mesma direcção.

Bewaar deze belangrijke informatie, zodat u deze in de toekomst opnieuw kunt raadplegen



WAARSCHUWING: INSLIKKINGSGEVAAR – Kleine onderdelen.

Niet geschikt voor kinderen jonger dan 3 jaar.

OPGEPAST: Houd handen, haar, gezicht en kleding uit de buurt van bewegende onderdelen.

OPGEPAST: Zorg ervoor dat het model niet te kantelen. Model moet op een vlak en hard oppervlak geplaatst.

Het spoor niet versperren met objecten of met een deel van je lichaam.

Informatie over Batterijen

Batterijen plaatsen en verwijderen

Gebruik een kleine kruiskopschroevendraaier om de schroef van het klepje los te draaien. Plaats 2 nieuwe AA-batterijen** (LR6) in het batterijvak en let daarbij op de polariteit (+/-), zoals hier wordt getoond. Plaats de batterijen voordat je een model bouwt.

** Niet inbegrepen

WAARSCHUWING: Voorkom lekkende batterijen

- Let op de polariteit bij het plaatsen van batterijen (+/-), zoals wordt getoond.
- Gebruik geen verschillende typen batterijen samen.
- Gebruik geen alkaline, gewone (koolstof-zink) of oplaadbare batterijen samen.

- Gebruik geen nieuwe en gebruikte batterijen samen. Gebruik uitsluitend batterijen van het aanbevolen type of van een gelijkwaardig type.
- Verwijder lege batterijen uit het speelgoed. Vermijd kortsluiting.
- Verwijder de batterijen uit het speelgoed als het langere tijd niet wordt gebruikt.

Belangrijke tips

- Alkalinebatterijen worden aanbevolen.
- Oplaadbare batterijen worden niet aanbevolen.
- Verwijder oplaadbare batterijen voordat u ze oplaadt. Het opladen mag uitsluitend gebeuren onder toezicht van een volwassene.
- Niet-oplaadbare batterijen mogen niet worden opgeladen.
- Houd de onderdelen stofvrij. Niet in water dompelen of gebruiken.
- Gooi batterijen niet in het vuur. Ze kunnen lekken of exploderen en schade veroorzaken.



Het pictogram van een verrijdbare vuilnisbak geeft weer dat dit product niet samen met het gewone huis-, tuin- en keukenafval mag worden weggegooid, omdat het gevaarlijke substanties bevat.

Bescherm gezondheid en milieu en vraag advies aan de plaatselijke afvalverwerking-sdienst over hoe en waar u producten kunt recyclen (2012/19/EU, alleen Europa).

Basisstappen voor K'NEX bouwen

Begin te bouwen

Om met je model te beginnen, vind eerst het nummer 1 en volg de nummers. Elk stuk heeft zijn eigen vorm en kleur. Kijk gewoonweg naar de afbeeldingen, vind de overeenstemmende stukken terug in je geheel en maak ze aan mekaar vast. Tracht je model in dezelfde richting te plaatsen als de aanwijzingen terwijl je bouwt en monteert. De vervaagde kleuren duiden aan dat dit deel reeds is opgebouwd. Gelieve het nieuwe deel vast te koppelen op de plaats aangeduid door de pijlen.

(Bladzijde 3)

Verbindingsstukken

Je kunt deze speciale verbindingstukken in elkaar steken. Duw ze stevig tegen elkaar aan tot je een 'klik' hoort. Let goed op de instructies en plaats ze horizontaal en verticaal, precies zoals wordt getoond.

Afstandhouders

Op bepaalde plekken van je model moet je afstandhouders gebruiken. Zorg dat je het juiste aantal afstandhouders gebruikt, zoals wordt getoond in de instructies.

Keten

Maak zeker dat alle ketenschakels vastgemaakt worden in dezelfde richting.

Lijst met onderdelen

Controleer aan de hand van deze lijst of je set alle onderdelen bevat voordat je begint te bouwen. Als er een onderdeel ontbreekt, bel of schrijf ons dan. Je vindt onze gegevens op de achterkant. We helpen je graag!

(Bladzijde 4)

TIP: Tracht je model in dezelfde richting te plaatsen als de aanwijzingen terwijl je bouwt en monteert.

(Bladzijde 23)

Maak de kettingsdissen vast bovenaan het spoor. Maak de koppelstukken vast aan de onderkant van het spoor precies zoals afgebeeld. Druk de koppelstukken goed erin tot ze "klikken".

(Bladzijde 24)

Altijd deelnemen aan deze eind van het spoor naar de vorige track stuk eerst, dan komen de rest van de track naar de toren.

(Bladzijde 35)

BELANGRIJKE: Maak zeker dat alle ketenschakels vastgemaakt worden in dezelfde richting.



MECHA STRIKE™
Roller Coaster Building Set
GREVE DE MECHA™
Montagnes Russes
Jeu de Construction

knex.com

@knexbrands

facebook.com/knexus



SCIENCE/SCIENCE
TECHNOLOGY/TECHNOLOGIE
ENGINEERING/INGÉNIERIE
ART & DESIGN/CONCEPTION & D'ART
MATH/MATHÉMATIQUES*

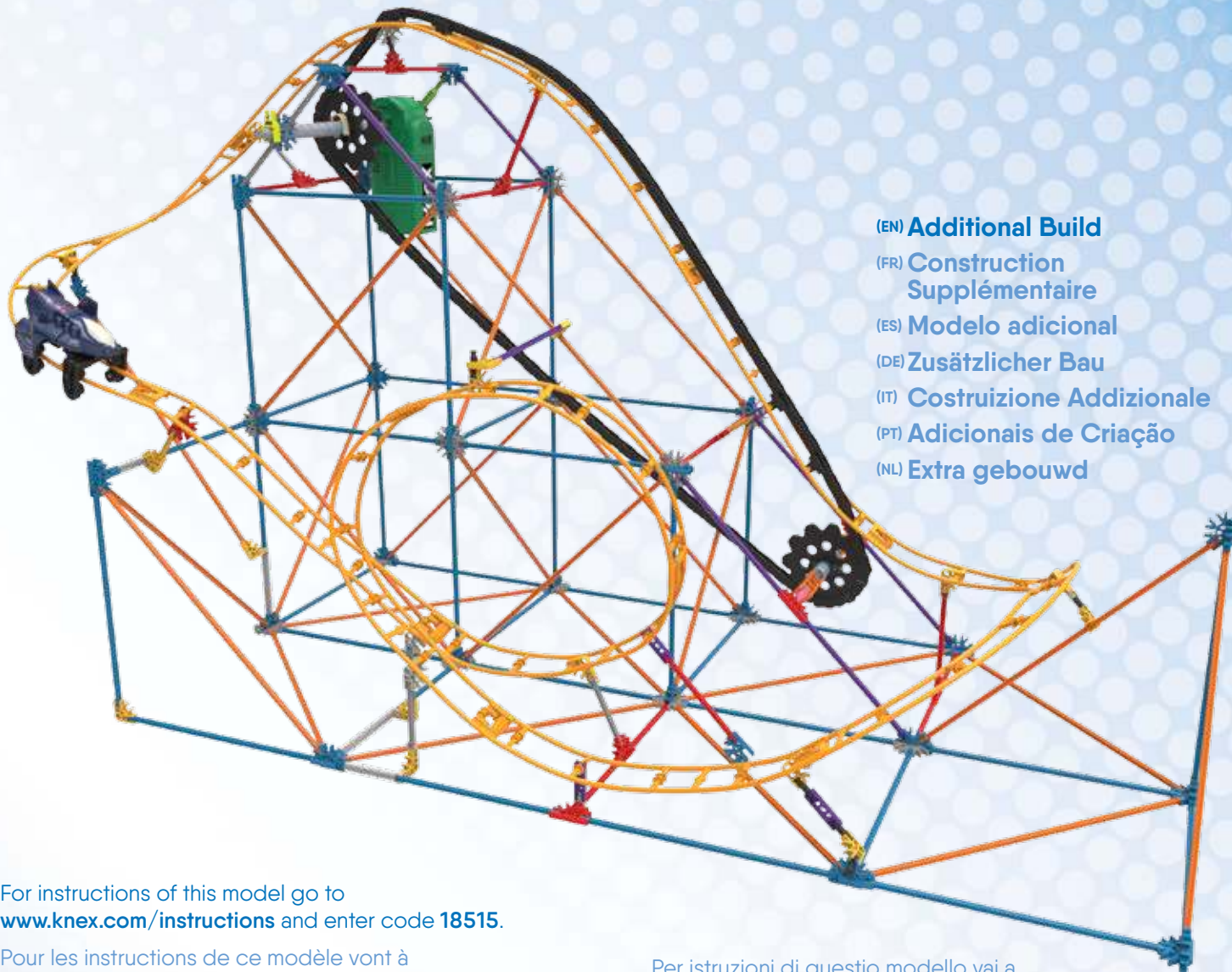

(EN) **Additional Build**

(FR) **Construction Supplémentaire**

(ES) **Modelo adicional**

(DE) **Zusätzlicher Bau**

(IT) **Costruzione Addizionale**

(PT) **Adicionais de Criação**

(NL) **Extra gebouwd**



Download Our App

Téléchargez notre application

Descargue nuestra aplicación

Lade unser App

Scarica il nostro App

Faça o download do nosso aplicativo

Download onze app

§ Juego inspirado
Inspiriertes Spiel
Ha ispirato il gioco
Inspirou o jogo
Geïnspireerd spel

Ciencia/Wissenschaft/
Scienza/Ciência/Wetenschap
Tecnología/Technologie/
Tecnologia/Tecnologia/
Technologie
Ingeniería/Ingenieurwesen/
Ingegneria/Engenharia/
Bouwkunde
Arte Y Diseño/Kunstdesign/
Arte E Design/Design de arte/
kunst En Ontwerp
Matemáticas/Mathematik/
Matematica/Matemática/
Wiskunde

[1] Motore

For instructions of this model go to www.knexus.com/instructions and enter code **18515**.

Pour les instructions de ce modèle vont à www.knexus.com/instructions et entrez dans le code **18515**.

Para obtener instrucciones de este modelo vaya a www.knexus.com/instructions y introducir el código **18515**.

Für Anweisungen dieses Modell gehen sie zu www.knexus.com/instructions und geben sie Code **18515** ein.

Per istruzioni di questo modello vai a www.knexus.com/instructions e inserire il codice **18515**.

Para obter instruções este modelo vá em www.knexus.com/instructions e digite o código **18515**.

Voor instructies van dit model naar www.knexus.com/instructions en vul de code **18515**.

©2017 K'NEX Limited Partnership Group, P.O. Box 700, Hatfield, PA 19440-0700; 1-800-KID-KNEX (USA/Canada/États-Unis/EE.UU.); email@knexus.com; knexus.com. K'NEX UK Ltd, 200 Brook Drive, Green Park, Reading, RG6 2UB England; K'NEX France, 24 rue du Quatre Septembre, 75002 Paris, France. For customers outside the USA/Canada please contact your local distributor at www.knexus.com/distributors.

(FR) Pour les clients en dehors du Canada et des États-Unis, veuillez contacter votre distributeur local que vous pouvez trouver sur www.knexus.com/distributors.

(ES) El cliente que no vive en EE.UU./Canadá se pone en contacto con el distribuidor local. Encuentre la información para el distribuidor local en www.knexus.com/distributors.

(EN) K'NEX is a registered trademark and Thrills Rides, Mecha Strike, and Steamagination are trademarks of K'NEX Limited Partnership Group.

(FR) K'NEX est une marque déposée et Thrill Rides, Mecha Strike, et Steamagination sont une marque de K'NEX Limited Partnership Group.

(ES) K'NEX es una marca registrada y Thrill Rides, Mecha Strike, y Steamagination son marcas de K'NEX Limited Partnership Group.

(EN) Product & colors may vary. Most models can be built one at a time.

(FR) Le produit et ses couleurs peuvent varier. Les différents modèles ne peuvent être construits qu'un par un.

(ES) El producto y los colores pueden variar. La mayoría de los modelos se pueden construir uno a la vez.

(DE) Produkte und Farben können abweichen. Die meisten Modelle können immer nur einzeln gebaut werden.

(IT) Prodotti e colori possono differire. La maggior parte dei modelli si può costruire autonomamente. Istruzioni accluse.

(PT) O produto e as cores podem variar. A maioria dos modelos pode ser montado um de cada vez.

(NL) Product en kleuren kunnen variëren. De meeste modellen kunnen uitsluitend een voor een worden gebouwd.

118515-V1-4/17

