

FYSIC

FX-2800

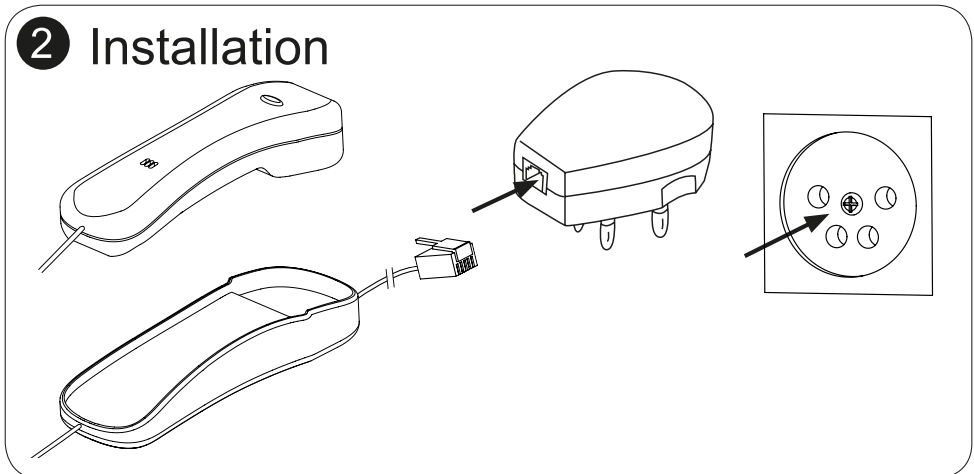

3 Ringer volume

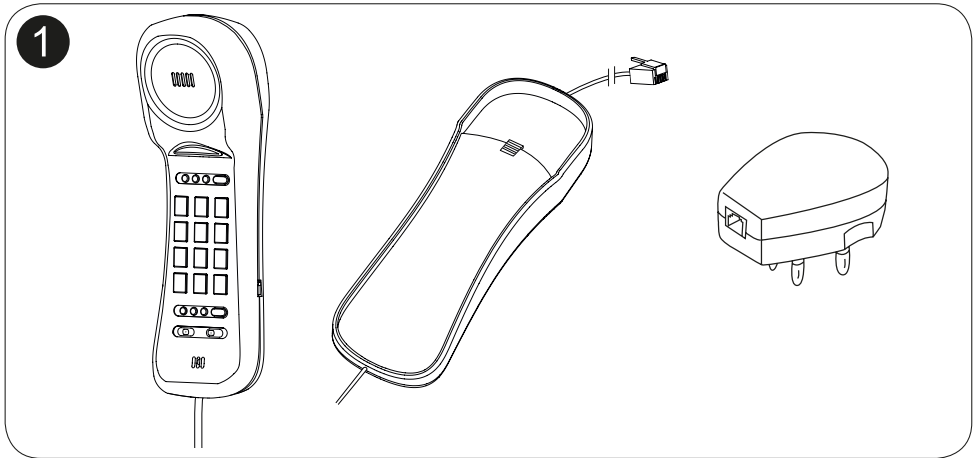
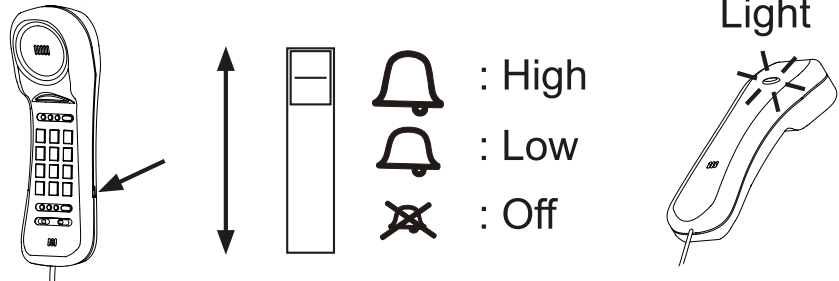

4 Handset volume control

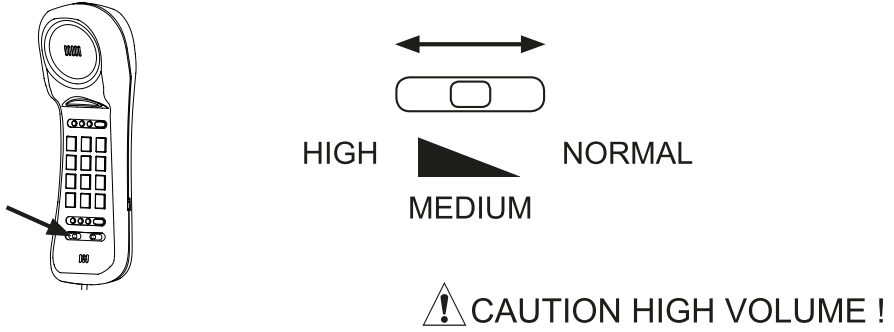

5 Place caution sticker

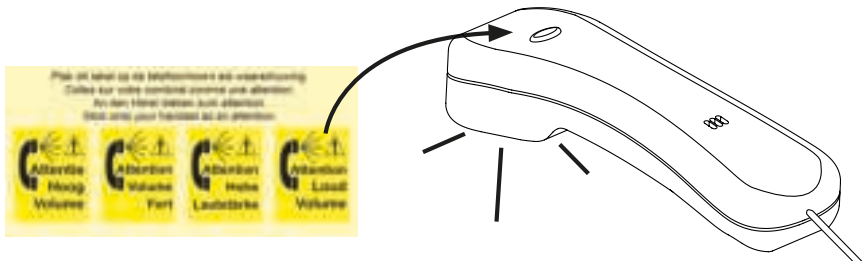

6 Tone setting

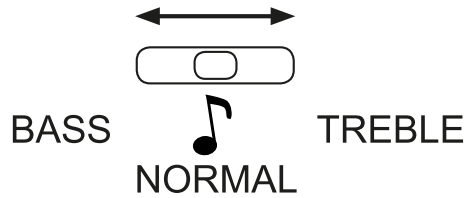
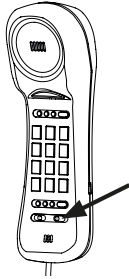

7 Dial

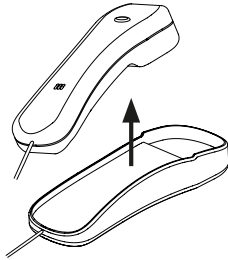

dial phone
number



8 Dial last number

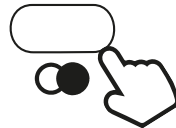
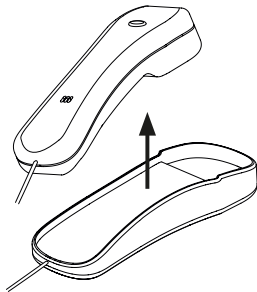

9 Store phone number

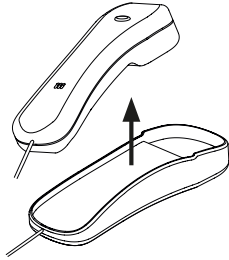

input
phone
number



select memory
button

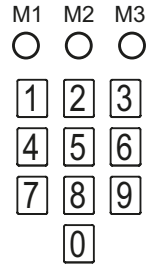

10 Dial from memory

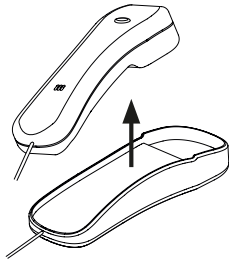

M1 M2 M3

○ ○ ○

dial
memory
button

OR

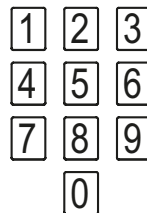

dial
memory
button

11 Wall mount

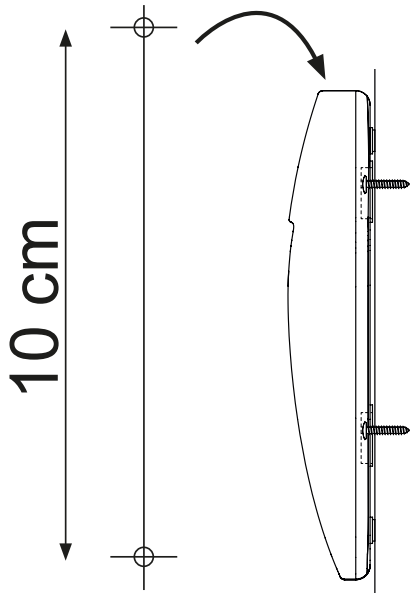

12 Turn clip

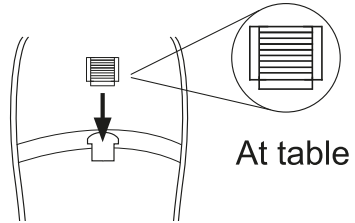

At table

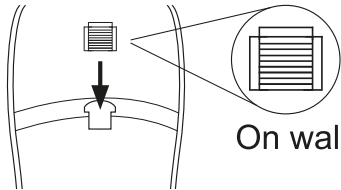

On wall

13

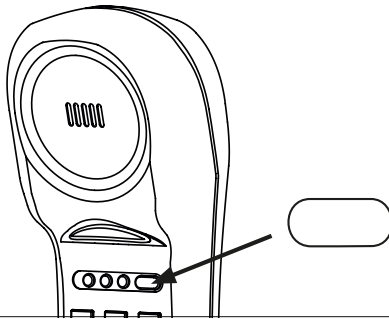

- Geen functie
- Pas de fonction
- Keine Funktion
- No function



R

NL Met de R-toets (ook wel FLASH genoemd) verbreekt u heel kort de telefoonverbinding; deze korte onderbreking wordt bij sommige huis- of kantoor centrales gebruikt om gesprekken door te verbinden; bij openbare centrales wordt deze toets gebruikt voor telecomfuncties, zoals voor het aannemen van een WisselGesprek.

FR Le bouton R (également appelé FLASH) est utilisé pour brièvement interrompre la connexion du téléphone; cette brève interruption est utilisée par certaines armoires électriques de maison ou de bureau pour transférer les appels; les armoires électriques publiques utilisent ce bouton pour des fonctions de télécom, tel que la mise en attente.

DE Die R-Taste (auch FLASH-Taste genannt) wird verwendet, um die Telefonverbindung kurzzeitig zu unterbrechen; diese kurze Unterbrechung wird von einigen Heim- oder Bürotelefonzentralen für Rufumleitung benutzt; öffentliche Telefonzentralen verwenden diese Taste für Telekommunikationsfunktionen, wie z.B. Anklopfen.

EN The R button (also called FLASH) is used to briefly interrupt the telephone connection; this brief interruption is used by some home or office switchboards for call forwarding; public switchboards use this button for telecom functions, such call waiting.



NL De toetsen * en # zijn toetsen die met name gebruikt worden bij telebankieren.

FR Les boutons * et # sont principalement utilisés pour du télé-banquing.

DE * und # sind Tasten, die hauptsächlich für Telebanking benutzt werden.

EN The * and # are buttons mainly used for tele-banking.

Hesdo bv.
Azielaan 12, 5232 BA
's-Hertogenbosch
The Netherlands

www.fysic.com



v1.0