

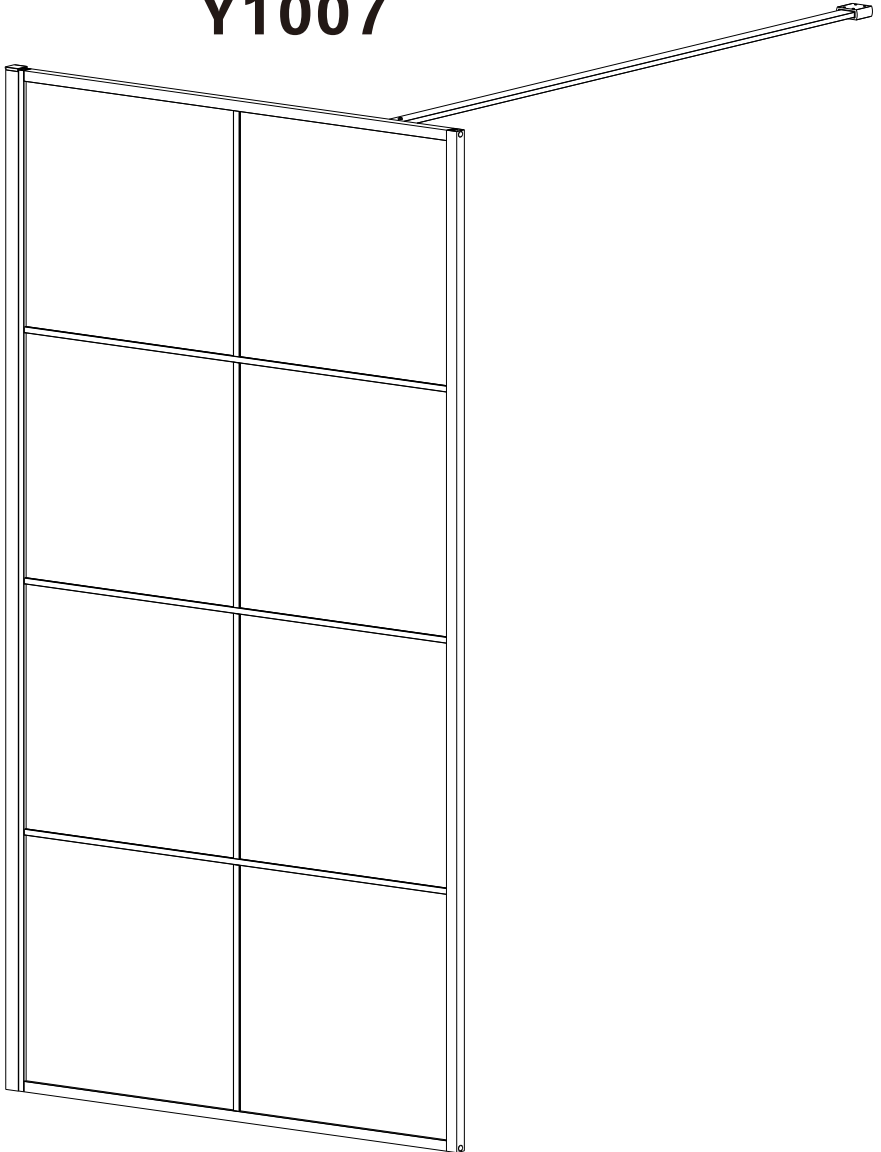

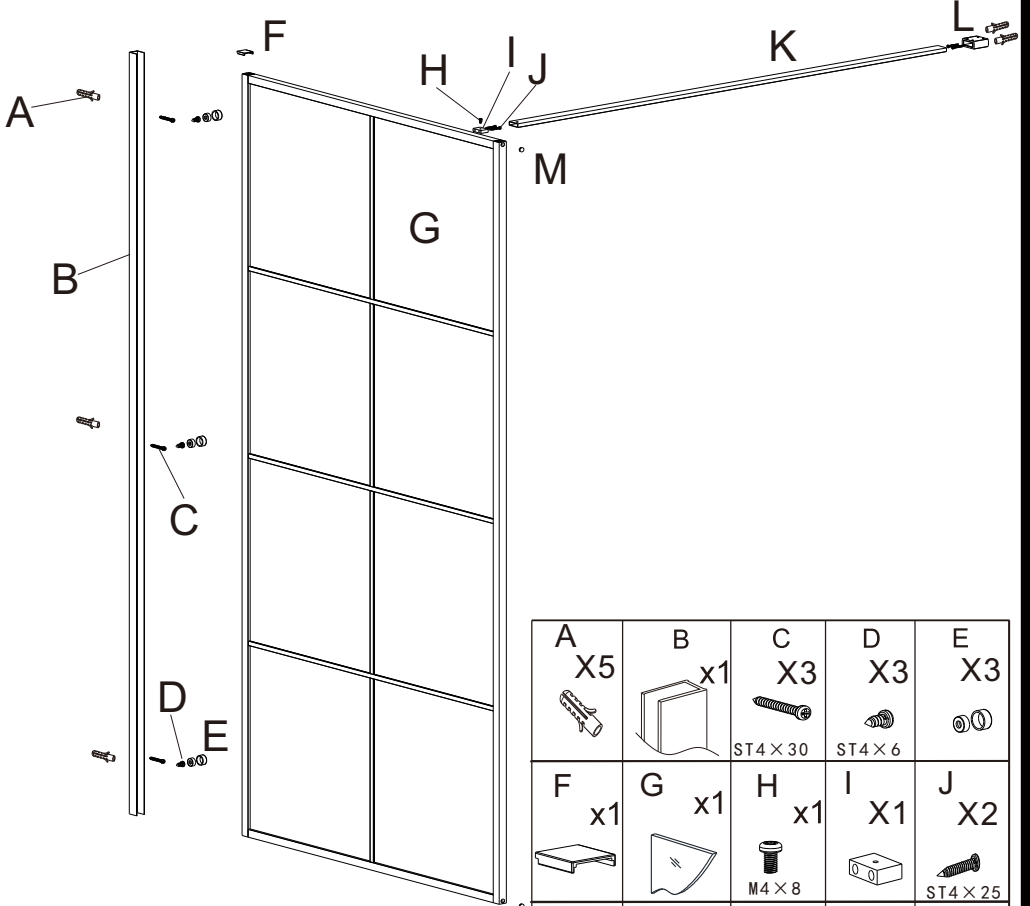













Y1007





A X5 	B x1 	C X3  <small>ST4 × 30</small>	D X3  <small>ST4 × 6</small>	E X3 
F x1 	G x1 	H x1  <small>M4 × 8</small>	I X1 	J X2  <small>ST4 × 25</small>
K x1 	L x1 	M X2 		

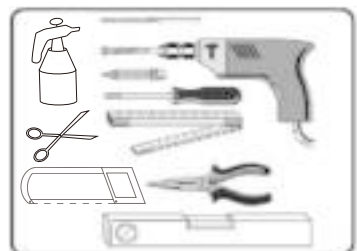
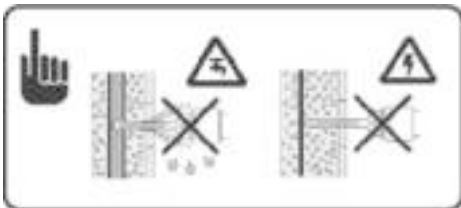

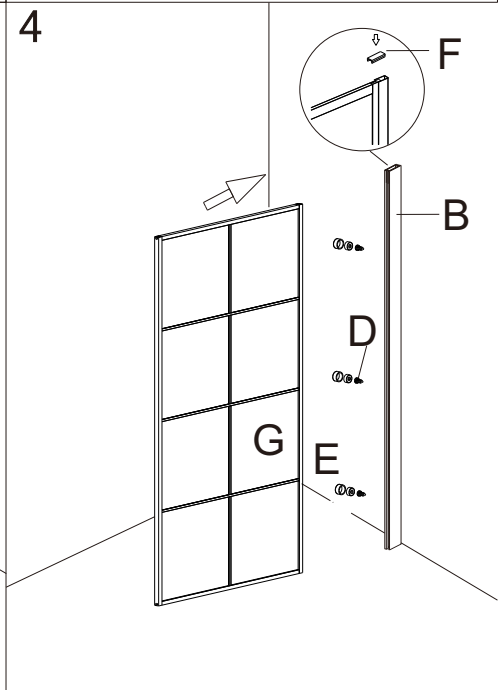
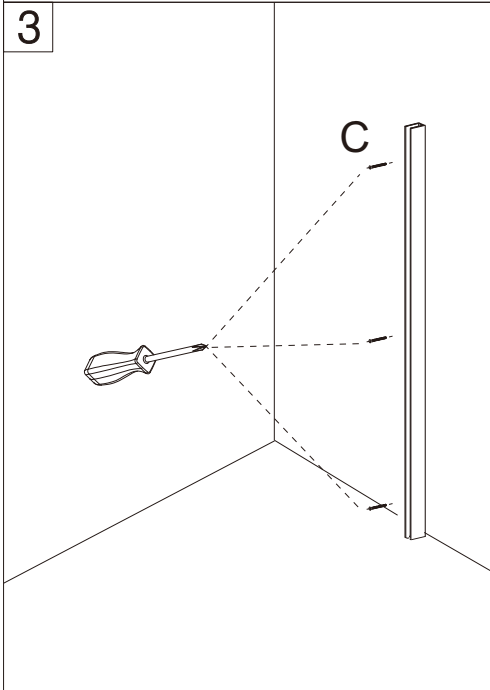
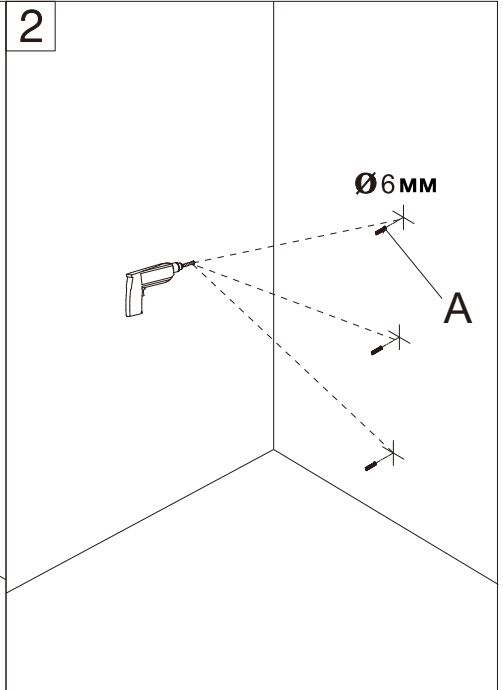
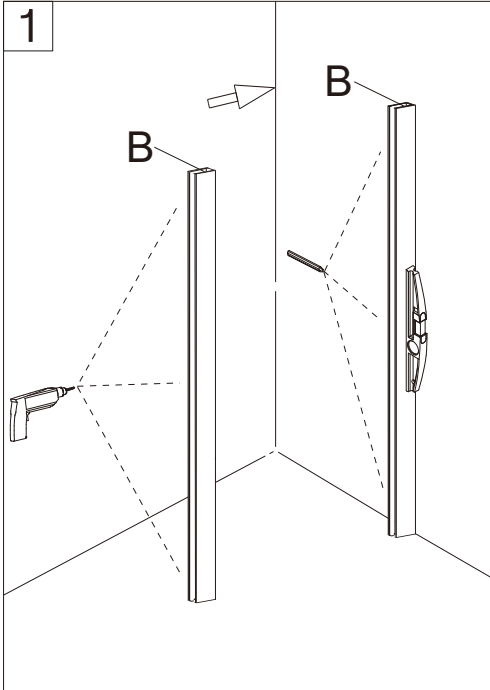



5

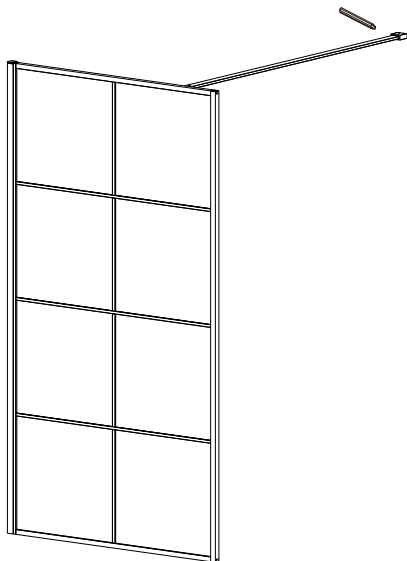

6

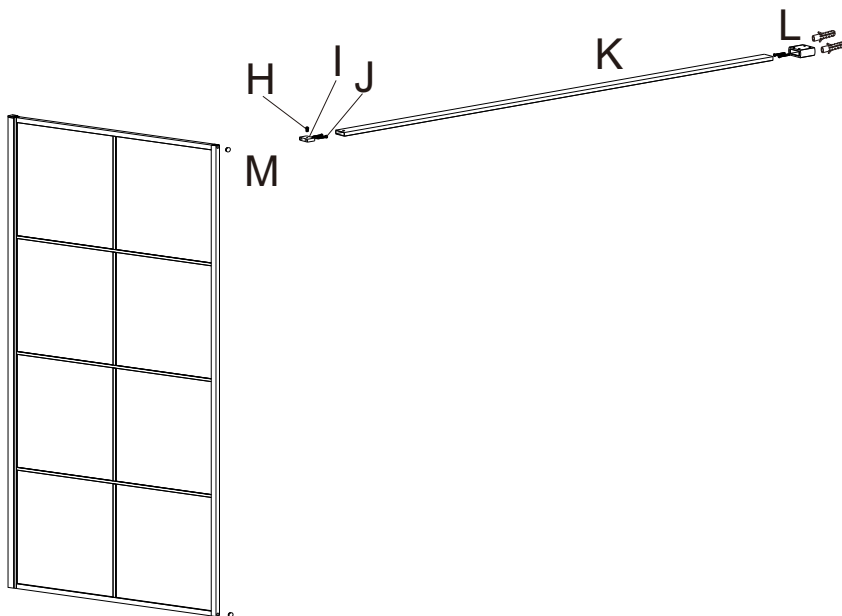



7

