

The use of any electrical appliance requires the following common sense safety rules. Please read these instructions carefully before using the product.

This appliance can be used by children aged from 8 years and above if they have been given supervision or instruction concerning the use of the appliance in a safe way and understand the hazards involved. Cleaning and user maintenance shall not be made by children unless they are older than 8 years and supervised. Keep the appliance and its cord out of reach of children aged less than 8 years.

Children shall not play with the appliance.

Appliances can be used by persons with reduced physical, sensory or mental capabilities or lack of experience and knowledge if they have been given supervision or instruction concerning use of the appliance in a safe way and understand the hazards involved.

If the mains cable is damaged, it must be replaced by the manufacturer, it's service agent or similarly qualified person in order to avoid a hazard.

WARNING: Do not open the lid whilst the water is boiling.

This appliance is intended to be used in household and similar applications such as: farm houses, by clients in hotels, motels and other residential type environments, and bed and breakfast type environments. It is not suitable for use in staff kitchen areas in shops, offices and other working environments.

Always locate your appliance away from the edge of the worktop.

Ensure that the appliance is used on a firm, flat surface.

Do not use the appliance outdoors or near water.

WARNING: Do not place the appliance onto a metal tray or metal surface whilst in use.

Do not let the mains cable hang over the edge of the worktop where a child could reach it.

Do not let the mains cable run across an open space e.g. between a low socket and a table.

Do not let the mains cable run across a cooker or other hot area which might damage the cable.

The mains cable should reach from the socket to the base unit without straining the connections.

Always keep the top of the cordless base dry, especially around the connection area, disconnect the power supply before drying. Allow to dry thoroughly before reconnection to the power supply.

Do not fill above the MAX mark, otherwise boiling water may be ejected.

Always pour hot water slowly and carefully without tipping the appliance too fast to prevent splashing and spillage.

Do not hold the switch in the on position or tamper with the switch to fix it in the on position as this may cause damage to the switch-off mechanism.

Do not move the kettle while switched on.

The use of attachments or tools not recommended or sold by Morphy Richards, may cause fire, electric shock or injury.

The kettle is only to be used with the stand provided.

Do not use the appliance for any use other than to boil water.

The appliance must not be on the base unit when being filled with water.

Unplug from the outlet when not in use.

WARNING: The appliance must not be immersed for cleaning.

WARNING: When boiled, allow a few seconds before pouring.

Check that the voltage on the rating plate of your appliance corresponds with your house electricity supply which must be A.C. (Alternating Current).

Should the fuse in the mains plug require changing, a 13 amp BS1362 fuse must be fitted.

KT102002 MUK Rev 3 01/15

Your standard one year guarantee is extended for an additional 12 months when you register the product within 28 days of purchase with Morphy Richards. If you do not register the product with Morphy Richards within 28 days, your product is guaranteed for 1 year. To validate your 2 year guarantee register with us online at

Or call our customer registration line

N.B. Each qualifying product needs to be registered with Morphy Richards individually.

Please note that the 2 year guarantee is only available in the UK and Ireland. Please refer to the one year guarantee for more information.

It is important to retain the retailer's receipt as proof of purchase. Staple your receipt to this back cover for future reference.

Please quote the following information if the product develops a fault. These numbers can be found on the base of the product.

Model no.

Serial no.

All Morphy Richards products are individually tested before leaving the factory. In the unlikely event of any appliance proving to be faulty within 28 days of purchase, it should be returned to the place of purchase for it to be replaced.

If the fault develops after 28 days and within 12 months of original purchase, you should contact the Helpline number quoting Model number and Serial number on the product, or write to Morphy Richards at the address shown.

You may be asked to return a copy of proof of purchase.

Subject to the exclusions set out below (see Exclusions), the faulty appliance will then be repaired or replaced as appropriate and dispatched usually within 7 working days of receipt.

If, for any reason, this item is replaced or repaired during the 1 year guarantee period, the guarantee on the new item will be calculated from original purchase date. Therefore it is vital to retain your original till receipt or invoice to indicate the date of initial purchase.

To qualify for the 1 year guarantee, the appliance must have been used according to the instructions supplied. For example, crumb trays should have been emptied regularly.

Morphy Richards shall not be liable to replace or repair the goods under the terms of the guarantee where:

The fault has been caused or is attributable to accidental use, misuse, negligent use or used contrary to the manufacturer's recommendations or where the fault has been caused by power surges or damage caused in transit.

The appliance has been used on a voltage supply other than that stamped on the products.

Repairs have been attempted by persons other than our service staff (or authorised dealer).

The appliance has been used for hire purposes or non domestic use.

The appliance is second hand.

Morphy Richards reserves the right not to carry out any type of servicing under the guarantee at its discretion

Plastic filters for all Morphy Richards kettles and coffee makers are not covered by the guarantee.

Batteries and damage from leakage are not covered by the guarantee.

This guarantee does not confer any rights other than those expressly set out above and does not cover any claims for consequential loss or damage. This guarantee is offered as an additional benefit and does not affect your statutory rights as a consumer. Morphy Richards products are intended for household use only. See usage limitations within the location safety instructions.

Morphy Richards has a policy of continuous improvement in product quality and design. The company, therefore reserves the right to change the specification of its models at any time.



For electrical products sold within the European Community. At the end of the electrical products useful life, it should not be disposed of with household waste.

Please recycle where facilities exist. Check with your Local Authority or retailer for recycling advice in your country

morphy richards

The After Sales Division
Morphy Richards Ltd
Mexborough, South Yorkshire,
England, S64 8AJ

Helplines (office hours)
UK 0344 871 0944
Spare Parts 0344 873 0710
Republic of Ireland 1800 409 119
www.morphyrichards.com



KT102002 MUK Rev 3

morphyrichards®

smart ideas for your home



Accents Traditional Kettle

 Please read and keep these instructions for future use

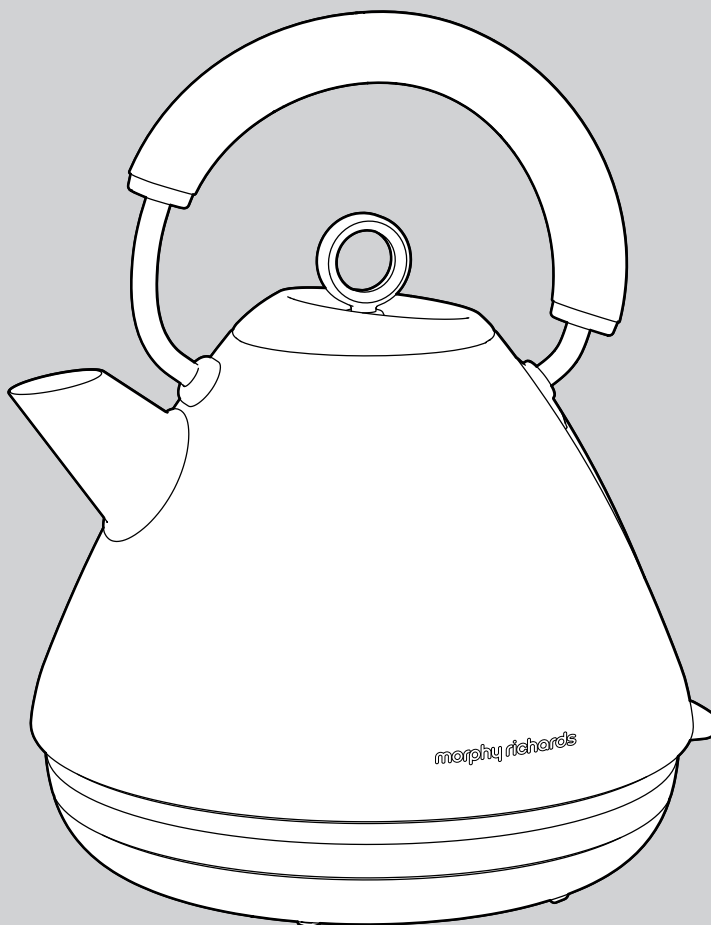

For competitions, product hints and tips and more join us at



www.morphyrichards.co.uk/blog



www.facebook.com/morphyrichardsuk



[@loveyourmorphy](https://twitter.com/loveyourmorphy)

www.morphyrichards.com

*Register online for your 2 year guarantee. See back of this instruction book for details (UK and Ireland customers only).

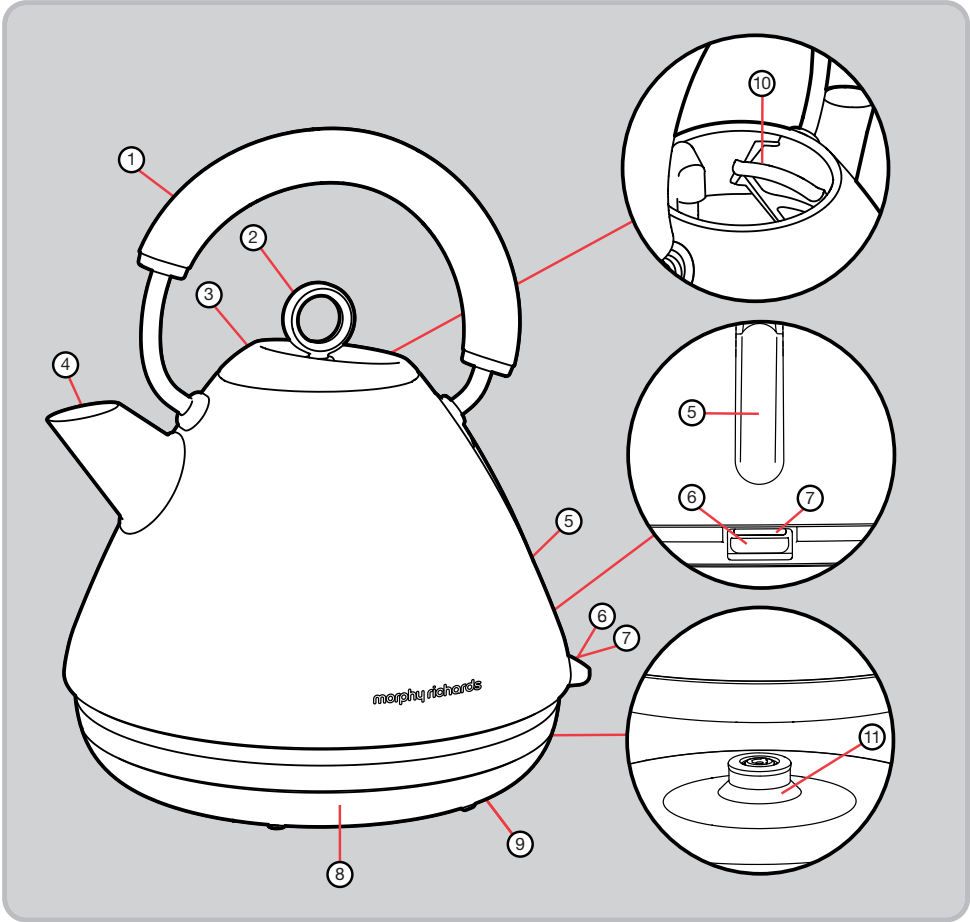

- (1) Handle
- (2) Ring Pull
- (3) Lid
- (4) Spout
- (5) Water Gauge
- (6) On/Off Switch
- (7) Indicator Light
- (8) Cordless Base
- (9) Cord Storage (underneath)
- (10) Filter
- (11) 360° Connector

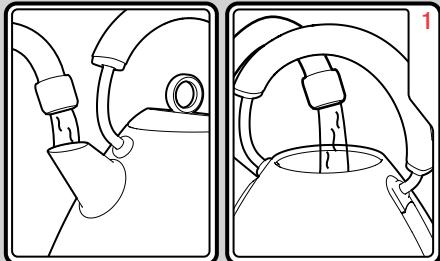

Fill the kettle with water through either the Spout (4) or Lid (3), do not fill past the MAX line.

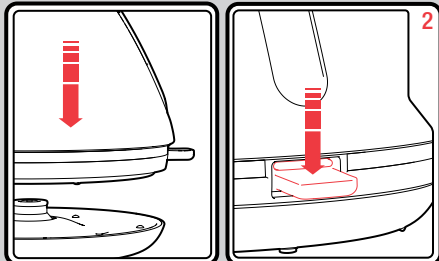

Place the kettle on the Cordless Base (8) and press the On/Off Switch (6).

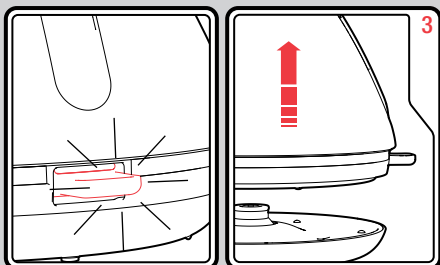

When boiled, the kettle will automatically switch off. Remove from the Cordless Base.

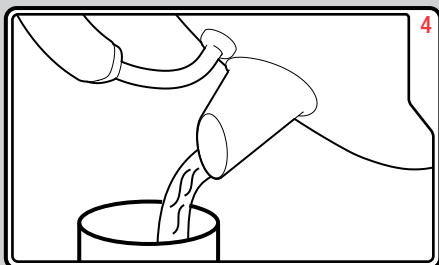

Pour the water from the kettle.
WARNING: When boiled, allow a few seconds before pouring.

Before using the appliance for the first time, fill with water, boil and pour away.

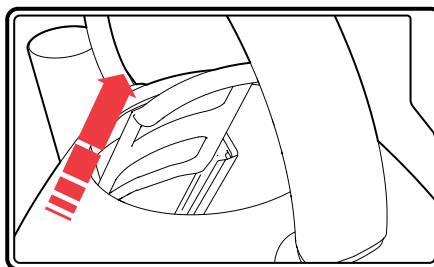

Open the Lid .

Lift the Filter upwards from its holder.

To refit the Filter, slide it into the side wall guides of the filter holder until it clicks into place.

WARNING: Unless the filter is fitted correctly, the kettle lid may not close and lock securely.

WARNING: Always disconnect the plug from the mains and allow the kettle to cool before cleaning.

Wipe the outside with a damp cloth.

IMPORTANT: Do not use abrasive cleaners on the outside of the kettle which may scratch the surface.

IMPORTANT: As this appliance is fitted with a concealed element it must be descaled regularly. The frequency of descaling depends on usage and the hardness of the water in your area.

Excessive scale can cause the appliance to switch off before boiling and may damage the element invalidating the warranty.

It is essential that regular descaling takes place. We recommend descaling your kettle every two months.

Remove hard scale using a proprietary descaling product suitable for stainless steel, glass or plastic.

IMPORTANT: Ensure that the electrical connections are completely dry before using the appliance.

IMPORTANT: Ensure that the electrical connections are completely dry before using the appliance.

Unplug from the outlet before cleaning.

Allow to cool before putting on or taking off parts and before cleaning.

CAUTION: To prevent damage to the appliance, do not use alkaline cleaning agents when cleaning. Use a soft cloth and detergent.

If you are having a problem with your appliance, please call our Helpline, as we are more likely to be able to help than the store you purchased the item from.

Please have the product name, model number and serial number to hand when you call to help us deal with your enquiry quicker.

UK Helpline: 0344 871 0944

IRE Helpline: 1800 409 119

Spares: 0344 873 0710

If you have any questions or comments, or want some great tips or recipe ideas to help you get the most out of your products, join us online:

Blog: www.morphyrichards.co.uk/blog

Facebook: www.facebook.com/morphyrichardsuk

Twitter: [@loveyourmorphy](https://twitter.com/loveyourmorphy)

Website: www.morphyrichards.com