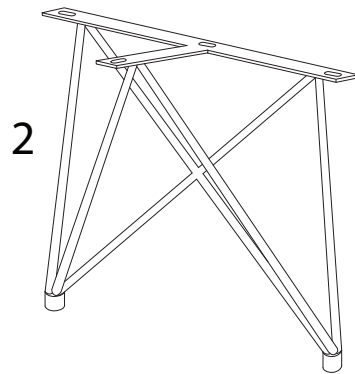
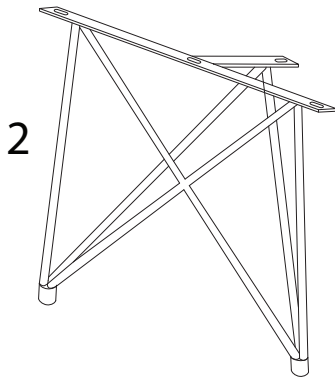
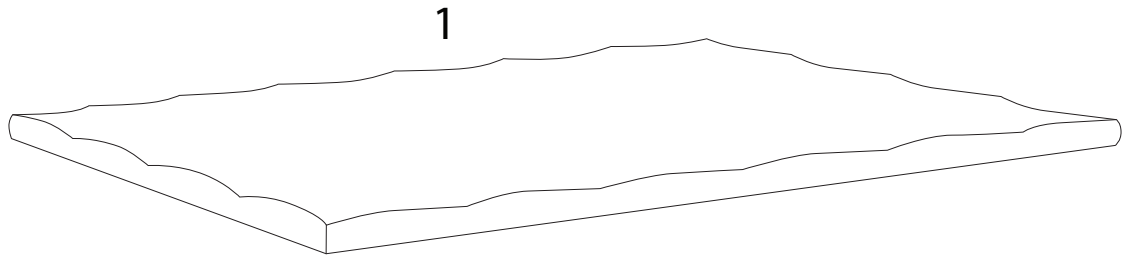

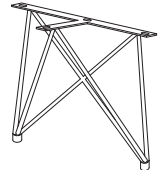
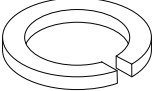
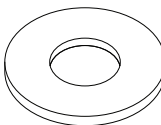
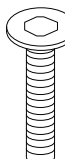
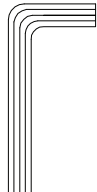



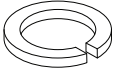

Diagram illustrating assembly instructions and safety warnings:

- Warning 1:** A warning triangle with an exclamation mark is shown next to a box containing an L-shaped metal bracket and a power drill with a slash through it, indicating that a power drill should not be used for this step.
- Warning 2:** A second warning triangle with an exclamation mark is shown next to a box containing a rectangular block being placed on a surface and a diagram of a block being secured with a bolt and nut, indicating a safety or stability warning.
- Time:** A clock icon is shown next to the text "10'", indicating a 10-minute assembly time.
- Personnel:** A person icon is shown next to the number "2", indicating that two people are required for assembly.



1	2	A	B	C	D
					
x 1	x 2	x 8	x 8	M5 x 23 x 8	x 1

1

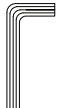
<p>1</p>  <p>x 1</p>	<p>2</p>  <p>x 2</p>	<p>A</p>  <p>x 8</p>	<p>B</p>  <p>x 8</p>	<p>C</p>  <p>M5 x 23</p> <p>x 8</p>	<p>D</p>  <p>x 1</p>
---	---	---	--	--	---

