

# **OLYMPUS**

**DIGITAL CAMERA**

# ***E-M1X***

## **Instruction Manual**



**CE**

**Model No. : IM010**

- Thank you for purchasing an Olympus digital camera. Before you start to use your new camera, please read these instructions carefully to enjoy optimum performance and a longer service life. Keep this manual in a safe place for future reference.
- We recommend that you take test shots to get accustomed to your camera before taking important photographs.
- The screen and camera illustrations shown in this manual were produced during the development stages and may differ from the actual product.
- If there are additions and/or modifications of functions due to firmware update for the camera, the contents will differ. For the latest information, please visit the Olympus website.

# Product Manuals

In addition to the “Instruction Manual”, we also offer a “Camera Function Guide”. Consult these manuals when using the product.

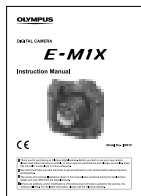

## Instruction Manual (this pdf)

A how-to guide to the camera and its features. The Instruction Manual can be downloaded from the OLYMPUS website or directly using the “OLYMPUS Image Share” (OI.Share) smartphone app.



## Camera Function Guide

A function and setting guide that helps you use camera features to the full. It has been optimized for display on mobile devices and can be viewed using OI.Share.  
<http://cs.olympus-imaging.jp/jp/support/cs/webmanual/index.html>



## Symbols Used in This Manual

The following symbols are used in this manual:

	Tips and other helpful information for using the camera.
	Notes and other supplementary information.
	References to other pages in this manual.

<b>Product Manuals</b>	P. 2
<b>Table of Contents</b>	P. 4
<b>Feature Index</b>	P. 16
<b>Parts of the Camera</b>	P. 20
<b>Package Contents</b>	P. 24
<b>Before You Begin</b>	P. 25
<b>1 Getting Ready</b>	P. 27
Read this chapter, together with the other relevant sections of this manual, when using the camera to take photographs or film movies.	
<b>2 Taking and Viewing Photographs</b>	P. 51
Read this chapter for information on using the camera to take photographs. This chapter also covers the features you'll use when shooting and viewing photos.	
<b>3 Shooting and Viewing Movies</b>	P. 293
Read this chapter for information on using the camera to record movies. This chapter also covers the features needed to record movies and view them on the camera.	
<b>4 Customizing the Camera</b>	P. 453
Customize camera buttons and dials to suit your shooting style.	
<b>5 Using Field Sensor Data</b>	P. 567
Read this chapter for information on using the camera's built-in sensors and GPS feature.	
<b>6 Connecting the Camera to External Devices</b>	P. 581
Connect the camera to external devices such as computers or displays using cables or via wireless LAN.	
<b>7 Technical Notes</b>	P. 631
This chapter covers such topics as camera maintenance and provides a list of default settings that you can refer to while using the camera.	
<b>8 SAFETY PRECAUTIONS</b>	P. 663
This chapter includes safety precautions for using your camera. Be sure to read them.	
<b>9 Index</b>	P. 675

1

2

3

4

5

6

7





8

9

# Table of Contents

<b>Product Manuals .....</b>	<b>2</b>
<b>Feature Index .....</b>	<b>16</b>
<b>Parts of the Camera .....</b>	<b>20</b>
<b>Package Contents .....</b>	<b>24</b>
<b>Before You Begin .....</b>	<b>25</b>
<b>1 Getting Ready .....</b>	<b>27</b>
Attaching the Strap .....	28
Attaching Cable Protectors.....	29
Removing the Eyecup .....	30
Inserting and Removing Batteries .....	31
Batteries and Chargers .....	33
Using Your Charger Abroad .....	33
Using External Power Sources.....	34
Connecting via USB.....	34
Optional AC Adapters .....	35
1-1 Inserting Memory Cards .....	36
Using Two Memory Cards.....	37
Memory Cards .....	37
Formatting Memory Cards (Card Setup) .....	38
1-2 Attaching Lenses .....	39
Removing Lenses .....	40
MF Clutch Lenses .....	41
Interchangeable Lenses .....	42
1-3 Using the Monitor.....	43
1-4 Turning the Camera On .....	44
Sleep Mode.....	44
1-5 Initial Setup .....	45
What to Do If You Can't Read the Display.....	47
Correcting the Clock Using GPS .....	48
1-6 Focusing the Viewfinder.....	49



<b>2</b>	<b>Taking and Viewing Photographs .....</b>	<b>51</b>
2-1	Basic Photography and Playback .....	52
	Taking Photos .....	52
	Holding the Camera .....	52
	Taking Photos with the Shutter Button .....	53
	Taking Photos with Touch Controls .....	54
	Remote Photography .....	55
	Viewing Photographs .....	56
	Choosing a Memory Card .....	57
	Adjusting Volume .....	58
	Playback Using Touch Controls .....	58
2-2	Shooting Settings .....	59
	Direct Buttons .....	60
	The Super Control/LV Super Control Panel .....	62
	Using the Menus .....	66
	Using Live Controls .....	68
2-3	Card-Related Settings .....	71
	Storage Options (  Save Settings) .....	72
	Choosing a Card for Photos (  Save Slot) .....	74
	Storage Slot Selection .....	75
	Storage Folder Selection (Assign Save Folder) .....	76
2-4	Image Quality and Size .....	78
	Photo File and Image Size Options (   ) .....	78
	Choosing Available Options (  Set) .....	81
	Choosing Values for [M] and [S] Sizes (Pixel Count) .....	82
2-5	The Viewfinder and Monitor Displays .....	83
	Display Selection .....	83
	Choosing the Information Displayed .....	84
	Display Selection Options (EVF Auto Switch) .....	85
	The Shooting Display .....	86
	Optical Viewfinder Simulation (S-OVF) .....	89
2-6	Photo Review (Rec View) .....	90
2-7	Restoring Default Settings (Reset) .....	91
2-8	Choosing a Shooting Mode .....	93
	Letting the Camera Choose Aperture and Shutter Speed (P: Program AE) .....	94
	Adjusting Settings in Mode P .....	95
	Program Shift .....	95

Choosing an Aperture ( <b>A</b> : Aperture-Priority AE).....	96
Adjusting Settings in Mode <b>A</b> .....	97
Choosing a Shutter Speed ( <b>S</b> : Shutter-Priority AE).....	98
Adjusting Settings in Mode <b>S</b> .....	100
Choosing Aperture and Shutter Speed ( <b>M</b> : Manual Exposure).....	101
Adjusting Settings in Mode <b>M</b> .....	102
Using Exposure Compensation in Mode <b>M</b> .....	103
Long Exposures ( <b>B</b> : Bulb/Time) .....	104
Adjusting Focus During Exposures (Bulb/Time Focusing).....	107
Lighten Blending ( <b>B</b> : Live Composite Photography).....	108
Choosing the Shutter Speed (Composite Settings) .....	110
Saving Custom Settings to the Mode Dial	
( <b>C1/C2/C3/C4</b> Custom Modes) .....	111
Saving Settings (Assign to Custom Mode) .....	111
Using Custom Modes ( <b>C1/C2/C3/C4</b> ) .....	112
2-9 Focus.....	114
Focus Mode (📷 AF Mode).....	115
Choosing an AF-Target Mode (AF Target Mode).....	120
Choosing a Focus Target (AF Target Point) .....	123
Custom AF Targets (📷 Target Mode Settings) .....	125
Lens MF Clutch (Manual Focus Clutch) .....	127
Disabling the MF Clutch (MF Clutch) .....	128
Focusing at a Preset Distance (Preset MF) .....	129
Face/Eye Priority AF.....	133
Using Face/Eye Priority AF .....	135
Zoom Frame/Focus Zoom AF (Super Spot AF).....	136
Assigning [ <b>Q</b> ] (Magnify) to a Control .....	136
Using [ <b>Q</b> ] (Magnify) .....	137
Focus Zoom Options (LV Close Up Settings).....	139
Setting Focus and Exposure with the <b>AEL/AFL</b> Button	
(📷 AEL/AFL).....	141
Lens Focus Range (AF Limiter) .....	143
C-AF Tracking Sensitivity (📷 C-AF Sensitivity).....	145
C-AF Lens Scanning (AF Scanner).....	146
C-AF Starting Focus Target (📷 C-AF Center Start) .....	147
C-AF Center Target Priority (📷 C-AF Center Priority) .....	148
Tracking Focus on Selected Subjects (📷 Tracking Subject).....	149



























2-10 Drive Mode (  /  /  ) .....	151
Sequential Shooting/Self-Timer.....	151
Burst Shooting Options (  L Settings /  H Settings) .....	155
Self-Timer Options (  Custom Self-timer) .....	157
Reducing Shutter Slap (Anti-Shock  ) .....	160
Adjusting Anti-Shock Settings.....	160
The Electronic Shutter (Silent  ).....	163
Long Exposure Noise Reduction (Noise Reduction  ).....	166
Silent-Mode Options (Silent  Mode Settings) .....	167
Reducing Shutter Lag (Pro Capture Photography) .....	168
Interval-Timer Photography (Intrvl. Sh./Time Lapse).....	172
Burst Mode Image Stabilization (  Image Stabilization) .....	174
Viewfinder Display Rate (Frame Rate).....	175
2-11 Image Stabilization .....	176
Reducing Camera Blur (  Image Stabilizer).....	176
Half-Press Image Stabilization (Half Way RIs With IS).....	178
2-12 Metering and Exposure.....	179
Adjusting Exposure (Exposure Compensation).....	180
Adjusting ISO Sensitivity (  ISO) .....	181
Options for [  ISO ] > [AUTO] (  ISO-Auto Set) .....	183
Shooting Mode and [  ISO ] > [AUTO] (  ISO-Auto) .....	185
Exposure Metering (Metering).....	186
Locking Exposure (AE Lock) .....	188
Reducing Flicker (Flicker Reduction) .....	190
Reducing Flicker in Live View (Anti-Flicker LV) .....	190
Reducing Flicker in Photographs (Anti-Flicker Shooting) .....	191
Reducing Flicker Under LED Lighting (  Flicker Scan).....	193
High Dynamic Range (HDR) .....	195
Slowing the Shutter in Bright Light (Live ND Shooting).....	197
Live View Exposure Preview (Live View Boost) .....	200
2-13 Color and Quality .....	202
Adjusting Hue (  WB) .....	202
Preserving Warm Colors (  <sup>WB</sup> AUTO Keep Warm Color).....	205
Fine-Tuning White Balance (  White Balance Compensation)...	206
Metering White Balance (One-Touch White Balance  /  /  /  ) .....	207
High-Resolution Photos (High Res Shot) .....	210
High Res Shot Image Quality (   ) .....	213

Image Enhancement (Picture Mode) .....	215
Choosing a Picture Mode .....	217
Creating Custom Picture Modes (C Custom Picture Mode) .....	219
Adjusting Sharpness (Sharpness) .....	220
Adjusting Contrast (Contrast) .....	221
Adjusting Vividness (Saturation) .....	222
Adjusting Shading (Gradation) .....	223
Color Filters for Black-and-White Photography (Color Filter) .....	224
Monochrome Tints (Monochrome Color) .....	225
Adjusting i-Enhance Effects (Effect) .....	226
Choosing a Tone Curve (Highlight&Shadow Control) .....	227
Hue and Saturation (Color Creator) .....	229
“Leave Color” Effects (Partial Color) .....	231
Choosing a Color Space (Color Space) .....	232
2-14 Effects .....	233
Aspect Ratio (Image Aspect) .....	233
Zoom (Digital Tele-converter) .....	235
Varying Settings Little-by-Little over a Series of Shots (Bracketing) .....	236
Increasing Depth of Field (Focus Stacking) .....	243
Overlaying Pictures (Multiple Exposure) .....	246
Keystone Effects/Enhancing Perspective (Keystone Comp.) .....	248
Correcting Fisheye Distortion (Fisheye Compensation) .....	250
2-15 Flash Photography .....	252
Compatible Flash Units .....	252
Choosing a Flash Mode (Flash Mode) .....	254
Adjusting Flash Output (Flash) .....	259
Choosing a Flash Sync Speed (X-Sync.) .....	260
Setting a Slow Shutter Speed Limit (Slow Limit) .....	261
Wireless Remote Flash Control .....	262
Third-Party Flash Units .....	264
2-16 Working with Saved Images .....	265
Choosing the Information Displayed .....	265
The Playback Info Display .....	266
Zooming In (Playback Zoom) .....	267
Finding Pictures Quickly (Index and Calendar Playback) .....	268
Rotating Pictures (Rotate) .....	269
Protecting Pictures (Protect) .....	270
Removing Protection from All Pictures (Reset Protect) .....	271

Copying Pictures Between Cards (Copy).....	272
Copying All Pictures (Copy All) .....	274
Deleting Pictures (Erase) .....	275
Deleting All Pictures (All Erase).....	276
Selecting Pictures for Sharing (Share Order).....	277
Removing Share Marking from All Pictures (Reset Share Order).....	278
Selecting Multiple Pictures (O/Copy Select/Erase Selected/Share Order Selected) .....	279
Adding Audio to Pictures (G).....	281
Automatically Rotating Portrait-Orientation Pictures for Playback (F).....	283
Retouching Pictures (Edit).....	284
Retouching RAW Pictures (RAW Data Edit) .....	284
Retouching JPEG Pictures (JPEG Edit) .....	287
Combining Pictures (Image Overlay) .....	289
Selecting Pictures for Printing (P—DPOF) .....	291
<b>3 Shooting and Viewing Movies .....</b>	<b>293</b>
3-1 Basic Recording and Playback.....	294
An Introduction to Movie Recording .....	294
Recording Movies.....	295
Holding the Camera.....	295
Recording Movies with the Touch Screen.....	295
Remote Photography .....	297
Touch Screen Options .....	298
Focus Zoom (F).....	298
Using the Viewfinder .....	299
Viewing Movies .....	300
Playback Volume .....	301
Viewing Movies over 4 GB in Size.....	301
Choosing a Memory Card.....	302
Playback Using Touch Controls .....	303
3-2 Shooting Settings.....	304
Direct Buttons.....	305
Touch Controls (Silent Controls).....	306
The LV Super Control Panel.....	309
Using Live Controls .....	312
Using the Menus .....	314



3-3	Card-Related Settings .....	316
	Choosing a Card for Movies (📁 Save Slot) .....	316
	Storage Slot Selection.....	318
	Storage Folder Selection (Assign Save Folder) .....	319
3-4	Movie File Settings .....	321
	Frame Size, Rate, and Compression (📺 ⏪).....	321
	Time Codes (Time Code Settings) .....	324
3-5	The Viewfinder and Monitor Displays .....	326
	Choosing the Information Displayed .....	327
	Display Selection Options (EVF Auto Switch) .....	328
	The Shooting Display .....	329
	Restoring Default Settings (Reset).....	331
3-6	Movie Recording Options .....	332
	Choosing an Exposure Mode (📷 Mode) .....	332
	Letting the Camera Choose Aperture and Shutter Speed (P: Program AE).....	334
	Choosing an Aperture (A: Aperture-Priority AE) .....	335
	Choosing a Shutter Speed (S: Shutter-Priority AE) .....	336
	Choosing Aperture and Shutter Speed (M: Manual Exposure) .....	337
	Filming High-Speed Movies (📺 ⏪).....	339
	Filming Slow- or Fast-Motion Movies (Slow- and Fast-Motion Movies).....	342
3-7	Focus.....	345
	Focus Mode (📷 AF Mode) .....	345
	Choosing an AF Target Mode (AF Target Mode).....	349
	Choosing a Focus Target (AF Target Point) .....	352
	Lens MF Clutch (Manual Focus Clutch) .....	355
	Disabling the MF Clutch (MF Clutch).....	356
	Focusing at a Preset Distance (Preset MF) .....	357
	Face Priority AF.....	360
	Using Face Priority AF .....	361
	C-AF Tracking Sensitivity (📷 C-AF Sensitivity).....	362
	C-AF Focus Speed (📷 C-AF Speed).....	363
	Zoom Frame/Focus Zoom AF .....	364
3-8	Metering and Exposure.....	367
	Adjusting Exposure (Exposure Compensation).....	367
	Adjusting ISO Sensitivity (📷 ISO) .....	369
	Auto ISO Sensitivity Control (📷M ISO-Auto Set).....	372
	Locking Exposure (AE Lock).....	373
	Reducing Flicker Under LED Lighting (📷 Flicker Scan) .....	374





3-9	Image Stabilization, Color, and Quality .....	376
	Reducing Camera Blur (Image Stabilizer) .....	376
	Image Stabilization Options (IS Level).....	378
	High ISO Noise Reduction Options (Noise Filter).....	379
	Adjusting Hue (WB) .....	380
	Preserving Warm Colors (WB AUTO Keep Warm Color) .....	383
	White Balance Compensation (White Balance Compensation).....	384
	Fine-Tuning White Balance (All WBZ).....	385
	Metering White Balance (One-Touch White Balance Mg/Mg/Mg/Mg).....	386
	Image Enhancement (Picture Mode) .....	388
	Choosing a Picture Mode .....	390
	Creating Custom Picture Modes (Custom Picture Mode).....	392
	Highlight&Shadow Control (Picture Mode) .....	393
	Preview Options for Movie Picture Modes (View Assist).....	395
	Adjusting Sharpness (Sharpness).....	396
	Adjusting Contrast (Contrast).....	397
	Adjusting Vividness (Saturation) .....	398
	Adjusting Shading (Gradation) .....	399
	Color Filters for Black-and-White Photography (Color Filter).....	400
	Monochrome Tints (Monochrome Color).....	401
	Adjusting i-Enhance Effects (Effect).....	402
	Choosing a Tone Curve (Highlight&Shadow Control) .....	403
	Hue and Saturation (Color Creator) .....	405
	"Leave Color" Effects (Partial Color) .....	407
3-10	Effects.....	408
	Power Zoom (Elec. Zoom Speed) .....	408
	Adjusting Zoom During Filming (Movie ) .....	409
	Filming at a Higher Zoom Ratio (Digital Tele-converter) .....	411
3-11	Audio Recording .....	412
	Sound Recording Options (Movie ) .....	413
	Using the Olympus LS-100 IC Recorder.....	415
3-12	Customizing Camera Controls.....	417
	Assigning Roles to Buttons (Button Function) .....	417
	Choosing a Role for the Shutter Button (Shutter Function) .....	423
	Assigning Roles to the Front and Rear Dials (Dial Function) .....	424
	Customizing the Fn Lever (Fn Lever Function).....	426
3-13	Display Settings .....	428
	Viewing On-Screen Controls (Control Settings).....	428
	Shooting Indicators (Info Settings).....	429
	Battery Level Display Options (Display Pattern) .....	431

3-14	HDMI Devices.....	432
	HDMI Output (HDMI Output) .....	432
	External Monitor Display Options (HDMI) .....	434
3-15	Working with Saved Movies.....	436
	Choosing the Information Display .....	436
	The Movie Playback Info Display .....	437
	Finding Movies Quickly (Index and Calendar Playback) .....	438
	Protecting Movies (Protect) .....	439
	Removing Protection from All Pictures (Reset Protect) .....	440
	Copying Pictures Between Cards (Copy) .....	441
	Copying All Pictures (Copy All) .....	443
	Deleting Pictures (Erase) .....	444
	Deleting All Pictures (All Erase) .....	445
	Selecting Movies for Sharing (Share Order) .....	446
	Removing Share Marking from All Pictures (Reset Share Order) .....	447
	Selecting Multiple Pictures (Protect/Copy Select/Erase Selected/ Order Selected) .....	448
	Editing Movies (Movie Edit) .....	450
	Trimming Movies (Movie Trimming) .....	450
	Creating Movie Stills (In-Movie Image Capture) .....	451
<b>4</b>	<b>Customizing the Camera.....</b>	<b>453</b>
4-1	Basic Camera Settings (the Setup Menu) .....	454
	Formatting Memory Cards and Deleting All Photos and Movies (Card Setup) .....	454
	Setting the Camera Clock (Settings) .....	455
	Choosing a Language (Language) .....	455
	Monitor Brightness and Hue (Monitor) .....	456
	Post-Shooting Display Time (Rec View) .....	456
	Wireless LAN Options (Wi-Fi/Bluetooth Settings) .....	457
	Viewing the Firmware Version (Firmware) .....	457
4-2	Custom Shooting Modes .....	458
	Saving Settings to the Mode Dial (Assign to Custom Mode) .....	458
	Using Custom Modes (C1/C2/C3/C4) .....	460
4-3	Customizing Buttons and Dials .....	462
	Assigning Roles to Buttons (Button Function) .....	463
	Multi-Function Button Options (Multi Function) .....	470
	Assigning Roles to the Front and Rear Dials (Dial Function) .....	473
	Customizing the Fn Lever (Fn Lever Function) .....	475











































4-4	“My Menu”.....	477
	Creating a Personalized Menu (My Menu).....	477
4-5	Customizing Camera Functions.....	480
	Focus-Related Items (Custom Menus <b>A1</b> , <b>A2</b> , <b>A3</b> , and <b>A4</b> ).....	480
	Control-Related Items (Custom Menus <b>B1</b> and <b>B2</b> ).....	498
	Release-Related Items (Custom Menus <b>C1</b> and <b>C2</b> ).....	505
	Display-, Sound-, and Connection-Related Items (Custom Menus <b>D1</b> , <b>D2</b> , <b>D3</b> , and <b>D4</b> ).....	513
	Exposure-Related Items (Custom Menus <b>E1</b> , <b>E2</b> , and <b>E3</b> ).....	530
	Flash-Related Items (Custom Menu <b>F</b> ).....	539
	Image Quality, White Balance, and Color-Related Items (Custom Menu <b>G</b> ).....	542
	Storage- and Deletion-Related Items (Custom Menus <b>H1</b> and <b>H2</b> ).....	547
	Viewfinder-Related Items (Custom Menu <b>I</b> ).....	553
	Other Custom Settings (Custom Menus <b>J1</b> , <b>J2</b> , and <b>J3</b> ).....	558
<b>5</b>	<b>Using Field Sensor Data .....</b>	<b>567</b>
5-1	Notes on Field Sensors .....	568
	GPS: Precautions for Use .....	568
	Before Using GPS (A-GPS Data).....	569
	Updating the A-GPS Data Using a Smartphone.....	569
	Updating the A-GPS Data Using a PC.....	569
5-2	Using Field Sensors.....	570
	Recording Location Data (Record GPS location).....	570
	Field Sensor Logs .....	571
	Logging Data (Field Sensor Logger).....	571
	Viewing Sensor Data (📶/Info Settings).....	574
	Enabling Sensor Data Display .....	575
	Sensor Data Display Options (Elevation/Temperature).....	578
	GPS Options (GPS Priority).....	579
5-3	Disabling GPS .....	580
<b>6</b>	<b>Connecting the Camera to External Devices .....</b>	<b>581</b>
6-1	Connection Types and Software.....	582
	Precautions for Using Wi-Fi and <b>Bluetooth</b> ®.....	583
6-2	Connecting to Smartphones via Wi-Fi .....	584
	Installing Apps .....	585
	Connecting to Smartphones (Wi-Fi/Bluetooth Settings).....	586
	Readying the Camera (Availability).....	586
	Pairing the Camera and Smartphone .....	587
	Connecting When the Camera Is Off (Power-off Standby) .....	590



















	Copying Pictures to Smartphones.....	592
	Downloading Pictures Selected with OI.Share .....	592
	Auto Download .....	594
	Removing Share Marking (Reset Share Order).....	595
	Remote Photography Using a Smartphone.....	596
	Accessing Field Sensor Logs.....	597
	Ending the Connection .....	598
	Ending the Current Connection .....	598
	Disabling Wi-Fi/ <b>Bluetooth</b> <sup>®</sup> .....	598
6-3	Connecting to Computers via Wi-Fi .....	600
	Installing Software .....	601
	Readying the Computer (Windows) .....	602
	Pairing the Computer with the Camera (New Link) .....	603
	Adjusting Wi-Fi Settings ((  ) Wi-Fi Connect).....	605
	Enabling Camera Wi-Fi (Wi-Fi/Bluetooth Settings).....	606
	Connecting via WPS (Connect by WPS) .....	607
	Connecting Manually (Manual Connections) .....	609
	Choosing a Network from a List (Connect from Access Point List) .....	612
	Uploading Pictures as They Are Taken .....	614
	Ending the Connection .....	616
	Ending the Current Connection .....	616
	Disabling Wi-Fi/ <b>Bluetooth</b> <sup>®</sup> .....	617
6-4	Network Settings.....	618
	Changing Passwords (Connection Password) .....	618
	Restoring Default Wi-Fi/ <b>Bluetooth</b> <sup>®</sup> Settings (Reset Settings) .....	619
6-5	Connecting to Computers via USB .....	620
	Compatible Computers.....	621
	Installing Software .....	621
	Uploading Pictures as They Are Taken (  ) .....	622
	Copying Pictures to the Computer (Storage) .....	624
6-6	Powering the Camera via USB (USB Power Delivery) .....	625
6-7	Connecting to TVs or External Displays via HDMI.....	626
	Viewing Pictures on a TV (HDMI).....	627
	HDMI Output .....	627
	Connecting the Camera to a TV .....	629
	Using a TV Remote (HDMI Control).....	630













<b>7</b>	<b>Technical Notes.....</b>	<b>631</b>
7-1	Storage and Maintenance.....	632
7-2	Troubleshooting .....	634
7-3	Warnings and Error Messages .....	637
7-4	Default Settings .....	640
	Live Controls/LV Super Control Panel .....	640
	The  Shooting Menu .....	642
	The  Video Menu .....	643
	The  Playback Menu .....	645
	The  Setup Menu .....	646
	The  Custom Menus.....	647
7-5	Memory Card Capacity .....	654
7-6	Specifications.....	656
7-7	System Chart.....	660
<b>8</b>	<b>SAFETY PRECAUTIONS.....</b>	<b>663</b>
<b>9</b>	<b>Index .....</b>	<b>675</b>

# Feature Index

Feature	
Shooting Mode	93–110
Custom Mode	111, 460
Monitor Display	83, 326
Viewfinder Display	83, 326
Direct Button Functions	60, 305
Live Controls	68, 312
LV Super Control Panel	62, 309
 Shooting Menu 1	
Reset / Custom Modes	91, 111, 331, 458, 460
Picture Mode	215, 388
	78, 82, 213, 543
Image Aspect	233
Digital Tele-converter	235, 411
 (Drive Mode)	151
 Shooting Menu 2	
Bracketing	236
HDR	195
Multiple Exposure	246
Keystone Comp.	248
Anti-Shock [  ]/Silent [  ]	160, 163
High Res Shot	210
Live ND Shooting	197
 Video Menu	
 Mode Settings	
 Mode	332
 Flicker Scan	374





Feature	
 Specification Settings	
	321, 339
 ISO-Auto Set	372
 Noise Filter	379
 WB	380
 All 	385
  Keep Warm Color	383
 Picture Mode	393
 AF/IS Settings	
 AF Mode	345
 C-AF Speed	363
 C-AF Sensitivity	362
 Image Stabilizer	376
 IS Level	378
 Button/Dial/Lever	
 Button Function	417
 Dial Function	424
 Fn Lever Function	426
 Shutter Function	423
 Elec. Zoom Speed	408
 Display Settings	
 Control Settings	428
 Info Settings	429
Time Code Settings	324
 Display Pattern	431
 View Assist	395
Movie 	413
 HDMI Output	432







Feature	
<b>▶ Playback Menu</b>	
	283
Edit	284
Print Order	291
Reset Protect	271, 440
Reset share Order	278, 447
Copy All	274, 443
 Wi-Fi Connect	586
<b>⚙ Custom Menu</b>	
<b>A1 AF/MF</b>	
 AF Mode	115
 AF+MF	481
 AEL/AFL	141
AF Scanner	146, 482
 C-AF Sensitivity	145, 483
 C-AF Center Start	147, 483
 C-AF Center Priority	148, 484
<b>A2 AF/MF</b>	
  Mode Settings	485
AF Area Pointer	486
AF Targeting Pad	486
 Set Home	487
 Select Screen Settings	488
 Target Mode Settings	125, 488
 Orientation Linked 	489
<b>A3 AF/MF</b>	
AF Limiter	143, 490
AF Illuminator	490
 Face Priority	133, 360, 491
 Tracking Subject	149, 491
AF Focus Adj.	492

Feature	
<b>A4 AF/MF</b>	
Preset MF distance	129, 357, 494
MF Assist	495
MF Clutch	128, 356, 496
Focus Ring	496
Bulb/Time Focusing	107, 497
Reset Lens	497
<b>B1 Button/Dial/Lever</b>	
 Button Function	463
 Center Button	499
 Direction Key	499
 Dial Function	473, 500
Dial Direction	500
 Fn Lever Function	475, 501
Fn Lever/Power Lever	501
<b>B2 Button/Dial/Lever</b>	
 Elec. Zoom Speed	502
C-LOCK Settings	503
<b>C1 Release/ Image Stabilizer</b>	
S-AF Release Priority	505
C-AF Release Priority	505
 L Settings	155, 506
 H Settings	155, 507
Flicker reduction	190, 509
<b>C2 Release/ Image Stabilizer</b>	
 Image Stabilizer	176, 510
 Image Stabilization	174, 511
Half Way RIs With IS	178, 511
Lens I.S. Priority	512

Feature	
<b>D1</b> Disp/●/)/PC	
Control Settings	513
/Info Settings	515
Picture Mode Settings	520
/ Settings	520
Multi Function Settings	521
<b>D2</b> Disp/●/)/PC	
Live View Boost	200, 521
Art LV Mode	522
Frame Rate	175, 522
LV Close Up Settings	139, 523
Default Setting	523
Settings	524
<b>D3</b> Disp/●/)/PC	
Grid Settings	524
Peaking Settings	525
Histogram Settings	526
Mode Guide	526
Selfie Assist	527
<b>D4</b> Disp/●/)/PC	
●/)	527
HDMI	434, 528, 627
USB Mode	529
<b>E1</b> Exp/ISO/BULB/	
EV Step	530
ISO Step	530
ISO-Auto Set	183, 531
ISO-Auto	185, 531
Noise Filter	532
Low ISO Processing	532
Noise Reduct.	533

Feature	
<b>E2</b> Exp/ISO/BULB/	
Bulb/Time Timer	533
Bulb/Time Monitor	534
Live Bulb	534
Live Time	535
Composite Settings	110, 535
Flicker Scan	536
<b>E3</b> Exp/ISO/BULB/	
Metering	186, 536
AEL Metering	537
[∞] Spot Metering	537
Exposure Shift	538
<b>F</b> Custom	
X-Sync.	260, 539
Slow Limit	261, 539
+	540
+WB	540
RC Mode	541
<b>G</b> /WB/Color	
Set	81, 542
Pixel Count	82, 543
Shading Comp.	543
WB	544
All WB	545
WB Auto Keep Warm Color	205
Color Space	232

Feature	
<b>H1</b> Record/Erase	
Card Slot Settings	547
File Name	548
Edit Filename	548
dpi Settings	549
Copyright Settings	549
Lens Info Settings	550
<b>H2</b> Record/Erase	
Quick Erase	551
RAW+JPEG Erase	551
Priority Set	552
<b>I</b> EVF	
EVF Auto Switch	85, 328, 553
EVF Adjust	553
EVF Style	554
 Info Settings	555
EVF Grid Settings	556
 Half Way Level	556
S-OVF	89, 557
<b>J1</b>  Utility	
Pixel Mapping	558, 633
Press-and-hold Time	558
Level Adjust	559
Touchscreen Settings	559
Menu Recall	560
Fisheye Compensation	250, 560

Feature	
<b>J2</b>  Utility	
Battery Settings	561
Backlit LCD	561
Sleep	562
Auto Power Off	562
Quick Sleep Mode	563
<b>J3</b>  Utility	
Record GPS location	570
GPS Priority	564, 579
Elevation/Temperature	565, 578
Field Sensor Logger	565, 571
Certification	566
<b>↑</b> Setup Menu	
Card Setup	38, 276, 445, 454
 Settings	455
 	455
	456
Rec View	90, 456
Wi-Fi/Bluetooth Settings	457, 586, 607
Firmware	457
My Menu	477

# Parts of the Camera

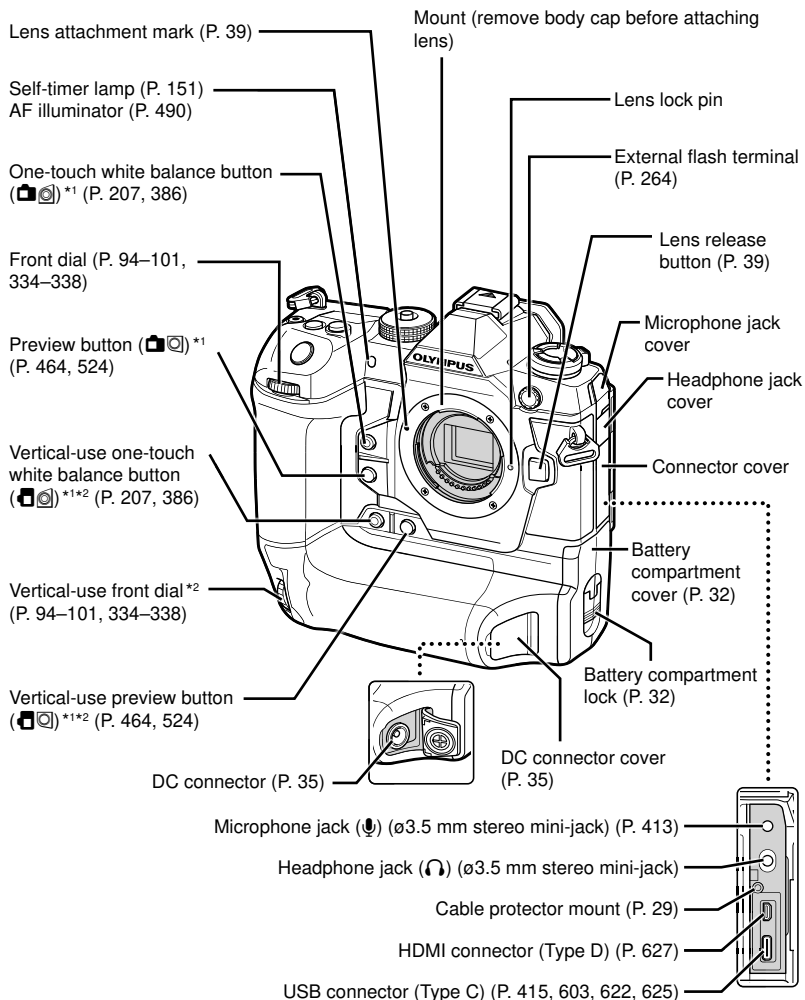

\*1 Can be assigned other roles. “Assigning Roles to Buttons (📷 Button Function)” (P. 463), “Assigning Roles to Buttons (📷 Button Function)” (P. 417)

\*2 Used when the camera is rotated 90° to shoot pictures in portrait (“tall”) orientation. Performs the same function as the standard (landscape or “wide”) orientation equivalent.



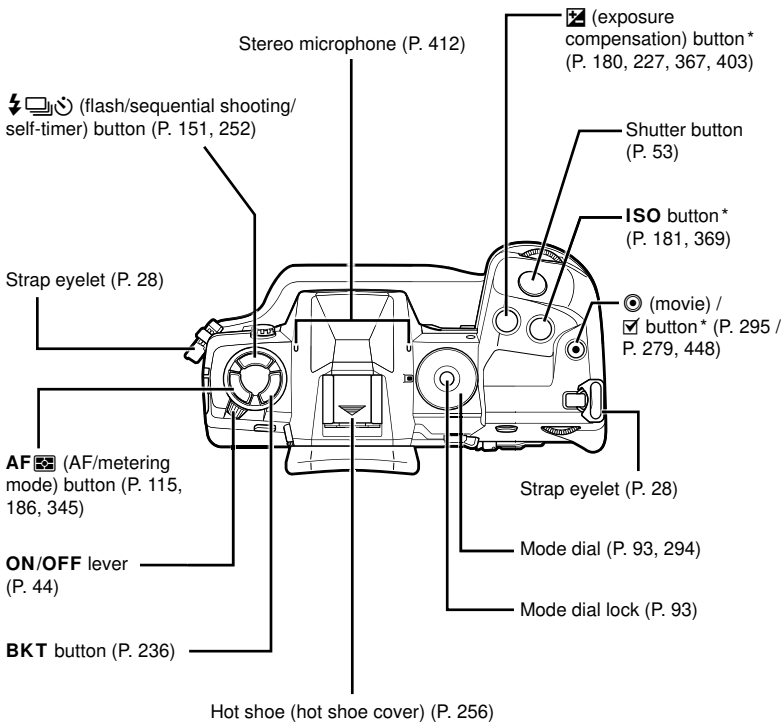

\* Can be assigned other roles. "Assigning Roles to Buttons (📷 Button Function)" (P. 463), "Assigning Roles to Buttons (🔧 Button Function)" (P. 417)

**AEL/AFL /  (protect) button\*1**  
(P. 141, 188, 373 / P. 270, 439)

**Fn lever** (P. 94–102, 334–338, 426, 475)

**Fn button\*1** (P. 417, 463)

**Lock lever** (P. 503)



**WB (white balance) /  (share) button\*1**  
(P. 202, 380 / P. 277, 446)

**CARD (card select) button**  
(P. 75, 318)

** (erase) button**  
(P. 275, 444)

**MENU button**  
(P. 66, 314)



** (playback) button** (P. 56, 300)

**Vertical-use multi selector (/ )<sup>\*2\*4</sup>**  
(P. 120, 123, 137, 349, 352, 410)

**Vertical-use AEL/AFL /  (protect) button<sup>\*1\*2</sup>**  
(P. 141, 188, 373 / P. 270, 439)

**Vertical-use rear dial<sup>\*2</sup>**  
(P. 94–101, 334–338)





**Rear dial** (P. 94–101, 334–338)

**Multi selector (/ )<sup>\*4</sup>**  
(P. 120, 123, 137, 349, 352, 410)

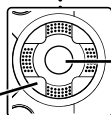

**INFO button** (P. 84, 265, 436)

**Card access lamp**









**Arrow pad (   )<sup>\*3</sup>**  
(P. 56, 300)

**OK button** (P. 56, 62, 66, 300)

\*1 Can be assigned other roles.  “Assigning Roles to Buttons ( Button Function)” (P. 463), “Assigning Roles to Buttons ( Button Function)” (P. 417)

\*2 Used when the camera is rotated 90° to shoot pictures in portrait (“tall”) orientation. Performs the same function as the standard (landscape or “wide”) orientation equivalent.

\*3 The  and  positions on the arrow pad can be assigned other roles.  “Assigning Roles to Buttons ( Button Function)” (P. 463), “Assigning Roles to Buttons ( Button Function)” (P. 417)

\*4 The multi selector is designed to be used in two ways. You can place a finger lightly on the multi selector and pivot it in the desired direction (). You can also press down on the center of the multi selector much as you would a button ().

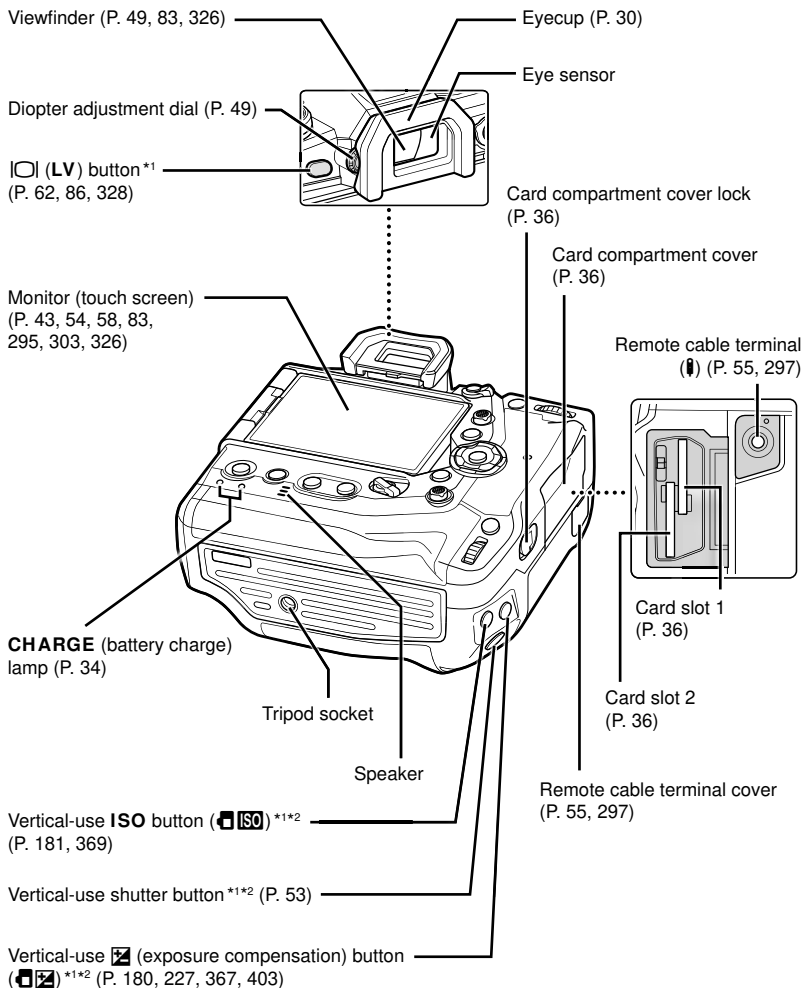

\*1 Can be assigned other roles. "Assigning Roles to Buttons ( Button Function)" (P. 463), "Assigning Roles to Buttons ( Button Function)" (P. 417)

\*2 Used when the camera is rotated 90° to shoot pictures in portrait ("tall") orientation. Performs the same function as the standard (landscape or "wide") orientation equivalent.

# Package Contents

At purchase, the package contains the camera and the following accessories. Contact your retailer should you discover anything damaged or missing.

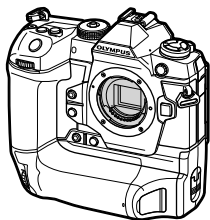

Camera



Body cap\*1



EP-17 eyecup\*1

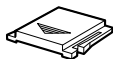

Hot shoe cover\*1

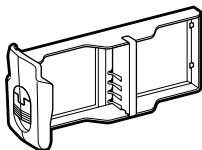

Battery cartridge\*1

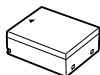

BLH-1 rechargeable lithium-ion battery\*2

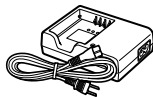

BCH-1 charger for lithium-ion batteries\*2



CC-1 cable clip



CP-1 cable protector

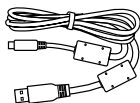

CB-USB11 USB cable



Strap



Basic Manual

- Warranty Card

\*1 The body cap, eyecup, hot shoe cover, and battery cartridge ship attached to or inserted in the camera.

\*2 The camera comes with two rechargeable batteries and two battery chargers.

# Before You Begin

## **Read and Follow Safety Precautions**

To prevent incorrect operation resulting in fire or other damage to property or harm to yourself or to others, read “8 SAFETY PRECAUTIONS” (P. 663) in its entirety before using the camera.

While using the camera, consult this manual to ensure safe and correct operation. Be sure to keep the manual in a safe place once it is read.

Olympus will not be held liable for violations of local regulations arising from use of this product outside the country or region of purchase.

- Use of these features outside the country or region of purchase may violate local wireless regulations; be sure to check with local authorities before use. Olympus will not be held liable for the user's failure to comply with local regulations.

## **Wireless LAN, Bluetooth®, and GPS**

The camera features built-in wireless LAN, **Bluetooth®**, and GPS. Use of these features outside the country or region of purchase may violate local wireless regulations; be sure to check with local authorities before use. Olympus will not be held liable for the user's failure to comply with local regulations.

Disable wireless LAN, **Bluetooth®**, and GPS in areas where their use is prohibited.

 “5 Using Field Sensor Data” (P. 567), “6 Connecting the Camera to External Devices” (P. 581)

## **■ User Registration**

Visit the OLYMPUS website for information on registering your OLYMPUS products.



# 1 **Getting Ready**

---

Read this chapter whether you are taking photographs or filming movies.

## Attaching the Strap

- 1** Before attaching the strap, remove the end from the keeper loop and loosen the strap as shown.

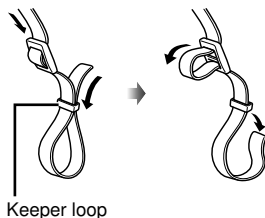

- 2** Pass the end of the strap through the strap eyelet and back through the keeper loop.



- 3** Pass the end of the strap through the buckle and tighten as shown.

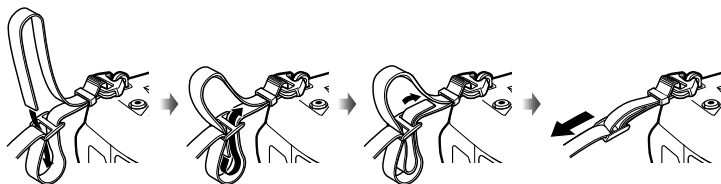

- Attach the other end of the strap to the other eyelet.
- After attaching the strap, pull on it firmly to ensure that it will not come loose.



## Attaching Cable Protectors

Attach the supplied cable protectors when connecting the supplied USB and HDMI cables. This prevents accidental disconnection and damage to the connectors.

- 1 Mount the cable protector on the camera.

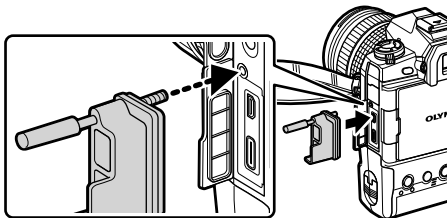

- 2 Tighten the screw.

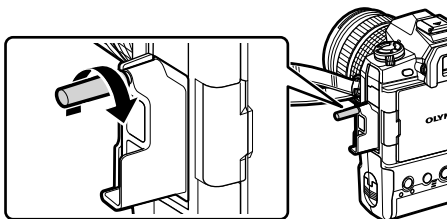

- 3 Clip the cable clip to the cable and attach the clip to the strap.
  - The clip attaches to the buckle.

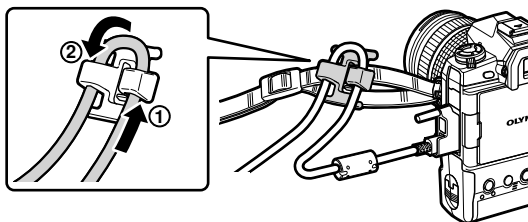

## Removing the Eyecup

The eyecup can be removed from the viewfinder eyepiece as shown.

- 1 Push up where shown.

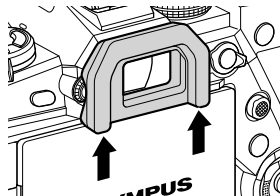

- 2 To re-attach the eyecup, slide it straight down the rails.

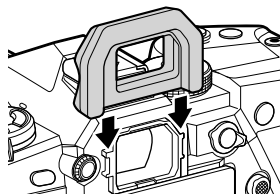

1

# Inserting and Removing Batteries

The camera can be used with up to two batteries at a time. It can also be used with a single battery.

## 1 Charge the batteries.

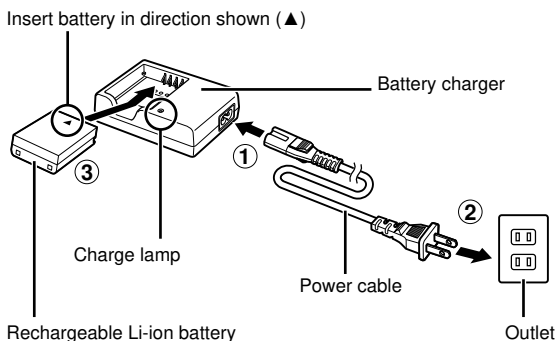

- Batteries charge in about 2 hours. Charge status is shown as follows:

Charge lamp	Charge status	
Flashes amber once per second	Charging	<50% charged
Flashes amber twice per second		50–79% charged
Flashes amber three times per second		80–99% charged
Lights green	Charging complete	
Flashes green five times per second	Charging error	

- Unplug the charger when charging is complete.
- Batteries inserted in the camera will charge when the camera is powered by an AC adapter or connecting to an external device via USB.  "Charging via USB" (P. 34), "Optional AC Adapters" (P. 35), "6-6 Powering the Camera via USB (USB Power Delivery)" (P. 625)

## 2 Confirm that the camera is off.

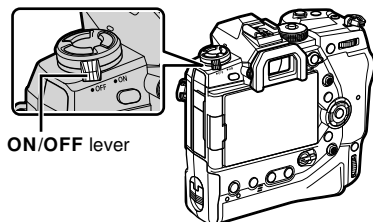

- 3** Unlatch the battery compartment cover and remove the battery cartridge.

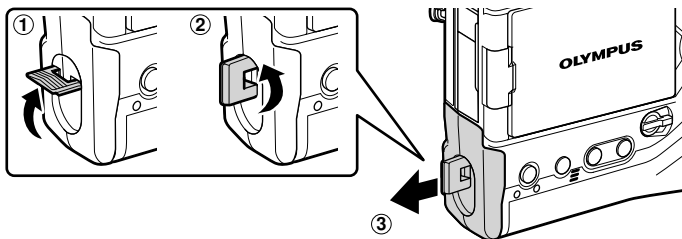

- 4** Insert the batteries into the battery cartridge.

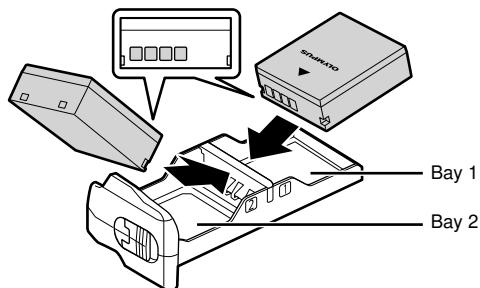

- 5** Insert the battery cartridge into the camera and latch the battery compartment cover.

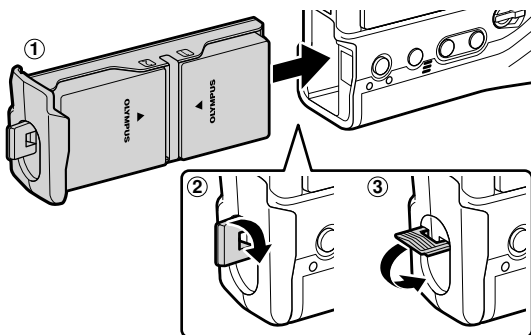

- We recommend that before using the camera for extended periods, you ready fully-charged spare batteries to swap in when the current batteries are exhausted.
- See “Batteries and Chargers” (P. 33).
- The order in which the batteries are used when two batteries are inserted can be chosen in the menus.  [Battery Settings] (P. 561)

## ■ Removing Batteries

To remove the batteries from the cartridge, slide them in toward the connectors and then lift them out.

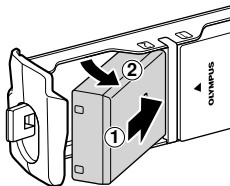

## Batteries and Chargers

- The camera uses two Olympus rechargeable Li-ion batteries. Use only genuine Olympus-brand batteries.
- Camera power consumption varies widely with the conditions of use.
- The following lead to greatly increased power consumption even when no photographs are taken or movies recorded:
  - Keeping the shutter button pressed halfway for repeated autofocus operations
  - Viewing pictures in the monitor for extended periods
  - Using Wi-Fi, **Bluetooth**<sup>®</sup>, or GPS
  - Leaving the camera connected to a computer
- The camera may turn off without warning when the batteries are exhausted.
- The batteries are not fully charged at purchase. Use a battery charger to charge batteries before first use.
- Remove the batteries before putting the camera into storage for periods of a month or more. Leaving the batteries in the camera for extended periods shortens their lives, potentially rendering them unusable.
- The supplied chargers take roughly two hours to charge the supplied batteries.
- Use only chargers specifically designated for use with the supplied batteries. Similarly, use only batteries specifically designated for use with the supplied chargers.
- Incompatible batteries may explode (or rupture) during use.
- Follow the instructions in "SAFETY PRECAUTIONS" (P. 664) when preparing used batteries for disposal.

## Using Your Charger Abroad

- The charger can be used in most home electrical sources within the range of 100 V to 240 V AC (50/60 Hz) around the world. However, depending on the country or area you are in, the AC wall outlet may be shaped differently and the charger may require a plug adapter to match the wall outlet.
- Do not use commercially available travel adapters as the charger may malfunction.

# Using External Power Sources

## Connecting via USB

Batteries inserted in the camera will charge when the camera is connected to a USB-AC adapter, computer, or other USB device via a USB cable. The batteries charge only when the camera is off.

Devices that conform to the USB Power Delivery (USB PD) standard can also be used to power the camera.  “6-6 Powering the Camera via USB (USB Power Delivery)” (P. 625)

### ■ Charging via USB

1

1 Confirm that the camera is off.



2 Connect the camera to the external device via USB.

- When attaching the USB cable, use the supplied cable protector and cable clip to prevent damage to the connectors.  “Attaching Cable Protectors” (P. 29)
- The **CHARGE** lamps light during charging. Charging times vary with the output of the USB device. The lamps each go out in turn as the batteries reach full charge.
- If only one battery is inserted, the camera will charge the battery in whichever bay is occupied.

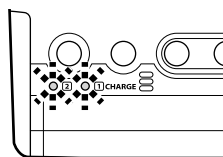
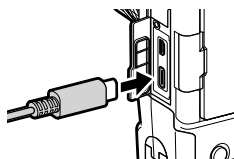

3 Charging ends when the camera is turned on.

- The batteries cannot be charged via USB when the camera is on.
- If a charging error occurs, the **CHARGE** lamps will blink. Disconnect and reconnect the USB cable.
- USB charging is available when the battery temperature is between 0 and 40 °C.



- If connected to both an AC adapter and a USB device, the camera will receive power only from the AC adapter.
- The supply of power ends when the batteries are charged. Disconnect and reconnect the USB cable to resume charging.
- The batteries will not charge while the camera is off if pictures are being uploaded to a smartphone via Wi-Fi (background auto upload).  “Connecting When the Camera Is Off (Power-off Standby)” (P. 590)

## ■ Powering the Camera via USB

The camera can be powered using mobile batteries or similar devices connected via USB. The devices must:

Standard: Conform to the USB Power Delivery (USB PD) standard

Output: Be rated for an output of 9 V 3 A, 15 V 2 A, or 15 V 3 A

For more information, see “6-6 Powering the Camera via USB (USB Power Delivery)” (P. 625).

## Optional AC Adapters

While inserted in the camera, batteries can be charged using an optional AC-5 AC adapter (on-board charging). The AC adapter can also be used to power the camera. When powered by an AC adapter, the camera can be used even if no batteries are inserted. Use only AC adapters designated for use with the camera. The power cable supplied with the AC adapter is not to be used with other devices.

1

1 Confirm that the camera is off.

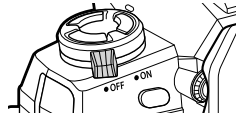

2 Open the DC connector cover.

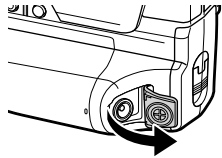

3 Connect the AC-5 by plugging the DC jack into the camera DC connector.

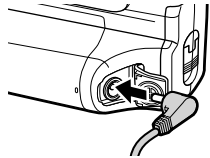

- The batteries will charge while the camera is off.
- Securely close the DC connector cover when the AC adapter is not in use.
- If batteries are inserted in the camera, the **CHARGE** lamps light while the batteries charge. The lamps each go out in turn as the batteries reach full charge.
- If only one battery is inserted, the camera will charge the battery in whichever bay is occupied.
- Charging via AC adapter is available when the battery temperature is between 0 and 40 °C.



- The batteries will not charge while the camera is off if pictures are being uploaded to a smartphone via Wi-Fi (background auto upload).  “Connecting When the Camera Is Off (Power-off Standby)” (P. 590)

# 1-1 Inserting Memory Cards

The camera uses third-party SD, SDHC, or SDXC memory cards conforming to the SD (Secure Digital) standard. Read “Memory Cards” (P. 37) before use.

- 1 Confirm that the camera is off.

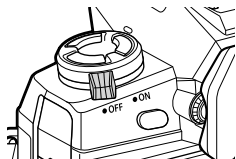

- 2 Rotate the card compartment cover lock as shown (1), (2) and open the card compartment cover (3).

- The camera has two card slots.

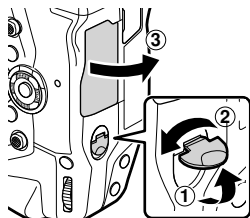

- 3 Slide the card in until it locks into place.

- Turn the camera off before inserting or removing memory cards.
- Do not attempt to forcibly insert cards that are damaged or deformed. Failure to observe this precaution could result in damage to the slots.

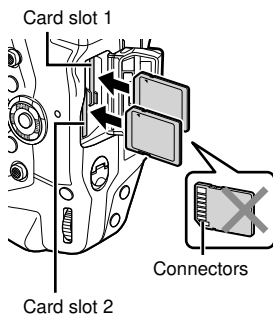

- 4 Close the card compartment cover.

- Press the cover closed until it clicks into place.
- Be sure the cover is closed before using the camera.

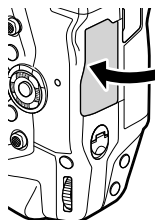

- Format memory cards in the camera before first use (P. 38).



## ■ Removing Memory Cards

Press the card to eject it. The card can then be removed by hand.

- Never remove batteries or memory cards while the card access lamp is lit or the memory card access indicator (P. 86, 88, 329, 330) is displayed.

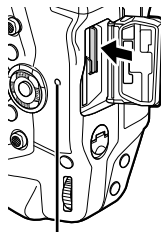

Card access lamp

## Using Two Memory Cards

When two memory cards are inserted, you can choose how each card is used according to your goals.  [Card Slot Settings] (P. 547)







- Record only to a selected card
- Record to a selected card until it is full, then record to the second card
- Record pictures with different sizes or compression ratios to different cards
- Record copies of each picture to both cards

For information on card role selection, see “2-3 Card-Related Settings” (P. 71).

## Memory Cards

This manual refers to storage devices as “memory cards”. The camera uses third-party SD, SDHC, or SDXC memory cards conforming to the SD (Secure Digital) standard. Visit the Olympus website for the latest information.



- Use a memory card with a Speed Class of 10 or better when recording movies.
- Use a memory card with a UHS-II or UHS-I Speed Class of 3 or better when:  
Recording movies with [4K] or [C4K] selected for   /Recording movies with [A-I] (All-Intra) selected for the   bit rate  
  (P. 321)
- Some data remain when memory cards are formatted or pictures are deleted. To protect your personal information when disposing of memory cards, destroy the card or take other steps to render the data unrecoverable.
- SD memory cards are equipped with a write-protect switch. Data cannot be written to the card when the switch is in the “LOCK” position. Returning the switch to its original position allows data to again be written to the card.



## Formatting Memory Cards (Card Setup)

Use the camera to format newly-purchased memory cards or cards that have been used in another camera, computer, or other device.

Formatting deletes all data from the card, protected pictures included. Confirm that the card does not contain important files before formatting.

When first turned on, the camera will display a message prompting you to configure basic settings; do not format the card until the initial setup process is complete.

☞ “1-5 Initial Setup” (P. 45)

**1** Press the **MENU** button to display the menus.

- For information on using the menus, see “Using the Menus” (P. 66).

**2** In the **Y** setup menu, highlight [Card Setup] and press the **OK** button.

- If two memory cards are inserted, one in Slot 1 and the other in Slot 2, [Select Card to Set Up] options will be displayed. Highlight the desired slot and press the **OK** button.
- If the card already contains data, a menu will be displayed. Highlight [Format] and press the **OK** button.

**3** Highlight [Yes] and press the **OK** button.

- The camera will format the card.

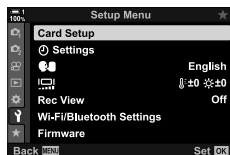

# 1-2 Attaching Lenses

- 1** Confirm that the camera is off.

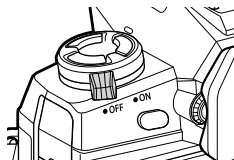

- 2** Remove the rear lens cap and the camera body cap.

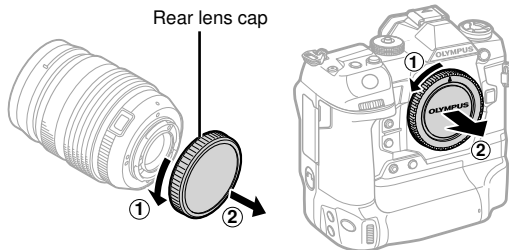

- 3** Align the (red) attachment mark on the lens with the (red) attachment mark on the camera body and insert the lens into the camera lens mount.

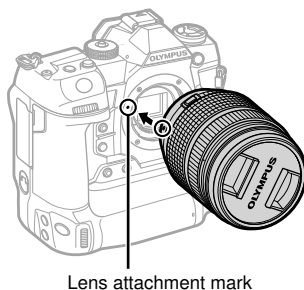

- 4** Rotate the lens as shown until it clicks into place.

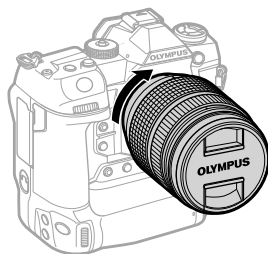

## 5 Remove the front lens cap.

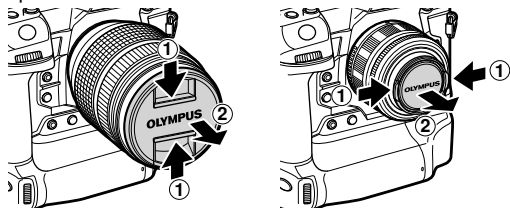

- Be careful not to press the lens release button while attaching the lens.
- Do not touch the camera's internal parts.

## Removing Lenses

1

### 1 Confirm that the camera is off.

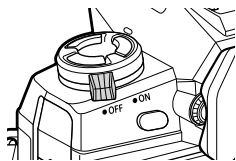

### 2 Hold the lens release button and rotate the lens as shown.

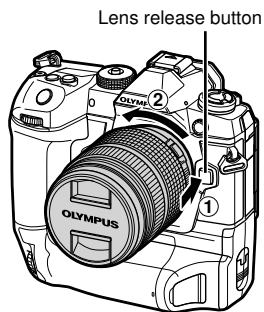

## MF Clutch Lenses

The “MF clutch” (manual focus clutch) mechanism on MF clutch lenses can be used to switch between auto and manual focus simply by repositioning the focus ring.

- Check the position of the MF clutch before shooting.
- Sliding the focus ring to the AF/MF position at the end of the lens selects autofocus, while sliding it to the MF position closer to the camera body selects manual focus, regardless of the focus mode chosen with the camera.

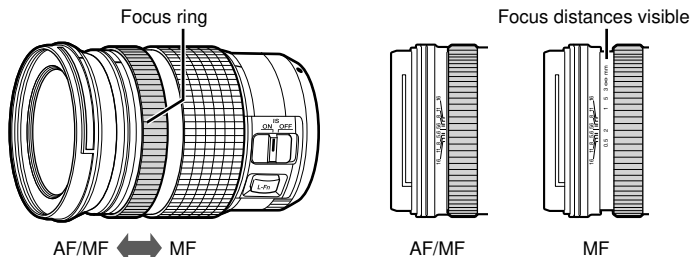

- Selecting [MF] or [PreMF] for focus mode on the camera disables autofocus even when the focus ring is in the AF/MF position.

## Interchangeable Lenses



The camera can be used with interchangeable lenses designated exclusively for use with the “Micro Four Thirds” system, which can be identified by the presence of the M.ZUIKO DIGITAL trademark or the logo shown at right.

Four Thirds and OM system lenses can also be used. An adapter (available separately) is required.

- To prevent dust or other foreign matter entering the camera, keep the lens mount pointed down when the lens or body cap is removed.
- Do not remove the body cap or exchange lenses in dusty locations.
- Do not point the lens at the sun while it is mounted on the camera. Sunlight focused through the lens could cause product malfunction or fire.
- Be careful not to lose the body cap or rear lens cap.
- To prevent dust entering the camera, attach the body cap when a lens is not in place.

### Lens Compatibility

Lens	Camera	Compatible	AF	Metering
Micro Four Thirds system lens	Micro Four Thirds system camera	Yes	Yes	Yes
Four Thirds system lens		Mount adapter required	Yes *1	Yes
OM system lens			No	Yes *2

\*1 Not available during movie recording.

\*2 Does not produce accurate results.

## 1-3 Using the Monitor

Rotate the monitor for ease of viewing. The angle of the monitor can be adjusted according to conditions at the time of shooting.

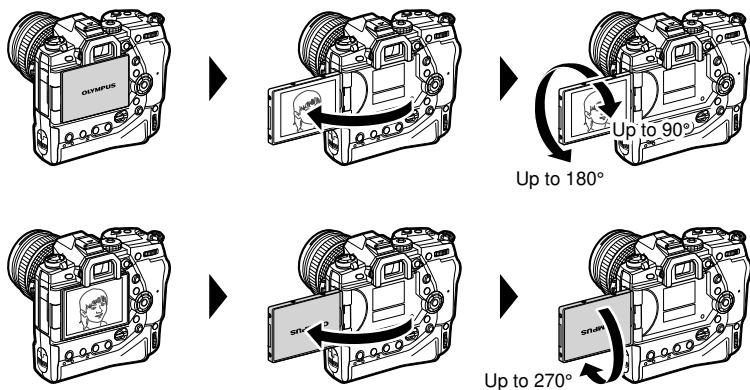

1

- Gently rotate the monitor within its range of motion. Attempting to rotate the monitor beyond the limits shown below could damage the connectors.

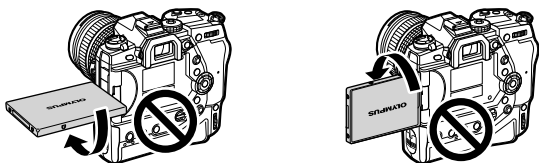

- The camera can be configured to display a mirror image of the view through the lens or automatically zoom power zoom lenses all the way out when the monitor is rotated for self portraits.  [Selfie Assist] (P. 527)

## 1-4 Turning the Camera On

Rotate the **ON/OFF** lever to **ON**.

- The camera will turn on and the monitor will light.
- To turn the camera off, rotate the lever to **OFF**.

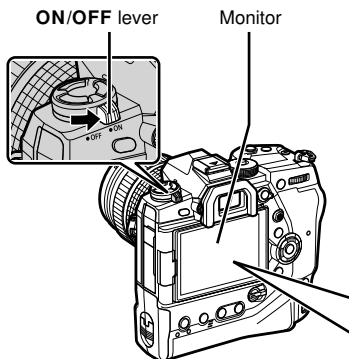

### The Battery Level Display

The level of the current battery and the number of the bay in which it is inserted are shown in the display. The battery level is shown in 10 increments. The indicator flashes red when the level reaches 10%.

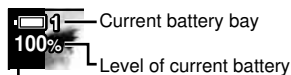

- The camera may require additional time to power on when [On] (enabled) is selected for [Wi-Fi/Bluetooth Settings] > [Power-off Standby]. "Connecting When the Camera Is Off (Power-off Standby)" (P. 590)

## Sleep Mode

If no controls are used for a set period, the camera will automatically enter suspend operation to reduce the drain on the batteries. This is referred to as "sleep mode".

- When the camera enters sleep mode, the monitor will turn off and operation will be suspended. Pressing the shutter or button reactivates the camera.
- If no operations are performed for a set period after the camera enters sleep mode, the camera will turn off automatically. The camera can be reactivated by turning it on again.
- The camera may require additional time to recover from sleep mode when [On] (enabled) is selected for [Wi-Fi/Bluetooth Settings] > [Power-off Standby]. "Connecting When the Camera Is Off (Power-off Standby)" (P. 590)
- The delay before the camera goes to sleep or turns off automatically can be selected in the custom menu. At default settings, the camera will go to sleep after one minute and turn off automatically after four hours. [Sleep] (P. 562), [Auto Power Off] (P. 562)



# 1-5 Initial Setup

When first turned on, the camera will prompt you to pick a language and set the clock.

- The current time and date are saved with each picture taken.
- File names include the current date. Be sure to set the clock before using the camera. Some features are only available if the clock is set.

- 1** When the camera displays a setup dialog prompting you to select a language, press the **OK** button.

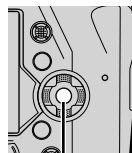
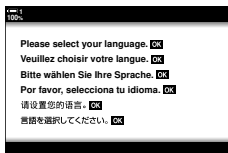

OK button

- 2** Highlight the desired language using the arrow pad ( $\Delta \nabla \triangleleft \triangleright$ ) or front or rear dial.

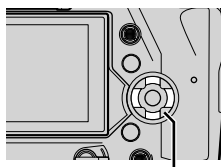

Arrow pad

- The language-selection dialog has two pages of options. Highlight the desired language using the  $\Delta \nabla \triangleleft \triangleright$  buttons or front or rear dial.



### 3 After highlighting the desired language, press the **OK** button.

- If you press the shutter button before pressing the **OK** button, the camera will exit to shooting mode and no language will be selected. The language selection dialog can be displayed by turning the camera off and then on again, after which you can repeat the process from Step 1.
- The language can be changed at any time from the setup menu. [ ] (P. 455)



### 4 Choose the time and date.

- Highlight items using the buttons.
- Edit the highlighted item using the buttons.
- The clock can be adjusted at any time from the setup menu. [ Settings ] (P. 455)
- Press the **OK** button when settings are complete.

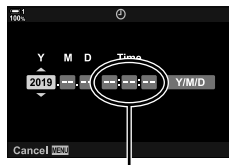

24 hour clock

### 5 Highlight a time zone using the buttons and press the **OK** button.

- Press the **INFO** button to enable or disable daylight saving time.

### 6 Press the **OK** button to set the clock.

- Leaving the camera with the batteries removed may cause the clock to be reset.
- Choose the frame rate as necessary before recording movies. [ ] (P. 321)



- The clock can be automatically updated via GPS. "Correcting the Clock Using GPS" (P. 48)

# What to Do If You Can't Read the Display

If you see unfamiliar characters or words in other languages, you may not have selected the language you intended. Follow the steps below to choose another language.

- 1 Press the **MENU** button to view the menus.

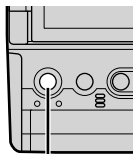

MENU button

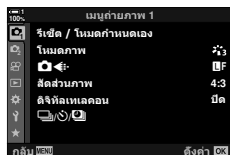

- 2 Highlight the **⚙** (setup) tab using **△**/**▽** on the arrow pad and press the **OK** button.

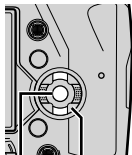

Arrow pad

OK button

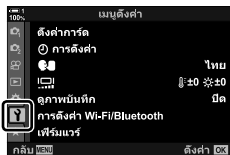

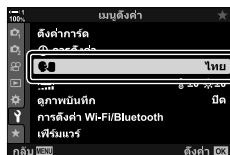

- 3 Highlight [ **🇹🇭** ] using the **△**/**▽** buttons and press the **OK** button.



- 4 Highlight the desired language using the **△**/**▽**/**◀**/**▶** buttons and press the **OK** button.



## Correcting the Clock Using GPS

GPS can be used to correct the clock. Time and date information acquired via GPS are used to automatically correct the clock while the camera is on. The time zone must be selected in advance using the [Time Zone] option.  “Choosing a Language (  Language)” (P. 455)

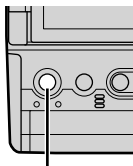

- 1 Press the **MENU** button to view the menus.



MENU button



1

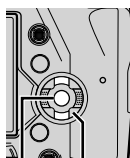

- 2 Highlight the  (setup) tab using   on the arrow pad and press the **OK** button.



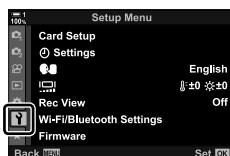

Arrow pad

OK button



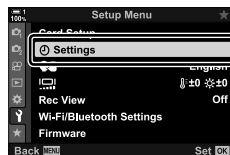

- 3 Highlight [ Settings] using the   buttons and press the **OK** button.

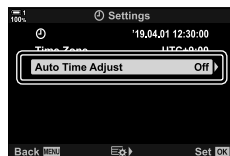

- 4 Highlight [Auto Time Adjust] using the   buttons and press the **OK** button.



- 5 Highlight [On] using the   buttons and press the **OK** button.

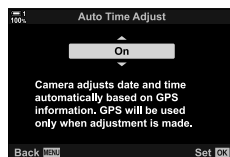

## 1-6 Focusing the Viewfinder

At default settings, putting your eye to the viewfinder automatically turns the display on. Adjust viewfinder diopter if the display is not in focus.

- Rotate the diopter adjustment dial until the display in the viewfinder is in focus.
- The viewfinder may turn off while you adjust the angle of the monitor.
- The camera can be configured not to switch automatically between the monitor and viewfinder displays.  [EVF Auto Switch] (P. 553)

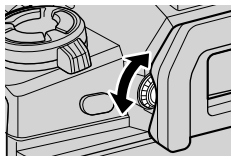



# 2

## Taking and Viewing Photographs

---

Read this chapter for information on using the camera to take photographs. This chapter also covers the features you'll use when shooting and viewing photos.

## 2-1 Basic Photography and Playback

Read this section for information on basic photography and playback that will get you started using your camera right away. It also provides basic information on such topics as using the touch screen and switching memory cards.

2

### Taking Photos

#### Holding the Camera

Be careful that your fingers or other objects, such as the camera strap, do not obstruct the lens or AF-assist illuminator.

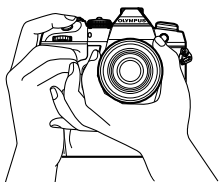

Landscape (wide) orientation

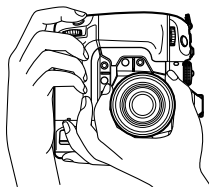

Portrait (tall) orientation

- To prevent unintended operation, you can lock camera controls using the lock lever. You can choose which controls are locked.  [C-LOCK Settings] (P. 503)



## Taking Photos with the Shutter Button

Frame your subject in the viewfinder and take photos with the shutter button. Compose the shot to position the AF frame over your subject and focus before shooting.

### 1 Focus.

- Press the shutter button a short distance to the first stop (referred to as “pressing the shutter button halfway”). The in-focus indicator (●) will be displayed and the AF target for the area in focus will light.

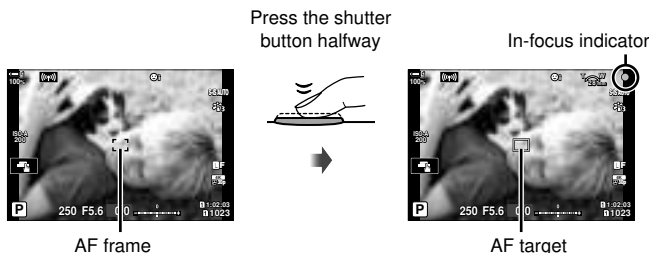

- If the camera is unable to focus, the in-focus indicator will flash.
- The AF frame varies with the option chosen for AF-target mode. AF-target mode defaults to [ · ] (single target). The area covered by the AF target can be chosen in the AF-target selection display (P. 120). The AF frame is not displayed when  $\overline{\text{ALL}}$  (all targets) is chosen for AF-target mode.

### 2 Take the picture.

- Starting from the halfway point, press the shutter button the rest of the way down (“press the shutter button all the way down”).
- The shutter will be released and a photograph will be taken.

2

#### Pressing the Shutter Button Halfway or All the Way Down

The camera features a two-position shutter button. Pressing the button a short distance to the first position is referred to as “pressing the shutter button halfway”, while pressing it further down to the second position is referred to as “pressing the shutter button all the way down”.



- The photograph will be displayed for viewing in the monitor. You can disable the display of pictures after shooting or choose how long they are displayed.  $\overline{\text{Rec View}}$  [Rec View] (P. 90).
- Press the  $\overline{\text{Play}}$  (playback) button to view photos as they are saved to the memory card after shooting. You can check pictures even as the camera records large numbers of photos taken during burst photography or the like. Some playback options are not available.



## Taking Photos with Touch Controls

Frame a shot in the monitor and touch your subject in the display to focus and shoot. You can also use touch controls to position or zoom in on the AF target.

### ■ Touch Shutter Options

Tap  in the monitor to choose an option.

- The option selected changes each time you tap .

	Tap your subject to focus and take a picture.
	Touch shutter disabled.
	Tap to position the AF target and focus. You can resize or position the AF frame with your fingers. Press the shutter button to shoot.

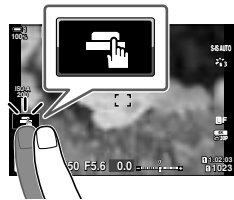



### ■ Focus Zoom ()

**1** Tap your subject.

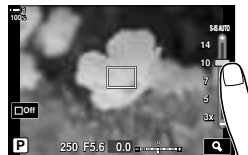
- An AF target is displayed.
- Adjust the size of the target using the slider.
- To hide the target, tap .



**2** After adjusting the size of the target with the slider, tap  to zoom the target in.

- While zoom is in effect, you can slide your finger to scroll the display.
- To exit zoom, tap .

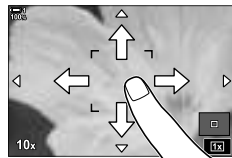

- Touch controls are not available in some circumstances, including:
  - In the one-touch WB white balance metering display
  - While camera buttons or dials are in use
- Do not touch the display with your fingernails or pointed objects.
- Touch controls may not function as expected if you are wearing gloves or the monitor is covered with a protective sheet.



- Touch controls can be disabled.  [Touchscreen Settings] (P. 559)

## Remote Photography

You can use remote photography when photographing night scenes, during macro photography, or in other situations in which you wish to avoid camera blur caused by operating the shutter button. You can either use an optional RM-CB2 remote cable or take pictures remotely via a wireless connection using the OI.Share smartphone app.

### ■ Using a Remote Cable

Open the remote cable terminal cover and connect the remote cable.

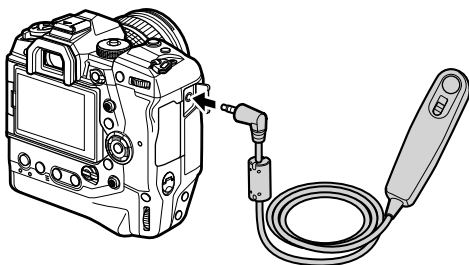





### ■ Using OI.Share

You will need to configure the camera for connection to a smartphone. Install OI.Share on your smartphone before proceeding. 📱 “6-2 Connecting to Smartphones via Wi-Fi” (P. 584)

# Viewing Photographs

View photographs stored on the memory cards.

## 1 Press the button.

- The most recent picture will be displayed (single-frame playback).
- Use the multi selector () , front dial () , or   on the arrow pad to view other pictures.
- To return to the shooting display, press the shutter button halfway.



Single-frame playback

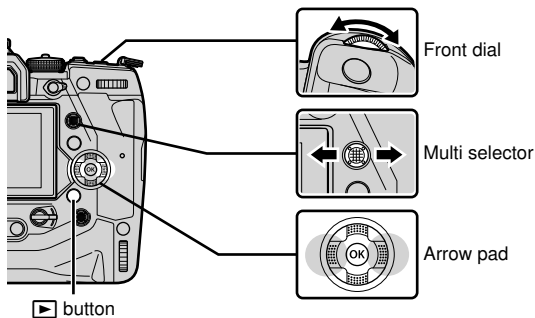

View previous picture   View next picture

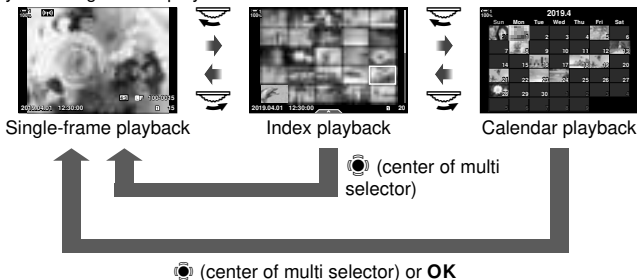

## 2 Rotate the rear dial () to cycle through the playback displays.

- Cycle through the displays as follows:



- To return to single-frame playback from the index playback display, press the multi selector.
- To return to single-frame playback from the calendar playback display, press the **OK** button.
- Use /Info Settings] (P. 515) >  Settings] in  Custom Menu **D1** to choose the number of pictures shown in each page of the index playback display.

- 3 Press the shutter button halfway to end playback and exit to the shooting display.



- Press the  (playback) button to view photos as they are saved to the memory card after shooting. You can check pictures even as the camera records large numbers of photos taken during burst photography or the like. Some playback options are not available.

## Choosing a Memory Card

If two memory cards are inserted, you can switch from viewing pictures on one card to viewing pictures on the other while playback is in progress.

- 1 Press the  button to start playback.



- 2 Hold the **CARD** (card select) button and rotate the front or rear dial to choose a card slot, and then release the **CARD** button.

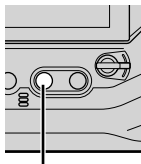

CARD button

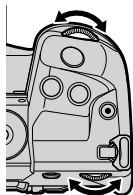

+



- The number of the slot currently selected is shown in the playback display.



Current slot

- The camera automatically switches between the last photo on the first memory card and the first photo on the second card.





- To choose the card selected for playback when the  button is pressed, use [Card Slot Settings] (P. 547)
- You can also switch cards using the  button. Hold the  button and rotate the front or rear dial to switch cards while playback is in progress.

2

## Adjusting Volume

Adjust playback volume for sound recorded with pictures.

You can also add audio to photos after shooting.   (P. 281)



- 1 Press the  button to start playback.
- 2 Press  $\Delta$  or  $\nabla$  on the arrow pad.
  - Press  $\Delta$  to increase the volume,  $\nabla$  to decrease.



## Playback Using Touch Controls

Touch controls can be used to zoom in on and scroll pictures and to page through pictures during playback.

### ■ Single-Frame Playback

- 1 Press the  button to start playback.
- 2 Touch the monitor and slide your finger left or right.
  - Flick left to view the next picture, right to view the previous picture.
- 3 Tap the monitor again.
  - A slider and a  icon will be displayed.
- 4 Drag the slider up or down.
  - Drag the slider up to zoom in, down to zoom out.
- 5 When the picture is zoomed in, you can slide a finger over the display to scroll.
  - Lightly tap twice to zoom in on a selected location. Repeat the process to zoom out.
  - Touch controls are also available during index playback. Swipe up or down to change pages.



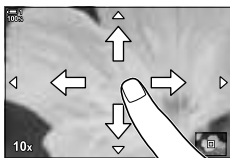

Slider



## 2-2 Shooting Settings

The camera offers many photography-related functions. Depending on how often you use them, you can access settings via buttons, icons in the display, or menus that can be used for detailed adjustments.





Method	Description
Direct buttons	Adjust settings directly using buttons, including those listed below. Commonly-used functions are assigned to buttons for quick access during viewfinder photography. <ul style="list-style-type: none"><li>• The <b>AF</b> , <b>WB</b>, and   buttons</li></ul>
LV super control panel/ super control panel	Choose from a list of settings showing current camera status. You can also view current camera settings.
Live controls	Adjust settings while viewing your subject in the display.
Menus	Adjust settings from menus displayed in the monitor.

## Direct Buttons

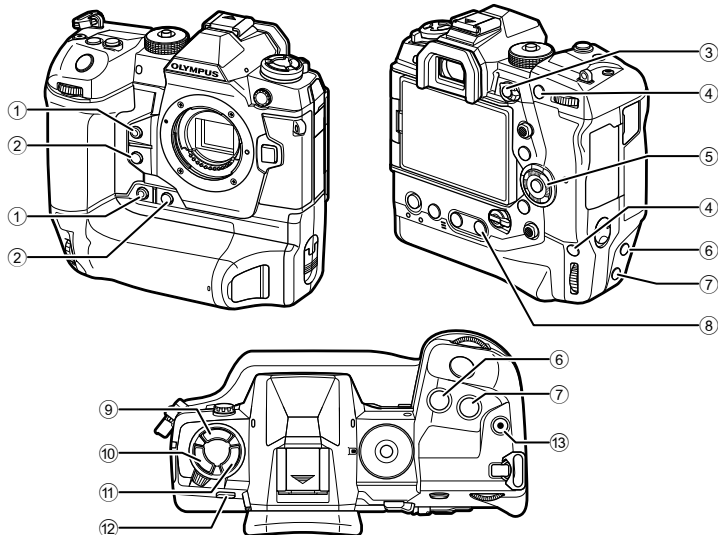



Frequently-used photographic functions are assigned to buttons. These are referred to as “direct buttons”. Included are the buttons listed below, which can be used for basic shooting settings.

The camera features buttons for shots framed in (“wide”) orientation and others that make the camera easier to use when rotated to take pictures in portrait (“tall”) orientation. Unless otherwise noted, either can be used.



Direct button	Assigned function	
①  button*	One-touch white balance	207, 386
②  button*	Preview	464
③ <b>Fn</b> button	[::] (AF-target selection)	123
④ <b>AEL/AFL</b> button*	AEL/AFL	141, 188
⑤ Arrow pad	[::] (AF-target selection)	123
⑥  button*	Exposure compensation	180, 227
⑦ <b>ISO</b> button*	ISO sensitivity	181
⑧ <b>WB</b> button	White balance	202



Direct button	Assigned function	
⑨  button	Flash/sequential shooting/self-timer	151
⑩ <b>AF</b>  button	AF/metering mode	115, 186
⑪ <b>BKT</b> button	Bracketing	236
⑫  (LV) button	Display (monitor/viewfinder) selection	62, 83
⑬  button	Movie recording	294

\* Also assigned to a button for use when the camera is rotated to take shots in portrait ("tall") orientation.  "Parts of the Camera" (P. 20)

## 1 Press the desired button.

- The camera will display options for the chosen function.



Options

## 2 Rotate the front or rear dial to select the desired option.

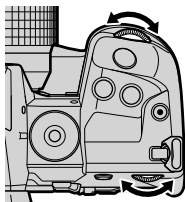





- Additional options may be available for some functions. In this case options can be displayed by pressing the **INFO** button.
- You can also choose a setting by holding the button and rotating the front or rear dial. Release the button to exit the option list and return to the shooting display.



2



- To prevent unintended operation, you can lock camera controls using the lock lever. You can choose which controls are locked.  [C-LOCK Settings] (P. 503)
- Buttons can be assigned different roles.   Custom Menu **B1**  Button Function] (P. 463)

## The Super Control/LV Super Control Panel

The super control/LV super control panel lists shooting settings and their current values. Use the LV super control panel when framing shots in the monitor (“live view”), the super control panel when framing shots in the viewfinder.

The instructions in this manual are for the LV super control panel.

- Pressing the  (LV) button during live view enables viewfinder photography and displays the LV super control panel in the monitor.



Live view photography

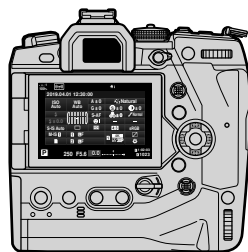
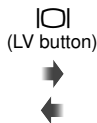

Viewfinder photography (monitor turns off while viewfinder is on)

### LV Super Control Panel (Live View Photography)

To display the LV super control panel in the monitor, press the **OK** button during live view.



OK



### Super Control Panel (Viewfinder Photography)

When you frame subjects in the viewfinder, the super LV control panel will be displayed in the monitor at all times.



OK

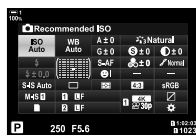

## ■ Using the Super Control/LV Super Control Panel

- 1 Press the **OK** button.
  - If you press the button during live view, the LV super control panel will be displayed in the monitor.
  - The last setting used will be highlighted.

Cursor



- 2 Rotate the rear dial or tap to select a setting in display.

- The selected setting will be highlighted.
- You can also highlight settings using the multi selector or arrow pad (△ ▽ ◀ ▶).

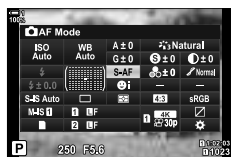
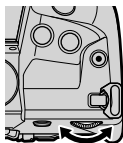

- 3 Rotate the front dial to change the highlighted setting.

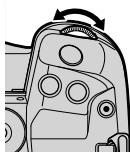

- 4 Press the shutter button halfway to accept current settings and exit the LV super control panel.
  - If you are using the super control panel, the cursor will vanish and setting will end.

2

## Additional Options

Pressing the **OK** button in Step 2 displays options for the highlighted setting. In some cases, additional options can be viewed by pressing the **INFO** button.

**INFO** button

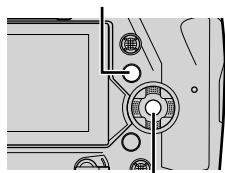

**OK** button

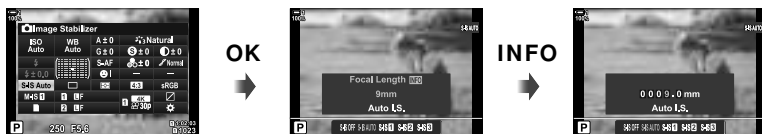

[📷 Image Stabilizer]

- Touch controls can be used in place of the **OK** button. Lightly tap the desired setting twice to display options.

## ■ Settings Available in the Super Control/LV Super Control Panel

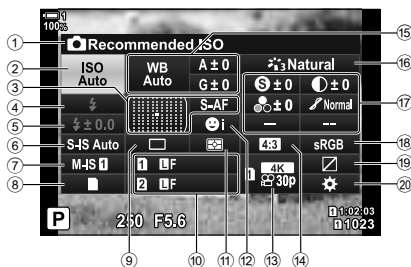

- |   |   |
|---|---|
| ① Option currently selected                                   | ⑫ Picture mode..... P. 215                |
| ② ISO sensitivity ..... P. 181                                | ⑬ Sharpness..... P. 220                   |
| ③  AF mode ..... P. 115                                       | ⑭ Contrast ..... P. 221                   |
| AF-target mode..... P. 120                                    | ⑮ Saturation ..... P. 222                 |
| ④ Flash mode..... P. 254                                      | Tone gradation..... P. 223                |
| ⑤ Flash compensation..... P. 259                              | Color filter ..... P. 224                 |
| Manual flash output ..... P. 257                              | Tint..... P. 225                          |
| ⑥  image stabilization ..... P. 176                           | Effect..... P. 226                        |
| ⑦  image stabilization *1..... P. 376                         | Color *3..... P. 231                      |
| ⑧  storage options..... P. 72                                 | Color/Vivid *4..... P. 229                |
| ⑨ Drive mode (sequential shooting/<br>self-timer)..... P. 151 | Effect *5..... P. 226                     |
| ⑩  image quality ..... P. 78                                  | ⑯ Color space..... P. 232                 |
| ⑪ Metering mode..... P. 186                                   | ⑰ Highlight & shadow control ..... P. 227 |
| ⑫  face priority ..... P. 133                                 | ⑱ Control assignment..... P. 463          |
| ⑬  image quality *1 ..... P. 321, 339                         |   |
| ⑭ Aspect ratio..... P. 233                                    |   |
| ⑮  white balance ..... P. 202                                 |   |
| white balance compensation .... P. 206                        |   |
| color temperature *2 ..... P. 202                             |   |

\*1 Settings indicated by a “” (movie) icon are for movie recording. See “3 Shooting and Viewing Movies” (P. 293).

\*2 Displayed when CWB (custom white balance) is selected for white balance.

\*3 Displayed when “Partial Color” is selected.

\*4 Displayed when “Color Creator” is selected.

\*5 Displayed when an art filter is selected.

## Using the Menu

Items not listed in the control panels can be found in the menus, including items for adjusting shooting and playback settings and customizing the camera for ease of use.

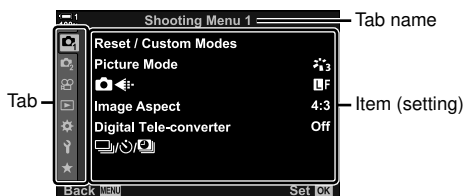

Tab	Tab name	Description
	<b>Shooting Menu 1</b>	Photography-related items. Ready the camera for shooting or access basic photo settings.
	<b>Shooting Menu 2</b>	Photography-related items. Adjust advanced photo settings.
	<b>Video Menu</b> *1	Items related to movie recording. Adjust basic and custom settings.
	<b>Playback Menu</b>	Playback- and retouch-related items.
	<b>Custom Menu</b>	Items for customizing the camera.
	<b>Setup Menu</b>	Items for setting the clock, choosing a language, and the like.
	<b>My Menu</b> *2	A customizable menu containing only items you select. "Creating a Personalized Menu (My Menu)" (P. 477)

\*1 The video menu is for movie recording. See "3 Shooting and Viewing Movies" (P. 293).

\*2 "My Menu" contains no items at shipment. Use "My Menu" to store and organize frequently-used items from other menus. Select items for addition to "My Menu" from the camera menus (P. 477).

- 1 Press the **MENU** button to display the menus.



- Tool tips are displayed for roughly 2 seconds after an item is highlighted. Press the **INFO** button to view or hide tool tips.

- 2 Highlight a tab using  $\Delta$   $\nabla$  on the arrow pad and press the **OK** button.

- Selecting the **\*** custom menu tab displays group tabs. Highlight a group tab using the  $\Delta$   $\nabla$  buttons and press the **OK** button to select.

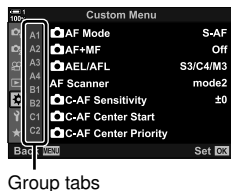

2

- 3 Highlight an item using the  $\Delta$   $\nabla$  buttons and press the **OK** button to view options.

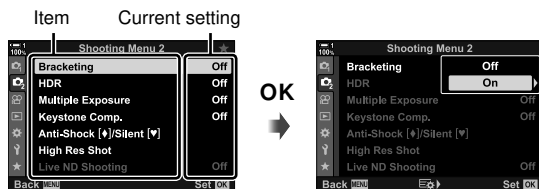

- 4 Highlight options using the  $\Delta$   $\nabla$  buttons and press the **OK** button to select.

- Press the **MENU** button repeatedly to exit the menus.
- Depending on camera status and settings, some items may be unavailable. Items that are not available are grayed out and cannot be selected.
- You can also navigate the menus using the multi selector or the front and rear dials in place of the arrow pad.

# Using Live Controls

Live controls are used to view and adjust settings during live view. The effects of the selected settings can be previewed in the live view display. Live controls are hidden by default. They can be accessed by enabling their display in the menus.



## ■ Viewing Live Controls

- 1 Press the **MENU** button to display the menus.
- 2 Highlight the **⚙️** (custom menu) tab using **△**/**▽** on the arrow pad and press the **OK** button.



- 3 Highlight the **D1** (Disp./**■**)/PC tab using the **△**/**▽** buttons and press the **OK** button.



- 4 Highlight [**📷** Control Settings] using the **△**/**▽** buttons and press the **OK** button.

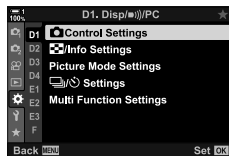

- 5 Highlight [Live Control] using the **△**/**▽** buttons and press the **OK** button.
  - A check (✓) will appear next to [Live Control].
  - To exit the menus, press the **MENU** button repeatedly or press the shutter button halfway.





- 6 Press the **OK** button during live view to display the LV super control panel.



- 7 Press the **INFO** button to switch to the live control display.



- Press the **INFO** button again to return to the LV super control panel.

## ■ Using Live Controls

- 1 Press the **OK** button to view live controls.
- To hide live controls, press the **OK** button again.

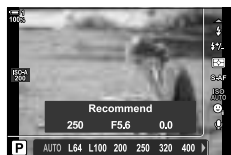

- 2 Highlight a setting using  $\Delta$   $\nabla$  on the arrow pad, then highlight an option using the  $\langle$   $\rangle$  buttons and press the **OK** button to select.

- Settings can also be adjusted using the dials. Use the rear dial to highlight a setting and the front dial to choose an option.
- The highlighted option will be selected automatically if no operations are performed for 8 seconds.



## ■ Available Live Controls



📷 image stabilization.....	P. 176	Flash mode.....	P. 254
Picture mode .....	P. 215	Flash compensation .....	P. 259
📷 white balance .....	P. 202	Metering mode.....	P. 186
Drive mode (sequential shooting/self-timer)		📷 AF mode .....	P. 115
.....	P. 151	📷 ISO sensitivity .....	P. 181
Aspect ratio.....	P. 233	👤 face priority .....	P. 133
📷 image quality .....	P. 78	🔊 movie audio* .....	P. 413
📷 image quality* .....	P. 321		

\* Available during movie recording. 📷 “3 Shooting and Viewing Movies” (P. 293)

## 2-3 Card-Related Settings









The camera can be used with up to two memory cards simultaneously. This section describes memory-card-related settings.

The menus and control panels offer items choosing how files are saved when two memory cards are inserted. For example, you can opt to save pictures of different types to different cards or automatically switch to the other card when one card fills.

For information on the cards that can be used for still photography, see “Memory Cards” (P. 37).

Choose how the camera stores pictures when two memory cards are inserted.

- This setting can be accessed via:
  - The LV super control panel (P. 73)
  - The menus (P. 73)
- The option selected for image quality may change when you change settings or remove a memory card and replace it with a card that has space available. Check image quality before shooting.

 <b>Standard</b>	Pictures are recorded to the memory card in the slot selected for  Save Slot] (P. 74). Shooting ends when the card is full.
 <b>Auto Switch</b>	Pictures are recorded to the memory card in the slot selected for  Save Slot] (P. 74). Pictures will be recorded to the remaining card when the card in the selected slot fills. This setting automatically reverts to [Standard] when only one memory card is inserted.
 <b>Dual Independent ↓</b>	Each picture is recorded twice, once in each of two different image quality formats. Choose an image quality for each slot (P. 78). Shooting ends when either card is full. Image quality is set separately for each slot; after changing the option selected, check the current image quality setting.
 <b>Dual Independent ↑</b>	Each picture is recorded twice, once in each of two different image quality formats. Choose an image quality for each slot (P. 78). Recording continues to the card in the remaining slot when either card fills. Image quality is set separately for each slot; after changing the option selected, check the current image quality setting.
 <b>Dual Same ↓</b>	Each picture is recorded twice, once to each card, using the option currently selected for image quality. Shooting ends when either card is full. This setting automatically reverts to [Standard] when only one memory card is inserted.
 <b>Dual Same ↑</b>	Each picture is recorded twice, once to each card, using the option currently selected for image quality. Recording continues to the card in the remaining slot when either card fills. This setting automatically reverts to [Standard] when only one memory card is inserted.

## ■ Access via the LV Super Control Panel

- 1 Highlight [📷 Save Settings] in the LV super control panel.
- 2 Rotate the front dial to choose a setting.
- 3 Press the shutter button halfway to exit the LV super control panel.

- Image quality may change depending on the option selected. Check image quality before shooting.

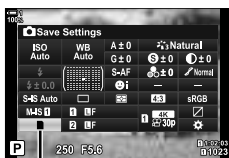

📷 save settings

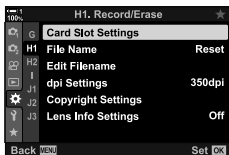

## ■ Menu Access

Choose a setting using [Card Slot Settings] (P. 547) > [📷 Save Settings] in ⚙ Custom Menu [H1].



2

MENU button ➔ ⚙ tab ➔ [H1] tab ➔ [Card Slot Settings] ➔ [📷 Save Settings] ➔ Press ▷ on the arrow pad to display options ➔ Use the △▽ buttons to choose an option

Choose the memory card used to store photos when two memory cards are inserted. Card selection is available when  (standard) or  (auto switch) is selected for [📷 Save Settings].

- This setting can be accessed via:
  - The LV super control panel
  - The menus

## ■ Access via the LV Super Control Panel

- 1 Highlight [📷 Save Settings] in the LV super control panel and press the **OK** button.
  - [Card Slot Settings] options will be displayed.

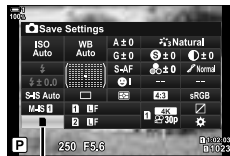

📷 save settings

- 2 Highlight [📷 Save Slot] using  $\Delta$   $\nabla$  on the arrow pad and press the  $\blacktriangleright$  button.



- 3 Highlight an option using the rear dial or the  $\Delta$   $\nabla$  buttons.

[1]: Photos are recorded to the card in Slot 1.



[2]: Photos are recorded to the card in Slot 2.



- 4 Press the **OK** button to select the highlighted option.

- 5 Press the **MENU** button repeatedly to exit the menus.

## ■ Menu Access

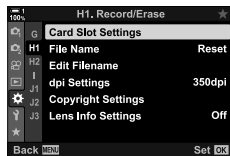

Choose a setting using [Card Slot Settings] (P. 547) > [📷 Save Slot] in  Custom Menu .

- [📷 Save Settings] (P. 72) is available when [Standard] or [Auto Switch] is selected.



**MENU** button  $\Rightarrow$   tab  $\Rightarrow$   tab  $\Rightarrow$  [Card Slot Settings]  $\Rightarrow$  [📷 Save Slot]  $\Rightarrow$  Press  $\blacktriangleright$  on the arrow pad to display options  $\Rightarrow$  Use the  $\Delta$   $\nabla$  buttons to choose an option

## Storage Slot Selection

If two memory cards are inserted with  (standard) or  (auto switch) selected for [ Save Settings], the card used to store pictures can be selected using the **CARD** (card select) button.

- 1 Press the **CARD** button.
  - You will be prompted to choose a slot.

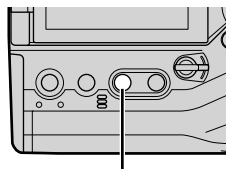

CARD button

- 2 Rotate the front or rear dial to choose the desired slot.

[1]: Record pictures to the card in Slot 1.

[2]: Record pictures to the card in Slot 2.



- 3 Press the **OK** button to exit.
  - The icon for the selected card will be displayed.



 save settings

# Storage Folder Selection (Assign Save Folder)

Choose the folder in which subsequent pictures will be stored.

- This setting can be accessed via:
  - The LV super control panel
  - The menus (P. 77)

<b>New Folder</b>	Create a new folder as the destination for subsequent pictures.
<b>Existing Folder</b>	Choose an existing folder.

- A new folder cannot be created if a folder with the same name exists on either memory card.

## ■ Access via the LV Super Control Panel

- 1 Highlight [📷 Save Settings] in the LV super control panel and press the **OK** button.
  - [Card Slot Settings] options will be displayed.

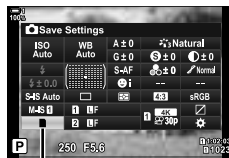

📷 save settings

- 2 Highlight [Assign Save Folder] using  $\Delta$ / $\nabla$  on the arrow pad and press the  $\triangleright$  button.



- 3 Highlight [Assign] using the  $\Delta$ / $\nabla$  buttons and press the **OK** button.





- 4 Highlight an option using the  $\Delta$   $\nabla$  buttons.  
 [New Folder]: Choose the desired folder number and press the **OK** button.  
 [Existing Folder]: Highlight an existing folder using the  $\Delta$   $\nabla$  buttons and press the **OK** button. The camera will display the first two photos and the last photo in the selected folder.
- 5 Press the **OK** button to select the highlighted option.
- 6 Press the **MENU** button repeatedly to exit the menus.



## ■ Menu Access

Choose a setting using [Card Slot Settings] (P. 547) > [Assign Save Folder] in **Custom Menu** **H1**.



2

**MENU** button  $\Rightarrow$  **Custom Menu** tab  $\Rightarrow$  **H1** tab  $\Rightarrow$  [Card Slot Settings]  $\Rightarrow$  [Assign Save Folder]  $\Rightarrow$  Press  $\triangleright$  on the arrow pad to display options  $\Rightarrow$  Use the  $\Delta$   $\nabla$  buttons to choose an option

## 2-4 Image Quality and Size

Choose the compression ratio, file format, and size used when saving pictures. The options available via the LV super control panel or live controls can be selected in the menus.

2

### Photo File and Image Size Options



Choose image quality settings used when photos are saved. When choosing an option, consider how the photos will be used: for example, are you planning to process it on a computer, or is it intended for upload to a website?

- This setting can be accessed via:
  - The LV super control panel
  - The menus (P. 79)
  - Live controls (P. 80)

#### ■ Access via the LV Super Control Panel

**1** In the LV super control panel, highlight the [📷⏏] option for Slot 1 (1) or Slot 2 (2).

- Choose the option used for each card when [Dual Independent ↓] or [Dual Independent ↑] is selected for [📷 Save Settings] (P. 72).



📷 image quality

## 2 Rotate the front dial to choose an option.

- Choose from the following options. The image size/compression combinations available can be selected in the menus. Custom Menu **G** > Set] (P. 81)

Option	Image size	Compression ratio	File format
SF	5184 × 3888	SuperFine (1/2.7)	JPG
F	5184 × 3888	Fine (1/4)	JPG
N	5184 × 3888	Normal (1/8)	JPG
M	3200 × 2400	Normal (1/8)	JPG
<b>RAW</b>	5184 × 3888	Lossless compression	ORF
<b>RAW+JPEG</b>	RAW plus the JPEG option selected above		

- When [Standard], [Dual Same ↓], or [Dual Same ↑], or [Auto Switch] is selected for [Card Slot Settings] > Save Settings] (P. 547) in Custom Menu **H**, the selected option applies to the cards in both slots ① and ②.
- 50F, 25F, 50F+RAW, and 25F+RAW options are available when High Res Shot (P. 210) is enabled.
- Selecting High Res Shot changes the image quality option selected; be sure to check the image quality setting before shooting.

## 3 Press the shutter button halfway to exit the LV super control panel.

- The image quality option selected may change if you change the option chosen for Save Settings] or remove a memory card and replace it with one that has space available. In particular, image quality will require readjustment when [Dual Independent ↓] or [Dual Independent ↑] is selected.

### ■ Menu Access

Select in Shooting Menu 1.



**MENU** button → tab → → Press on the arrow pad to display options → Use the buttons to choose an option



## Choosing Available Options

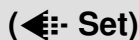

Choose the combinations of image size (measured in pixels) and compression (“image quality”) available in the [ Set] menu (P. 78).

1 Press the **MENU** button to display the menus.

2 Select Custom Menu **G** (WB/Color).

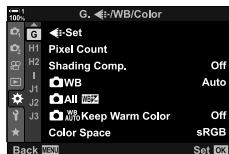

3 Highlight [ Set] using  $\Delta$   $\nabla$  on the arrow pad and press the  $\triangleright$  button.

- Image size and compression ratio selection options will be displayed.

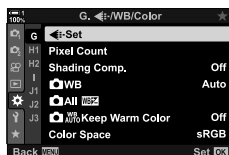

4 Using the  $\triangleleft$   $\triangleright$  buttons, highlight the size (in pixels) or compression ratio for the desired image quality setting ([-1]–[-4]) and then use the  $\Delta$   $\nabla$  buttons to choose a value.

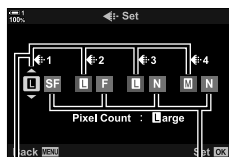

Image size (in pixels)

Compression ratio

- The following sizes and compression ratios are available. The sizes for [**M**] and [**S**] images can be selected from a menu.

Image size (pixels)		Compression ratio	
<b>L</b> (Large)	5184 x 3888	SF (Super Fine)	1/2.7
<b>M</b> (Medium)	3200 x 2400	F (Fine)	1/4
<b>S</b> (Small)	1280 x 960	N (Normal)	1/8

5 Press the **OK** button to accept the new values.

- Custom Menu **G** will be displayed.

6 Press the **MENU** button repeatedly to exit the menus.

2

## Choosing Values for [M] and [S] Sizes (Pixel Count)

Choose the size, in pixels, of the [M] (Middle) and [S] (Small) [📷] options (P. 78).

- The size, in pixels, of the [M] and [S] options can be selected from following:

<b>M</b> iddle (medium)	3200×2400, 1920×1440
<b>S</b> mall (small)	1280×960, 1024×768

1 Press the **MENU** button to display the menus.

2 Select **Custom Menu G** (📷/WB/Color).



3 Highlight [Pixel Count] using  $\Delta$   $\nabla$  on the arrow pad and press the  $\triangleright$  button.



4 Highlight [Middle] or [Small] using the  $\Delta$   $\nabla$  buttons and press the  $\triangleright$  button.

- Options will be displayed.

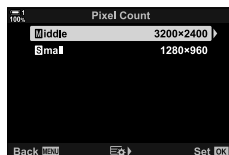

5 Choose a size using the  $\triangleleft$   $\triangleright$  buttons and press the **OK** button.

- The size-selection dialog ([Middle] or [Small]) will be displayed.

6 Press the **OK** button to accept the new values.

- Custom Menu G** will be displayed.

7 Press the **MENU** button repeatedly to exit the menus.

# 2-5 The Viewfinder and Monitor Displays

## Display Selection

The camera uses an eye sensor to automatically switch between the monitor and viewfinder displays. The monitor live view display and viewfinder also show information on camera settings. Options are available for controlling display switching and choosing the information shown.

### Framing photos in the monitor



Monitor



Put your eye to the viewfinder



### Framing photos in the viewfinder



Viewfinder



Live view in monitor shooting display



Putting your eye to the viewfinder turns the viewfinder on. The monitor turns off while the viewfinder is on.

- Pressing the  (LV) button switches the display in the monitor from live view to the super control panel. Putting your eye to viewfinder turns the viewfinder on. The monitor turns off.

 (LV) button

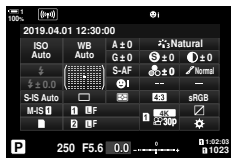
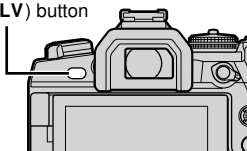

Monitor  
(super control panel)



- Display switching and viewfinder display options are available in the menu.  [EVF Auto Switch] (P. 553), [EVF Style] (P. 554)

## Choosing the Information Displayed

Press the **INFO** button.

- The information displayed changes each time the **INFO** button is pressed.

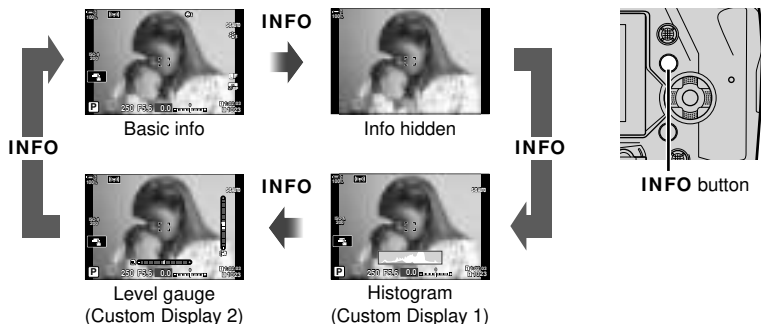

- You can also hold the **INFO** button and rotate the front or rear dial to choose the information displayed. The displays can be cycled in either direction.



- You can choose the items displayed in Custom Displays 1 and 2. You can also display data from GPS and other sensors. Use **Custom Menu** **D1** > **[Info Settings]** (P. 515) > **[LV-Info]** to choose items for display in live view, **Custom Menu** **1** > **[Info Settings]** (P. 555) to choose items for display in the viewfinder.

### ■ Histograms

Histograms graph the distribution of brightness in an image. The horizontal axis shows brightness, the vertical axis shows the number of pixels. During shooting, pixels brighter than the upper limit are shown in red, pixels darker than the lower limit in blue, and pixels in the spot metering area in green.

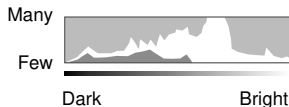

You can choose the upper and lower limits. **[Histogram Settings]** (P. 526)

### ■ Highlights and Shadows

Highlights and shadows, defined according to the upper and lower limits for the histogram display, are shown in red and blue. You can choose the upper and lower limits. **[Histogram Settings]** (P. 526)

### ■ The Level Gauge

The level gauge shows camera tilt. Pitch is shown by the vertical bar, roll by the horizontal bar.

- The level gauge is intended as a guide only.
- Calibrate the gauge if you find it is no longer truly plumb or level. **[Level Adjust]** (P. 559)



Adjust settings for switching between the monitor and viewfinder displays.

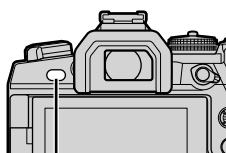

## ■ Using the (LV) Button

- 1 Press and hold the  button.
  - The [EVF Auto Switch] menu will be displayed.



 button



- 2 Highlight an option using   on the arrow pad and press the **OK** button.
 









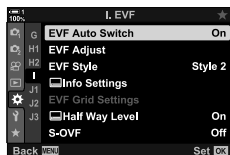

[On]: The display switches to the viewfinder when you put your eye to the viewfinder and to the monitor when you take your eye away. During live view, you can turn live view on or off by pressing the .

[Off]: Press the  button to switch back and forth between the monitor and viewfinder.

## ■ Menu Access

Adjust settings using [EVF Auto Switch] in  Custom Menu  (P. 553).



**MENU** button   tab   tab  [EVF Auto Switch]  Press  on the arrow pad to display options  Use the   buttons to choose an option

# The Shooting Display

Camera menus can be used to choose the information shown in the monitor and viewfinder. [Info Settings] (P. 515), [Info Settings] (P. 555)

## Monitor (Still Photography)

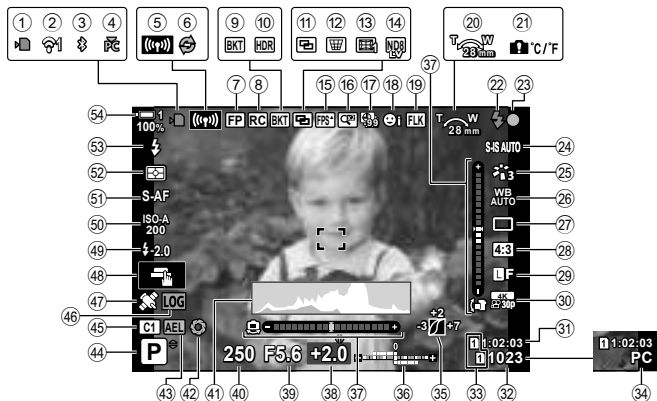

- |  |  |
|--|--|
| ① Memory card access indicator ..... P. 37           | ①7 Interval timer photography ..... P. 172   |
| ② Wireless LAN connection status ..... P. 584, 600   | ①8 Face/eye priority ..... P. 133  |
| ③ Active <b>Bluetooth</b> ® connection ..... P. 586  | ①9 Flickerless photography ..... P. 190  |
| ④ Active connection to computer (Wi-Fi) ..... P. 600 | ②0 Zoom direction/focal length   |
| ⑤ Wireless LAN connection ..... P. 592, 596, 597     | ②1 Internal temperature warning ..... P. 639   |
| ⑥ Pro Capture active ..... P. 168                    | ②2 Flash-ready indicator ..... P. 252<br>(blinking: charging in progress;<br>steady: charging complete)  |
| ⑦ Super FP flash ..... P. 252                        | ②3 In-focus indicator ..... P. 53  |
| ⑧ RC mode ..... P. 252                               | ②4  image stabilization ..... P. 176   |
| ⑨ Bracketing ..... P. 236                            | ②5 Picture mode ..... P. 215   |
| ⑩ HDR ..... P. 195                                   | ②6  white balance ..... P. 202   |
| ⑪ Multiple exposure ..... P. 246                     | ②7 Drive mode (single-frame/sequential shooting/self-timer/vibration reduction/silent photography/Pro Capture/High Res Shot) ..... P. 151–170, 210 |
| ⑫ Keystone compensation ..... P. 248                 | ②8 Aspect ratio ..... P. 233   |
| ⑬ Fisheye correction ..... P. 250                    | ②9  image quality ..... P. 78  |
| ⑭ Live ND filter photography ..... P. 197            | ③0  image quality* ..... P. 321  |
| ⑮ High frame rate ..... P. 175                       |  |
| ⑯ Digital teleconverter ..... P. 235                 |  |

\* Settings indicated by a "🎬" (movie) icon are for movie recording. See "3 Shooting and Viewing Movies" (P. 293).

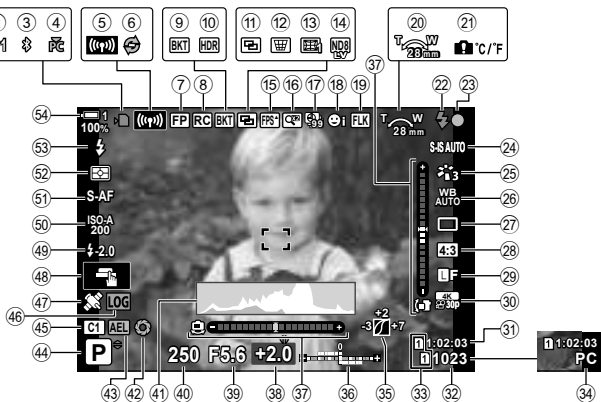

- 31 Available recording time ..... P. 655
- 32 Number of exposures remaining..... P. 654
- 33 Card slot settings  
 Top: save slot ..... P. 316  
 Bottom: save settings ..... P. 72
- 34 Active connection to computer (USB)\*  
 ..... P. 600
- 35 Highlight & shadow control ..... P. 227
- 36 Top: flash compensation ..... P. 259  
 Bottom: exposure compensation .... P. 180
- 37 Level gauge ..... P. 84
- 38 Exposure compensation value..... P. 180
- 39 Aperture value .....P. 94–102
- 40 Shutter speed .....P. 94–102
- 41 Histogram ..... P. 84
- 42 Preview ..... P. 464
- 43 Exposure lock ..... P. 188
- 44 Shooting mode.....P. 93–110
- 45 Custom mode ..... P. 111
- 46 Log status ..... P. 571
- 47 GPS status..... P. 570
- 48 Touch controls..... P. 54
- 49 Flash compensation..... P. 259
- 50 ISO sensitivity..... P. 181
- 51 AF mode ..... P. 115
- 52 Metering mode..... P. 186
- 53 Flash mode..... P. 254
- 54 Battery level/bay number ..... P. 44

\* Displayed only if a computer is currently selected in the [] menu as the sole destination for new pictures (P. 622).

• You can also display data from GPS and other sensors. “5-2 Using Field Sensors” (P. 570)

## Viewfinder (Still Photography)

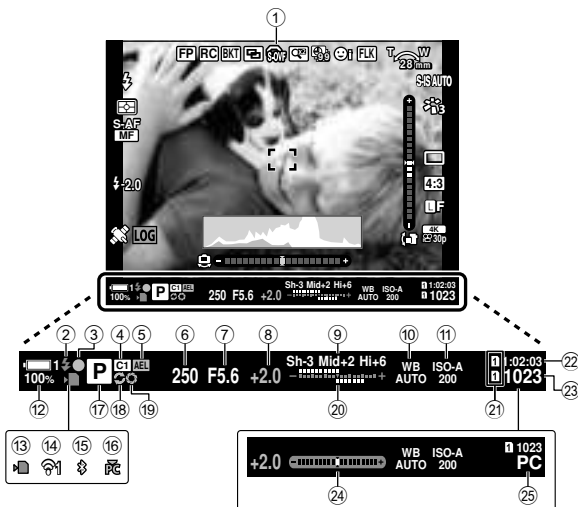

- This is the default display style ([Style 2]). The display style can be selected using Custom Menu **1** > [EVF Style] (P. 554). To display the same information as appears in the monitor, choose [Style 3] for [EVF Style].

- |   |  |
|---|--|
| ①  OVF simulation*1 ..... P. 89   | ⑮ Active <b>Bluetooth</b> ® connection ..... P. 586  |
| ② Flash-ready indicator ..... P. 252<br>(Blinks: flash charging; on: charging complete) | ⑯ Active connection to computer (Wi-Fi) ..... P. 600 |
| ③ In-focus indicator ..... P. 53  | ⑰ Shooting mode..... P. 93–110                       |
| ④ Custom mode ..... P. 111  | ⑱ Pro Capture active ..... P. 168                    |
| ⑤ Exposure lock ..... P. 188  | ⑲ Preview ..... P. 464                               |
| ⑥ Shutter speed .....P. 94–102  | ⑳ Top: flash compensation..... P. 259                |
| ⑦ Aperture value .....P. 94–102   | Bottom: exposure compensation .... P. 180            |
| ⑧ Exposure compensation value..... P. 180   | ㉑ Card slot settings                                 |
| ⑨ Highlight & shadow control ..... P. 227   | Top:  save slot ..... P. 316                         |
| ⑩  white balance ..... P. 202   | Bottom:  save settings ..... P. 72                   |
| ⑪  ISO sensitivity..... P. 181  | ㉒ Available recording time ..... P. 655              |
| ⑫ Battery level/bay number..... P. 44   | ㉓ Number of exposures remaining..... P. 654          |
| ⑬ Memory card access indicator..... P. 37   | ㉔ Level gauge*2 ..... P. 556                         |
| ⑭ Wireless LAN connection..... P. 584, 600  | ㉕ Active connection to computer (USB)*3 ..... P. 600 |

\*1 Displayed in the viewfinder only. [S-OVF] (P. 89)

\*2 Displayed when the shutter button is pressed halfway. [Half Way Level] (P. 556)

\*3 Displayed only if a computer is currently selected in the () menu as the sole destination for new pictures (P. 622).

Increase dynamic range of the viewfinder display, increasing the amount of detail visible in highlights and shadows in a manner similar to optical viewfinders. Backlit subjects and the like are easier to see.

- The effects of exposure, white balance, picture mode art filters, and other shooting settings cannot be previewed while optical viewfinder simulation is in effect.

**1** Press the **MENU** button to display the menus.

**2** Select **Custom Menu 1** (EVF).

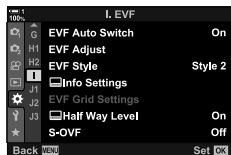

**3** Highlight [S-OVF] using  $\Delta$   $\nabla$  on the arrow pad and press the  $\blacktriangleright$  button.

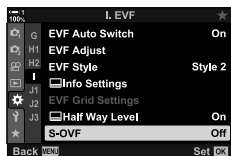

2

**4** Highlight an option using the  $\Delta$   $\nabla$  buttons.

[Off]: The effects of exposure and other settings are visible in the viewfinder display. Choose this option to preview the effects of settings during shooting.

[On]: Dynamic range is increased. The effects of exposure, white balance, and other shooting settings are not visible in the display.

**5** Press the **OK** button to select the highlighted option.

- **Custom Menu 1** will be displayed.

**6** Press the **MENU** button repeatedly to exit the menus.





- This option can be assigned to a camera control using [Camera Button Function] in **Custom Menu 1**. You can then turn optical viewfinder simulation on or off at the touch of a button. **Custom Menu 1** [Camera Button Function] (P. 463)

## 2-6 Photo Review (Rec View)



Pictures are displayed immediately after shooting. This gives you a chance to quickly review the shot. You can choose how long pictures are displayed or disable photo review altogether.

To end photo review and resume shooting at any time, press the shutter button halfway. This item defaults to [Off].

<b>0.3–20sec</b>	Choose how long photos are displayed.
<b>Off</b>	Photo review disabled. The camera continues to display the view through the lens after shooting.
<b>Auto</b> 	Switch to playback after shooting. You can delete images and perform other playback operations.

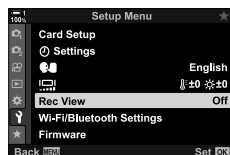
- 1 Press the **MENU** button to display the menus.
- 2 Highlight [Rec View] in the  setup menu and press  on the arrow pad.



- 3 Highlight an option using the   buttons.



- 4 Press the **OK** button to select the highlighted option.
  - The  setup menu will be displayed.
- 5 Press the **MENU** button repeatedly to exit the menus.

## 2-7 Restoring Default Settings (Reset)

Reset the camera to factory default settings. You can opt to reset almost all settings or only those directly related to photography.

<b>Full</b>	Reset all settings with a few exceptions, such as the clock and language.
<b>Basic</b>	Reset photography-related settings only.

- See “7-4 Default Settings” (P. 640) for information on the settings that are reset.

- 1 Press the **MENU** button to display the menus.
- 2 Highlight [Reset / Custom Modes] in Shooting Menu 1 and press on the arrow pad.



2

- 3 Highlight [Reset] using the buttons and press the button.

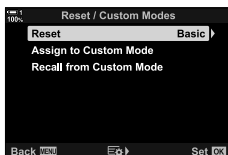

- 4 Highlight an option using the buttons.



- 5 Press the **OK** button to select the highlighted option.
  - The [Reset / Custom Modes] menu will be displayed.
- 6 Press the **OK** button in the [Reset / Custom Modes] menu.
  - The [Reset] menu will be displayed.
- 7 Highlight [Yes] using the buttons and press the **OK** button.
  - Settings will be reset.



- Settings can be saved to a computer using Olympus Workspace. For more information, visit the OLYMPUS website at the following URL:  
<https://support.olympus-imaging.com/owdownload/>



## 2-8 Choosing a Shooting Mode

Choose a shooting mode according to your artistic intent. The shooting mode is selected with the mode dial. Choose custom modes to save and recall shooting settings as required.

### ■ Shooting Modes

See the page numbers listed below for more information.

<b>P</b>	Program AE (P. 94)
<b>A</b>	Aperture-priority AE (P. 96)
<b>S</b>	Shutter-priority AE (P. 98)
<b>M</b>	Manual exposure (P. 101)
<b>B</b>	Bulb/time (P. 104)
	Live composite (P. 108)
	Movie (P. 294)
<b>C1–C4</b>	Custom (P. 111)

Selected mode

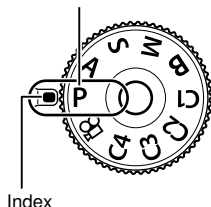

### ■ Choosing a Shooting Mode

- 1 Press the mode dial lock to unlock the mode dial.
  - The mode dial locks while the mode dial lock is depressed. Press the lock to lock or unlock the dial.

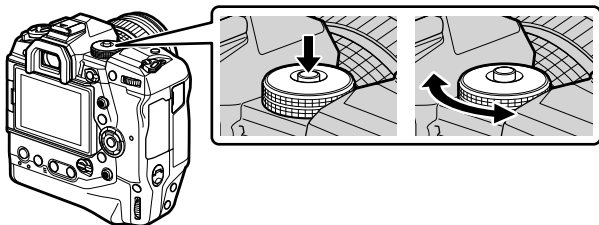

- 2 Rotate the mode dial to choose a mode.
- 3 Press the mode dial lock to lock the dial.

# Letting the Camera Choose Aperture and Shutter Speed (P: Program AE)

The camera chooses the optimal aperture and shutter speed according to subject brightness.

1 Rotate the mode dial to **P**.

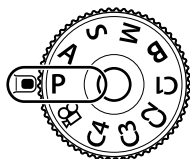

2 Focus and check the display.

- The shutter speed and aperture chosen by the camera are displayed.

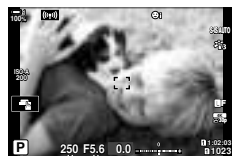

Shooting mode  
Shutter speed  
Aperture

3 Take pictures.

## Subject Too Dark or Too Bright

If the camera is unable to achieve optimal exposure, the shutter-speed and aperture displays will flash as shown.

Display	Problem/solution
<p>Large aperture (low f/-number)/ slow shutter speed</p>	<p>The subject is too dark.</p> <ul style="list-style-type: none"> <li>Use a flash.</li> </ul>
<p>Small aperture (high f/-number)/ fast shutter speed</p>	<p>Subject is too bright.</p> <ul style="list-style-type: none"> <li>The limits of the camera metering system have been exceeded. Use a third-party ND (Neutral Density) filter to reduce the amount of light entering the camera.</li> <li>Shutter speeds as fast as 1/32000 s are available in [♥] (silent) mode. [📷] "2-10 Drive Mode ([📷]/[📷]/[📷])" (P. 151)</li> </ul>



- If auto ISO sensitivity control is disabled, choose a value using [📷 ISO]. [📷] "Adjusting ISO Sensitivity ([📷 ISO])" (P. 181)
- The aperture value shown when the displays flash varies with the lens and focal length.

## Adjusting Settings in Mode P







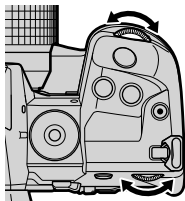

Use the front and rear dials to adjust the following settings.

Front dial: Exposure compensation (P. 180)

Rear dial: Program shift

- Exposure compensation can also be adjusted using the  button. Press the  button and rotate the front or rear dial.



- You can choose the functions performed by the front and rear dials.   Custom Menu  [  Dial Function ] (P. 473)
- You can use the **Fn** lever to reverse the roles of the front and rear dials. The lever can also be assigned other roles.   Custom Menu  [  Fn Lever Function ] (P. 475)

## Program Shift

Without changing exposure, you can choose from different combinations of aperture and shutter speed selected automatically by the camera. This is known as program shift.

- Rotate the rear dial until the camera displays the desired combination of aperture and shutter speed.
- The shooting mode indicator in the display changes from **P** to **Ps** while program shift is in effect. To end program shift, rotate the rear dial in the opposite direction until **Ps** is no longer displayed.



Program shift



- You can choose whether the display reflects the effects of exposure compensation or maintains a constant brightness for ease of viewing. At default settings, the effects of exposure settings are visible in the display.  [Live View Boost] (P. 200)

## Choosing an Aperture

## (A: Aperture-Priority AE)

In this mode, you choose the aperture (f/-number) and the camera automatically sets the shutter speed for optimal exposure according to subject brightness. Lower aperture values (larger apertures) reduce the depth of the area that appears to be in focus (depth of field), blurring the background. Higher aperture values (smaller apertures) increase the depth of the area that appears to be in focus in front of and behind the subject.

Lower aperture values...



...reduce depth of field and increase blur.

Higher aperture values...

...increase depth of field.

- 1 Rotate the mode dial to **A**.

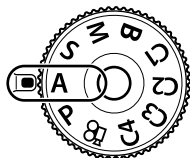

2

- 2 Choose an aperture.

- At default settings, aperture is selected by rotating the rear dial.
- The shutter speed selected automatically by the camera will appear in the display.



Aperture value

- 3 Take pictures.

## Subject Too Dark or Too Bright

If the camera is unable to achieve optimal exposure, the shutter-speed display will flash as shown.

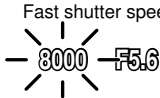
Display	Problem/solution
<p>Slow shutter speed</p> 	<p>Underexposure.</p> <ul style="list-style-type: none"><li>Choose a lower aperture value.</li></ul>
<p>Fast shutter speed</p> 	<p>Overexposure.</p> <ul style="list-style-type: none"><li>Choose a higher aperture value.</li><li>If the subject is still overexposed at the higher value, the limits of the camera metering system have been exceeded. Use a third-party ND (Neutral Density) filter to reduce the amount of light entering the camera.</li><li>Shutter speeds as fast as 1/32000 s are available in [♥] (silent) mode. [ⓘ] "2-10 Drive Mode ([⏏]/[⏏]/[⏏])" (P. 151)</li></ul>

- If auto ISO sensitivity control is disabled, choose a value using [📷 ISO]. [ⓘ] "Adjusting ISO Sensitivity ([📷 ISO])" (P. 181)

## Adjusting Settings in Mode A

Use the front and rear dials to adjust the following settings.

Front dial: Exposure compensation (P. 180)

Rear dial: Aperture

- Exposure compensation can also be adjusted using the [⏏] button. Press the [⏏] button and rotate the front or rear dial.

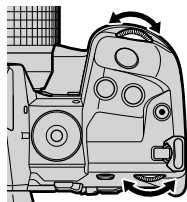

- You can choose the functions performed by the front and rear dials. [ⓘ] ⚙ Custom Menu **B1** [📷 Dial Function] (P. 473)
- You can use the **Fn** lever to reverse the roles of the front and rear dials. The lever can also be assigned other roles. [ⓘ] ⚙ Custom Menu **B1** [📷 Fn Lever Function] (P. 475)
- You can choose whether the display reflects the effects of exposure settings or maintains a constant brightness for ease of viewing. At default settings, the effects of exposure settings are visible in the display. [ⓘ] [Live View Boost] (P. 200)
- You can stop aperture down to the selected value and preview its effects. [ⓘ] ⚙ Custom Menu **B1** [📷 Button Function] (P. 464)

## Choosing a Shutter Speed (S: Shutter-Priority AE)

In this mode, you choose the shutter speed and the camera automatically sets aperture for optimal exposure according to subject brightness. Faster shutter speeds appear to “freeze” fast-moving subjects. Slower shutter speeds add blur to moving objects, lending them a sense of motion for a dynamic effect.

**Slower shutter speeds...**



60" ← 15 ← 30 ← 60 → 125 → 250 → 8000  
...produce dynamic shots with a sense of motion.

**Faster shutter speeds...**

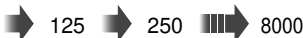

...“freeze” the motion of fast-moving subjects.

- 1 Rotate the mode dial to **S**.

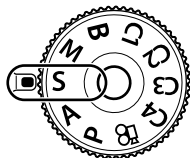

2

- 2 Choose a shutter speed.

- At default settings, shutter speed is selected by rotating the rear dial.
- Shutter speed can be set to values between 1/8000 and 60 s.
- Shutter speeds as fast as 1/32000 s are available in [♥] (silent) mode. [Silent [♥]] (P. 163)
- The aperture selected automatically by the camera will appear in the display.

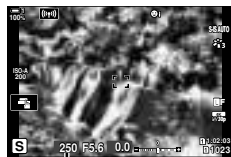





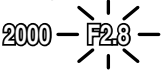
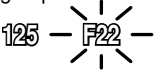

Shutter speed

- 3 Take pictures.

## Subject Too Dark or Too Bright

If the camera is unable to achieve optimal exposure, the aperture display will flash as shown.

Display	Problem/solution
Low aperture value 	Underexposure. <ul style="list-style-type: none"><li>Choose a slower shutter speed.</li></ul>
High aperture value 	Overexposure. <ul style="list-style-type: none"><li>Choose a faster shutter speed.</li><li>If the subject is still overexposed at the higher speed, the limits of the camera metering system have been exceeded. Use a third-party ND (Neutral Density) filter to reduce the amount of light entering the camera.</li><li>Shutter speeds as fast as 1/32000 s are available in [♥] (silent) mode.  "2-10 Drive Mode (/🔄/📷)" (P. 151)</li></ul>



- If auto ISO sensitivity control is disabled, choose a value using [ ISO].  "Adjusting ISO Sensitivity ( ISO)" (P. 181)
- The aperture value shown when the display flashes varies with the lens and focal length.

## Adjusting Settings in Mode S









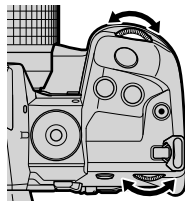



Use the front and rear dials to adjust the following settings.

Front dial: Exposure compensation (P. 180)

Rear dial: Shutter speed

- Exposure compensation can also be adjusted using the  button. Press the  button and rotate the front or rear dial.



- You can choose the functions performed by the front and rear dials.   Custom Menu  [  Dial Function ] (P. 473)
- You can use the **Fn** lever to reverse the roles of the front and rear dials. The lever can also be assigned other roles.   Custom Menu  [  Fn Lever Function ] (P. 475)
- You can choose whether the display reflects the effects of exposure settings or maintains a constant brightness for ease of viewing. At default settings, the effects of exposure settings are visible in the display.  [Live View Boost] (P. 200)
- To achieve the effect of a slow shutter in brightly-lit settings in which slow shutter speeds are not otherwise available, use the live ND filter.  [Live ND Shooting] (P. 197)
- Depending on the shutter speed selected, you may notice banding in the display caused by flicker from fluorescent or LED light sources. The camera can be configured to reduce the effects of flicker during live view or when pictures are taken.  [Flicker reduction] (P. 190), [  Flicker Scan ] (P. 193)



# Choosing Aperture and Shutter Speed (M: Manual Exposure)

In this mode, you choose the aperture and shutter speed. You can adjust settings according to your goals, for example by combining fast shutter speeds with small apertures (high f-numbers) for increased depth of field.

**1** Rotate the mode dial to **M**.

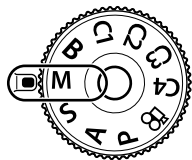

**2** Adjust aperture and shutter speed.

- At default settings, aperture is selected with the front dial and shutter speed with the rear dial.
- Choose from shutter speeds of 1/8000–60 s.
- Shutter speeds as fast as 1/32000 s are available in [♥] (silent) mode. “2-10 Drive Mode (/ / )” (P. 151)
- The display shows the difference between the exposure produced by the selected aperture and shutter speed and the optimal exposure metered by the camera. The display will flash if the difference exceeds  $\pm 3$  EV.
- When [AUTO] is selected for [📷 ISO], ISO sensitivity will automatically be adjusted for optimal exposure at the selected exposure settings. [📷 ISO] defaults to [AUTO]. “Adjusting ISO Sensitivity (📷 ISO)” (P. 181)





Difference from optimal exposure

2



**3** Take pictures.

## Subject Too Dark or Too Bright

If the camera is unable to achieve optimal exposure with [AUTO] selected for [📷 ISO], the ISO sensitivity display will flash as shown.

Display	Problem/solution
	Overexposure. <ul style="list-style-type: none"><li>• Choose a higher aperture value or faster shutter speed.</li></ul>
	Underexposure. <ul style="list-style-type: none"><li>• Choose a lower aperture value or slower shutter speed.</li><li>• If the warning does not clear from the display, choose a higher value for [📷 ISO-Auto Set] &gt; [High Limit].</li></ul>



- Depending on the shutter speed selected, you may notice banding in the display caused by flicker from fluorescent or LED light sources. The camera can be configured to reduce the effects of flicker during live view or when pictures are taken.  [Flicker reduction] (P. 190),  [Flicker Scan] (P. 193)
- You can choose whether the display reflects the effects of exposure settings or maintains a constant brightness for ease of viewing. At default settings, the display maintains a constant brightness for ease of viewing.  [Live View Boost] (P. 200)





## Adjusting Settings in Mode M

Use the front and rear dials to adjust the following settings.

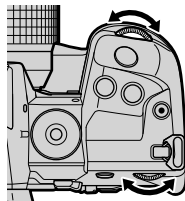
Front dial: Aperture



Rear dial: Shutter speed



- You can choose the functions performed by the front and rear dials.   Custom Menu **B1** [📷 Dial Function] (P. 473)
- You can use the **Fn** lever to reverse the roles of the front and rear dials. The lever can also be assigned other roles.   Custom Menu **B1** [📷 Fn Lever Function] (P. 475)

## Using Exposure Compensation in Mode M

In mode **M**, exposure compensation is available when [AUTO] is selected for [ISO]. Because exposure compensation is performed by adjusting ISO sensitivity, aperture and shutter speed are not affected. [ISO] [ISO] (P. 181), [ISO-Auto Set] (P. 183)

- Exposure compensation can be adjusted using the  button. Hold the  button and rotate the front or rear dial.
- Exposure compensation is added to the exposure difference shown in the display.



Exposure  
compensation

Exposure compensation  
plus exposure difference

2

Select this mode to leave the shutter open for a long exposure. You can preview the photo in live view and end the exposure when the desired results have been achieved. Use when long exposures are required, for example when photographing night scenes or fireworks.

## “Bulb” and “Live Bulb” Photography

The shutter remains open while the shutter button is pressed. Releasing the button ends the exposure.

- The amount of light entering the camera increases the longer the shutter is open.
- When live bulb photography is selected, you can choose how often the camera updates the live view display during the exposure.

## “Time” and “Live Time” Photography

The exposure begins when the shutter button is pressed all the way down. To end the exposure, press the shutter button all the way down a second time.

- The amount of light entering the camera increases the longer the shutter is open.
- When live time photography is selected, you can choose how often the camera updates the live view display during the exposure.

2

- 1 Rotate the mode dial to **B**.

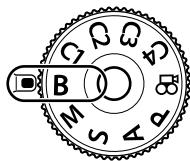

- 2 Select bulb or time photography.

- At default settings, the selection is made with the rear dial.



Bulb or time photography

- 3 Press the **MENU** button.

- You will be prompted to choose the interval at which the preview is updated.

**4** Highlight an interval using  $\Delta$   $\nabla$  on the arrow pad.

- Select [Off] to disable the preview.

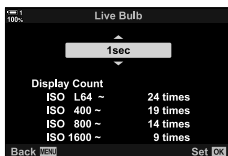

**5** Press the **OK** button to select the highlighted option.

- The menus will be displayed.

**6** Press the shutter button halfway to exit the menus.

- If an option other than [Off] is selected, [LIVE BULB] or [LIVE TIME] will appear in the display.

**7** Adjust aperture.

- At default settings, aperture can be adjusted using the front dial.



Aperture



2

**8** Take pictures.

- In bulb and live bulb modes, keep the shutter button pressed. The exposure ends when the button is released.
- In time and live time modes, press the shutter button all the way down once to start the exposure and again to end it.
- The exposure ends automatically when the time selected for [Bulb/Time Timer] is reached. The default is [8 min]. The time can be changed.  [Bulb/Time Timer] (P. 533)
- [Noise Reduct.] is applied after shooting. The display shows the time remaining until the process is complete. You can choose the conditions under which noise reduction is performed (P. 533).

- During live time photography, you can refresh the preview by pressing the shutter button halfway.
- Some limitations apply to the choice of ISO sensitivity settings available.
- Bulb photography is used in place of live bulb photography when multiple exposure, keystone compensation, or fisheye correction is in effect.
- Time photography is used in place of live time photography when multiple exposure, keystone compensation, or fisheye correction is in effect.
- Limitations apply to some features during shooting, including:
  - sequential shooting, the self-timer, interval timer photography, AE and flash bracketing, and multiple exposure; limitations also apply during live bulb and live time photography.
-  [Image Stabilizer] (P. 176) turns off automatically.
- Depending on camera settings, the temperature, and the situation, you may notice noise or bright spots in the monitor. These may sometimes appear in pictures even when [Noise Reduct.] (P. 533) is enabled.



- Display brightness can be adjusted during bulb/time photography. At default settings, the display is darker than normal.  [Bulb/Time Monitor] (P. 534)
- During bulb/time photography, the brightness of the subject in the display is enhanced for ease of viewing when lighting is poor. Settings can be adjusted, for example to prioritize image quality or the display rate.  [Live View Boost] (P. 200)

### Noise

The longer the exposure, the greater the number of image artifacts (“noise”) that appears in the display. The increasing temperature of the image sensor and its internal circuitry turns them into heat sources that generate currents in areas of the sensor not otherwise exposed to light. This phenomenon becomes more noticeable if you increase ISO sensitivity or exposure times when shooting at high ambient temperatures. The camera’s long-exposure noise reduction helps reduce this type of noise.  [Noise Reduct.] (P. 533)

## Adjusting Focus During Exposures (Bulb/Time Focusing)

You can adjust focus manually while shooting in **B** (bulb) mode. This allows you to defocus during the exposure or focus at the end of the exposure.

- 1 Press the **MENU** button to display the menus.
- 2 Select  Custom Menu **A4** (AF/MF).

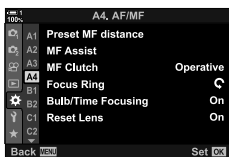

- 3 Highlight [Bulb/Time Focusing] using  $\Delta$   $\nabla$  on the arrow pad and press the  $\blacktriangleright$  button.



- 4 Highlight an option using the  $\Delta$   $\nabla$  buttons.  
[Off]: The focus position cannot be adjusted manually during an exposure.  
[On]: The focus position can be adjusted manually during an exposure.
- 5 Press the **OK** button to select the highlighted option.
  -  Custom Menu **A4** will be displayed.
- 6 Press the **MENU** button repeatedly to exit the menus.
  - You can also exit the menus by pressing the shutter button halfway.

2

## Lighten Blending (B: Live Composite Photography)

Leave the shutter open for a long exposure. You can view the light trails left by fireworks or stars and photograph them without changing the exposure of the background. The camera combines multiple shots and records them as a single photograph.

- 1 Rotate the mode dial to **B**.

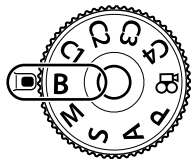

- 2 Select [LIVE COMP].

- At default settings, the selection is made with the rear dial.

- 3 Press the **MENU** button.

- The [Composite Settings] menu will be displayed.



Live composite photography

- 4 Highlight an exposure time using  $\Delta$   $\nabla$  on the arrow pad.

- Choose an exposure time of from 1/2 to 60 s.

- 5 Press the **OK** button to select the highlighted option.

- The menus will be displayed.



- 6 Press the **MENU** button repeatedly to exit the menus.

- You can also exit the menus by pressing the shutter button halfway.

- 7 Press the shutter button all the way down to ready the camera.

- The camera is ready to shoot when [Ready for composite shooting] is displayed.
- Adjust aperture using the front dial. The exposure bar shows the difference between the exposure produced by the selected settings and the optimal exposure metered by the camera.



- 8 Press the shutter button to start shooting.



- Live composite photography will start. The display will be updated after each exposure.



- 9** Press the shutter button again to end shooting.
- Live composite photography can continue for up to three hours. The maximum recording time available varies with battery level and shooting conditions.
  - Some limitations apply to the choice of ISO sensitivity settings available.
  - Limitations apply to some features during shooting, including:
    - sequential shooting, the self-timer, interval timer photography, HDR photography, AE bracketing, flash bracketing, focus bracketing, High Res Shot, multiple exposure, keystone compensation, the live ND filter, and fisheye correction.
  - [📷 Image Stabilizer] (P. 176) turns off automatically.
-  • Display brightness can be adjusted during live composite photography. At default settings, the display is darker than normal. [👉 Bulb/Time Monitor] (P. 534)

## Choosing the Shutter Speed (Composite Settings)

The exposure time for each exposure made during live composite photography can be chosen in advance using the menus.

- 1 Press the **MENU** button to display the menus.
- 2 Select  Custom Menu  (Exp/ISO/BULB/).



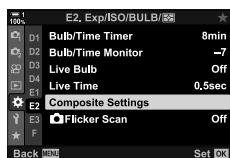

- 3 Highlight [Composite Settings] using  $\Delta$   $\nabla$  on the arrow pad and press the  $\blacktriangleright$  button.



- 4 Highlight an option using the  $\Delta$   $\nabla$  buttons.
  - Choose an exposure time of from 1/2 to 60 s.



- 5 Press the **OK** button to select the highlighted option.
  -  Custom Menu  will be displayed.
- 6 Press the **MENU** button repeatedly to exit the menus.

# Saving Custom Settings to the Mode Dial (C1/C2/C3/C4 Custom Modes)



Frequently-used settings and shooting modes can be saved as custom modes and recalled as needed simply by rotating the mode dial. Saved menu settings can also be recalled directly.



- Save settings to positions **C1** through **C4**.
- At default settings, custom modes are equivalent to mode **P**.



## Saving Settings (Assign to Custom Mode)

- 1 Rotate the mode dial to **P**, **A**, **S**, **M**, or **B** and adjust settings as desired.
  - For information on the settings that can be saved, see the menu list (P. 640).

- 2 Press the **MENU** button to display the menus.

- 3 Highlight [Reset / Custom Modes] in  Shooting Menu 1 and press  on the arrow pad.
  - [Reset / Custom Modes] options will be displayed.

- 4 Highlight [Assign to Custom Mode] using the   buttons and press the  button.
  - [Assign to Custom Mode] options will be displayed.

- 5 Highlight the desired custom mode (**C1**, **C2**, **C3**, or **C4**) using the   buttons and press the  button.
  - The menu for the selected custom mode will be displayed.

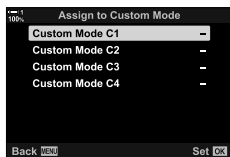
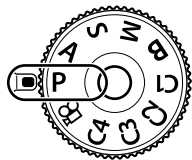

2

- 6** Highlight [Set] using the  $\Delta$   $\nabla$  buttons and press the **OK** button.
- The [Assign to Custom Mode] menu will be displayed again.
  - Any existing settings will be overwritten.
  - To restore default settings for the selected custom mode, highlight [Reset] and press the **OK** button.

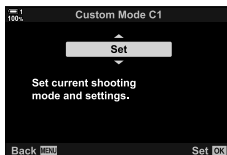

- 7** Press the **MENU** button repeatedly to exit the menus.

## Using Custom Modes (C1/C2/C3/C4)

To recall all saved settings, including the shooting mode:

- 1** Rotate the mode dial to the desired custom mode (**C1**, **C2**, **C3**, or **C4**).
- The camera will be set to the settings for the selected mode.

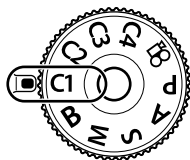

- Saved settings will not be affected if you adjust settings after recall. The saved settings will be restored when next you select the custom mode with the mode dial.

### ■ Recalling Saved Settings

In modes **P**, **A**, **S**, **M**, and **B**, you can recall saved settings but not the shooting mode. The shooting mode remains that currently selected with the mode dial.

- 1** Press the **MENU** button to display the menus.
- 2** Highlight [Reset / Custom Modes] in  $\square$  Shooting Menu 1 and press  $\triangleright$  on the arrow pad.
- [Reset / Custom Modes] options will be displayed.



- 3 Highlight [Recall from Custom Mode] using the  $\Delta$   $\nabla$  buttons and press the  $\triangleright$  button.

- The [Recall from Custom Mode] menu will be displayed.



- 4 Highlight the desired custom mode using the  $\Delta$   $\nabla$  buttons and press the  $\triangleright$  button.

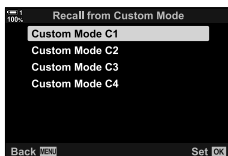

- 5 Highlight [Yes] using the  $\Delta$   $\nabla$  buttons and press the **OK** button.

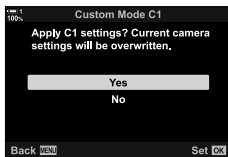

- Shooting Menu 1 will be displayed.



- 6 Press the **MENU** button repeatedly to exit the menus.

### ■ Using the Fn Button

[Recall from Custom Mode] can be assigned to a camera control. Settings for a selected custom mode can be recalled at the touch of a button. The selected shooting mode is also recalled. Press the control to turn the custom mode on or off.

  Custom Menu **B1**  Button Function] (P. 463)

## 2-9 Focus



Focus can be adjusted automatically (autofocus) or manually (manual focus).

Autofocus features options for focusing on selected points or to track focus on a moving subject. In the case of moving subjects in particular, by adjusting settings according to the type of subject or shooting conditions, you can photograph a greater variety of subjects. This section covers autofocus photography, including how you can combine settings to get the most from autofocus.

Choose the focus mode for auto or manual focus.

**Autofocus (AF):** The camera focuses automatically. Choose from single AF (P. 115), in which the camera focuses just once when the shutter button is pressed halfway, and continuous AF (P. 115), in which the camera adjusts focus continuously while the shutter button is pressed. Also available is tracking AF (P. 116), in which focus detects and tracks the subject.

**Manual focus (MF):** Focus manually by rotating the lens focus ring (P. 116). Also available is preset MF (P. 116), in which the camera focuses at a preset distance.

**AF+MF:** Focus can be adjusted manually using the lens focus ring. Switch from auto to manual focus at will or fine-tune focus manually after focusing with autofocus (P. 117). If [On] is selected for  AF+MF in  Custom Menu **A1**, **MF** will be displayed in [S-AF], [C-AF], and [C-AF+TR] modes. [On] is selected by default (P. 481).

- This setting can be accessed via:
  - The **AF**  button (P. 118)
  - The LV Super Control panel (P. 119)
  - Live controls (P. 119)
  - The menus (P. 119)
- The explanation that follows assumes that camera defaults are used for the beep that sounds and the AF target displayed when the camera focuses.

### Single AF (S-AF **MF** and S-AF)

Choose for photographs of subjects that are stationary or are not moving away from or toward the camera. The camera focuses once each time the shutter button is pressed halfway.

- When the camera focuses, a beep will sound. The in-focus indicator and AF target will be displayed.
- Autofocus with manual adjustment is available in [S-AF **MF**] mode. Keep the shutter button pressed halfway and adjust focus manually (P. 117).

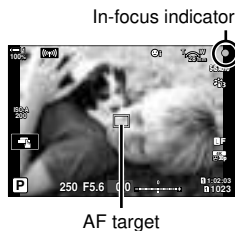



### Continuous AF (C-AF **MF** and C-AF)

Track focus on subjects whose distance to the camera is continuously changing. The camera focuses continuously while the shutter button is pressed halfway.

- The in-focus indicator is displayed when the subject is in focus. The beep sounds and the AF target is displayed only the first time the subject is in focus.
- Autofocus with manual adjustment is available when [C-AF **MF**] is selected. Rotate the lens focus ring to interrupt autofocus and focus manually (P. 117).

## Manual Focus (MF)

Focus manually.

- Rotate the lens focus ring to focus.
- If the lens is equipped with an MF clutch, you can rotate the lens focus ring to engage manual focus regardless of the focus mode selected with the camera.  “Lens MF Clutch (Manual Focus Clutch)” (P. 127)
- The MF clutch can be disabled.  [MF Clutch] (P. 128)

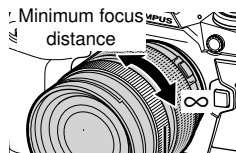

Focus ring

## Tracking AF (C-AF+TR<sup>MF</sup> and C-AF+TR)

Track focus on a specific subject while keeping the composition roughly the same. On detecting the subject, the camera will continue to track it while the shutter button is pressed halfway.

- The camera detects the subject when the shutter button is pressed halfway to focus. The camera will track the subject while the shutter button is pressed halfway.
- While tracking is in progress, the in-focus indicator and AF target will be displayed. The target turns red if the camera can no longer track the subject. Press the shutter button again.
- Autofocus with manual adjustment is available when [C-AF+TR<sup>MF</sup>] is selected. Rotate the lens focus ring to interrupt autofocus and focus manually (P. 117).
- Tracking AF cannot be used with:
  - keystone compensation, High Res Shot, focus stacking, focus bracketing, interval timer photography, HDR photography, the live ND filter, or fisheye correction.

In-focus indicator



Target displayed while tracking is in progress

## Preset MF (PreMF)

Select [PreMF] to focus at a preset distance.  “Focusing at a Preset Distance (Preset MF)” (P. 129)



## **AF+MF (S-AF MF, C-AF MF, C-AF+TR MF)**



Manual focus adjustment is enabled. The method used to adjust focus depends on the AF mode. Manual focus is available when [On] is selected for [📷 AF+MF] in  Custom Menu **A1** (P. 481).

**S-AF MF:** After focusing using single AF, you can keep the shutter button pressed halfway and adjust focus manually. Alternatively, you can switch to manual focus by rotating the focus ring while the camera is focusing. Focus can also be adjusted manually while the shutter is open and during burst photography in [Sequential Low] mode.

**C-AF MF/C-AF+TR MF:** You can switch to manual focus while the camera is focusing in continuous AF and continuous tracking AF modes. Press the shutter button halfway a second time to refocus using autofocus. Focus can also be adjusted manually while the shutter is open and during burst photography in [Sequential Low] mode.

- Autofocus with manual focus is also available when autofocus is assigned to other camera controls.  [📷 AEL/AFL] (P. 141)
- The lens focus ring can be used to interrupt autofocus only when M.ZUIKO PRO (Micro Four Thirds PRO) lenses are used. For information on other lenses, visit the OLYMPUS website.
- In **B** (bulb) mode, manual focus is controlled by the option selected for [Bulb/Time Focusing].



- The beep can be muted and the AF target display changed in the  Custom Menu.  [AF Area Pointer] (P. 486), [🔊]] (P. 527)
- You can configure the camera to automatically zoom in on the focus target when the lens focus ring is rotated or to highlight outlines that are in focus.  [MF Assist] (P. 495)
- The following focus settings can be recalled simultaneously using the **Fn** lever. Separate settings can be assigned to Positions 1 and 2. Use this option to quickly adjust settings according to shooting conditions.

[AF Mode], [AF Target Mode] (P. 120), and [AF Target Point] (P. 123)

The **Fn** lever can be configured using [📷 Fn Lever Function] in  Custom Menu **B1** (P. 475).

## ■ Access via the AF Button

1 Press the AF  button.

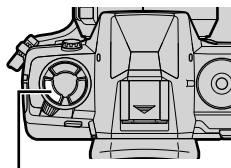

AF  button

- [  AF Mode ] options will be displayed.



[  AF Mode ] options

2 Rotate the rear dial.

- You can also rotate the dial while pressing the button.
- If [  AF+MF ] (P. 481) is [Off], only [S-AF], [C-AF], [MF], [C-AF+TR], and [PreMF] will be displayed.

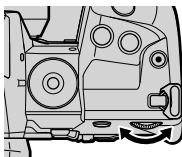

3 Press the shutter button halfway to exit to the shooting display.

## ■ Access via the LV Super Control Panel

The focus mode can also be selected using the LV super control panel.

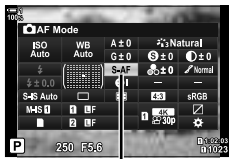

📷 AF mode

Press the **OK** button ➔ [📷 AF Mode] ➔ Rotate the front dial to choose an option

## ■ Menu Access

The focus mode can also be selected using [📷 AF Mode] in ⚙ Custom Menu **A1**.

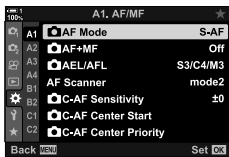

**MENU** button ➔ ⚙ tab ➔ **A1** tab ➔ [📷 AF Mode] ➔ Press **▶** on the arrow pad to display options ➔ Use the **△**/**▽** buttons to choose an option

## ■ Access via Live Controls

Highlight [📷 AF Mode] in the live controls and use **<>** on the arrow pad to choose an option.

- For information on displaying live controls, see “Using Live Controls” (P. 68).

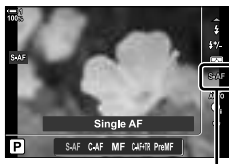

📷 AF mode

2

## Choosing an AF-Target Mode (AF Target Mode)

The point or area in the frame on which the camera focuses is called the "AF target". [AF Target Mode] is used to choose the number of AF targets used and the size of the area covered. Reducing the number of targets restricts focus to a small area of the frame, while increasing the number expands focus to a larger area. Choose [Single Target] for subjects that are easy to track, [Target Group] or [All Targets] for more elusive subjects.

- This setting can be accessed via:
  - The multi selector (P. 121)
  - The LV super control panel (P. 122)

### [ · ] Single Target

Select a single focus target.

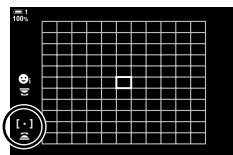

### [ · ]s Small Target

Further reduce the target size for single-target AF-target selection. Use for pinpoint focus on small subjects.

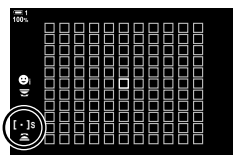

### [ ·· ] 5-Target Group

Select a group of 5 targets, arranged in a cross. The camera chooses the target used for focus from within the selected group.

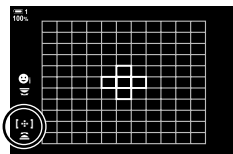

### [ ·· ] 9-Target Group (3 × 3)

Select a group of 9 targets, arranged in a square. The camera chooses the target used for focus from within the selected group.

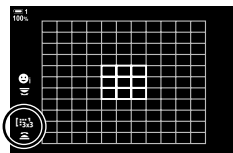

### [ ·· ] 25-Target Group (5 × 5)

Select a group of 25 targets, arranged in a square. The camera chooses the target used for focus from within the selected group.

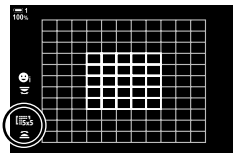

## ALL All Targets (11 × 11)

The camera chooses the target used for focus from all 121 targets.

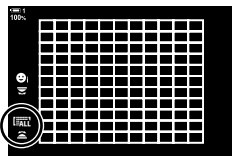

## [C1]/[C2]/[C3]/[C4] Custom Target

Use the AF target mode selected for [Target Mode Settings] (P. 125) in **Custom Menu A2**. The default setting is single target.

### ■ Access via the Multi Selector

- 1 Keep the multi selector pressed while rotating the front or rear dial.

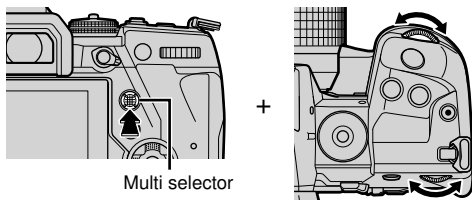

- The camera cycles through AF target modes as shown.

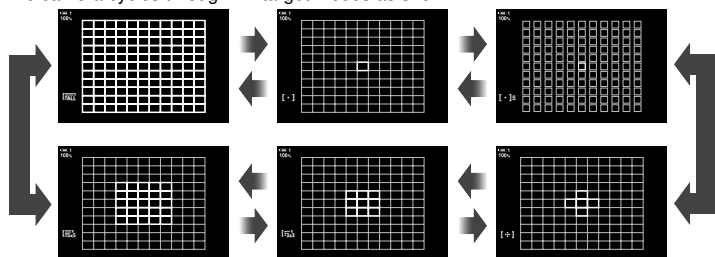

- At default settings, the custom target is not displayed. Display can be enabled using [Mode Settings] (P. 485).

- 2 Release the multi selector when the desired mode is displayed.

- AF target mode options will no longer be displayed.
- Assigning [AF-target selection] to the arrow pad or **Fn** button allows the arrow pad to be used for AF-target selection. Pressing the  $\Delta$   $\nabla$   $\triangleleft$   $\triangleright$  buttons displays the AF target. [AF-target selection] is assigned to the arrow pad by default.
- The following reduce the number of AF targets available:
  - Selecting [On] for [Digital Tele-converter] (P. 235)
  - Selecting an option other than [4:3] for [Image Aspect] (P. 233)



- The AF target display can be accessed using the multi selector. The multi selector can be configured using [OK] Center Button] in ⚙ Custom Menu **B1** (P. 499).
- Settings can be changed using the arrow pad. The role assigned to the arrow pad can be selected using [OK] Button Function] (P. 463) > [OK] (arrow pad) in ⚙ Custom Menu **B1**. At default settings, it is assigned to the **Fn** button.
- Separate AF target modes can be selected according to camera orientation.  
👉 [OK] Orientation Linked [:::] (P. 489)
- The following focus settings can be recalled simultaneously using the **Fn** lever. Separate settings can be assigned to Positions 1 and 2. Use this option to quickly adjust settings according to shooting conditions.  
[AF Mode], [AF Target Mode] (P. 120), and [AF Target Point] (P. 123)  
The **Fn** lever can be configured using [OK] Fn Lever Function] (P. 475) in ⚙ Custom Menu **B1**.
- You can adjust AF target settings for [C-AF]. 👉 [OK] C-AF Center Start] (P. 147) and [OK] C-AF Center Priority] (P. 148)
- Settings can also be adjusted by first pressing a button and then using the front dial. Access the AF-target display by pressing the control to which [:::] has been assigned via [OK] Button Function]. You can then adjust settings by rotating the front dial. At default settings, [:::] is assigned to the **Fn** button. 👉 [OK] Button Function] (P. 463)

2

## ■ Access via the LV Super Control Panel

- 1 After displaying the LV super control panel, highlight [AF Area] and press the **OK** button.



AF Area

- AF-target selection will be displayed.

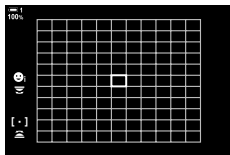

- 2 Rotate the front dial to choose an AF-target mode.

- You can choose the roles played by the front and rear dials or arrow pad during AF-target selection. Use [:::] Select Screen Settings] (P. 488) in ⚙ Custom Menu **A2**. At default settings, the front dial is used to choose the AF target mode.

- 3 Press the shutter button halfway to exit.

- To enable cluster AF targeting when [ALL] (all targets) is selected and [S-AF], [S-AF MF], [C-AF], or [C-AF MF] is chosen for [OK] AF Mode] (P. 115), select [On2] for [AF Area Pointer] (P. 486). The camera will display AF targets for all areas that are in focus.



The green frame showing the location of the focus point is referred to as the “AF target”. You can position the target over your subject. At default settings, the multi selector is used to position the AF target.

- AF-target selection is available when an option other than **ALL** (all targets) is selected for [AF Target Mode] (P. 120).
- This setting can be accessed via:
  - The multi selector
  - The LV super control panel (P. 124)

## ■ Access via the Multi Selector

**1** Use the multi selector to position the AF target.

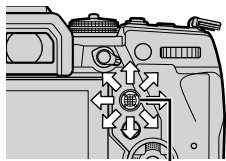

Multi selector

2

- The AF target is displayed in green at the start of the operation.
- To select the center AF target, press the multi selector or press and hold the **OK** button.

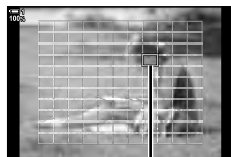

AF target

**2** Take pictures.

- The AF-target selection display will clear from the monitor.
- The AF frame is displayed in place of the selected AF target.
- Assigning **[:::]** (AF-target selection) to the arrow pad or **Fn** button allows the arrow pad to be used for AF-target selection. Pressing the **△ ▽ ◀ ▶** buttons displays the AF target. **[:::]** (AF-target selection) is assigned to the arrow pad by default.
- If you assign **[:::]** to a control using **[📷 Button Function]** (P. 463), you can press the control and then position the AF target using the multi selector or arrow pad. This option is assigned to the **Fn** button by default.
- In [C-AF] and [C-AF **MF**] modes, the AF target can be repositioned while focus is in progress.



- When [On] is selected for [AF Targeting Pad], you can reposition the AF target using monitor touch controls while framing your subject in the viewfinder. **[👉]** [AF Targeting Pad] (P. 486)

## ■ Access via the LV Super Control Panel

1 Highlight [AF Area] in the LV super control panel and press the **OK** button.

- AF-target selection will be displayed.
- The number of targets available varies with the AF target mode.



AF Area

2 Use the arrow pad ( $\Delta$   $\nabla$   $\triangleleft$   $\triangleright$ ) to position the AF target.

- The AF target can also be positioned by moving the multi selector.
- You can center the AF target by pressing the multi selector or by pressing and holding the **OK** button.
- You can choose the roles played by the front and rear dials or arrow pad during AF-target selection. Use [**⋮**] Select Screen Settings] (P. 488) in **Custom Menu** **A2**. At default settings, the arrow pad is used to position the AF target.

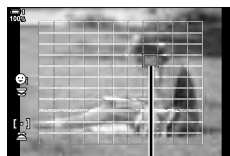

AF target

3 Press the shutter button halfway to exit to the shooting display.

- The following reduce the number of AF targets available:
  - Selecting [On] for [Digital Tele-converter] (P. 235)
  - Selecting an option other than [4:3] for [Image Aspect] (P. 233)



- You can disable the use of the multi selector in the shooting display. [Direction Key] (P. 499)
- Separate AF targets can be selected according to camera orientation. [Orientation Linked **⋮**] (P. 489)
- The following focus settings can be recalled simultaneously using the **Fn** lever. Separate settings can be assigned to Positions 1 and 2. Use this option to quickly adjust settings according to shooting conditions.

[AF Mode], [AF Target Mode] (P. 120), and [AF Target Point] (P. 123)

The **Fn** lever can be configured using [**Fn** Lever Function] (P. 475) in **Custom Menu** **B1**.



## Custom AF Targets (Target Mode Settings)

Choose the number of AF targets available and how far the AF target moves during AF target selection. Targets can be larger than group targets or sized for subjects whose motion can be predicted. You can also increase the distance between available targets for faster target selection. The camera can store up to four different combinations of settings.

<b>Size</b>	Choose the target size. Target width and height can be set separately. Choose from vertical and horizontal dimensions of 1, 3, 5, 7, 9, and 11.
<b>Step</b>	Choose the number of steps the target moves during target selection. The horizontal and vertical step sizes can be set separately; choose from steps of 1, 2, and 3.

1 Press the **MENU** button to display the menus.

2 Select **Custom Menu A2 (AF/MF)**.

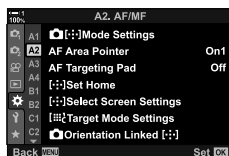

2

3 Highlight **[Target Mode Settings]** using **Δ ∇** on the arrow pad and press the **▷** button.

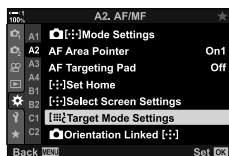

4 Use the **Δ ∇** buttons to highlight the destination for the custom target and press the **▷** button.

- Custom target options will be displayed.



## 5 Choose the size of the AF target.

- Highlight [Size] using the  $\Delta$   $\nabla$  buttons and press the **OK** button.



- Use the  $\triangleleft$   $\triangleright$  buttons or the front dial to choose the horizontal size and the  $\Delta$   $\nabla$  buttons or the rear dial to choose the vertical size.
- To exit without saving changes, press the **MENU** button.
- After choosing a size, press the **OK** to return to the custom target options for the selected group.

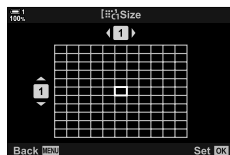

## 6 Choose the step size.

- Highlight [Step] using the  $\Delta$   $\nabla$  buttons and press the **OK** button.



- Use the  $\triangleleft$   $\triangleright$  buttons or the front dial to choose the horizontal step size and the  $\Delta$   $\nabla$  buttons or the rear dial to choose the vertical step size.
- To exit without saving changes, press the **MENU** button.
- Press the **OK** button when settings are complete.
- To save additional combinations, repeat Steps 4–6.

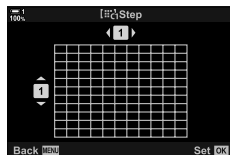

## 7 Press the **MENU** button repeatedly to exit the menus.

- At default settings, the custom target is not displayed. Display can be enabled using [CAMERA]Mode Settings] (P. 485).
- To use the custom target, select it in the AF-target mode selection display.  [AF Target Mode] (P. 120)



- AF-target settings for [C-AF] can be set separately for each custom target.  [CAMERA C-AF Center Start] (P. 147), [CAMERA C-AF Center Priority] (P. 148)

The “MF clutch” (manual focus clutch) mechanism on MF clutch lenses can be used to switch between auto and manual focus simply by repositioning the focus ring.

- Check the position of the focus ring before shooting.
- Sliding the focus ring to the AF/MF position at the end of the lens selects autofocus, while sliding it to the MF position closer to the camera body selects manual focus, regardless of the focus mode chosen with the camera.

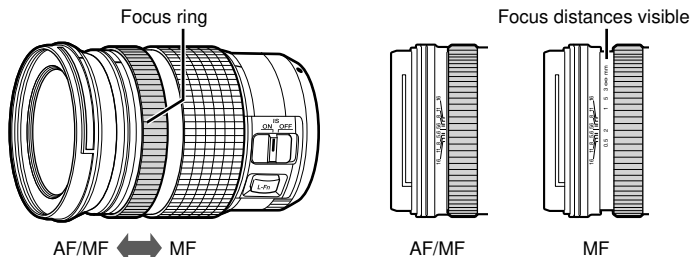

- Selecting [MF] or [PreMF] for focus mode on the camera disables autofocus even when the focus ring is in the AF/MF position.

## Disabling the MF Clutch

(MF Clutch)

Disable the manual focus clutch. This can prevent autofocus being disabled by the clutch engaging accidentally.



- 1 Press the **MENU** button to display the menus.
- 2 Select  Custom Menu **A4** (AF/MF).

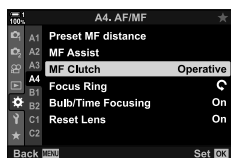

- 3 Highlight [MF Clutch] using  $\Delta$   $\nabla$  on the arrow pad and press the  $\blacktriangleright$  button.



2

- 4 Use the  $\Delta$   $\nabla$  buttons to highlight an option.  
[Operative]: The camera responds to the position of the lens focus ring.  
[Inoperative]: The camera focuses according to the option selected for  AF Mode], regardless of the position of the lens focus ring.
- 5 Press the **OK** button to select the highlighted option.
  -  Custom Menu **A4** will be displayed.
- 6 Press the **MENU** button repeatedly to exit the menus.

- Manual focus using the lens focus ring is not available when [Inoperative] is selected for [MF Clutch], even if the lens focus ring is in the manual focus position.

Quickly focus at a previously-stored distance. An example of a situation in which this option might be effective is astronomical photography featuring the moon or stars, when you want to focus quickly at infinity. The focus distance can be set using AF/MF or by entering the focus distance directly.

If the lens is equipped with a focus limiter, disable it before proceeding.

- The figures displayed are intended as guides only.
- This setting can be accessed via:
  - The **AF** button
  - The LV super control panel (P. 131)
  - The menus (P. 131)
  - Live controls (P. 131)



- [PreMF] (preset MF) can be assigned to a camera control using [Camera Button Function] in Custom Menu **B1**, allowing you to focus at a preset distance at the touch of a button (P. 463).
- The following focus settings can be recalled simultaneously using the **Fn** lever. Separate settings can be assigned to Positions 1 and 2. Use this option to quickly adjust settings according to shooting conditions.

[AF Mode], [AF Target Mode] (P. 120), and [AF Target Point] (P. 123)

The **Fn** lever can be configured using [Camera Fn Lever Function] in Custom Menu **B1** (P. 475).

## ■ Access via the AF button

**1** Press the **AF** button.

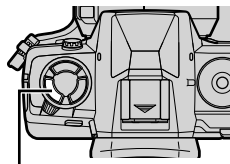

AF button

- [Camera AF Mode] options will be displayed.



[Camera AF Mode] options

2 Highlight [Preset MF] using the rear dial.



3 Press the **INFO** button.

- You will be prompted to choose the focus distance for [Preset MF].

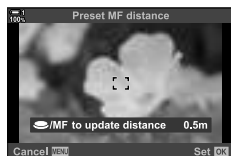

4 Choose a focus distance.

- To choose a focus distance using autofocus:  
Press the shutter button halfway to focus on a subject at the desired distance.



- To choose a focus distance using manual focus:  
Rotate the lens focus ring and check the distance in the display.



5 Press the **OK** button to accept the selected focus distance.

- To focus at the distance selected for [Preset MF distance], select [Preset MF] for [AF Mode] (P. 115).
- The camera also focuses at the preset distance:
  - when turned on and
  - when you exit the menus to the shooting display.

## ■ Access via the LV Super Control Panel

Highlight [📷 AF Mode] > [PreMF] in the LV super control panel, press the **OK** button, and then press the **INFO** button to display options. You can then press the shutter button halfway to focus on a subject at the desired distance, or choose the focus distance manually by rotating the focus ring.

- The camera will focus at the selected distance whenever you select [PreMF] for [📷 AF Mode].

## ■ Menu Access

Choose a focus distance using [Preset MF distance] in

⚙ Custom Menu **A4**.

- [Preset MF distance] can be used to select the units for the focus distance display; choose from [m] or [ft].
- To focus at the distance selected for [Preset MF distance], select [Preset MF] for [📷 AF Mode] (P. 115).

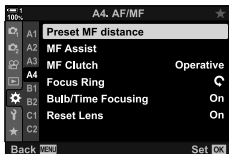

**MENU** button → ⚙ tab → **A4** tab → [Preset MF distance] → Press ▷ on the arrow pad to display options → Use the △ ▽ ◀▶ buttons to choose a focus distance and distance units

## ■ Access via Live Controls

Select [📷 AF Mode] > [PreMF] in the live controls and press the **INFO** button to display the preset focus distance. You can then press the shutter button halfway to focus on a subject at the desired distance, or choose the focus distance manually by rotating the focus ring.

- For information on displaying live controls, see “Using Live Controls” (P. 68).

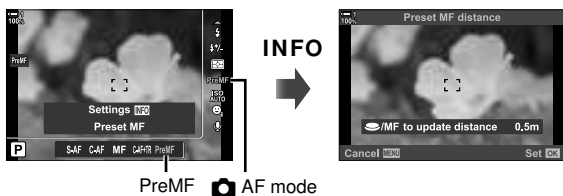

## ■ Using [Preset MF]

- 1 Choose a focus distance using [Preset MF].
  - For information on choosing a focus distance, see page 129.
- 2 Highlight [📷 AF Mode] in the LV super control panel.



📷 AF mode





- 3 Select [PreMF] (preset MF) using the front dial.
  - The camera will focus at the selected distance.
  - You can also adjust focus manually by rotating the focus ring.



## Face/Eye Priority AF

The camera automatically detects and focuses on the faces or eyes of portrait subjects. When digital ESP metering is used, exposure will be weighted according to the value metered for the face.

- This setting can be accessed via:
  - The LV super control panel
  - Live controls (P. 134)
  - The menus (P. 134)

 (face priority on)	The camera detects and focuses on faces.
 (face priority off)	Face priority AF off.
 (face and eye priority)	The camera detects faces and focuses on the eye closest to the camera.
 (face and right eye priority)	The camera detects faces and focuses on the right eye.
 (face and left eye priority)	The camera detects faces and focuses on the left eye.



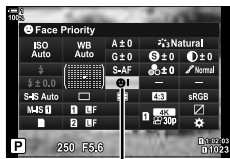

- Face/eye priority is unavailable if [[:]] Spot Metering] (P. 537) is selected during [ ] (spot) metering (P. 186) in single-target AF-target mode (P. 120).
- Face/eye priority will be disabled if an option other than [Off] is selected for [ Tracking Subject] in [ Custom Menu ] when tracking AF (C-AF+TR or C-AF+TR MF) is enabled (P. 116).

### ■ Access via the LV Super Control Panel

- 1 Highlight [ Face Priority] in the LV super control panel and press the **OK** button.



 face priority

- 2 Highlight an option using   on the arrow pad.
  - 3 Press the shutter button halfway to select the highlighted option and exit the LV super control panel.
- Assigning [[:]] (AF-target selection) to the arrow pad or **Fn** button allows the arrow pad to be used for AF-target selection. Press the    buttons and use the rear dial to choose a target. [[:]] (AF-target selection) is assigned to the arrow pad by default.

## ■ Menu Access

Choose an option using [☺ Face Priority] in ⚙ Custom Menu **A3**.

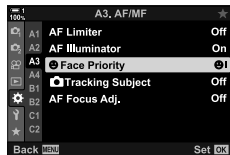

**MENU** button → ⚙ tab → **A3** tab → [☺ Face Priority] → Press ▷ on the arrow pad to display options → Use the △ ▽ buttons to choose an option

## ■ Access via Live Controls

Highlight [☺ Face Priority] in the live controls and use ◀▶ on the arrow pad to choose an option.

- For information on displaying live controls, see “Using Live Controls” (P. 68).
- You can also select face/eye priority by rotating the rear dial in the AF-target selection display.



☺ face priority



These settings can also be accessed using the following methods.

- Highlight [AF Area] in the LV super control panel and press the **OK** button. You can then adjust settings by rotating the rear dial.
- Access the AF-target display by pressing the control to which [[::]] has been assigned via [📷 Button Function]. You can then adjust settings by rotating the rear dial. At default settings, [[::]] is assigned to the **Fn** button.

## Using Face/Eye Priority AF

- 1 Point the camera at your subject.
  - Faces detected by the camera are indicated by white borders.



- 2 Press the shutter button halfway to focus.
  - The area of the subject used for focus is indicated by a green border.
  - If the camera detects the subject's eyes, it will focus on an eye.
  - A white border is also displayed if a face is detected during manual focus. Exposure will be set according to the value metered for the center of the face.

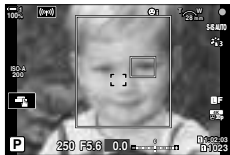

- 3 Press the shutter button all the way down.
  - The camera may fail to detect some subjects.
  - The camera may be unable to detect the subject depending on the settings selected for the [Picture Mode] art filter options (ART1–ART16).
  - If the zoom frame is displayed, the camera will focus on the subject in the zoom frame.

## Zoom Frame/Focus Zoom AF (Super Spot AF)

You can zoom in on the display during shooting. For greater precision during focusing, zoom in on the focus area. At higher zoom ratios, you can focus on areas smaller than the standard focus target. You can reposition the focus area as desired during zoom.

### Assigning [Q] (Magnify) to a Control

Focus zoom can be assigned to a control via:

- The LV super control panel
- The menus (P. 137)

#### ■ Access via the LV Super Control Panel

1 Highlight [📷 Button Function] in the LV super control panel and press the **OK** button.

- [📷 Button Function] options will be displayed.

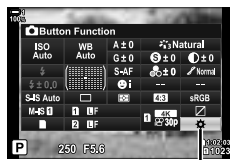

📷 button function

2 Using  $\Delta$ / $\nabla$  on the arrow pad, highlight the control to which [Q] (magnify) will be assigned and then press the  $\triangleright$  button.

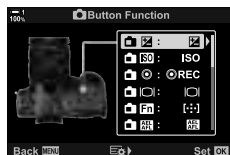

3 Highlight [Magnify] using the  $\Delta$ / $\nabla$  buttons and press the **OK** button.



4 Press the **OK** button again.

- The menu will clear from the display.

## ■ Menu Access

Use [📷 Button Function] in ⚙ Custom Menu **B1** to choose the roles played by camera controls.



**MENU** button → ⚙ tab → **B1** tab → [📷 Button Function] → Choose a control → Press ▷ on the arrow pad to display options → Use the △ ▽ buttons to choose [Q] (magnify)

## Using [Q] (Magnify)

- 1 Press the button to which [Q] (magnify) is assigned.
  - The zoom frame will be displayed.
  - The frame is displayed in the same position as the target most recently used for autofocus.

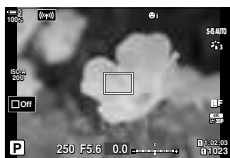

- 2 Position the frame using the multi selector.
  - To re-center the frame, press the multi selector or press and hold the **OK** button.
  - The frame can also be positioned using the arrow pad (△ ▽ <|>).

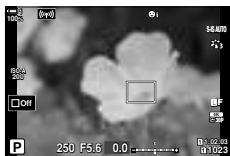

- 3 Adjust the size of the zoom frame to choose the zoom ratio.
  - Press the **INFO** and then use the △ ▽ buttons or the front or rear dial to adjust the size of the zoom frame.
  - Press the **OK** button to accept and exit.

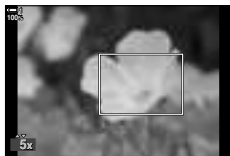

2

#### 4 Press the button to which [Q] is assigned once more.

- The camera will zoom the selected area in to fill the display.
- Use the multi selector to scroll the display.
- Use the front or rear dial to zoom in or out.
- You can also scroll the display using the arrow pad ( $\Delta \nabla \triangleleft \triangleright$ ).
- In shooting mode **M** (manual) or **B** (bulb), you can press the **INFO** button during zoom to choose aperture or shutter speed.
- Press the **Q** button to return to the zoom frame.
- Press the **OK** button to end focus zoom.
- You can also end focus zoom by pressing and holding the **Q** button.

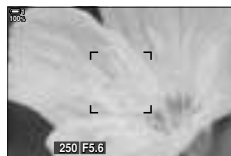
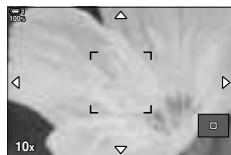

Exposure adjustment display for modes **M** and **B**

#### 5 Press the shutter button halfway to focus using autofocus.

- Focus zoom applies to the display only. Pictures taken with the camera are not affected.



- Touch controls can be used for focus zoom. Tap your subject in the display. The zoom frame will be displayed; tap **Q** to zoom in.
- You can make the area in the zoom frame brighter for easier focus or configure the camera to exit focus zoom when the shutter button is pressed halfway to focus.  [LV Close Up Settings] (P. 139)

Choose display options for use with focus zoom. This item comes in handy when you want to view the entire composition before shooting or if you want an easy-to-see display for checking focus with focus zoom.

<b>LV Close Up Mode</b>	<p>Choose what happens if the shutter button is pressed halfway during focus zoom.</p> <p>[mode1]: Focus zoom ends. You can check the composition after focusing using focus zoom.</p> <p>[mode2]: Focus zoom remains in effect while the camera focuses. Compose the shot before focusing, then zoom in for precise focus and take a picture without ever ending zoom.</p>
<b>Live View Boost</b>	<p>Adjust the brightness of the area in the zoom frame.</p> <p>[On]: The area in the zoom frame brightens for ease of viewing. Use for a clearer focus display during macro photography or the like.</p> <p>[Off]: Display brightness does not change. Exposure can be previewed during focus zoom.</p> <ul style="list-style-type: none"> <li>This item is available when [Off] is selected for [Live View Boost] in <b>Custom Menu D2</b> (P. 521).</li> </ul>

1 Press the **MENU** button to display the menus.

2 Select **Custom Menu D2** (Disp/PC).

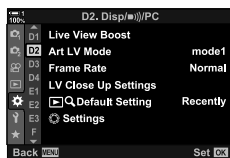

3 Highlight [LV Close Up Settings] using  $\Delta$   $\nabla$  on the arrow pad and press the  $\triangleright$  button.

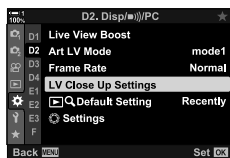

4 Highlight [LV Close Up Mode] or [Live View Boost] using the  $\Delta$   $\nabla$  buttons and press the  $\triangleright$  button.

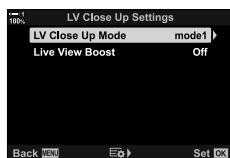

**5** Highlight an option using the  $\Delta$   $\nabla$  buttons and press the **OK** button.

- The [LV Close Up Settings] menu will be displayed.

**6** Press the **OK** button to accept the changes.

- $\star$  Custom Menu  $\square$  will be displayed.

**7** Press the **MENU** button repeatedly to exit the menus.

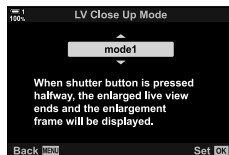



# Setting Focus and Exposure with the AEL/AFL Button

Choose how the camera sets focus and exposure when the shutter button or **AEL/AFL** button is pressed. The camera normally focuses and locks exposure when the shutter button is pressed halfway, but this can be changed according to the subject or shooting conditions.

<b>S-AF</b>	Choose options for each  focus mode.
<b>C-AF</b>	S-AF: [S-AF] or [S-AF <b>MF</b> ] C-AF: [C-AF], [C-AF <b>MF</b> ], [C-AF+TR], or [C-AF+TR <b>MF</b> ]
<b>MF</b>	MF: [MF] or [PreMF]
<b>Half Way AF</b>	Choose whether the camera focuses when the shutter is pressed halfway.  [Operative]: Pressing the shutter button halfway initiates autofocus regardless of whether autofocus is currently assigned to the <b>AEL/AFL</b> button. In [C-AF] mode, the last button pressed is used to maintain focus. This option has no effect in [MF] mode.  [Inoperative]: Pressing the shutter button halfway will not initiate autofocus if autofocus is currently assigned to the <b>AEL/AFL</b> button.

The table below shows how this setting interacts with [Half Way AF].

- "1" indicates the operation performed when [Half Way AF] is enabled, "2" the operation performed when it is disabled.

AEL/AFL mode		Shutter button pressed				AEL/AFL button	
		Halfway		All the way down		Kept pressed	
		AF	AE	AF	AE	AF	AE
S-AF	mode1	S-AF	Locks	—	—	—	Locks
	mode2	S-AF	—	—	Locks	—	Locks
	mode3	1: S-AF 2: —	Locks	—	—	S-AF	—
C-AF	mode1	C-AF	Locks	Ends	—	—	Locks
	mode2	C-AF	—	Ends	Locks	—	Locks
	mode3	1: C-AF 2: —	Locks	Ends	—	C-AF	—
	mode4	1: C-AF 2: —	—	Ends	Locks	C-AF	—
MF	mode1	—	Locks	—	—	—	Locks
	mode2	—	—	—	Locks	—	Locks
	mode3	—	Locks	—	—	S-AF	—

- 1 Press the **MENU** button to display the menus.
- 2 Highlight the  (Custom Menu) tab using  $\Delta$   $\nabla$  on the arrow pad and press the  $\triangleright$  button.

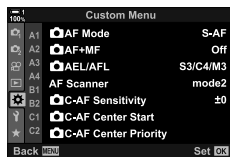

- 3 Select  Custom Menu **A1** (AF/MF).

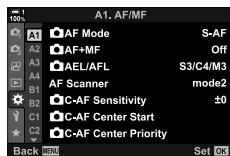

- 4 Highlight [ AEL/AFL] using the  $\Delta$   $\nabla$  buttons and press the  $\triangleright$  button.

2

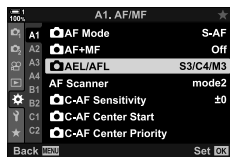

- 5 Highlight a focus mode using the  $\Delta$   $\nabla$  buttons and press the  $\triangleright$  button.
  - Choose from [S-AF], [C-AF], and [MF].
  - To adjust settings for [Half Way AF], select [Half Way AF].

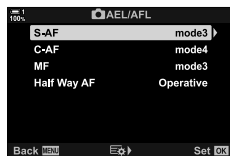



- 6 Highlight an option using the  $\Delta$   $\nabla$  buttons and press the **OK** button.
  - The focus mode selection menu will be displayed.



- 7 Press the **MENU** button repeatedly to exit the menus.



- The function performed by the **AEL/AFL** button can also be assigned to other buttons. Use [ Button Function] (P. 463) in  Custom Menu **B1**. At default settings, the **AEL/AFL** button is used.

Choose the range in which the camera will focus using autofocus. This is effective in situations in which an obstacle presents itself between the subject and the camera during the focus operation, causing drastic changes in focus. You can also use it to prevent the camera focusing on foreground objects when shooting through a fence, window, or the like.

If the lens is equipped with a focus limiter, disable it before proceeding.

<b>Distance settings</b>	Choose the range of focus distances available. The camera can store up to three settings for different situations. The distances shown are intended as guides only.
<b>Release Priority</b>	The shutter can still be released if subject is outside the selected range when [On] is selected for [AF Limiter].

**1** Press the **MENU** button to display the menus.

**2** Select **⚙ Custom Menu A3 (AF/MF)**.



**3** Highlight [AF Limiter] using **Δ ∇** on the arrow pad and press the **▷** button.

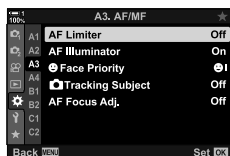

**4** Highlight [On] using the **Δ ∇** buttons and press the **▷** button.



**5** Highlight [Distance settings] using the **Δ ∇** buttons and press the **▷** button.

- A list of stored focus settings will be displayed.



- 6** Highlight the desired setting ([Setting 1]–[Setting 3]) using the  $\Delta$   $\nabla$  buttons and press the  $\triangleright$  button.
- Lens focus range options will be displayed.

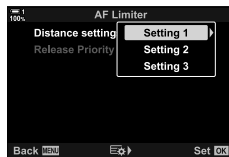

- 7** Choose a range using the arrow pad.
- Press the  $\Delta$   $\nabla$  buttons to choose a number and then press the  $\triangleright$  button to highlight the next digit.
  - The units used can be selected from [m] or [ft].



- 8** After choosing a focus range, press the **OK** button.
- The list of stored focus settings will be displayed.

- 9** Press the **OK** button again to return to the AF limiter display and then highlight [Release Priority] using the  $\Delta$   $\nabla$  buttons and press the  $\triangleright$  button.
- Release priority options will be displayed.

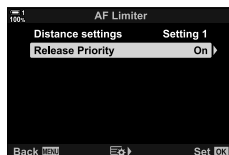

- 10** Highlight an option using the  $\Delta$   $\nabla$  buttons and press the **OK** button.
- [AF Limiter] options will be displayed.

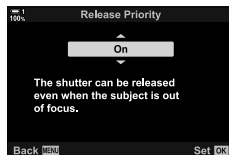

- 11** Press the **OK** button repeatedly to return to the custom menu.
- Press the **MENU** button one more time to exit the menu.
  - The options chosen for [S-AF Release Priority] and [C-AF Release Priority] in  $\star$  Custom Menu **C1** have no effect when [On] is selected for [Release Priority].



- If [AF Limiter] is assigned to a button using [Camera Button Function] (P. 463), the selected distance can be recalled by pressing the button and rotating the front or rear dial.

## C-AF Tracking Sensitivity (📷 C-AF Sensitivity)

Choose how rapidly the camera responds to changes in the distance to the subject while focusing with [C-AF], [C-AF MF], [C-AF+TR], or [C-AF+TR MF] selected for [📷 AF Mode]. This can help autofocus track a quickly-moving subject or prevent the camera refocusing when an object passes between the subject and the camera.

- Choose from five levels of tracking sensitivity.
- The higher the value, the higher the sensitivity. Choose positive values for subjects that suddenly enter the frame, that are moving rapidly away from the camera, or that change speed or stop suddenly while moving toward or away from the camera.
- The lower the value, the lower the sensitivity. Choose negative values to prevent the camera refocusing when the subject is briefly obscured by other objects or to prevent the camera focusing on the background when you are unable to keep the subject in the AF target.

1 Press the **MENU** button to display the menus.

2 Select **⚙️** Custom Menu **A1** (AF/MF).

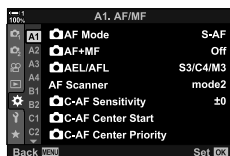

2

3 Highlight [📷 C-AF Sensitivity] using **△**/**▽** on the arrow pad and press the **▶** button.

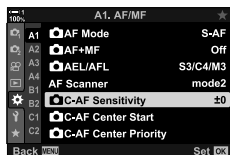

4 Highlight a setting using the **△**/**▽** buttons and press the **OK** button.

- **⚙️** Custom Menu **A1** will be displayed.

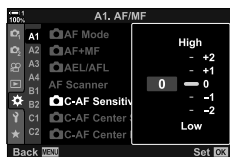

5 Press the **MENU** button repeatedly to exit the menus.

Choose whether the camera performs a focus scan. If the camera is unable to focus, it will scan for the focus position by cycling the lens from the minimum focus distance to infinity. You can limit the scanning operation if desired. This option takes effect when [C-AF], [C-AF+TR], [C-AF **MF**], or [C-AF+TR **MF**] is selected for [📷 AF Mode] (P. 115).

<b>mode1</b>	The camera will not scan if unable to focus. This prevents focus changing to such an extent that you lose sight of your subject when attempting to track small objects and the like.
<b>mode2</b>	When unable to focus, the camera scans only once. The camera will not scan again as long as the focus operation continues.
<b>mode3</b>	The camera scans when unable to focus, cycling focus as often as necessary if it loses track of the subject during the focus operation.

1 Press the **MENU** button to display the menus.

2 Select **⚙️ Custom Menu A1 (AF/MF)**.

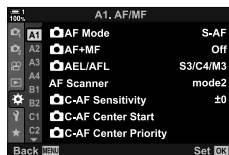

3 Highlight [AF Scanner] using **Δ ∇** on the arrow pad and press the **▶** button.

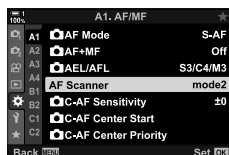

4 Highlight an option using the **Δ ∇** buttons and press the **OK** button.

- **⚙️ Custom Menu A1** will be displayed.

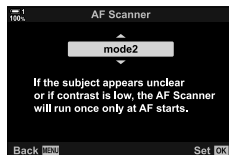

5 Press the **MENU** button repeatedly to exit the menus.

- Regardless of the option selected, the camera will scan once if unable to focus when [S-AF] or [S-AF **MF**] is selected for [📷 AF Mode].

## C-AF Starting Focus Target

### C-AF Center Start

When used in combination with an AF-target mode other than single target, [C-AF] and [C-AF MF] focus on the center of the selected group only during the initial scan. During later scans, the camera will focus using the surrounding targets. Combining this option with an AF-target mode that covers a wide area makes it easier to focus on erratically-moving subjects.

- 1 Press the **MENU** button to display the menus.
- 2 Select  Custom Menu **A1** (AF/MF).

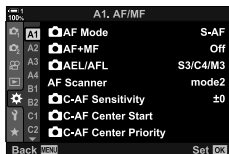

- 3 Highlight [ C-AF Center Start] using  $\Delta$   $\nabla$  on the arrow pad and press the  $\triangleright$  button.

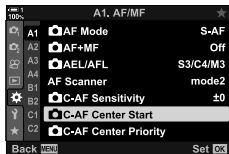

- 4 Using the  $\Delta$   $\nabla$  buttons, highlight the AF target modes to which [ C-AF Center Start] will apply and then press the **OK** button.
  - Selected modes are marked with a  $\checkmark$ . To deselect, press the **OK** button again.



- 5 Press the **MENU** button repeatedly to exit the menus.

- This option is not available when [ C-AF Center Priority] (P. 148) is enabled.

2

## C-AF Center Target Priority

### C-AF Center Priority

When focusing using group-target AF in [C-AF] and [C-AF MF] modes, the camera always assigns priority to the center target in the selected group for a repeated series of focus operations. Only if the camera is unable to focus using the center focus target will it focus using the surrounding targets in the selected focus group. This helps you track subjects that are moving quickly but relatively predictably. Center priority is recommended in most situations.

1 Press the **MENU** button to display the menus.

2 Select  Custom Menu **A1** (AF/MF).

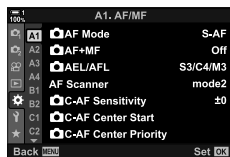

2  
3 Highlight [ C-AF Center Priority] using  $\Delta$   $\nabla$  on the arrow pad and press the  $\triangleright$  button.

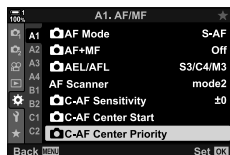

4 Using the  $\Delta$   $\nabla$  buttons, highlight the AF target modes to which [ C-AF Center Priority] will apply and then press the **OK** button.

- Selected modes are marked with a . To deselect, press the **OK** button again.



5 Press the **MENU** button repeatedly to exit the menus.



# Tracking Focus on Selected Subjects

## Tracking Subject

The camera can detect and track subjects of specific types when focusing using [C-AF+TR] or [C-AF+TR MF]. You may find it hard to focus on the driver or cockpit of a fast-moving subject such as a race car or airplane. This feature detects and focuses specific elements of such subjects.

<b>Motorsports</b>	The camera detects cars or motorcycles. It tracks focus on such elements as the chassis (chiefly of types used in motor sports) or driver.
<b>Airplanes</b>	The camera detects planes and helicopters. It tracks focus on such elements as the fuselage or cockpit.
<b>Trains</b>	The camera detects trains. It tracks focus on such elements as the cars or driver's compartment.
<b>Off</b>	Tracking subject selection disabled.

- Selecting an option other than [Off] automatically sets face/eye detection to [Off].
- The following cannot be used while photography is in progress:  
the live ND filter, interval-timer or HDR photography, keystone compensation, fisheye correction, High Res Shot, focus bracketing, or Pro Capture High

2

1 Press the **MENU** button to display the menus.

2 Select  Custom Menu **A3** (AF/MF).

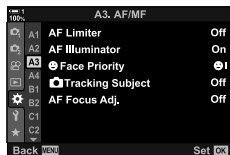

3 Highlight [ Tracking Subject] using  $\Delta$   $\nabla$  on the arrow pad and press the  $\triangleright$  button.

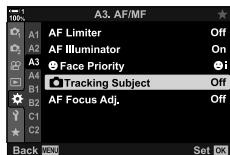

4 Highlight an option using the  $\Delta$   $\nabla$  buttons and press the **OK** button.

- To disable this feature, select [Off].
-  Custom Menu **A3** will be displayed.



5 Press the **MENU** button repeatedly to exit the menus.

- 6** To use this feature, select [C-AF+TR] or [C-AF+TR] **MF** for [📷 AF Mode].
- The focus mode can be selected using the menus or LV super control panel.



## ■ Taking Photographs Using [📷 Tracking Subject]

- 1** Select [C-AF+TR] or [C-AF+TR] **MF** for [📷 AF Mode].
- 2** Point the camera at your subject.
  - When detected, subjects of the type selected for [📷 Tracking Subject] are shown by white frames.

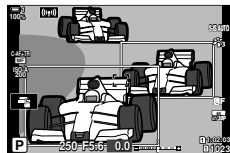

- 2**
- 3** Press the shutter button halfway to focus.
    - When an element such as the driver, cockpit, or driver's compartment is detected, a subject tracking indicator will be displayed.
    - If multiple subjects are detected, the camera will focus on the subject in the AF frame.
  - 4** Press the shutter button the rest of the way down to take the picture.

- The camera may fail to detect the subject depending on the subject or art filter selected.
- The camera may fail to detect the subject depending on its type or on shooting conditions.

## 2-10 Drive Mode















Your choice of drive mode determines what happens when the shutter button is pressed, for example whether the camera takes a series of pictures while the button is pressed or starts a timer and takes a picture after a delay.







Choose an option that suits your goals, whether they are to capture subject motion in a series of photos or take photos that record changes in your subject over a long period of time. Drive mode can be effectively combined with other settings to photograph a variety of subjects under different shooting conditions.

- This setting can be accessed via:
  - The  button (P. 153)
  - The LV super control panel (P. 154)
  - The menus (P. 154)
  - Live controls (P. 154)



### Sequential Shooting/Self-Timer

Adjust settings for burst or self-timer photography. Choose an option according to your subject.

 <b>Single</b>	Single-frame advance. The camera takes one photo each time the shutter button is pressed all the way down.
 <b>Sequential High</b>	The camera takes photos at up to about 15 fps while the shutter button is held all the way down. Focus, exposure, and white balance are locked at the values for the first shot in each series. You can choose the frame advance rate and the maximum number of shots in each series (P. 155). The frame advance rate drops at  ISO settings over 8000.
 <b>Sequential Low</b>	The camera takes photos at up to about 10 fps while the shutter button is held all the way down. You can choose the frame advance rate and the maximum number of shots in each series (P. 155). Focus and exposure conform to the options selected for  AF Mode] (P. 115) and  AEL/AFL] (P. 141). If [C-AF], [C-AF  MF], [C-AF+TR], or [C-AF+TR  MF] is selected for  AF Mode], the camera will focus before each shot. The frame advance rate drops at  ISO settings over 8000.
  <b>12sec</b>	The shutter is released 12 s after the shutter button is pressed all the way down. The self-timer lamp will light for about 10 s and then start to flash about 2 s before the shutter is released. The camera focuses when the shutter button is pressed halfway.
  <b>2sec</b>	When the shutter button is pressed all the way down, the self-timer lamp will start to flash and a photo will be taken after about 2 seconds. The camera focuses when the shutter button is pressed halfway.

	<b>Custom Self-Timer</b>	Adjust self-timer settings, including the self-timer delay and the number of shots taken when the timer expires (P. 157).
 (sample icon)	<b>Anti-Shock [♦]</b>	Reduce the slight blur caused by shutter motion. The electronic front-curtain shutter is used. Available in single-frame, sequential low, and self-timer modes (P. 160).
 (sample icon)	<b>Silent [♥]</b>	Take pictures with the electronic shutter. Use for shutter speeds faster than 1/8000 s or in settings where the sound of the shutter would be unwelcome. Available in single-frame, sequential low, sequential high, and self-timer modes. Frame advance rates of up to 60 fps are available when sequential high is selected (P. 163). In ♥ mode, focus, exposure, and white balance are locked at the values for the first shot in each series. The flash sync speed is 1/50 s. At [📷] ISO settings over ISO 8000, the flash sync speed drops to 1/20 s and the maximum frame advance rate to 30 fps.
	<b>Pro Capture High</b>	Capture starts when the shutter button is pressed halfway. The camera starts recording pictures, including those captured while the button was pressed halfway, when the button is pressed all the way down (P. 168). In 📷 mode, focus, exposure, and white balance are locked at the values metered when the shutter button is pressed halfway. At [📷] ISO settings over ISO 8000, the maximum frame advance rate drops to 30 fps.
	<b>Pro Capture Low</b>	
	<b>High Res Shot</b>	Take high-resolution photos. Hand-held photography is supported (P. 210).

2

- Some drive modes are not displayed by default. Use [📷/📷] Settings] (P. 520) in  Custom Menu  to choose the modes displayed.
- To cancel the self-timer before shooting starts, press ▽ on the arrow pad.
- Mount the camera securely on a tripod for self-timer photography.
- Standing in front of the camera while operating the shutter button in self-timer mode could cause photos to be out of focus.
- In 📷 and 📷 modes, the view through the lens is shown during shooting. In 📷 and 📷 modes, the camera shows a shot taken immediately before shooting starts.
- The frame advance rate varies with the lens and zoom position.
- If the battery indicator starts to flash while burst shooting is in progress, the camera will stop shooting and start recording photos to the memory card. Some photos may not be recorded depending on the charge remaining.
- Fast-moving subjects and violent camera motion may cause distortion in photos taken in silent and Pro Capture modes.
- To use the flash in [Silent [♥]] mode, select [Allow] for [Silent [♥] Mode Settings] > [Flash Mode] (P. 167).
- The frame advance rate may slow when [On1] or [On2] is selected for [Live View Boost]. Select [Off] to maintain a consistent frame rate.  [Live View Boost] (P. 200)

## ■ Access via the Button

Direct drive mode selection is available via the  button.

1 Press the  button.

- [] (sequential shooting/self-timer) options will be displayed.

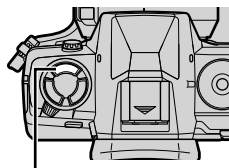

 button



[] (sequential shooting/self-timer) options

2 Rotate the rear dial to highlight an option.

- Custom self-timer or high-res shot options can be viewed by pressing the **INFO** button.



3 Press the shutter button halfway to select the highlighted option and exit.

- You can also highlight options by holding the  button and rotating the front or rear dial. Releasing the button selects the highlighted option and returns you to the shooting display.

2

## ■ Access via the LV Super Control Panel

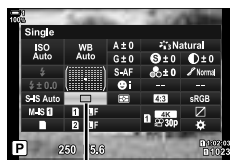

- 1 Highlight  (sequential shooting/self-timer) in the LV super control panel.









 (sequential shooting/self-timer)

- 2 Rotate the front dial to choose an option.
- 3 Press the shutter button halfway to return to the shooting display.



## ■ Menu Access

Use  (drive mode) >  (sequential shooting/self-timer) in  Shooting Menu 1.



**MENU** button →  tab →  →  → Press  on the arrow pad to view options → Use the   buttons to choose an option

## ■ Access via Live Controls

Highlight  (sequential shooting/self-timer) in the live controls and press   on the arrow pad to choose an option.

- For information on displaying live controls, see “Using Live Controls” (P. 68).



















 (sequential shooting/self-timer)







# Burst Shooting Options

## (L Settings/H Settings)

Choose the maximum frame advance rates and shots per burst for sequential shooting modes. Shooting ends if the maximum number of shots is reached while the shutter button is pressed all the way down.

Choose the advance rate and number of shots per burst for  (sequential low) and  (sequential high) modes. For information on Pro Capture modes, see “Reducing Shutter Lag (Pro Capture Photography)” (P. 168).

 L Settings (sequential low options)	<p>Choose the frame rate and maximum number of shots per burst for  (sequential low),  (anti-shock sequential low), and  (silent sequential low) modes. You can also adjust settings for  (Pro Capture Low) mode (P. 168).</p> <ul style="list-style-type: none"><li>•  and  modes: [Max fps]: 1–10 fps [Frame Count Limiter]: 2–99, Off (no limit)</li><li>•  mode: [Max fps]: 1–18 fps [Frame Count Limiter]: 2–99, Off (no limit)</li></ul>
 H Settings (sequential high options)	<p>Choose the frame rate and maximum number of shots per burst for  (sequential high) and  (silent sequential high) modes. You can also adjust settings for  (Pro Capture High) mode (P. 168).</p> <ul style="list-style-type: none"><li>•  mode: [Max fps]: 10–15 fps [Frame Count Limiter]: 2–99, Off (no limit)</li><li>•  mode: [Max fps]: 15, 20, 30, or 60 fps [Frame Count Limiter]: 2–99, Off (no limit)</li></ul>

- 1 Press the **MENU** button to display the menus.
- 2 Display  Custom Menu **C1** (Release//Image Stabilizer).
- 3 Highlight [L Settings] or [H Settings] using   on the arrow pad and press the  button.

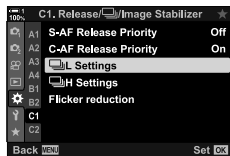

**4** Highlight [⏏/♦⏏], [♥⏏], or [Pro Cap] using the  $\Delta$   $\nabla$  buttons and press the  $\triangleright$  button.

- The camera will display options for the selected item.

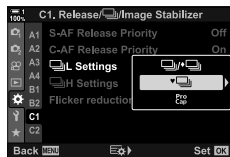

**5** Choose a setting for [Max fps].

- Highlight [Max fps] using the  $\Delta$   $\nabla$  buttons and press the  $\triangleright$  button.
- Highlight an option using the  $\Delta$   $\nabla$  buttons and press the **OK** button.

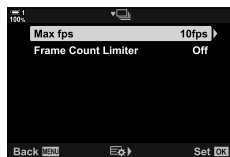

**6** Choose a setting for [Pre-shutter Frames].

- This option will only be available if you selected [Pro Cap] in Step 4.
- Highlight [Pre-shutter Frames] using the  $\Delta$   $\nabla$  buttons and press the  $\triangleright$  button.
- Highlight an option using the  $\Delta$   $\nabla$  buttons and press the **OK** button.
- To disable pre-capture, select [0].

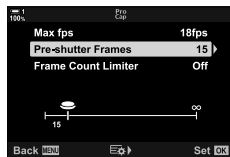

**7** Choose the maximum number of shots per burst ([Frame Count Limiter]).

- Highlight [Frame Count Limiter] using the  $\Delta$   $\nabla$  buttons and press the  $\triangleright$  button.
- To keep shooting as long as the shutter release button is pressed all the way down, select [Off].
- To choose a maximum number of shots, highlight the current setting and press the  $\triangleright$  button to display options. Highlight digits using the  $\triangleleft$   $\triangleright$  buttons and use the  $\Delta$   $\nabla$  buttons to change.
- The maximum number of shots per burst includes shots captured while the shutter button is pressed halfway.  
 "Reducing Shutter Lag (Pro Capture Photography)" (P. 168)
- Press the **OK** button to save changes to settings.

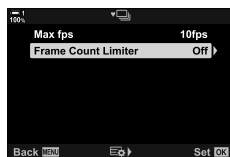

**8** Press the **OK** button.

- Custom Menu **C1** will be displayed.

**9** Press the **MENU** button repeatedly to exit the menus.

- For information on taking photos in Pro Capture modes, see page 168.



Adjust self-timer settings, including the shutter release delay and the number of shots taken when the timer expires.

- This setting can be accessed via:
  - The button
  - The LV super control panel (P. 158)
  - The menus (P. 159)
  - Live controls (P. 159)

<b>Number of Frames</b>	Choose the number of shots taken when the timer expires.
<b>Timer</b>	Choose how long the camera waits to begin shooting after the shutter button is pressed all the way down.
<b>Interval Length</b>	If the number of shots is 2 or more, choose the interval between the shots taken when the timer expires.
<b>Every Frame AF</b>	If the number of shots is 2 or more, choose whether the camera focuses before each shot.

## ■ Access via the Button

1 Press the button.

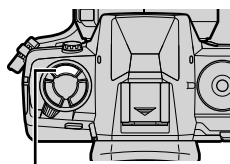

button

- [/] (sequential shooting/self-timer) options will be displayed.



[/] (sequential shooting/self-timer) options

2 Rotate the rear dial to highlight [, , or ].



- 3 Press the **INFO** button to display self-timer options.
  - Choose from [Timer], [Number of Frames], [Interval Length], and [Every Frame AF].
  - Highlight items using the <math>\triangleleft\triangle></math> buttons and use the  $\triangle\triangledown$  buttons to choose an option.
- 4 Press the **OK** button to save the changes and return to the shooting display.
  - You can also choose a setting by holding the  $\text{⚡}\text{⏏}\text{⌚}$  button and rotating the rear dial. Release the button to select the setting and return to the shooting display. In this case, the **INFO** button cannot be used to display self-timer options.

## ■ Access via the LV Super Control Panel

- 1 Highlight [ $\text{⏏}\text{⌚}$ ] (sequential shooting/self-timer) in the LV super control panel and press the **OK** button.

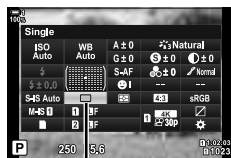

$\text{⏏}\text{⌚}$  (sequential shooting/self-timer)

- 2 Highlight [ $\text{⌚}$ ] using  $\triangleleft\triangle>$  on the arrow pad and press the **INFO** button.
  - Custom timer options will be displayed.



- 3 Highlight items using the  $\triangleleft\triangle>$  buttons and use  $\triangle\triangledown$  to change.
- 4 Press the **INFO** button to save the changes.
- 5 Press the shutter button halfway to return to the shooting display.

## ■ Menu Access

Use [ ]/[ ]/[ ] (drive mode) > [ ]/[ ] (sequential shooting/self-timer) in Shooting Menu 1.



**MENU** button → tab → [ ]/[ ]/[ ] → [ ]/[ ] → [ ] → Press ▷ on the arrow pad to view custom self-timer settings → Use the ▲ ▼ buttons to highlight an item, press the ▷ button, and use the ▲ ▼ buttons to choose an option

## ■ Access via Live Controls

Highlight [ ]/[ ] (sequential shooting/self-timer) in the live controls, highlight [ ] using ◀▶ on the arrow pad, and press the **INFO** button.

- For information on displaying live controls, see “Using Live Controls” (P. 68).



[ ]/[ ] (sequential shooting/self-timer)

2

Reduce the slight blur caused by the motion of the shutter. Pictures are taken using an electronic front-curtain shutter. This option can be used in combination with sequential shooting and self-timer modes.

<b>Off</b>	Disable anti-shock. Anti-shock options will not be listed when you press the  button or highlight the drive mode in the LV super control panel.
<b>0 sec–30 sec</b>	Choose how long the camera waits to take the picture after the shutter button is pressed all the way down. Select [0 sec] for standard electronic front-curtain shutter photography.

- The mechanical shutter is used at shutter speeds faster than 1/320 s.

## Adjusting Anti-Shock Settings

- 1 Press the **MENU** button to display the menus.
- 2 Highlight [Anti-Shock [◆]/Silent [▼]] in Shooting Menu 2 and press on the arrow pad.
- 3 Highlight [Anti-Shock [◆]] using the buttons and press the button.
- 4 Highlight a shutter-release delay ([0 sec]–[30 sec]) using the buttons and press the button.
  - [Anti-Shock [◆]] options will be displayed.

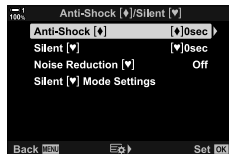

- 5 Highlight the desired shutter-release delay using the  $\Delta$   $\nabla$  buttons and press the **OK** button.

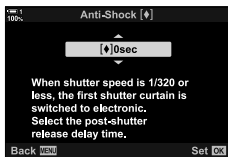

- 6 Press the **OK** button when the desired option is highlighted.
- [Anti-Shock [♦]/Silent [♥]] options will be displayed.
  - To disable anti-shock, highlight [Off] in the [Anti-Shock [♦]/Silent [♥]] display and press the **OK** button.

- 7 Press the **MENU** button repeatedly to exit the menus.
- The anti-shock version of the current drive mode (indicated by a ♦ icon) will be selected.
  - If [High Res Shot] was selected when you entered the menu, ♦ [ ] (single frame anti-shock) will be selected when you exit.
  - If [Pro Capture Low] was selected when you entered the menu, ♦ [ ] (sequential low anti-shock) will be selected when you exit.

- At settings other than [Off], anti-shock options will be listed in the drive-mode menu when you press the [Live View] button or highlight drive mode in the LV super control panel or using live controls.
- You can choose the options available in the drive mode display. [Custom Menu] > [Settings] (P. 520)

## ■ Accessing Anti-Shock Options

When an option other than [Off] is selected for [Anti-Shock [♦]/Silent [♥]] > [Anti-Shock [♦]] in  Shooting Menu 2, you can access anti-shock options using:



### The Button

 button → Rotate the rear dial to select options marked with [♦]

### The LV Super Control Panel







Highlight [] (sequential shooting/self-timer) → Rotate the front dial to select options marked with [♦]

### The Menus



Use [] (drive mode) > [] (sequential shooting/self-timer) in  Shooting Menu 1.



2

**MENU** button →  tab → [] → [] → Press  on the arrow pad to view options → Use the   buttons to select options marked with [♦]

### Live Controls

Highlight [] (sequential shooting/self-timer) in the live controls and use   on the arrow pad to select options marked with [♦].

- For information on displaying live controls, see “Using Live Controls” (P. 68).



 (sequential shooting/self-timer)

Take pictures using the electronic shutter. Use for shutter speeds faster than 1/8000 s or in settings where the sound of the shutter would be unwelcome. The electronic shutter can be used in single-frame mode and self-timer modes and for frame rates as high as 60 fps in sequential shooting modes.

- The flash sync speed is 1/50 s.
- At [📷] ISO settings over ISO 8000, the flash sync speed drops to 1/20 s and the maximum frame advance rate to 30 fps.

<b>Off</b>	Disable silent mode. Silent modes will not be listed when you press the ⚡📷🕒 button or highlight the drive mode in the LV super control panel.
<b>0 sec–30 sec</b>	Choose how long the camera waits to take the picture after the shutter button is pressed all the way down. Select [0 sec] for standard electronic front-curtain shutter photography.

- At settings other than [Off], silent modes will be listed when you press the ⚡📷🕒 button or highlight drive mode in the LV super control panel or using live controls.
- To use the flash in [Silent [♥]] mode, select [Allow] for [Silent [♥] Mode Settings] > [Flash Mode] (P. 167).

- 1 Press the **MENU** button to display the menus.
- 2 Highlight [Anti-Shock [♦]/Silent [♥]] in 📷 Shooting Menu 2 and press ▶ on the arrow pad.

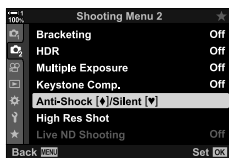

- 3 Highlight [Silent [♥]] using the Δ ▽ buttons and press the ▶ button.

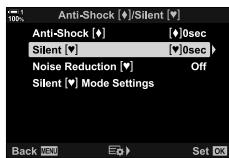

- 4 Highlight a shutter-release delay ([0 sec]–[30 sec]) using the Δ ▽ buttons and press the ▶ button.
  - [Silent [♥]] options will be displayed.

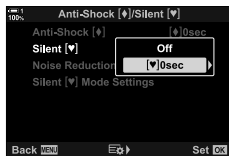

- 5** Highlight the desired shutter-release delay using the  $\Delta$   $\nabla$  buttons and press the **OK** button.



- 6** Press the **OK** button when the desired option is highlighted.
- [Anti-Shock [♦]/Silent [♥]] options will be displayed.
  - To disable anti-shock, highlight [Off] in the [Anti-Shock [♦]/Silent [♥]] display and press the **OK** button.
- 7** Press the **MENU** button repeatedly to exit the menus.
- The silent version of the current drive mode (indicated by a [♥] icon) will be selected.

- You can choose the options available in the drive mode display. Custom Menu **D1** > [/ Settings] (P. 520)



## ■ Accessing Silent-Mode Options

When an option other than [Off] is selected for [Anti-Shock [♦]/Silent [♥]] > [Silent [♥]] in  Shooting Menu 2, you can access silent-mode options using:



### The Button

 button → Rotate the rear dial to select options marked with [♥]







### The LV Super Control Panel

Highlight [/Sequential Shooting icon] (sequential shooting/self-timer) → Rotate the front dial to select options marked with [♥]



### The Menus

Use [/Sequential Shooting icon/Drive Mode icon] (drive mode) > [/Sequential Shooting icon] (sequential shooting/self-timer) in  Shooting Menu 1.



**MENU** button →  tab → [/Sequential Shooting icon/Drive Mode icon] → [/Sequential Shooting icon] → Press  on the arrow pad to view options → Use the   buttons to select options marked with [♥]

### Live Controls

Highlight [/Sequential Shooting icon] (sequential shooting/self-timer) in the live controls and use   on the arrow pad to select options marked with [♥].

- For information on displaying live controls, see “Using Live Controls” (P. 68).



 (sequential shooting/self-timer)

2

## Long Exposure Noise Reduction (Noise Reduction [♥])

Reduce noise in long exposures when shooting in silent mode.

<b>Auto</b>	Reduce noise in long exposures when shooting in silent mode. The sound of the shutter may be audible when noise reduction is active.
<b>Off</b>	Noise reduction off.

- 1 Press the **MENU** button to display the menus.
- 2 Highlight [Anti-Shock [♦]/Silent [♥]] in **Shooting Menu 2** and press **▷** on the arrow pad.

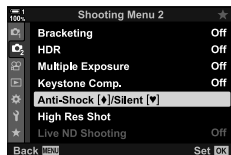

- 3 Highlight [Noise Reduction [♥]] using the **△▽** buttons and press the **▷** button.
  - [Noise Reduction [♥]] options will be displayed.

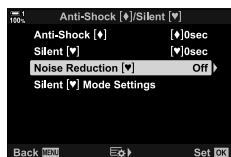

- 4 Highlight an option using the **△▽** buttons and press the **OK** button.
  - [Anti-Shock [♦]/Silent [♥]] options will be displayed.

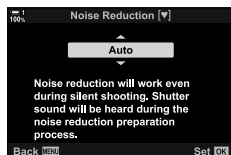

- 5 Press the **MENU** button repeatedly to exit the menus.

## Silent-Mode Options (Silent [♥] Mode Settings)

Choose whether to enable [■)], [AF Illuminator], or [Flash Mode] in silent mode.

Select [Allow] to use current settings for the selected item, [Not Allow] to ignore current settings and disable the selected item.

■))	Choose whether to use the settings currently selected for [■)]) in <b>Custom Menu D4</b> (P. 527).
AF Illuminator	Choose whether to use the settings currently selected for [AF Illuminator] in <b>Custom Menu A3</b> (P. 490).
Flash Mode	Choose whether to use current flash settings (P. 254).

- 1 Press the **MENU** button to display the menus.
- 2 Highlight [Anti-Shock [♦]/Silent [♥]] in **Shooting Menu 2** and press **▶** on the arrow pad.
- 3 Highlight [Silent [♥] Mode Settings] using the **△ ▽** buttons and press the **▶** button.
  - [Silent [♥] Mode Settings] options will be displayed.
- 4 Highlight the desired item using the **△ ▽** buttons and press the **▶** button.
- 5 Highlight [Allow] or [Not Allow] using the **△ ▽** buttons and press the **OK** button.
  - Repeat Steps 4 and 5 as required.
- 6 Press the **MENU** button repeatedly to exit the menus.

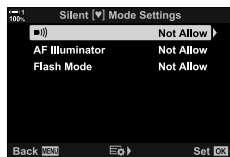
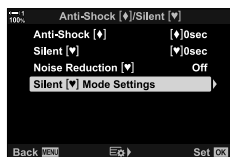
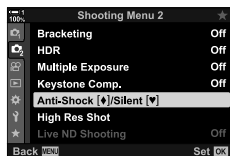

## Reducing Shutter Lag (Pro Capture Photography)





Capture starts when the shutter button is pressed halfway; the moment the button is pressed the rest of the way down, the camera will start saving the last  $n$  captured pictures to the memory card, where  $n$  is a number selected before shooting begins. If the button is held all the way down, shooting will continue until the selected number of pictures is recorded. Use this option to capture moments you might otherwise miss due to your subject's reactions or shutter lag. Choose from [Pro Capture Low] and [Pro Capture High].

### Pro Capture Low (Pro Cap L)

The camera shoots at up to 18 fps. A maximum of 35 frames can be captured before the shutter button is pressed all the way down. If [C-AF], [C-AF MF], [C-AF+TR], or [C-AF+TR MF] is selected for [AF Mode] (P. 115), the camera will focus before each shot. Choose this option if you anticipate that the distance to the subject will change during shooting.

### Pro Capture High (Pro Cap H)

The camera shoots at up to 60 fps. A maximum of 35 frames can be captured before the shutter button is pressed all the way down. The camera will use [S-AF] when [C-AF] or [C-AF+TR] is selected for [AF Mode] (P. 115) and [S-AF MF] when [C-AF MF] or [C-AF+TR MF] is selected. Choose this option if the distance to the subject is unlikely to change very much during shooting.

- Aperture is restricted to values between maximum aperture and f/8.0 while  (Pro Capture Low) mode is in effect.
- Pro Capture is not available while the camera is connected to a smartphone.
- Four Thirds and third-party Micro Four Thirds lenses cannot be used in  (Pro Capture Low) mode.
- The camera will continue to capture pictures for up to a minute while the shutter button is pressed halfway. To resume shooting after capture ends, release the button and then press it halfway once more.
- Photographs may be affected by flicker under fluorescent or other artificial lighting or if the subject moves markedly during shooting.
- During shooting, the display will not go black and the sound of the shutter will not be audible.
- Shutter speeds cannot be slower than a certain value.
- Depending on subject brightness and the options selected for [ISO] and exposure compensation, the display frame rate may drop below that selected for [Frame Rate] (P. 175) in  Custom Menu .

As is the case with other drive modes, Pro Capture modes can be selected using the  button.

1 Press the  button.

- [] (sequential shooting/self-timer) options will be displayed.

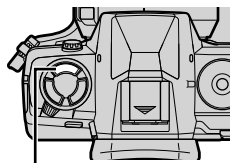

 button







[] (sequential shooting/self-timer) options

2 Rotate the rear dial to highlight **Pro L** (Pro Capture Low) or **Pro H** (Pro Capture High) and press the **OK** button.

- Drive options will clear from the display.
- You can also highlight options by holding the  button and rotating the rear dial.



3 Take pictures.

- Capture starts when the shutter button is pressed halfway. A capture icon () will be displayed. If the button is kept pressed halfway for over a minute, capture will end and the  icon will clear from the display. Press the shutter button halfway again to resume shooting.
  - Press the shutter button all the way down to start saving pictures to the memory card.
  - Shooting will continue while the shutter button is pressed all the way down, up to the number of shots selected for [Frame Count Limiter].
- Pro Capture modes can be selected in much the same way using the LV super control panel or live controls. They can also be selected using [] (P. 154) in  Shooting Menu 1.

Capture icon (green)



## ■ Pro Capture Options

Pro Capture options can be adjusted in **Custom Menu C1**. Use [L Settings] (Pro Capture Low options) to adjust settings for Pro Capture Low and [H Settings] (Pro Capture High options) to adjust settings for Pro Capture High.

<b>Max fps</b>	Choose the frame advance rate. All figures are approximate. <ul style="list-style-type: none"> <li>• Pro Capture Low: 10, 15, or 18 fps</li> <li>• Pro Capture High: 15, 20, 30, or 60 fps</li> </ul>
<b>Pre-shutter Frames</b>	Choose the number of shots captured before the shutter button is pressed all the way down. The maximum is 35.
<b>Frame Count Limiter</b>	Choose the number of shots recorded, including shots captured before recording begins. You can limit the number of shots recorded while the shutter button is pressed all the way down. Select [Off] to continue shooting as long as the shutter button is kept pressed all the way down.

**1** Press the **MENU** button to display the menus.

**2** Display **Custom Menu C1** (Release/Image Stabilizer).



**3** Highlight the desired item using  $\Delta$   $\nabla$  on the arrow pad and press the  $\triangleright$  button.

- Select [L Settings] to adjust settings for Pro Capture Low, [H Settings] to adjust settings for Pro Capture High.



**4** Highlight [Pro Cap] using the  $\Delta$   $\nabla$  buttons and press the  $\triangleright$  button.



**5** Choose a setting for [Max fps].

- Highlight [Max fps] using the  $\Delta$   $\nabla$  buttons and press the  $\triangleright$  button.
- Highlight an option using the  $\Delta$   $\nabla$  buttons and press the **OK** button.

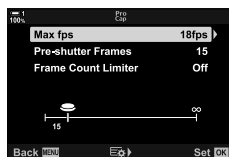

- 6** Choose a setting for [Pre-shutter Frames].
- Highlight [Pre-shutter Frames] using the  $\Delta$   $\nabla$  buttons and press the  $\triangleright$  button.
  - Highlight an option using the  $\Delta$   $\nabla$  buttons and press the **OK** button.
  - To disable pre-capture, select [0].

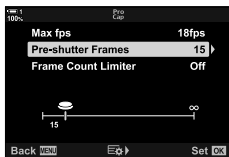

- 7** Choose the maximum number of shots per burst ([Frame Count Limiter]).
- Highlight [Frame Count Limiter] using the  $\Delta$   $\nabla$  buttons and press the  $\triangleright$  button.
  - To keep shooting as long as the shutter release button is pressed all the way down, select [Off].
  - To choose a maximum number of shots, highlight the current setting and press the  $\triangleright$  button to display options. Highlight digits using the  $\triangleleft$   $\triangleright$  buttons and use the  $\Delta$   $\nabla$  buttons to change.
  - The maximum number of shots per burst includes shots captured while the shutter button is pressed halfway.
  - Press the **OK** button to save changes to settings.

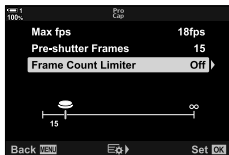

- 8** Press the **OK** button.
- $\star$  Custom Menu **C1** will be displayed.
- 9** Press the **MENU** button repeatedly to exit the menus.









# Interval-Timer Photography

## (Intrvl. Sh./Time Lapse)

Take a series of photos automatically at a preset interval. You also have the option of saving the series as a time-lapse movie.

- Interval-timer photography is available in modes **P**, **A**, **S**, and **M**.
- Bracketing, HDR bracketing, multiple exposure, and live ND filter features cannot be used.
- You can use the wireless release option for connected smartphones.

<b>Number of Frames</b>	Choose the number of shots.
<b>Start Waiting Time</b>	Choose how long the camera waits before starting interval timer photography and taking the first shot.
<b>Interval Length</b>	Choose how long the camera waits between shots once shooting has begun.
<b>Time Lapse Movie</b>	Choose whether to record a time-lapse movie. [Off]: The camera saves the individual shots but does not use them to create a time-lapse movie. [On]: The camera records the individual shots and also uses them to create a time-lapse movie.
<b>Movie Settings</b>	Choose the frame size ([Movie Resolution]) and frame rate ([Frame Rate]) for movies created using [Time Lapse Movie].

- 1 Press the **MENU** button to display the menus.
- 2 Highlight [//] in  Shooting Menu 1 and press  on the arrow pad.
- 3 Highlight [Intrvl. Sh./Time Lapse] using the   buttons and press the  button.

- [Intrvl. Sh./Time Lapse] options will be displayed.





- 4 Highlight [On] using the  $\Delta$   $\nabla$  buttons and press the  $\triangleright$  button.



- 5 Highlight items using the  $\Delta$   $\nabla$  buttons.
- Press the  $\triangleright$  button to display options for the highlighted item.
  - Press the **OK** button when settings are complete.



- 6 Press the **OK** button repeatedly to return to **Shooting Menu 1**.
- Press the **MENU** button to exit the menus.
  - A  icon will appear in the shooting display (the icon shows the selected number of shots).

Interval-timer photography

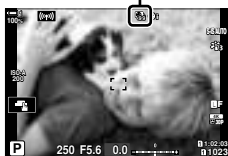

2

- 7 Press the shutter button to start shooting.
- The  icon will turn green and the number of shots remaining will be displayed.
  - To end shooting before all shots are taken, press the **MENU** button.
  - Pictures will be taken even if the autofocus operation fails. Use manual focus to focus at a fixed distance.
- Each picture will be displayed for 0.5 seconds after it is taken ([Rec View], P. 90).
  - If the option selected for [Start Waiting Time] or [Interval Length] is longer than 1 minute 30 seconds, the monitor will go dark and the camera will turn off after one minute. The camera and monitor will turn on automatically 10 seconds before the next shot. They can also be turned on by pressing the shutter button halfway.
  - The camera uses [S-AF] when [C-AF] or [C-AF+TR] is selected for [AF Mode] and [S-AF MF] when [C-AF MF] or [C-AF+TR MF] is selected.
  - Touch controls are disabled during interval-timer photography.
  - The flash will not fire if the time needed for it to charge is longer than the interval.
  - A time-lapse movie will not be created if any of the photos fail to record correctly.
  - A time-lapse movie will not be created if the space on the memory card is insufficient.
  - Performing any of the following operations after shooting has started cancels interval-timer photography: rotating the mode dial, pressing the **MENU**,  $\triangleright$ , or lens-release button, or connecting a USB cable.
  - Turning the camera off ends interval-timer photography.
  - Interval-timer photography will end if the battery runs low. Be sure the battery is charged before shooting.

# Burst Mode Image Stabilization



## ( Image Stabilization)

Choose the type of image stabilization applied during burst shooting.

To maximize the effects of image stabilization during burst shooting, the camera centers the image sensor for every shot. This slightly reduces the frame advance rate.

<b>IS Priority</b>	Priority is given to image stabilization. The frame advance rate drops slightly.
<b>Fps Priority</b>	Priority is given to the frame advance rate. Image stabilization may be slightly less effective under some conditions.

**1** Press the **MENU** button to display the menus.

**2** Display  Custom Menu  (Release//Image Stabilizer).

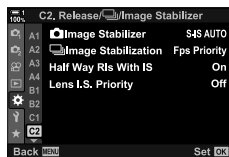



**3** Highlight [ Image Stabilization] using  $\Delta$   $\nabla$  on the arrow pad and press the  $\triangleright$  button.



**4** Highlight an option using the  $\Delta$   $\nabla$  buttons.

**5** Press the **OK** button to select the highlighted option.

**6** Press the **MENU** button repeatedly to exit the menus.

- You can also exit the menus by pressing the shutter button halfway.
- [ Image Stabilization] is fixed at [Fps Priority] in  (Pro Capture Low) and  (Pro Capture High) modes.

Increase the viewfinder display rate to smooth subject motion. This eases the task of tracking fast-moving and otherwise hard-to-frame subjects.

<b>Normal</b>	The normal display rate. Select this option in most circumstances.
<b>High</b>	Smooths motion even when the subject is moving quickly. Fast-moving subjects are easier to track. [Normal] will be selected automatically if the camera's internal temperature rises during shooting.

**1** Press the **MENU** button to display the menus.

**2** Display **Custom Menu D2 (Disp/■)/PC**.

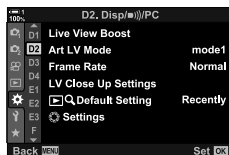

**3** Highlight [Frame Rate] using  $\Delta$ / $\nabla$  on the arrow pad and press the  $\blacktriangleright$  button.

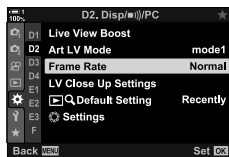

**4** Highlight an option using the  $\Delta$ / $\nabla$  buttons.

**5** Press the **OK** button to select the highlighted option.

**6** Press the **MENU** button repeatedly to exit the menus.

- You can also exit the menus by pressing the shutter button halfway.

## 2-11 Image Stabilization

Image stabilization reduces blur caused by the camera moving while the shutter is open.

The camera is equipped with 5-axis image stabilization that in addition to reducing blur caused by motion on the pitch and yaw axes, can be used with all lenses to reduce blur caused by motion on the horizontal, vertical, and roll axes. Not only can it be used at night, in darkened interiors, with telephoto lenses, and in other situations in which blur due to camera motion is likely to occur, it can also be used to reduce blur during macro photography. You will need to provide the lens focal length when using image stabilization with lenses that are not part of the Four Thirds or Micro Four Thirds family.



### Reducing Camera Blur

### Image Stabilizer

2



Reduce blur caused by the camera shake that commonly occurs, for example, when the subject is poorly lit or in photos taken at high zoom ratios.

- This setting can be accessed via:
  - The LV super control panel (P. 177)
  - Live controls (P. 177)
  - The menus (P. 177)

<b>S-IS Off</b>	Image stabilization disabled. Select this option when using a tripod.
<b>S-IS AUTO</b> (auto)	Image stabilization applies to motion on all axes. If panning motion is detected, the camera will automatically suspend image stabilization on that axis.
<b>S-IS</b>  (multi-directional)	Image stabilization applies to motion on all axes.
<b>S-IS</b>  (vertical)	Image stabilization applies to vertical motion. Use when panning the camera horizontally.
<b>S-IS</b>  (horizontal)	Image stabilization applies to horizontal motion. Use when panning the camera vertically.

- Image stabilization may be unable to compensate for excessive camera motion or very slow shutter speeds. Use a tripod in these cases.
- You may notice noise or vibration while image stabilization is in effect.
- The setting selected with the lens image stabilization switch, if any, takes priority over that selected with the camera.
- [S-IS AUTO] functions as [S-IS ] when [On] is selected for [Lens I.S. Priority].



- You can choose whether image stabilization will be performed while the shutter button is pressed halfway.  [Half Way RIs With IS] (P. 178)
- You can prioritize lens image stabilization.  [Lens I.S. Priority] (P. 512)

## ■ Access via the LV Super Control Panel

- 1 Highlight [📷 Image Stabilizer] in the LV super control panel.

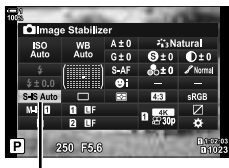

📷 image stabilization

- 2 Highlight an option using the front dial.
- 3 Press the shutter button halfway to select the highlighted option and exit the LV super control panel.

## ■ Menu Access

Use [📷 Image Stabilizer] in **⚙ Custom Menu** [C2] (Release/📷/Image Stabilizer).

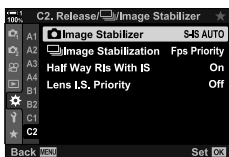

**MENU** button ➔ **⚙** tab ➔ **C2** tab ➔ [📷 Image Stabilizer] ➔ Press **▷** on the arrow pad to view options ➔ Use the **△▽** buttons to choose an option

## ■ Access via Live Controls

Highlight [📷 Image Stabilizer] in the live controls and select an option using **<▷** on the arrow pad.

- For information on displaying live controls, see “Using Live Controls” (P. 68).



📷 image stabilization

## 📷 Non-Four Thirds/Micro Four Thirds Lenses

When using lenses other than Micro Four Thirds or Four Thirds system lenses, you will need to specify the lens focal length. Press the **INFO** button in the menu where you select an option, then use the **△▽<▷** buttons to highlight a value and press the **OK** button. If the lens information saved with [Lens Info Settings] (P. 550) is used, the saved focal length will be applied.

- Choose from values of from 0.1 mm to 1000.0 mm.
- Use the value printed on the lens.
- The selected value is not reset when you select [Reset / Custom Modes] (P. 91) > [Reset] (basic) in **📷 Shooting Menu 1**.

# Half-Press Image Stabilization

## (Half Way RIs With IS)

Choose whether image stabilization applies while the shutter button is pressed halfway. An example of a situation in which you might want to suspend image stabilization would be when using the level gauge to keep the camera level while framing photographs.

<b>On</b>	Image stabilization is performed while the shutter button is pressed halfway.
<b>Off</b>	Image stabilization is not performed while the shutter button is pressed halfway.

- 1 Press the **MENU** button to display the menus.
- 2 Display **Image Stabilizer** Custom Menu **C2** (Release//Image Stabilizer).
- 3 Highlight [Half Way RIs With IS] using  $\Delta$ / $\nabla$  on the arrow pad and press the  $\triangleright$  button.

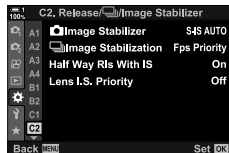

- 4 Highlight [On] or [Off] using the  $\Delta$ / $\nabla$  buttons and press the **OK** button.
- 5 Press the **MENU** button repeatedly to exit the menus.





## 2-12 Metering and Exposure



The camera meters subject brightness and adjusts exposure accordingly. The camera can be configured to raise ISO sensitivity automatically when lighting is poor. You can also reduce flicker when shooting under artificial light.

## Adjusting Exposure (Exposure Compensation)



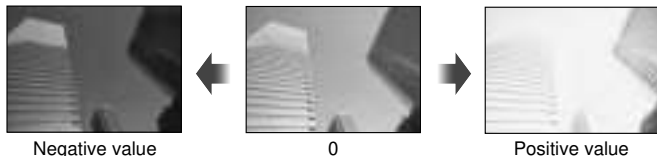

The exposure selected automatically by the camera can be altered to suit your artistic intent. Choose positive values to make pictures brighter, negative values to make them darker. Exposure compensation can be adjusted by up to  $\pm 5.0$  EV.

- This setting can be accessed via:
  - The  button
  - The dials
- Exposure compensation is available in modes **P**, **A**, and **S**. To enable exposure compensation in mode **M**, select [AUTO] for  ISO (P. 181).



- Exposure compensation can be adjusted by up to  $\pm 5.0$  EV. The exposure bar in the display shows values of up to  $\pm 3$  EV. The bar flashes when a value outside this range is selected.
- The viewfinder and live view show the effects of values not exceeding  $\pm 3.0$  EV.
- To view the effects of exposure compensation in live view, select [Off] for [Live View Boost] in  Custom Menu  (P. 200). [Live View Boost] is [Off] by default.

### ■ Access via the (Exposure Compensation) Button



Hold the  button and rotate the front or rear dial. You can also hold the  button and use the   buttons on the arrow pad.



Exposure      Exposure  
compensation      bar

- To reset exposure compensation, press and hold the **OK** button.



-  (exposure compensation) can be assigned to other controls. Use  Button Function] (P. 463) in  Custom Menu .

### ■ Access via the Dials

In modes **P**, **A**, and **S**, exposure compensation can be adjusted using the front dial. Rotate the dial left or right. In mode **M**, hold the  button and rotate the front or rear dial.



Select a value according to subject brightness. Higher values let you photograph darker scenes but also increase image “noise” (mottling). Select [AUTO] to let the camera adjust sensitivity according to lighting conditions.

- This setting can be accessed via:
  - The **ISO** button
  - The LV super control panel (P. 182)
  - Live controls (P. 182)

<b>AUTO</b>	Sensitivity is adjusted automatically according to shooting conditions. Use [ ISO-Auto Set] (P. 183) in  Custom Menu  to choose the maximum sensitivity selected by the camera and the shutter speed at which auto sensitivity control takes effect.
<b>L64, L100, 200–25600</b>	Choose a value for ISO sensitivity. ISO 200 offers a good balance between noise and dynamic range. Choose [L100] or [L64] for larger apertures (higher f-numbers) or slower shutter speeds. [L64] is equivalent to ISO 64, [L100] to ISO 100. <ul style="list-style-type: none"> <li>• [L64] and [L100] are available at all exposure step values.</li> <li>• [L64] and [L100] reduce dynamic range.</li> </ul>

2

- Combining values over ISO 8000 with settings that use an electronic shutter (for example, silent mode or focus bracketing) sets the flash sync speed to 1/20 s.
- Regardless of the value selected for ISO sensitivity, the flash sync speed for photos taken using ISO bracketing in silent mode is 1/20 s.

## ■ Access via the ISO Button

1 Press the **ISO** button.

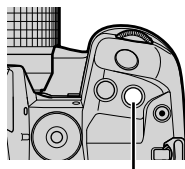

ISO button

- [ ISO] options will be displayed.

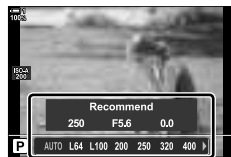

[ ISO] options

- 2 Rotate the front or rear dial to highlight an option.
  - You can also rotate the front or rear dial while pressing the ISO button.

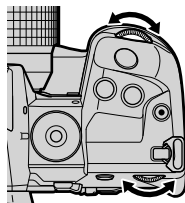

- 3 Press the shutter button halfway to select the highlighted option and exit.



- ISO sensitivity selection can be assigned to other controls. Use [ Button Function ] (P. 463) in Custom Menu .

## ■ Access via the LV Super Control Panel

- 1 Display the LV super control panel and highlight [ ISO ].



ISO

- 2 Highlight an option using the front dial.
- 3 Press the shutter button halfway to select the highlighted option and exit the LV super control panel.

## ■ Access via Live Controls

Highlight [ ISO ] in the live controls and select an option using on the arrow pad.

- For information on displaying live controls, see “Using Live Controls” (P. 68).

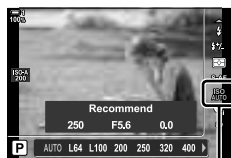

ISO

## Options for [📷 ISO] > [AUTO] (📷 ISO-Auto Set)

Choose how the camera adjusts settings when [AUTO] is selected for [📷 ISO].

<b>Upper Limit / Default</b>	[High Limit]: Choose the maximum sensitivity selected automatically by the camera. [Default]: Choose the default sensitivity. <ul style="list-style-type: none"><li>The maximum is 6400. Sensitivity may drop below the default value if optimal exposure cannot be achieved at the current aperture and shutter speed.</li></ul>
<b>Lowest S/S Setting</b>	Choose the shutter speed at which the camera will start to raise ISO sensitivity when [AUTO] is selected for [📷 ISO]. This option takes effect in modes <b>P</b> and <b>A</b> . Select [Auto] to let the camera choose the minimum shutter speed automatically.

- The maximum ISO sensitivity automatically changes:
  - to ISO 800 when the live ND filter is enabled,
  - to ISO 1600 when [Shooting Method] > [Tripod] is selected for High Res Shot, and
  - to ISO 1600 when [Dramatic Tone] or [Watercolor] is selected for picture mode.

- Press the **MENU** button to display the menus.
- Display **⚙ Custom Menu E1 (Exp/ISO/BULB/📷)**.



- Highlight [📷 ISO-Auto Set] using **△ ▽** on the arrow pad and press the **▶** button.

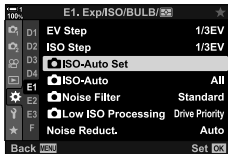

- 4** Highlight an item using the  $\Delta$   $\nabla$  buttons and press the  $\triangleright$  button.

[Upper Limit / Default]: Highlight an option using the  $\triangleleft$   $\triangleright$  buttons and use the  $\Delta$   $\nabla$  buttons to change. Press the **OK** button to return to the [📷 ISO-Auto Set] menu.

[Lowest S/S Setting]: Choose [Auto] or select a shutter speed. To choose a new value, highlight the current setting using the  $\Delta$   $\nabla$  buttons and press the  $\triangleright$  button, then highlight the desired option using the  $\Delta$   $\nabla$  buttons and press the **OK** button. Press the **OK** button again to return to the [📷 ISO-Auto Set] menu.

- 5** Press the **MENU** button repeatedly to exit the menus.

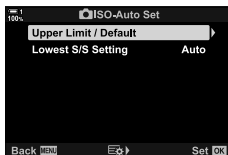

## Shooting Mode and [CAMERA ISO] > [AUTO]

### (CAMERA ISO-Auto)

Choose the shooting modes in which auto ISO sensitivity control ([CAMERA ISO] > [AUTO]) is available.

<b>P/A/S</b>	Auto ISO sensitivity control is available when [AUTO] is selected for [CAMERA ISO] in modes <b>P</b> , <b>A</b> , and <b>S</b> .
<b>All</b>	Auto ISO sensitivity control is available when [AUTO] is selected for [CAMERA ISO] in modes <b>P</b> , <b>A</b> , <b>S</b> , and <b>M</b> .

- 1 Press the **MENU** button to display the menus.
- 2 Display **⚙ Custom Menu E1 (Exp/ISO/BULB/⏏)**.

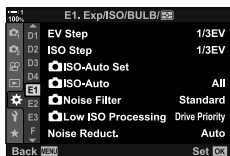

- 3 Highlight [CAMERA ISO-Auto] using **Δ**/**∇** on the arrow pad and press the **▶** button.



- 4 Highlight an option using the **Δ**/**∇** buttons and press the **OK** button.











- 5 Press the **MENU** button repeatedly to exit the menus.

2

Choose the method used to measure subject brightness.

- This setting can be accessed via:
  - The **AF** button
  - The menus (P. 187)
  - The LV super control panel (P. 187)
  - Live controls (P. 187)

 (digital ESP metering)	Suited to most scenes, including back-lit subjects. The camera meters 324 areas of the frame and calculates optimal exposure taking into consideration the nature of the scene.	
 (center-weighted averaging)	Suited to compositions that place the main subject at the center of the frame. The camera sets exposure based on the average light level for the entire frame while assigning the greatest weight to the area in the center.	
 (spot metering)*	Use a specific area of the subject meter exposure. The camera meters a small portion (approximately 2%) of the frame.	
 (spot highlight metering)*	Brightens the spot metering area, brightening highlights.	
 (spot shadow metering)*	Darkens the spot metering area, darkening shadows.	

\* The camera can be configured to meter the current AF target.  **[[:]] Spot Metering** (P. 537)

## ■ Access via the AF Button

**1** Press the **AF**  button.

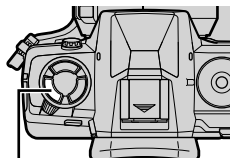

**AF**  button

- [Metering] options will be displayed.

[Metering] options



- 2** Rotate the front dial to highlight an option.
- You can also rotate the front or rear dial while pressing the **AF**  button.

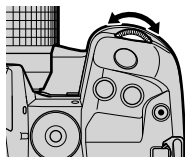

- 3** Press the shutter button halfway to select the highlighted option and exit.

## ■ Access via the LV Super Control Panel

- 1** Highlight [Metering] in the LV super control panel.

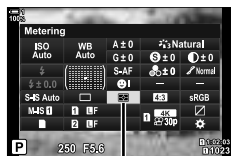





Metering



2

- 2** Highlight an option using the front dial.
- 3** Press the shutter button halfway to select the highlighted option and exit the LV super control panel.

## ■ Menu Access



Use [Metering] in  Custom Menu .

**MENU** button   Custom Menu   tab  [Metering]

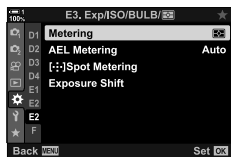
 Use   on the arrow pad to choose an option



## ■ Access via Live Controls

Highlight [Metering] in the live controls and select an option using   on the arrow pad.

- For information on displaying live controls, see “Using Live Controls” (P. 68).



Metering

Lock exposure at the metered value. Use when you want to meter one subject while focusing on another or take several shots at the same exposure.

Exposure lock is performed using a button. Exposure lock is available only when [mode1] or [mode2] is selected for [AEL/AFL] (P. 141). If the **AEL/AFL** button is assigned a role other than exposure lock, you will also need to assign [AEL/AFL] to a control using [Button Function] (P. 463).

## ■ Choosing the AEL/AFL Button Mode

1 Press the **MENU** button to display the menus.

2 Select Custom Menu **A1** (AF/MF).

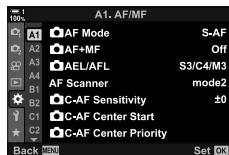

3 Highlight [AEL/AFL] using  $\Delta$   $\nabla$  on the arrow pad and press the  $\blacktriangleright$  button.

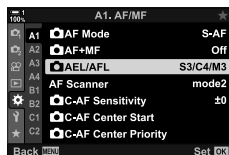

4 Highlight a focus mode using the  $\Delta$   $\nabla$  buttons and press the  $\blacktriangleright$  button.



5 Highlight [mode1] or [mode2] using the  $\Delta$   $\nabla$  buttons and press the **OK** button.



6 Press the **MENU** button repeatedly to exit the menus.



## ■ Using the AEL/AFL Button

- 1 Compose the shot to meter the subject for which you want to set exposure and press the **AEL/AFL** button once.

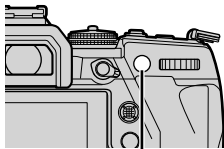

AEL/AFL button

- Exposure will lock and an **AEL** icon will appear in the display.



AEL icon

- 2 To end exposure lock, press the **AEL/AFL** button again.
  - The **AEL** icon will clear from the display.

  - Operating the mode dial or the **MENU** or **OK** buttons also ends exposure lock.

2

When shooting under fluorescent or other artificial workplace or outdoor lighting, you may notice flicker in the live view display or uneven exposure in photos taken at fast shutter speeds. This item reduces these effects.

## Reducing Flicker in Live View (Anti-Flicker LV)

Reduce flicker under fluorescent lighting and the like. Choose this option if flicker makes the display difficult to view.

<b>Auto</b>	The camera detects and reduces flicker.
<b>50Hz</b>	Reduce flicker under workplace or outdoor lighting powered by alternating current with a frequency of 50 Hz.
<b>60Hz</b>	Reduce flicker under workplace or outdoor lighting powered by alternating current with a frequency of 60 Hz.
<b>Off</b>	Flicker reduction off.

**1** Press the **MENU** button to display the menus.

**2** Display **⚙ Custom Menu** **C1** (Release//Image Stabilizer).



**3** Highlight [Flicker reduction] using  $\Delta$   $\nabla$  on the arrow pad and press the  $\triangleright$  button.

- [Flicker reduction] options will be displayed.



**4** Highlight [Anti-Flicker LV] using the  $\Delta$   $\nabla$  buttons and press the  $\triangleright$  button.

- [Anti-Flicker LV] options will be displayed.

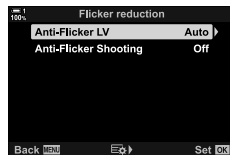

- Highlight an option using the  $\Delta$   $\nabla$  buttons and press the **OK** button.
  - [Flicker reduction] options will be displayed.



- Press the **MENU** button repeatedly to exit the menus.

## Reducing Flicker in Photographs (Anti-Flicker Shooting)

You may notice uneven exposure in photos taken under flickering light. When this option is enabled, the camera will detect the flicker frequency and adjust the timing of the shutter release accordingly. This feature applies to photos taken with the mechanical shutter.

- Press the **MENU** button to display the menus.
- Display  $\star$  Custom Menu **C1** (Release/Image Stabilizer).



- Highlight [Flicker reduction] using  $\Delta$   $\nabla$  on the arrow pad and press the  $\triangleright$  button.
  - [Flicker reduction] options will be displayed.

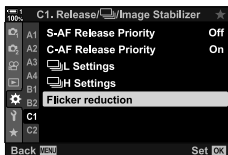

- Highlight [Anti-Flicker Shooting] using the  $\Delta$   $\nabla$  buttons and press the  $\triangleright$  button.
  - [Anti-Flicker Shooting] options will be displayed.

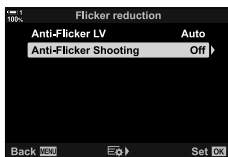

**5** Highlight [On] or [Off] using the  $\Delta$   $\nabla$  buttons and press the **OK** button.

- [Flicker reduction] options will be displayed.

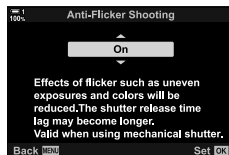

**6** Press the **MENU** button repeatedly to exit the menu.

- A **FLK** icon appears in the display when [On] is selected.



2

- This option does not take effect in modes that use the electronic shutter, including silent modes, High Res Shot, and Pro Capture modes.
- The camera may be unable to detect flicker at some settings. Normal release timing will be used if flicker is not detected.
- Normal release timing is used at slow shutter speeds.
- Enabling flicker reduction may cause release lag, slowing the frame advance rate during burst photography.

# Reducing Flicker Under LED Lighting

## (📷 Flicker Scan)

Banding may occur in photographs taken under LED lighting. Use [📷 Flicker Scan] to optimize shutter speed while viewing banding in the display.

This item can be used in **S**, **M**, and silent mode and with High Res Shot and Pro Capture shooting.

- The range of available shutter speeds is reduced.

- 1 Choose shooting and drive modes.
  - Choose shooting mode **S** or **M**.
  - Choose one of the following drive modes:
    - Silent mode (📷, 📷L, 📷H, 📷2s, 📷2s, or 📷C)
    - High Res Shot (📷)
    - Pro Capture (📷L or 📷H)

- 2 Press the **MENU** button to display the menus.

- 3 Display ⚙️ Custom Menu **E2** (Exp/ISO/BULB/📷).



- 4 Highlight [📷 Flicker Scan] using  $\Delta$ / $\nabla$  on the arrow pad and press the  $\triangleright$  button.

- [📷 Flicker Scan] options will be displayed.



- 5 Highlight [On] using the  $\Delta$ / $\nabla$  buttons and press the **OK** button.

- The camera will return to the previous menu.

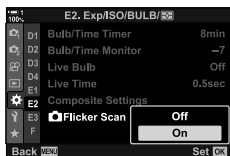

- 6** Press the **MENU** button repeatedly to exit the menus.
- The camera will exit to the shooting display. A **Flicker Scan** icon will be displayed.



Flicker Scan icon

- 7** Choose a shutter speed while viewing the display.
- Choose a shutter speed using the front or rear dial or the  $\Delta$   $\nabla$  buttons.
  - Continue adjusting shutter speed until banding is no longer visible in the display.
  - Press the **INFO** button; the display will change and the **Flicker Scan** icon will no longer be displayed. You can adjust aperture and exposure compensation. Do so using the front or rear dial or the arrow pad.
  - Press the **INFO** button repeatedly to return to the flicker scan display.

- 2** **8** Take pictures once settings have been adjusted to your satisfaction.

- Focus peaking, the LV super control panel, and live controls are not available in the flicker scan display. To view these items, first press the **INFO** button to exit the flicker scan display.



- [**📷** Flicker Scan] can be assigned to a button. You then need only press the button to enable flicker scan. **👉** **⚙️** Custom Menu **B1** > [**📷** Button Function] (P. 463)

The camera varies exposure over a series of shots, selects from each tone range with the highest level of detail, and combines them to create a single picture with a wide dynamic range. If the photo features a high-contrast subject, details that would otherwise be lost in shadows or highlights will be preserved.

- This option is available in **P**, **A**, **S**, and **M** modes.

<b>HDR1</b>	Each time you take a photo, the camera will take a series of shots while varying exposure and combine them into a single picture. Choose [HDR1] for natural-looking results, [HDR2] for a more painterly effect. <ul style="list-style-type: none"> <li>[ ISO] is fixed at ISO 200.</li> </ul>
<b>HDR2</b>	<ul style="list-style-type: none"> <li>Shutter speeds can be as slow as 4 s. Shooting will continue for up to 15 s.</li> <li>Picture mode is fixed at [Natural] and color space at [sRGB].</li> <li>The combined picture is saved in JPEG format. If [RAW] is selected for image quality, it will instead be recorded in RAW + JPEG format.</li> </ul>
<b>3f 2.0EV</b>	Each time you take a photo, the camera will vary exposure over a series of shots. The shots are not combined to create a single picture. The shots can however be combined using HDR software on a computer or other device.
<b>5f 2.0EV</b>	
<b>3f 3.0EV</b>	
<b>5f 3.0EV</b>	
<b>7f 2.0EV</b>	

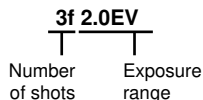

2

- Press the **MENU** button to display the menus.
- Highlight [HDR] in Shooting Menu 2 and press on the arrow pad.

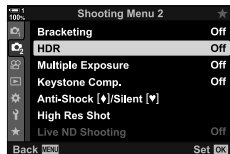

- Highlight an option using the buttons and press the **OK** button.
  - Shooting Menu 2 will be displayed.

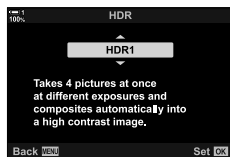

#### 4 Press the **MENU** button repeatedly to exit the menus.

- The camera will return to the shooting display. An **[HDR]** icon will be displayed.
- The drive mode will be fixed at  (sequential high).





#### 5 Take pictures.

- Each time you press the shutter button, the camera will take the selected number of shots.
- In [HDR1] and [HDR2] modes, the camera will automatically combine the shots into a single picture.
- Exposure compensation is available in modes **P**, **A**, and **S**.
- In mode **M**, the camera takes the values selected for aperture and shutter speed as a base for HDR photography.

- Use a tripod or take similar measures to fix the camera in place.
- The image displayed in the monitor or viewfinder during shooting differs from the final HDR picture.
- Noise may appear in the final picture when a slower shutter speed is selected in [HDR1] or [HDR2] mode.
- The following cannot be used:  
flash photography, bracketing, multiple exposure, interval-timer photography, keystone compensation, live ND photography, and fisheye correction.



- [HDR] can be assigned to a button. You then need only press the button to enable HDR.  
  Custom Menu **B1** >  Button Function] (P. 463)



# Slowing the Shutter in Bright Light (Live ND Shooting)

The camera makes a series of exposures and combines to create a single photo that appears to have been taken at a slow shutter speed.

- This option is available in modes **S** and **M**.

<b>ND Number</b>	Choose an ND filter type; the camera will convert it to an exposure value and reduce exposure by that amount. Options are available in increments of -1 EV: [ND2 (1EV)], [ND4 (2EV)], [ND8 (3EV)], [ND16 (4EV)], [ND32 (5EV)]
<b>LV Simulation</b>	Choose whether to preview the effect of the selected filter at the current shutter speed. [On]: The effects of shutter speed are shown in the display. [Off]: Use the standard shooting display.

- Changing exposure compensation or shutter speed resets the [LV Simulation] display.

**1** Rotate the mode dial to **S** or **M**.

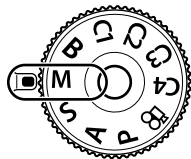

**2**

**2** Press the **MENU** button to display the menus.

**3** Highlight [Live ND Shooting] in **Shooting Menu 2** and press **▶** on the arrow pad.



**4** Highlight [On] using the **Δ**/**▽** buttons and press the **▶** button.

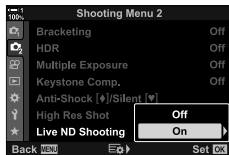

- 5** Choose an option for [ND Number].
- Highlight [ND Number] using the  $\Delta$   $\nabla$  buttons and press the  $\triangleright$  button to view [ND Number] options.
  - Highlight the desired option using the  $\Delta$   $\nabla$  buttons and press the **OK** button to select the highlighted option.



- 6** Choose an option for [LV Simulation].
- Highlight [LV Simulation] using the  $\Delta$   $\nabla$  buttons and press the  $\triangleright$  button to view [LV Simulation] options.
  - Highlight the desired option using the  $\Delta$   $\nabla$  buttons and press the **OK** button to select the highlighted option.



- 7** Press the **OK** button to save the changes to [ND Number] and [LV Simulation].

- 8** To take pictures using the live ND filter, highlight [On] and press the **OK** button, or select [Off] to proceed without enabling the live ND filter.
- $\square$  Shooting Menu 2 will be displayed.



- 9** Press the **MENU** button to exit the menus.
- If you selected [On] for [Live ND Shooting], live ND filter photography will now start.
  - An icon appears in the display when the live ND filter is enabled.
  - To end live ND filter photography, select [Off] in the [Live ND Shooting] display shown in Step 4.



## 10 Adjust shutter speed while previewing the results in the display.

- Adjust shutter speed using the front or rear dial.
- The slowest shutter speed available varies with the ND filter selected.

[ND2 (-1EV)]: 1/30 s

[ND4 (-2EV)]: 1/15 s

[ND8 (-3EV)]: 1/8 s

[ND16 (-4EV)]: 1/4 s

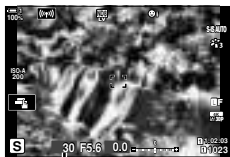

[ND32 (-5EV)]: 1/2 s

- If [On] is selected for [LV Simulation], the effects of changes to shutter speed can be previewed in the display.





Shutter speed

## 11 Take pictures.

- The camera requires a length of time equivalent to the selected shutter speed to produce [LV Simulation] results similar to the final image.
- The upper limit for [ISO] during live ND photography is ISO 800. This also applies when [ISO Auto] is selected.
- Enabling the live ND filter sets the drive mode to .
- The following cannot be used:  
HDR, High Res Shot, multiple exposure, keystone compensation, bracketing, interval-timer photography,  flicker scan, flickerless photography,  subject tracking, and fisheye correction.
- Unlike physical ND filters, the live ND filter does not reduce the amount of light reaching the image sensor, and consequently very bright subjects may be overexposed.



- [Live ND Shooting] can be assigned to a button. You then need only press the button to enable the live ND filter.  Custom Menu **B1** > [ Button Function] (P. 463)

## Live View Exposure Preview (Live View Boost)

Exposure settings such as exposure compensation can be previewed during live view. Alternatively, you can adjust brightness for ease of viewing under night skies and in other dark environments. Settings can be adjusted separately for mode **M**, long exposures, live composite photography, and the like.

<b>Off</b>	Preview exposure in live view. Exposure can be previewed before shooting. <ul style="list-style-type: none"><li>This option does not apply during bulb or time photography.</li></ul>
<b>On1</b>	Exposure preview disabled; brightness is adjusted for ease of viewing. The brightness of the preview differs from the final photograph.
<b>On2</b>	As for [On1] but brighter. Choose when framing shots of the night sky or the like. <ul style="list-style-type: none"><li>The brightness of the preview differs from the final photograph. Subject motion may also appear slightly jerky.</li><li>You can prioritize either the display rate or image quality according to the type of subject.</li></ul>

- The frame advance rate may slow when [On1] or [On2] is selected. Select [Off] to maintain a consistent frame rate.

2

1 Press the **MENU** button to display the menus.

2 Display  Custom Menu **D2** (Disp/■)/PC).



3 Highlight [Live View Boost] using  $\Delta$   $\nabla$  on the arrow pad and press the  $\triangleright$  button.

- [Live View Boost] options will be displayed.

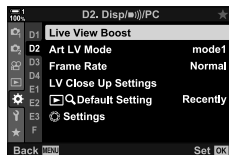

4 Highlight the desired mode using the  $\Delta$   $\nabla$  buttons and press the **OK** button.

[Manual Shooting]: Mode **M**

[Bulb/Time]: Bulb/time

[Live Composite]: Live composite

[Others]: All other modes

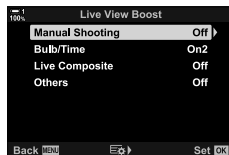

- 5** Highlight an option using the  $\Delta$   $\nabla$  buttons and press the **OK** button.
- [Off] is not available when [Bulb/Time] is selected.
  - If you press the  $\triangleright$  button when [On2] is highlighted, you will be prompted to choose whether to give priority to display frame rate or display quality. Highlight [Frame Rate Priority] or [Quality Priority] and press the **OK** button.
  - Repeat Steps 4 and 5 as required.

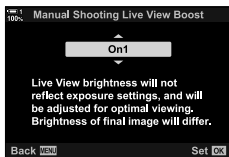

- 6** Press the **MENU** button repeatedly to exit the menus.
- If [Quality Priority] is selected for [On2], the display frame rate will drop when lighting is poor. If [Frame Rate Priority] is selected, colors may be slightly off or display quality may drop.

## 2-13 Color and Quality

This section is primarily devoted to features that affect the color and final look of photographs. Covered are white balance, picture mode, and other items that affect color balance and features (such as High Res Shot) for shooting high-resolution pictures.

### Adjusting Hue



White balance makes white objects look white. Although [AUTO] works well in most situations, you can choose other options if [AUTO] fails to make white objects appear white or if instead you wish to deliberately lend white objects a color cast.

- This setting can be accessed via:
  - The **WB** button (P. 203)
  - The LV super control panel (P. 204)
  - The menus (P. 204)
  - Live controls (P. 204)

White balance mode		Color temperature	Choose for
Auto white balance	AUTO	—	Most normal scenes (scenes containing objects that are white or close to white) <ul style="list-style-type: none"><li>This mode is recommended in most situations.</li><li>You can opt to preserve the colors seen under incandescent lighting (P. 205).</li></ul>
Preset white balance		5300 K	Sunlit outdoor scenes, sunsets, fireworks
		7500 K	Daylight shots of subjects in the shade
		6000 K	Shots taken in daylight under overcast skies
		3000 K	Subjects under incandescent lighting
		4000 K	Subjects under fluorescent lighting
		—	Underwater photography
One touch white balance		5500 K	Light sources with the same color temperature as flash lighting
		Value selected for one-touch white balance	Situations in which you want to set white balance for a specific subject <ul style="list-style-type: none"><li>Color temperature is set to a value metered from a white object under the lighting what will be used in the final photograph (P. 207).</li></ul>
Custom white balance	CWB	2000 K–14000 K	Situations in which you can identify the appropriate color temperature <ul style="list-style-type: none"><li>Choose a color temperature.</li></ul>

## ■ Access via the WB Button

1 Press the **WB** button.

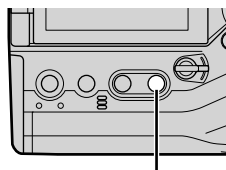

WB button

- [📷 WB] options will be displayed.



[📷 WB] options

2 Rotate the front or rear dial to highlight an option.

- Pressing the **INFO** button when [AUTO] is highlighted displays [📷 <sup>WB</sup>AUTO Keep Warm Color] options (P. 205).
- One-touch white balance (P. 207) and custom white balance options can be viewed by pressing the **INFO** button.
- You can also rotate the front or rear dial while pressing the **WB** button.

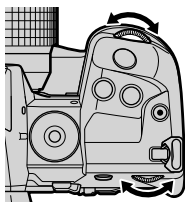

2

3 Press the shutter button halfway to select the highlighted option and exit.



- At default settings, white balance is assigned to the **WB** button. [📷 WB] can however be assigned to other controls if desired. Use [📷 Button Function] in ⚙ Custom Menu **B1** (P. 463).

## ■ Access via the LV Super Control Panel

White balance can be selected using the LV super control panel.

OK button → [WB] → Use the front dial to choose an option

- [WB] Keep Warm Color] options can be adjusted after you highlight [AUTO] in the [WB] menu and press the OK button (P. 205).
- To access settings for one-touch white balance (P. 207) or custom white balance, press the OK button to display [WB] options and then press the INFO button.
- When custom white balance ([CWB]) is selected, you can highlight the color temperature in the LV super control panel and choose a value by rotating the front dial.

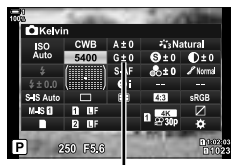

Color temperature

## ■ Menu Access

2 Adjust white balance using [WB] in Custom Menu G.

MENU button → \* tab → G tab → [WB] → Use Δ ∇ on the arrow pad to choose an option



## ■ Access via Live Controls

Highlight [WB] in the live controls and use <|> on the arrow pad to choose an option.

- For information on displaying live controls, see “Using Live Controls” (P. 68).



WB



## Preserving Warm Colors

## ( **WB AUTO** Keep Warm Color)



If desired, auto white balance can be adjusted to preserve the warm colors seen under incandescent lighting. White balance would normally be adjusted to make white colors appear white, but this feature can be used to preserve the ambiance created by incandescent lighting.

- This setting can be accessed via:
  - The **WB** button
  - The LV super control panel
  - The menus
  - Live controls
- To access this option via the **WB** button, the LV super control panel, or live controls, select [WB Auto] and press the **INFO** button.

### ■ Access via the WB Button

Select [WB Auto] ➔ **INFO** button ➔ Select [On]

### ■ Access via the LV Super Control Panel

Highlight [ WB] ➔ **OK** button ➔ Highlight [WB Auto] in the [ WB] menu ➔ **INFO** button ➔ Select [On]

### ■ Menu Access

**MENU** button ➔ Select [ **WB AUTO** Keep Warm Color] in  Custom Menu  ➔ Select [On]

### ■ Access via Live Controls

- For information on displaying live controls, see “Using Live Controls” (P. 68).
- Highlight [ WB] ➔ Select [WB Auto] ➔ **INFO** button ➔ Select [On]

## Fine-Tuning White Balance (📷 White Balance Compensation)

Fine-tune white balance. Separate values can be selected for each white balance option. Adjust settings as described below.

- This setting can be accessed via:
  - The LV super control panel
  - The menus

<b>A A (amber–blue) axis</b>	Positive values add a red cast, negative values a blue cast.
<b>G G (green–magenta) axis</b>	Positive values add a green cast, negative values a magenta cast.

### ■ Access via the LV Super Control Panel

- 1 Highlight [📷 WB] in the LV super control panel and choose a white balance option.

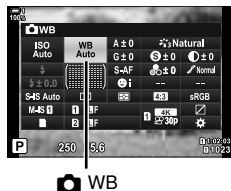

2

- 2 Highlight [A±0] or [G±0] using the arrow pad and highlight the desired value using the front dial.

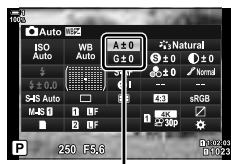

White balance fine-tuning

- 3 Press the shutter button halfway to select the highlighted option and exit the LV super control panel.



- White balance fine-tuning can be applied simultaneously to all white balance options.  
📷 [📷 All WB] (P. 545)



### ■ Menu Access

**MENU** button ➔ ⚙️ (Custom Menu) tab ➔ **G** (📷/WB/Color) tab ➔ [📷 WB] ➔ Highlight a white balance option and press **▶** on the arrow pad ➔ Highlight A±0 or G±0 using the **◀▶** buttons and use the **▲▼** buttons to choose a value (when [CWB] is selected, press the **▶** button one more time and choose a value using the **▲▼◀▶** buttons)

- Press the **⏏** (movie) button in the A or G fine-tuning display to preview the effect in the shooting display. Press the **⏏** button again to return to live view.

## Metering White Balance

### (One-Touch White Balance )

Set white balance to a value measured under the lighting that will be used in the final photograph. Use this option to fine-tune white balance when you find it hard to obtain the desired results with white balance compensation or preset white balance options such as  (sunlight) or  (overcast). The camera stores the metered value for quick recall as required.

- This setting can be accessed via:
  - The **WB** button
  - The menus (P. 209)
  - The LV super control panel (P. 209)
  - Live controls (P. 209)



Measure and store up to four values for one-touch white balance.

### ■ Access via the WB Button

- 1 Press the **WB** button.

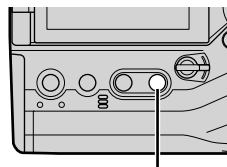



**WB** button

- [ **WB**] options will be displayed.



[ **WB**] options

- 2 Rotate the front or rear dial to highlight an option from  to .

- You can also choose a setting by holding the **WB** button and rotating the rear dial. Release the button to select the setting and return to the shooting display.



- 3** Press the **INFO** button.
- One-touch white balance measurement options will be displayed.

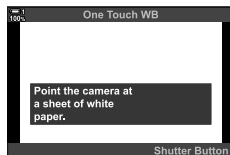

- 4** Frame a sheet of uncolored (white or gray) paper in the center of the display and release the shutter.
- Be sure the subject is free of shadows.
  - A confirmation dialog will be displayed.

- 5** Highlight [Yes] using the  $\Delta$   $\nabla$  buttons and press the **OK** button.

- The camera will store the setting as the value for the selected one-touch white balance option and exit to the shooting display.
- To exit without measuring white balance, highlight [No] and press the **OK** button. Repeat the process from Step 3.

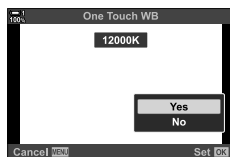

2

## ■ Using the One-Touch White Balance Button

[] can be assigned to a control. At default settings, it is assigned to the one-touch white balance button ().

- 1** Frame a sheet of uncolored (white or gray) paper in the center of the display.

- 2** Hold the one-touch WB button and press the shutter button all the way down.

- You will be prompted to choose the one-touch white balance option that will be used to store the new value.

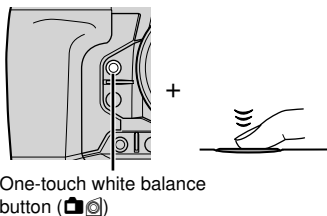

- 3** Highlight a one-touch white balance setting using  $\Delta$   $\nabla$  on the arrow pad and press the **OK** button.
- The new value will be saved as the value for the selected setting and the camera will exit to the shooting display.

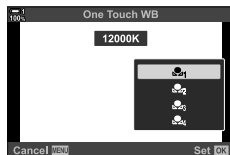

## ■ Access via the LV Super Control Panel

One-touch white balance can be selected using the LV super control panel.

[ WB] ➔ **OK** button ➔ Highlight to using the front dial ➔ **INFO** button ➔ Meter white balance

- Press the shutter button to meter white balance as described in “Access via the **WB** Button” (P. 207).

## ■ Menu Access

The menus can be used only to recall previously-metered values for one-touch white balance.

**MENU** button ➔ (Custom Menu) tab ➔ **G** (/WB/Color) tab ➔ [ WB] ➔ Select an option from to using on the arrow pad

## ■ Access via Live Controls

One-touch white balance can be metered using live controls.

- For information on displaying live controls, see “Using Live Controls” (P. 68).

**OK** button ➔ [ WB] ➔ Highlight an option from to using on the arrow pad



WB

- To view the white balance metering display and measure a new value for the currently-selected one-touch white balance option, press the **INFO** button.

Shoot at resolutions higher than that of the image sensor. The camera takes a series of shots while moving the image sensor and combines them to create a single high-resolution photo. Use this option to capture details that normally would not be visible even at high zoom ratios.

- This setting can be accessed via:
  - The menus (P. 210, 212)
  - The LV super control panel (P. 212)
  - The button (P. 212)
  - Live controls (P. 212)
- Pictures are recorded in JPEG (**50M F** or **25M F**) or RAW + JPEG format. In RAW + JPEG format, the camera will record both the high-resolution picture and an unprocessed RAW image (extension "\*.ORI"). Select High Res Shot before adjusting [] "High Res Shot Image Quality ()" (P. 213)
- Unprocessed RAW (ORI) images can be viewed using the latest version of Olympus Workspace.

<b>High Res Shot (Off, 0–30 sec)</b>	Choose how long the camera waits to begin shooting after the shutter button is pressed all the way down. Use this option to prevent blur caused by the camera moving when the shutter button is pressed. Select [Off] to disable High Res Shot.
<b> Charge Time</b>	Choose how long the camera waits for the flash to charge for High Res Shots taken with the flash.
<b>Shooting Method</b>	<p>[Tripod]: Take photos with the camera on a tripod or otherwise secured. RAW pictures are recorded at a size of 80 megapixels (10400 × 7792).</p> <ul style="list-style-type: none"> <li>The flash sync speed is 1/50 s.</li> <li>The maximum value for [ ISO] is 1600.</li> </ul> <p>[Handheld]: Take hand-held shots. The camera takes slightly longer to record pictures. RAW pictures are recorded at a size of 50 megapixels (8200 × 6132).</p> <ul style="list-style-type: none"> <li>The flash is disabled.</li> <li>The maximum value for [ ISO] is 6400.</li> </ul>

- Press the **MENU** button to display the menus.
- Highlight [High Res Shot] in Shooting Menu 2 and press on the arrow pad.
  - [High Res Shot] options will be displayed.



- 3** Highlight the desired item and press the **▷** button.
- Press the **OK** button after adjusting each of:
    - [High Res Shot]: Highlight [0 sec] using the **▽** button and press the **▷** button. Choose a wait time.
    - [Charge Time]: Choose a time.
    - [Shooting Method]: Select [Tripod] or [Handheld].



- 4** Press the **OK** button when settings are complete.
- Shooting Menu 2 will be displayed.
- 5** Press the **MENU** button repeatedly to exit the menus.



- A  icon will be displayed. The icon will flash if the camera is not steady. The icon stops flashing when the camera is steady and ready to shoot.
- After enabling High Res Shot, check the option selected for image quality. Image quality can be adjusted in the LV super control panel.



Camera readying for High Res Shot (flashes)



2

**6** Take pictures.

- The  will flash to warn that shots may be blurred by camera shake. Keep the camera steady.
- Shooting is complete when the green  icon clears from the display.
- The camera will automatically create the composite image when shooting is complete. A message will be displayed during this process.
- [S-IS Off] is automatically selected for  Image Stabilizer] when [Tripod] is chosen for [Shooting Method], [S-IS AUTO] when [Handheld] is selected.
- The maximum wait time for [Shooting Method] > [Handheld] is 1 second.
- There is no need to choose an option for [Charge Time] when using a compatible flash unit. During RC flash photography, the maximum flash wait time is 4 s and the flash control mode is fixed at MANUAL.
- High Res Shot is not available in mode **B**.
- The following cannot be used:
  - interval-timer photography, multiple exposure, keystone compensation, bracketing, fisheye correction, and the live ND filter.
- Pictures taken with [e-Portrait] or an art filter selected for picture mode will be recorded in [Natural] mode.
- If the camera is unable to record a composite image due to blur or other factors and [JPEG] is selected for image quality, a single JPEG image will be recorded. If [RAW+JPEG] is selected, both a RAW (ORF) and a JPEG image will be recorded.
- Mottling may be visible in pictures taken under fluorescent or LED lighting or other similar light sources.

High Res Shot can also be selected using the  button, the LV super control panel, and live controls. If High Res Shot does not appear in the drive mode list, it can be added using the menus (P. 210).

## ■ Access via the Button

Press the  button and rotate the rear dial to select .

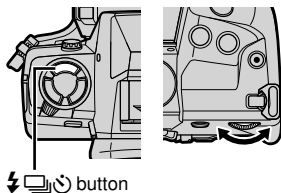

- To view [Shooting Method] options, press the **INFO** button.



2

## ■ Access via the LV Super Control Panel

High Res Shot can also be accessed via the LV super control panel.

**OK** button  $\rightarrow$  Highlight  (sequential shooting/self-timer) and press the **OK** button  $\rightarrow$  Select 



 (sequential shooting/self-timer)

## ■ Access via Live Controls



Highlight  (sequential shooting/self-timer) in the live controls and use  $\triangleleft$ / $\triangleright$  on the arrow pad to choose an option.

- For information on displaying live controls, see “Using Live Controls” (P. 68).



 (sequential shooting/self-timer)

## ■ Access via the Menus

**MENU** button  $\rightarrow$   (Shooting Menu 1) tab  $\rightarrow$    $\rightarrow$    $\rightarrow$  Select 



## High Res Shot Image Quality



Enabling High Res Shot automatically sets image quality to an option compatible with the higher resolution. Before shooting, be sure to check the option selected for image quality.

- This setting can be accessed via:
  - The LV super control panel
  - The menus (P. 214)
  - Live controls (P. 214)

<b>50M F</b>	High Res Shots are saved in JPEG [Fine] format at a size of 50 megapixels (8160 × 6120).
<b>25M F</b>	High Res Shots are saved in JPEG [Fine] format at a size of 25 megapixels (5760 × 4320).
<b>50M F+RAW</b>	High Res Shots are saved in RAW and JPEG [Fine] formats at a size of 50 megapixels (8160 × 6120).
<b>25M F+RAW</b>	High Res Shots are saved in RAW and JPEG [Fine] formats at a size of 25 megapixels (5760 × 4320).

- RAW pictures are recorded at a size of 8200 × 6132 when [Handheld] is selected for [Shooting Method] and at a size of 10400 × 7792 when [Tripod] is selected.

### ■ Access via the LV Super Control Panel

**1** Enable High Res Shot before proceeding.



**2** Choose the  setting for Slot 1 (1) or Slot 2 (2) in the LV super control panel.

- Each slot has its own image quality option. When [Dual Independent ↓] or [Dual Independent ↑] is selected for  [Save Settings] (P. 72), a different setting can be used for each slot. Otherwise, the selected setting will apply to both Slot 1 and Slot 2.



 image quality

**3** Highlight an option using the front dial.

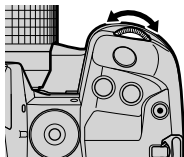

**4** Press the shutter button halfway to exit the LV super control panel.

- The option selected for image quality may change if you choose a different option for [Save Settings] (P. 72) or insert a memory card with space remaining; before shooting, be sure to check the option selected for image quality. In particular, image quality will require readjustment after [Dual Independent ↓] or [Dual Independent ↑] is selected.

## ■ Menu Access

Image quality can be adjusted via the menus. Use [MENU] in Shooting Menu 1.

**MENU** button → [MENU] (Shooting Menu 1) tab → [MENU] → Press ▷ on the arrow pad to view options

## ■ Access via Live Controls

Image quality can be adjusted using live controls.

- For information on displaying live controls, see "Using Live Controls" (P. 68).

**OK** button → [MENU] → Press ◁▷ on the arrow pad to view options













 image quality







Choose how pictures are processed during shooting to enhance color, tone, and other properties. Choose from preset picture modes according to your subject or artistic intent. Contrast, sharpness, and other settings can be adjusted separately for each mode. You can also add artistic effects using art filters. Art filters give you the option of added frame effects and the like. Adjustments to individual parameters are stored separately for each picture mode and art filter.

- This item applies during both still photography and movie recording.

### Standard Picture Modes

 <b>i-Enhance</b>	The camera adjusts colors and contrast for optimal results according to the type of subject (P. 226).
 <b>Vivid</b>	Choose for vivid colors.
 <b>Natural</b>	Choose for natural colors.
 <b>Muted</b>	Choose for pictures that will later be retouched.
 <b>Portrait</b>	Enhance skin tones.
 <b>Monochrome</b>	Record pictures in monochrome. You can apply color filter effects and choose a tint (P. 224).
 <b>Custom</b>	Adjust picture mode parameters to create a custom version of a selected picture mode.
 <b>e-Portrait</b>	Smooth complexions.
 <b>Underwater</b>	Process pictures to preserve the vivid colors seen under water. <ul style="list-style-type: none"> <li>• We recommend choosing [Off] for [⚡+WB] (P. 540) when this option is selected.</li> </ul>
 <b>Color Creator</b>	Adjust hue and color to suit your creative intent (P. 229).

### Art Filters

 <b>Pop Art</b>	Enhance the beauty of colors.
 <b>Soft Focus</b>	Use soft tones for an airy, dreamlike effect.
 <b>Pale&amp;Light Color</b>	Diffuse light throughout the image, increasing exposure slightly and setting your subject adrift in a soft glow.
 <b>Light Tone</b>	Soften highlights and shadows for a refined, serene effect.
 <b>Grainy Film</b>	Choose for the forceful, bold effect typical of black-and-white film.
 <b>Pin Hole</b>	Reduce peripheral illumination for the effect of a photo taken with an old toy camera.

ART 7	<b>Diorama</b>	Increase saturation and contrast and blur out-of-focus areas to make the picture look like a photo of a miniature.
ART 8	<b>Cross Process</b>	Choose for an edgy, surrealistic effect. Choose Cross Process II for a color balance that exaggerates magenta.
ART 9	<b>Gentle Sepia</b>	Choose for a peaceful, refined effect that softens the image overall, creating serene pictures with clearly-defined shadows.
ART 10	<b>Dramatic Tone</b>	Selectively enhance contrast to further differentiate light from dark.
ART 11	<b>Key Line</b>	Enhance edges for a photo-illustration effect.
ART 12	<b>Watercolor</b>	Dramatically brighten shadows to give the effect of a scene painted in bright pastel colors on white canvas, and add soft outlines for warm, bright results.
ART 13	<b>Vintage</b>	Mimic the effects of a discolored and faded vintage print for a nostalgic, slice-of-life effect.
ART 14	<b>Partial Color</b>	Enhance the impression created by your subject by recording only selected hues in color while the rest of the picture is in black-and-white.
ART 15	<b>Bleach Bypass</b>	The “bleach bypass” effect, which you may recognize from motion pictures and the like, can be used to great effect in shots of streetscapes or metal objects.
ART 16	<b>Instant Film</b>	A contemporary take on the shadow and skin tones typical of film.

- Art filters apply only to the JPEG copy. [RAW+JPEG] is automatically selected for image quality in place of [RAW].
- Depending on the scene, the effects of some settings may not be visible, while in other cases tone transitions may be ragged or the image rendered more “grainy”.



- You can choose the picture modes displayed using [Picture Mode Settings] (P. 520) in Custom Menu .

## Choosing a Picture Mode

This setting can be accessed via:

- The LV super control panel
- The menus (P. 218)
- Live controls

### ■ Access via the LV Super Control Panel

- 1 Highlight [Picture Mode] in the LV super control panel.

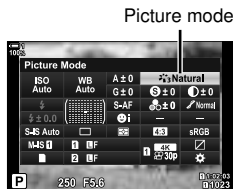

- 2 Highlight an option using the front dial.
  - Depending on the option selected, picture mode parameters may be displayed in LV super control panel. Adjust parameters as desired (P. 220–226).

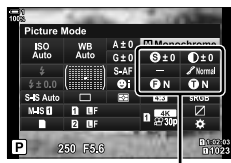

Changes depending on mode selected

- 3 Press the shutter button halfway to select the highlighted option and exit the LV super control panel.

### ■ Access via Live Controls

Picture mode can be accessed via live controls.

- For information on displaying live controls, see “Using Live Controls” (P. 68).



**OK** button ➔ [Picture Mode] ➔ Press **▶** on the arrow pad to view options

- When [Color Creator] (P. 229) or the [Partial Color] art filter (P. 231) is selected, you can press the **INFO** button and adjust saturation and hue using the dials.

## ■ Menu Access

Use [Picture Mode] in Shooting Menu 1.

**MENU** button → tab → [Picture Mode] → Use  $\Delta$   $\nabla$  on the arrow pad to select → Press the  $\triangleright$  button to view picture mode parameters or filter effects

- You can adjust the individual parameters for each picture mode. You can also adjust parameters in the LV super control panel. Changes to parameters in the LV super control panel also apply to the menus.

Picture mode	Available parameters
<b>i-Enhance</b>	[Sharpness]/[Contrast]/[Saturation]/[Gradation]/[Effect]
<b>Vivid</b>	[Sharpness]/[Contrast]/[Saturation]/[Gradation]
<b>Natural</b>	
<b>Muted</b>	
<b>Portrait</b>	
<b>Monochrome</b>	
<b>Custom</b>	—
<b>e-Portrait</b>	
<b>Color Creator (P. 229)</b>	
<b>Underwater</b>	
<b>Pop Art</b>	[Add Effects] The options available vary with the filter selected. [Soft Focus Effect]/[Pin Hole Effect]/[White Edge Effect]/ [Frame Effect]/[Star Light Effect]/[Blur Effect: Top and Bottom]/[Blur Effect: Left and Right]/[Shade Effect: Top and Bottom]/[Shade Effect: Left and Right]/[Color Filter]/[Monochrome Color]
<b>Soft Focus</b>	
<b>Pale&amp;Light Color</b>	
<b>Light Tone</b>	
<b>Grainy Film</b>	
<b>Pin Hole</b>	
<b>Diorama</b>	
<b>Cross Process</b>	
<b>Gentle Sepia</b>	
<b>Dramatic Tone</b>	
<b>Key Line</b>	
<b>Watercolor</b>	
<b>Vintage</b>	
<b>Partial Color (P. 231)</b>	
<b>Bleach Bypass</b>	
<b>Instant Film</b>	

## Creating Custom Picture Modes (C Custom Picture Mode)

Create custom picture modes by editing the parameters for existing modes. Custom picture modes can be created using [i-Enhance], [Vivid], [Natural], [Muted], [Portrait], and [Monochrome].

- 1 Press the **MENU** button to display the menus.
- 2 Highlight [Picture Mode] in Shooting Menu 1 and press **▷** on the arrow pad.



- 3 Highlight [Custom] using the  $\Delta$   $\nabla$  buttons and press the **▷** button.
  - Custom picture mode options will be displayed.

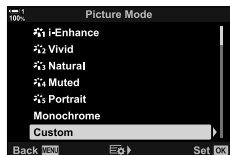

- 4 Adjust settings using the  $\Delta$   $\nabla$  buttons.
  - Choose a [Picture Mode] and adjust [Sharpness], [Contrast], [Saturation], [Gradation], [Effect], [Color Filter], and [Monochrome Color].
  - Highlight items using the  $\Delta$   $\nabla$  buttons and press the **▷** button to view settings. After adjusting settings, press the **OK** button to return to the [Custom] menu.

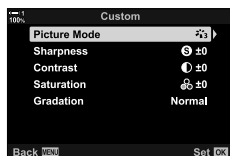

- 5 Press the **MENU** button repeatedly to exit the menus.
- 6 To use the custom settings, select [C Custom] for picture mode.

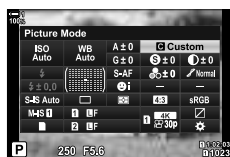

2

## Adjusting Sharpness (Sharpness)

Adjust image sharpness. Outlines can be emphasized for a sharp, clear picture. Settings are stored separately for each picture mode.

- This setting can be accessed via:
  - The LV super control panel
  - The menus

<b>Hi (+)</b>	Increase sharpness. Outlines are more sharply defined.
<b>Lo (-)</b>	Lower sharpness. Outlines are less sharply defined.

### ■ Access via the LV Super Control Panel

- 1 Highlight [Sharpness] in the LV super control panel.

Sharpness



2

- 2 Highlight an option using the front dial.
- 3 Press the shutter button halfway to select the highlighted option and exit the LV super control panel.

### ■ Menu Access

Adjust sharpness using [Picture Mode] in  Shooting Menu 1.

**MENU** button →  (Shooting Menu 1) tab → [Picture Mode] → Highlight a picture mode using  $\Delta$ / $\nabla$  on the arrow pad and press the  $\triangleright$  button → Highlight [Sharpness] using the  $\Delta$ / $\nabla$  buttons and press the  $\triangleright$  button → Use the  $\Delta$ / $\nabla$  buttons to choose an option



## Adjusting Contrast

## (Contrast)

Adjust image contrast. Increasing contrast heightens the difference between bright and dark areas for a harder, more well-defined picture. Settings are stored separately for each picture mode.

- This setting can be accessed via:
  - The LV super control panel
  - The menus

<b>Hi (+)</b>	Increase contrast. Pictures are harder and more well-defined.
<b>Lo (-)</b>	Lower contrast. Pictures are softer.

### ■ Access via the LV Super Control Panel



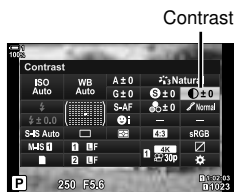









- 1 Highlight [Contrast] in the LV super control panel.



- 2 Highlight an option using the front dial.
- 3 Press the shutter button halfway to select the highlighted option and exit the LV super control panel.

### ■ Menu Access

Adjust contrast using [Picture Mode] in  Shooting Menu 1.

**MENU** button  (Shooting Menu 1) tab  [Picture Mode]  Highlight a picture mode using   on the arrow pad and press the  button  Highlight [Contrast] using the   buttons and press the  button  Use the   buttons to choose an option

## Adjusting Vividness

(Saturation)

Adjust color saturation. Increasing saturation makes pictures more vivid. Settings are stored separately for each picture mode.

- This setting can be accessed via:
  - The LV super control panel
  - The menus

<b>Hi (+)</b>	Increase saturation. Colors are more vivid.
<b>Lo (-)</b>	Lower saturation. Colors are softer.

### ■ Access via the LV Super Control Panel

- 1 Highlight [Saturation] in the LV super control panel.

Saturation

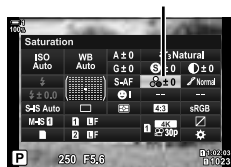

2

- 2 Highlight an option using the front dial.
- 3 Press the shutter button halfway to select the highlighted option and exit the LV super control panel.

### ■ Menu Access





Adjust saturation using [Picture Mode] in  Shooting Menu 1.

**MENU** button →  (Shooting Menu 1) tab → [Picture Mode] → Highlight a picture mode using  $\Delta$ / $\nabla$  on the arrow pad and press the  $\triangleright$  button → Highlight [Saturation] using the  $\Delta$ / $\nabla$  buttons and press the  $\triangleright$  button → Use the  $\Delta$ / $\nabla$  buttons to choose an option

## Adjusting Shading (Gradation)

Adjust color brightness and shading. Bring pictures closer to what you envisage by, for example, brightening the entire picture. Settings are stored separately for each picture mode.

- This setting can be accessed via:
  - The LV super control panel
  - The menus

 <b>Auto (Shadow Adj)</b>	Brightness is adjusted separately for every detail. A good choice for high-contrast images where shadows or highlights might otherwise be lost.
 <b>Normal (Gradation Normal)</b>	Optimal shading. Recommended in most circumstances.
 <b>High (Gradation High Key)</b>	Suited to bright subjects.
 <b>Low (Gradation Low Key)</b>	Suited to dark subjects.

### ■ Access via the LV Super Control Panel

- 1 Highlight [Gradation] in the LV super control panel.

Gradation



- 2 Highlight an option using the front dial.
- 3 Press the shutter button halfway to select the highlighted option and exit the LV super control panel.

### ■ Menu Access

Adjust shading using [Picture Mode] in  Shooting Menu 1.

**MENU** button →  (Shooting Menu 1) tab → [Picture Mode] → Highlight a picture mode using  $\Delta$   $\nabla$  on the arrow pad and press the  $\triangleright$  button → Highlight [Gradation] using the  $\Delta$   $\nabla$  buttons and press the  $\triangleright$  button → Use the  $\Delta$   $\nabla$  buttons to choose an option

## Color Filters for Black-and-White Photography (Color Filter)

Color filter effects can be added when [Monochrome] is selected for picture mode (P. 215). Depending on the color of the subject, color filter effects can make subjects brighter or enhance contrast. Orange adds more contrast than yellow, red more contrast than orange. Green is a good choice for portraits and the like.

- This setting can be accessed via:
  - The LV super control panel
  - The menus

<b>N:None</b>	No filter effect.
<b>Ye:Yellow</b>	White clouds stand out clearly against natural-looking skies.
<b>Or:Orange</b>	Slightly brings out blue skies or the light of the setting sun.
<b>R:Red</b>	Further brings out blue skies or autumn foliage.
<b>G:Green</b>	Adds warmth to skin tones in portraits. The green filter also emphasizes the reds in lipstick.

### ■ Access via the LV Super Control Panel

This option is available when [Monochrome] is selected for [Picture Mode].

- 1 Highlight [Color Filter] in the LV super control panel.

Color filter



- 2 Highlight an option using the front dial.
- 3 Press the shutter button halfway to select the highlighted option and exit the LV super control panel.

### ■ Menu Access

Choose a filter using [Picture Mode] in Shooting Menu 1.

**MENU** button (Shooting Menu 1) tab [Picture Mode] Highlight [Monochrome] using  $\Delta$   $\nabla$  on the arrow pad and press the  $\triangleright$  button Highlight [Color Filter] using the  $\Delta$   $\nabla$  buttons and press the  $\triangleright$  button Use the  $\Delta$   $\nabla$  buttons to choose an option

## Monochrome Tints (Monochrome Color)

Add a tint to black-and-white pictures in the [Monochrome] picture mode (P. 215).

- This setting can be accessed via:
  - The LV super control panel
  - The menus

<b>N:Normal</b>	Shoot in black and white.
<b>S:Sepia</b>	Shoot in sepia-tinted monochrome.
<b>B:Blue</b>	Shoot in blue-tinted monochrome.
<b>P:Purple</b>	Shoot in purple-tinted monochrome.
<b>G:Green</b>	Shoot in green-tinted monochrome.

### ■ Access via the LV Super Control Panel

This option is available when [Monochrome] is selected for [Picture Mode].

- 1 Highlight [Monochrome Color] in the LV super control panel.

Monochrome Color

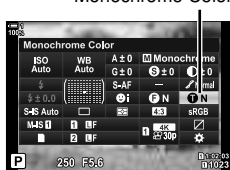

- 2 Highlight an option using the front dial.
- 3 Press the shutter button halfway to select the highlighted option and exit the LV super control panel.

### ■ Menu Access

Choose a tint using [Picture Mode] in  Shooting Menu 1.

**MENU** button  $\Rightarrow$   (Shooting Menu 1) tab  $\Rightarrow$  [Picture Mode]  $\Rightarrow$  Highlight [Monochrome] using  $\Delta$   $\nabla$  on the arrow pad and press the  $\triangleright$  button  $\Rightarrow$  Highlight [Monochrome Color] using the  $\Delta$   $\nabla$  buttons and press the  $\triangleright$  button  $\Rightarrow$  Use the  $\Delta$   $\nabla$  buttons to choose an option

## Adjusting i-Enhance Effects

(Effect)

Choose the strength of the effect for [i-Enhance].

- This setting can be accessed via:
  - The LV super control panel
  - The menus

<b>Low (Effect: Low)</b>	Effect reduced.
<b>Standard (Effect: Standard)</b>	Standard effect.
<b>High (Effect: High)</b>	Effect heightened.

### ■ Access via the LV Super Control Panel

This option is available when [i-Enhance] is selected for [Picture Mode].

- 1 Highlight [Effect] in the LV super control panel.

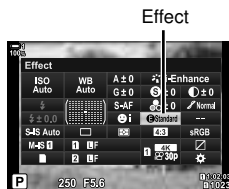

- 2 Highlight an option using the front dial.
- 3 Press the shutter button halfway to select the highlighted option and exit the LV super control panel.

### ■ Menu Access

Choose the strength of the effect using [Picture Mode] in Shooting Menu 1.

**MENU** button (Shooting Menu 1) tab [Picture Mode] Highlight [i-Enhance] using on the arrow pad and press the button Highlight [Effect] using the buttons and press the button Use the buttons to choose an option

## Choosing a Tone Curve (Highlight&Shadow Control)

Adjust brightness separately for highlights, mid-tones, and shadows. You gain greater control over exposure than you would with exposure compensation alone. You can selectively make highlights darker or shadows brighter.

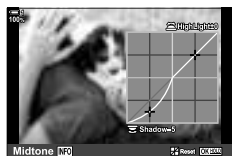

Adjusting shadows



Adjusting mid-tones

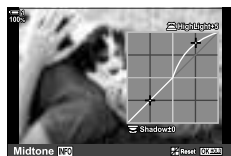

Adjusting highlights

(The illustrations above show the display when the highlight and shadow control is accessed via a button and the LV super control panel.)

- This setting can be accessed via:
  - The  button
  - The LV super control panel (P. 228)

### ■ Access via the Button

- 1 Press the  button.
  - Exposure compensation will be highlighted in the display.

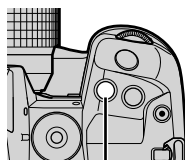



 button

- 2 Press the **INFO** button.
  - A tone curve icon will be displayed.
  - Press the **INFO** button to cycle from shadows to mid-tones to highlights and back to exposure compensation again.



 (Highlight and shadow control)

- 3 Select the desired setting using   on the arrow pad.
  - Choose from values between -7 and +7.
  - To reset, press and hold the **OK** button.
- 4 Press the **OK** button to save changes.
  - You can also save changes by pressing the shutter button halfway.



- Exposure compensation, and with it highlight and shadow control, can be assigned to controls other than the button. Use [ Button Function] (P. 463) in Custom Menu **B1**.
- Assigning [Multi Function] to the control gives you direct access to [Highlight&Shadow Control]. “Multi-Function Button Options (Multi Function)” (P. 470)

## ■ Access via the LV Super Control Panel

**1** Highlight [Highlight&Shadow Control] in the LV super control panel and press the **OK** button.

- A tone curve will be displayed.

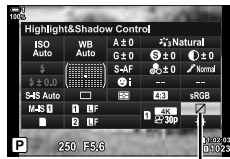

Highlight & shadow control

**2** Press the **INFO** button to choose the desired tone range.

- The tone range changes each time the button is pressed.

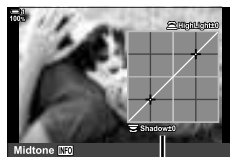

Selected tone range

**3** Rotate the dials to choose the desired setting.

- **[Hi. & Sh.] selected**  
Adjust highlights using the front dial and shadows using the rear dial.
- **[Midtone] selected**  
Use the front or rear dial.
- Press and hold the **OK** button to restore the default curve.

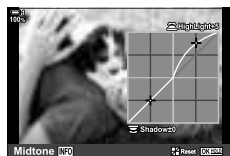

**4** Press the **OK** button to save changes.

- You can also save changes by pressing the shutter button halfway.



## Hue and Saturation (Color Creator)

The camera permits intuitive adjustments to color saturation and hue. Choose from 30 hues and 8 levels of saturation. The results can be previewed in the display.

[Color Creator] is a picture mode option. Settings can be accessed directly using [Multi Function]. Assign [Multi Function] to a button using [Button Function] (P. 463) in **Custom Menu B1**.

- This setting can be accessed via:
  - The LV super control panel
  - Live controls (P. 230)
  - The menus (P. 230)

### ■ Access via the LV Super Control Panel

- 1 Highlight [Picture Mode] in the LV super control panel.

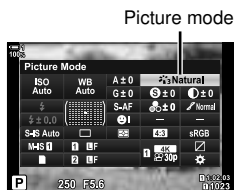

- 2 Highlight [Color Creator] using the front dial.
  - A **Color/Vivid** option will be displayed in the LV super control panel.

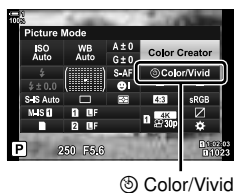

- 3 Highlight [Color/Vivid] using **Δ ∇** on the arrow pad and press the **OK** button.



- 4** Adjust saturation and hue.
- Rotate the front dial to adjust hue.
  - Rotate the rear dial to adjust saturation.
  - Press and hold the **OK** button to restore default settings.



- 5** Press the **OK** button to save changes.
- You can also save changes by pressing the shutter button halfway.

## ■ Menu Access

The color creator can also be accessed via the menus. Saturation and hue, however, cannot be adjusted via the menus. The menus can be used to recall previously-saved values only.

**MENU** button ➔ (Shooting Menu 1) tab ➔ [Picture Mode] ➔ [Color Creator]

2

## ■ Access via Live Controls

The color creator can be accessed using live controls.

- For information on displaying live controls, see "Using Live Controls" (P. 68).



Picture mode

**OK** button ➔ [Picture Mode] ➔ Press on the arrow pad to highlight [Color Creator]  
➔ Press the **INFO** button and adjust saturation and hue

- Pictures taken with [RAW] selected for will be recorded using [RAW+JPEG] instead.
- The color creator is not available during HDR or multiple-exposure photography. If [Color Creator] selected for picture mode when either option is enabled, the camera will select [Natural] instead.

## “Leave Color” Effects (Partial Color)

Shoot in black-and-white while capturing objects of a selected hue in color. For example, you can shoot in black-and-white while leaving only reds in color. The results can be previewed in the display.

[Partial Color] is an art filter option. Settings can be adjusted when it is selected for picture mode. Choose from three “leave color” filters (I through III).

- 1 Highlight [Picture Mode] in the LV super control panel.

Picture mode

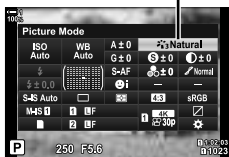

- 2 Highlight [ART14 I], [ART14 II], or [ART14 III] using the front dial.

- [Color] and [Effect] options will be displayed in the LV super control panel.



Color

Effect

- 3 Highlight [Color] using  $\Delta$   $\nabla$  on the arrow pad and press the **OK** button.

- A color ring will be displayed.



- 4 Select a color using the dials.

- 5 Press the **OK** button to save changes.

- You can also save changes by pressing the shutter button halfway.

## Choosing a Color Space (Color Space)

Choose a color space to ensure accurate color reproduction when photos are output to a printer or external display.

<b>sRGB</b>	The established color space standard for Windows systems. It is widely supported across displays, printers, digital cameras, and computer applications. This setting is recommended in most circumstances.
<b>AdobeRGB</b>	A color space standard defined by Adobe Systems Inc. It can reproduce a wider gamut of colors than sRGB. Accurate color reproduction is available only with software and devices (displays, printers, and the like) that support this standard.

- 1 Highlight [Color Space] in the LV super control panel.

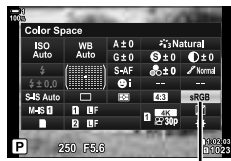

Color space

- 2 Highlight an option using the front dial.
- 3 Press the shutter button halfway to select the highlighted option and exit the LV super control panel.

### ■ Menu Access

The color space can be selected via the menus.

**MENU** button ➔ **G** (◀️/WB/Color) tab ➔ [Color Space] ➔ Use  $\Delta$   $\nabla$  on the arrow pad to choose an option

- [AdobeRGB] is not available in art filter picture modes or with HDR photography. [sRGB] is selected automatically.

## 2-14 Effects

This section deals with multiple exposure, zoom, and other features used to manipulate the image during shooting. It also covers features such as exposure bracketing, which varies exposure over a series of pictures, and focus stacking.

### Aspect Ratio

### (Image Aspect)

Choose the ratio of width to height for pictures according to your intent or your goals for printing or the like. In addition to the standard aspect (width-to-height) ratio of [4:3], the camera offers settings of [16:9], [3:2], [1:1], and [3:4].

- This setting can be accessed via:
  - The LV super control panel (P. 234)
  - Live controls (P. 234)
  - The menus (P. 234)

## ■ Access via the LV Super Control Panel

- 1 Highlight [Image Aspect] in the LV super control panel.

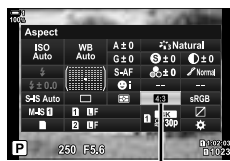

Image aspect

- 2 Highlight an option using the front dial.
- 3 Press the shutter button halfway to select the highlighted option and exit the LV super control panel.

## ■ Menu Access

Aspect ratio can be selected using [Image Aspect] in Shooting Menu 1.



MENU button → (Shooting Menu 1) tab → [Image Aspect] → Use  $\Delta$   $\nabla$  on the arrow pad to choose an option

## ■ Access via Live Controls

Highlight [Image Aspect] in the live controls and use  $\triangleleft$   $\triangleright$  on the arrow pad to choose an option.





- For information on displaying live controls, see “Using Live Controls” (P. 68).



Image aspect

- JPEG images are recorded at the selected aspect ratio. RAW images are the same size as the image sensor and are recorded at an aspect ratio of 4:3 with a tag indicating the aspect ratio selected. A crop indicating the selected aspect ratio is displayed when images are played back.

This option takes a crop at the center of the frame the same dimensions as the size option currently selected for image quality and zooms it in to fill the display. The zoom ratio increases by about 2x. This allows you to zoom in past the lens' maximum focal length, making it a good choice when you are unable to switch lenses or find it difficult to get any closer to your subject.

- 1 Press the **MENU** button to display the menus.
- 2 Highlight [Digital Tele-converter] in  Shooting Menu 1 and press  on the arrow pad.
- 3 Highlight [On] using the   buttons and press the **OK** button.
- 4 Press the **MENU** button to exit the menus.
  - When [On] is selected, the zoom ratio increases by 2x and a  icon is displayed. Pictures will be recorded at the new zoom ratio.



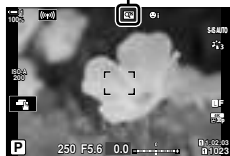

Digital teleconverter



2

- The digital teleconverter cannot be used with multiple exposure, keystone compensation, or fisheye correction.
- JPEG images are recorded at the selected zoom ratio. In the case of RAW images, a frame shows the zoom crop. A frame showing the zoom crop is displayed on the image during playback.
- During zoom, the size of the AF targets increases and their number decreases.



The digital teleconverter can be assigned to a camera control using  Button Function in  Custom Menu **B1**, allowing the digital teleconverter to be turned on or off at the touch of a button (P. 463).

## Varying Settings Little-by-Little over a Series of Shots (Bracketing)

Bracketing is used to vary shooting settings such as exposure and white balance over a series of shots. Depending on the setting, you may be able to combine several different forms of bracketing. Use bracketing if you are unsure what settings to use or lack the time needed to change settings during shooting. You can also store bracketing settings and later recall them simply by turning bracketing on.

- This setting can be accessed via:
  - The **BKT** button (P. 240)
  - The menus (P. 241)
- Flash bracketing cannot be used in combination with:  
HDR photography, interval-timer photography, keystone compensation, multiple exposure, High Res Shot, or fisheye correction.
- Exposure, flash, and focus bracketing are not available in mode **B**.
- Bracketing will not start if there is not enough space on the memory card for all the shots in the bracketing sequence.

2

### AE BKT (Exposure Bracketing)



Vary exposure over a series of shots. You choose the amount of variation and the number of shots. The camera takes a shot at a new exposure setting each time the shutter button is pressed all the way down. Bracketing ends after the selected number of shots has been taken. In burst shooting modes, the camera will take pictures while the shutter button is pressed all the way down, ending when the selected number of shots has been taken.



The following options are available:

- **Bracketing amount:** 0.3, 0.7, or 1.0 EV
- **Number of shots:** 2, 3, 5, or 7

A  icon is displayed in green until all the shots in the bracketing sequence have been taken. The first shot is taken at current exposure settings, followed first by the shots with reduced exposure and then by the shots with increased exposure.

The settings used to alter exposure vary with the shooting mode.

<b>P</b> (program AE)	Both aperture and shutter speed
<b>A</b> (aperture-priority AE)	Shutter speed
<b>S</b> (shutter-priority AE)	Aperture
<b>M</b> (manual)	<ul style="list-style-type: none"><li>• Shutter speed (option other than [AUTO] selected for  ISO)</li><li>• ISO sensitivity ([AUTO] selected for  ISO)</li></ul>

- If exposure compensation is enabled before shooting begins, the camera will vary exposure around the selected value.
- Changing the option selected for [EV Step] (P. 530) in  Custom Menu  changes the options available for bracketing amount.
- Exposure bracketing cannot be combined with flash or focus bracketing.



## **WB BKT (White Balance Bracketing)**

The camera varies white balance to record a series of pictures. You choose the color axis, the amount, and the number of shots.

Shooting ends after a single shot. The camera takes one picture when the shutter button is pressed all the way down and automatically processes it to record the selected number of shots.

The following options are available:

- **Color axis:** A-B (amber–blue) and G-M (green–magenta)
- **Bracketing amount:** 2, 4, or 6 steps
- **Number of shots:** 3 pictures are created from a single shot

The first copy is recorded at current white balance settings, the second using a negative value for compensation, and the third using a positive value.

- If white balance fine-tuning is enabled before shooting begins, the camera will vary white balance around the selected value.
- White balance bracketing cannot be combined with art filters or focus bracketing.



## **FL BKT (Flash Bracketing)**

The camera varies flash level (output) over a series of shots. You choose the amount of variation and the number of shots. The camera takes a shot at a new flash level each time the shutter button is pressed all the way down. Bracketing ends after the selected number of shots has been taken. In burst shooting modes, the camera will take pictures while the shutter button is pressed all the way down, ending when the selected number of shots has been taken.

The following options are available:

- **Bracketing amount:** 0.3, 0.7, or 1.0 EV
- **Number of shots:** 3

A  icon is displayed in green until all the shots in the bracketing sequence have been taken. The first shot is taken at current flash settings, followed first by the shot with reduced flash output and then by the shot with increased flash output.

- If flash compensation is enabled before shooting begins, the camera will vary flash output around the selected value.
- Changing the option selected for [EV Step] (P. 530) in  Custom Menu  changes the options available for bracketing amount.
- Flash bracketing cannot be combined with exposure or focus bracketing.
- Flash bracketing is not available in mode **B**.



## **ISO BKT (ISO Sensitivity Bracketing)**

The camera varies ISO sensitivity to record a series of pictures. You choose the amount and the number of shots. Shooting ends after a single shot. The camera takes one picture when the shutter button is pressed all the way down and automatically processes it to record the selected number of shots.

The following options are available:

- **Bracketing amount:** 0.3, 0.7, or 1.0 EV
- **Number of shots:** 3

The first copy is recorded at the current ISO sensitivity setting, the second with sensitivity reduced by the selected amount, and the third with ISO sensitivity increased by the selected amount.

- If shutter speed or aperture have been changed to modify exposure from the value selected by the camera, the camera will vary ISO sensitivity around the current exposure value.
- The maximum sensitivity selected for [ISO-Auto Set] does not apply.
- During silent photography, the flash sync speed is set to 1/20 s.
- Changing the option selected for [ISO Step] (P. 530) in  Custom Menu  does not change the options available for bracketing amount.
- ISO sensitivity bracketing cannot be combined with art filters or focus bracketing.

## **ART BKT (Art Filter Bracketing)**

The camera applies multiple art filters to a single photo. You choose the filter types. The camera takes one picture when the shutter button is pressed all the way down and records multiple copies, each with a different filter applied.

Filters are chosen from a menu where selected filters are marked with a check (✓). In addition to art filters, you can also have the option of selecting picture modes such as [Vivid], [Natural], and [Muted].

- The time needed to record each shot increases with the number of filters selected.
- With the exceptions of exposure and flash bracketing, art filter bracketing cannot be combined with other forms of bracketing.

## Focus BKT (Focus Bracketing)

The camera varies focus over a series of pictures. You choose the amount and the number of shots. The entire series is shot with a single press of the shutter button. Each time the shutter button is pressed all the way down, the camera takes the selected number of shots, varying focus with each shot. The pictures are taken in silent mode using the electronic shutter.

The following options are available:

- [Set number of shots]: Choose the number of shots in the bracketing sequence
- [Set focus differential]: Choose the amount the camera varies focus with each shot
- [⚡ Charge Time]: Choose how long the camera waits for the flash to charge between shots when using a flash unit not specifically designated for use with the camera.

Focus stacking ([Focus Stacking], P. 243) can be used to create a single picture from a series of shots taken using focus bracketing. This option is available only with lenses that support focus stacking. See the Olympus website for information on compatible lenses.

- Once the shutter button has been pressed all the way down, shooting will continue until the selected number of shots has been taken. To interrupt bracketing, press the shutter button all the way down a second time.
- The camera varies the focus distance with each shot. Shooting will end if the focus distance reaches infinity.
- Shooting will end if focus or zoom is adjusted after the shutter button has been pressed all the way down to start bracketing.
- Focus bracketing is not available with Four Thirds system lenses.
- Focus bracketing cannot be combined with other forms of bracketing.
- The flash sync speed is set to 1/50 s. Selecting a value over ISO 8000 for [ISO] sets the flash sync speed to 1/20 s.
- Focus bracketing is not available in mode **B**.

## ■ Access via the BKT Button

Use the **BKT** to choose the bracketing type and adjust settings. Settings for [ART BKT] or [Focus BKT] must be adjusted in the menus beforehand.

- 1 Hold the **BKT** and rotate the front or rear dial a small amount.

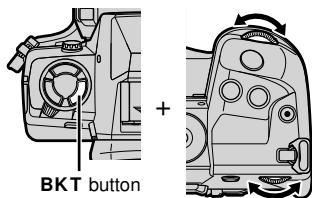

- The camera will list bracketing types and options.
- Bracketing settings can also be displayed by pressing and holding the **BKT** button.

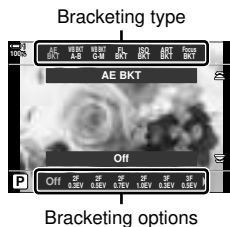

- 2 Rotate the front dial to highlight a bracketing type.
  - 3 Rotate the rear dial to highlight the desired bracketing settings.
- The settings available vary with the bracketing type selected.

<b>AE BKT</b>	Choose the number of shots and the amount exposure changes with each shot.
<b>WB BKT: A-B</b>	Choose the white balance compensation amount.
<b>WB BKT: G-M</b>	
<b>FL BKT</b>	Choose the amount flash level changes with each shot.
<b>ISO BKT</b>	Choose the amount exposure changes with each shot.
<b>ART BKT</b>	Enable or disable art filter or focus bracketing.
<b>Focus BKT</b>	

- 4 Press the **OK** button to select the highlighted options.
- Bracketing settings will clear from the display.
  - You can also exit by pressing the shutter button halfway.

- 5 Press the **BKT** once to enable bracketing.

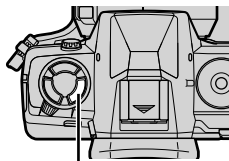

BKT button

- A **BKT** icon will be displayed.
- Bracketing turns on or off each time the **BKT** button is pressed.

BKT icon

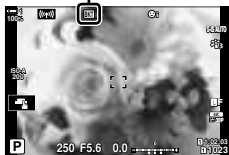

2

- 6 Take pictures.

- During exposure and flash bracketing, the **BKT** icon will be displayed in green until all shots in the sequence have been taken.

## ■ Menu Access

- 1 Press the **MENU** button to display the menus.
- 2 Highlight [Bracketing] in **Shooting Menu 2** and press **▷** on the arrow pad.
- 3 Highlight [On] using the **△ ▽** buttons and press the **▷** button.
  - A menu of bracketing types will be displayed.

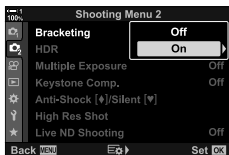
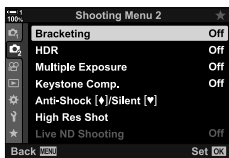

- 4 Highlight a bracketing type using the  $\Delta$   $\nabla$  buttons and press the  $\triangleright$  button.

- The camera will display bracketing options for the selected bracketing type.



- 5 Using the  $\Delta$   $\nabla$   $\triangleleft$   $\triangleright$  buttons, select [On] or a bracketing program.

• **AE BKT**

Highlight the number of shots (for example, 2f) and press the  $\triangleright$  button to view bracketing amounts. Use the  $\Delta$   $\nabla$  buttons to highlight an amount and press **OK** to select the highlighted option and return to the previous display.

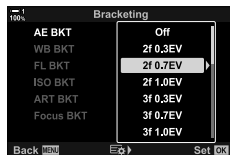

• **WB BKT**

You will be prompted to choose a color axis (A-B or G-M). Use the  $\triangleleft$   $\triangleright$  buttons to highlight an axis and the  $\Delta$   $\nabla$  buttons to choose the bracketing amount. Press the **OK** to return to the previous display when settings are complete.



• **ART BKT**

Highlight [On] and press the  $\triangleright$  button to display a menu of picture modes and art filters. Use the  $\Delta$   $\nabla$  buttons to highlight the desired filters and press the **OK** button to select (selected filters are indicated by check marks). Press the **MENU** button to return to the previous display when settings are complete.

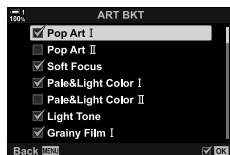

• **Focus BKT**

Highlight [On] and press the  $\triangleright$  button to view focus bracketing settings. Use the  $\Delta$   $\nabla$  buttons to highlight a setting and press the  $\triangleright$  button. Options will be displayed; use the  $\Delta$   $\nabla$  buttons to highlight an option and press the **OK** button to return to the setting menu. Press the **OK** button again to return to the bracketing menu when settings are complete. The [Focus BKT] menu is also used for [Focus Stacking] settings (P. 243).

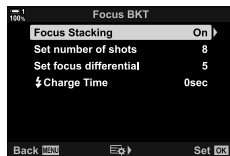

- 6 With [On] selected, press the **OK** button to save changes and exit.

- 7 Confirm that [On] is selected for [Bracketing] and press the **OK** button.

- To save changes without enabling bracketing, press the **MENU** button or highlight [Off] and press the **OK** button.



Combine multiple images for a depth of field greater than can be obtained with a single shot. The camera takes a series of shots at focus distances both in front of and behind the current focus position and creates a single image from the areas that are in focus in each shot.

Choose this option if you want all areas of the subject in focus in photographs taken at short ranges or wide apertures (low f-numbers). The pictures are taken in silent mode using the electronic shutter.

- The composite image is recorded in JPEG format, regardless of the option selected for image quality.
- The composite image is enlarged 7% horizontally and vertically.
- Shooting will end if focus or zoom is adjusted after the shutter button has been pressed all the way down to start focus stacking photography.
- If focus stacking fails, the camera will record the selected number of photos without creating a composite image.
- This option is available only with lenses that support focus stacking. See the Olympus website for information on compatible lenses.
- Pictures taken with [e-Portrait] or an art filter selected for picture mode are recorded in [Natural] mode.
- Focus stacking cannot be combined with other forms of bracketing.

- 1 Press the **MENU** button to display the menus.
- 2 Highlight [Bracketing] in  Shooting Menu 2 and press **▶** on the arrow pad.

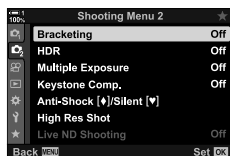

- 3 Highlight [On] using the  $\Delta$   $\nabla$  buttons and press the **▶** button.
  - A menu of bracketing types will be displayed.



- 4 Highlight [Focus BKT] using the  $\Delta$   $\nabla$  buttons and press the **▶** button.
  - You will be prompted to turn focus bracketing on or off.

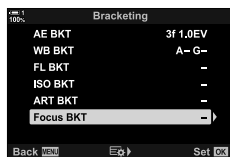

**5** Highlight [On] using the  $\Delta$   $\nabla$  buttons and press the  $\triangleright$  button.

- [Focus BKT] settings will be displayed.



**6** Highlight a setting using the  $\Delta$   $\nabla$  buttons and press the  $\triangleright$  button.

[Focus Stacking]: Highlight [On] and press the **OK** button.

[Set number of shots]: Choose the number of shots. Choose from values of from 3 to 15.

[Set focus differential]: Choose the amount the camera varies focus with each shot and press the **OK** button.

[⚡ Charge Time]: Choose how long the camera waits for the flash to charge between shots when using a flash unit not specifically designated for use with the camera.

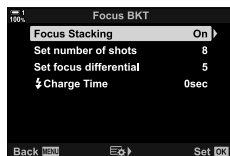

2

**7** Press the **OK** button repeatedly to exit the menus.

- Confirm that bracketing is on and press the **MENU** button.



- A **[BKT]** icon will be displayed.
- Picture mode will be set to [Natural].
- A frame indicating the final crop will be shown in the display. Compose the shot with your subject in the frame.

**[BKT]** icon





**8** Take pictures.

- The camera will automatically take the selected number of shots when the shutter button is pressed all the way down.



## 9 Press the **BKT** button to end bracketing.

- To take more pictures at the same bracketing settings, press the **BKT** button.
- The flash can only be used if [Allow] is selected for [Silent [♥] Mode Settings] (P. 167) > [Flash Mode] in  Shooting Menu 2.
- The flash sync speed is set to 1/50 s. Selecting a value over ISO 8000 for [ ISO] sets the flash sync speed to 1/20 s.



- We recommend using a remote cable to reduce blur caused by camera shake. In anti-shock or silent mode, you can use [Anti-Shock [♦]] (P. 160) or [Silent [♥]] (P. 163) to choose how long the camera will wait to release the shutter after the shutter button is pressed all the way down.

## Overlaying Pictures

## (Multiple Exposure)

Take two shots and combine them into a single picture. Alternatively, you can take a shot and combine it with an existing picture stored on the memory card.

The combined image is recorded at current image quality settings. Only RAW pictures can be selected for multiple exposures that include an existing image. If you record a multiple exposure with RAW selected for [CAMERA], you can then select it for subsequent multiple exposures using [Overlay], allowing you to create multiple exposures combining three or more photographs.

- 1 Press the **MENU** button to display the menus.
- 2 Highlight [Multiple Exposure] in Shooting Menu 2 and press  $\triangleright$  on the arrow pad.

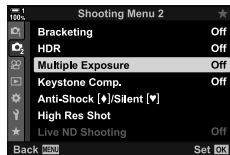

- 3 Highlight a setting using the  $\Delta$   $\nabla$  buttons and press the  $\triangleright$  button.
  - Highlight the desired option and press the **OK** button.

<b>Number of Frames</b>	[Off]: Do not create additional multiple exposures. [2f]: Create a multiple exposure from 2 pictures.
<b>Auto Gain</b>	[On]: Halve the brightness of each picture in the multiple exposure. [Off]: Do not adjust brightness the brightness of the pictures in the multiple exposure.
<b>Overlay</b>	[On]: Shoot a multiple exposure that includes an existing RAW image stored on the memory card. [Off]: Create a multiple exposure from the next 2 pictures taken. <ul style="list-style-type: none"><li>• [Overlay] is only available when [2f] is selected for [Number of Frames].</li></ul>

- 4 If [On] is selected for [Overlay], you will be prompted to choose a picture for the multiple exposure.
  - Highlight a picture using the arrow pad ( $\Delta$   $\nabla$   $\triangleleft$   $\triangleright$ ) and press the **OK** button.
  - Only RAW images can be selected.

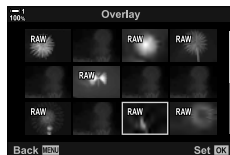



- 5 Press the **OK** button in the multiple exposure menu to save the selected settings.
  - The shooting menu will be displayed.

## 6 Press the **MENU** button to exit the menus.

- A  icon will be displayed.
- If [Overlay] is selected, the chosen photograph will be visible superimposed on the view through the lens.



## 7 Take pictures.

- The first shot (or if [Overlay] is selected, the previously-chosen photograph) will be visible superimposed on the view through the lens as you compose the next shot.
- The  icon turns green.
- Normally, a multiple exposure will be created after the second shot is taken.
- Pressing the  button allows you to retake the first shot.
- If [On] is selected for [Overlay], you can take additional pictures that will be overlaid on the previously-chosen photograph.



## 8 Press the **MENU** button or press the **▶** button to end multiple exposure photography.

- If you end multiple exposure photography by pressing the **MENU** button, [Off] will be selected for [Number of Frames] in the multiple exposure menu.
- The  icon clears from the display when multiple exposure photography ends.



- The camera will not enter sleep mode during multiple exposure photography.
- Pictures taken with other cameras cannot be used for multiple exposures.
- RAW pictures taken using High Res Shot cannot be used for multiple exposures.
- The RAW pictures listed in the image-selection display when [On] is selected for [Overlay] are those processed using the settings in effect at the time the photograph was taken.
- Exit multiple exposure mode before adjusting shooting settings. Some settings cannot be adjusted while multiple exposure mode is in effect.
- Performing any of the following operations after the first shot is taken ends multiple exposure photography:
  - turning the camera off, pressing the **▶** or **MENU** button, choosing a different shooting mode, or connecting cables of any type. Multiple exposure is also canceled when the battery is exhausted.
- The image-selection display for [Overlay] shows the JPEG copies of photographs taken with RAW + JPEG selected for image quality.
- Live composite photography ([LIVE COMP]) is not available in mode **B**.
- The following are not available in multiple exposure mode:
  - HDR, bracketing, interval-timer photography, keystone compensation, the live ND filter, and fisheye correction.
- Pictures taken with RAW selected for  can also be overlaid during playback.

# Keystone Effects/Enhancing Perspective (Keystone Comp.)

Keystone distortion due to the influence of lens focal length and proximity to the subject can be corrected, or enhanced to exaggerate the effects of perspective. Keystone compensation can be previewed in the monitor during shooting. The corrected image is created from a smaller crop, slightly increasing the effective zoom ratio.

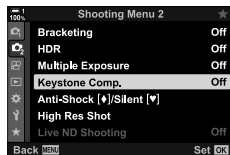



- 1 Press the **MENU** button to display the menus.
- 2 Highlight [Keystone Comp.] in  Shooting Menu 2 and press  on the arrow pad.

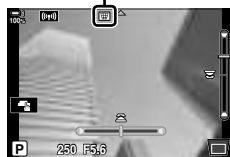

- 3 Highlight [On] using the   buttons and press the **OK** button.
- 4 Press the **MENU** button to exit the menus.
  - The camera will switch to the keystone compensation display. A slider and  icon be displayed.

Keystone compensation







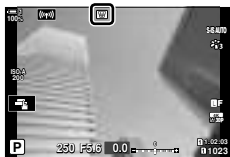

- 5 Frame the shot and adjust keystone compensation while viewing your subject in the display.
  - Rotate the front dial to make horizontal adjustments and the rear dial to make vertical adjustments.
  - Frame the shot and adjust keystone compensation while viewing your subject in the display.
  - Use the arrow pad (   ) to position the crop. The direction in which the crop can be moved is shown by an arrow ().
  - To cancel changes, press and hold the **OK** button.



- 6** To adjust aperture, shutter speed, and other shooting settings, press the **INFO** button.
- Standard shooting indicators will be displayed.
  - A  icon is displayed while keystone compensation is enabled. The icon is displayed in green if adjustments have been made to keystone compensation settings.
  - To return to the keystone compensation display shown in Step 5, press the **INFO** button repeatedly.



## 7 Take pictures.

- To end keystone compensation photography, select [Off] for [Keystone Comp.] in  Shooting Menu 2.
- Pictures may seem “grainy” depending on the amount of compensation performed. The amount of compensation also determines the amount the picture will be enlarged when cropped and whether the crop can be moved.
- Depending on the amount of compensation, you may be unable to reposition the crop.
- Depending on the amount of compensation performed, the selected AF target may not be visible in the display. If the AF target is outside the frame, its direction is indicated by a , , , or  icon in the display.
- Pictures taken with [RAW] for image quality are recorded in RAW + JPEG format.
- The following cannot be used:
  - live composite photography, burst photography, bracketing, HDR, multiple exposure, the live ND filter, fisheye correction, the digital teleconverter, movie recording, [C-AF], [C-AF MF], [C-AF+TR], and [C-AF+TR MF] AF modes, [e-Portrait] and art filter picture modes, the custom self-timer, and High Res Shot.
- Lens converters may not produce the desired results.
- Keystone compensation for lenses for which the focal length or lens data have been saved using  [Image Stabilizer] is performed in accord with the data provided. Be sure to provide  [Image Stabilizer] data for lenses that are not part of the Four Thirds or Micro Four Thirds family (P. 510).





- [Keystone Comp.] can be assigned to a button. You then need only press the button to enable keystone compensation.   Custom Menu **B1** >  Button Function (P. 463)

# Correcting Fisheye Distortion (Fisheye Compensation)

Correct distortion caused by fisheye lenses to give photos the appearance of pictures taken with a wide-angle lens. The amount of correction can be selected from three different levels. You can also opt simultaneously to correct distortion in photos taken under water.

- This option is only available with compatible fisheye lenses.

As of January 2019, it could be used with the M.ZUIKO DIGITAL ED 8mm f1.8 Fisheye PRO.

<b>Angle</b>	When fisheye correction is performed, the picture is cropped to eliminate blacked-out areas. Choose from three different crops.
  <b>Correction</b>	Choose whether to correct distortion in photos taken under water in addition to the correction performed using [Angle].

**1** Press the **MENU** button to display the menus.

**2** Display  Custom Menu  (Utility).



**3** Highlight [Fisheye Compensation] using  $\Delta$   $\nabla$  on the arrow pad and press the  $\triangleright$  button.



**4** Highlight [On] using the  $\Delta$   $\nabla$  buttons and press the  $\triangleright$  button.

- [Angle] and  Correction] will be displayed.



**5** Highlight an item using the  $\Delta$   $\nabla$  buttons and press the  $\triangleright$  button.

- Highlight an option using the  $\Delta$   $\nabla$  buttons and press the **OK** button.
- If you are not taking photos under water, choose [Off] for  Correction].
- [Fisheye Compensation] options will be displayed



## 6 Press the **OK** button repeatedly to exit to the custom menu.

- After confirming that [On] is selected for [Fisheye Compensation], press the **MENU** button to exit the menus.
- When fisheye compensation is enabled, a  icon will be displayed together with the selected crop.



Fisheye compensation



## 7 Take pictures.

- To end fisheye compensation, select [Off] for [Fisheye Compensation] in  Custom Menu **B1**.
- Pictures taken with [RAW] selected for image quality are recorded in RAW + JPEG format. Fisheye compensation is not applied to the RAW image.
- Focus peaking is not available in the fisheye compensation display.
- AF-target selection is restricted to single- and small-target modes.
- The following cannot be used:
  - live composite photography, burst photography, bracketing, HDR, multiple exposure, the live ND filter, keystone compensation, the digital teleconverter, movie recording, [C-AF], [C-AF **MF**], [C-AF+TR], and [C-AF+TR **MF**] AF modes, [e-Portrait] and art filter picture modes, the custom self-timer, and High Res Shot.



- [Fisheye Compensation] can be assigned to a button. You then need only press the button to enable fisheye correction.   Custom Menu **B1** >  Button Function] (P. 463)

## 2-15 Flash Photography

When using an optional flash unit designed for use with the camera, you can choose the flash mode using camera controls and take pictures with the flash. See the documentation provided with the flash unit for information on flash features and their use.

2

### Compatible Flash Units

Choose a flash unit to suit your needs, taking into consideration such factors as the output required and whether the unit supports macro photography. Flash units designed to communicate with the camera support a variety of flash modes, including TTL auto and super FP. Flash units can be mounted on the camera hot shoe or connected using a cable (available separately) and flash bracket. The camera also supports the following wireless flash control systems:

#### **Radio-Controlled Flash Photography: CMD, CMD, RCV, and X-RCV Modes**

The camera controls one or more remote flash units by means of radio signals. The range of locations in which flash units can be placed increases. Flash units can control other compatible units or be fitted with radio commander/receivers to allow the use of units that do not otherwise support radio flash control.

#### **Wireless Remote-Control Flash Photography: RC Mode**

The camera controls one or more remote flash units by means of optical signals. The flash mode can be selected using camera controls (P. 254).



## ■ Features Available with Compatible Flash Units













Flash unit	Supported flash control modes	GN (Guide Number, ISO 100)	Supported wireless systems
<b>FL-700WR</b>	TTL-AUTO, MANUAL, FP TTL AUTO, FP MANUAL, MULTI, RC, SL MANUAL	GN 42 (150 mm <sup>*1</sup> ) GN 21 (24 mm <sup>*1</sup> )	CMD, ⚡CMD, RCV, X-RCV, RC
<b>FL-900R</b>	TTL-AUTO, AUTO, MANUAL, FP TTL AUTO, FP MANUAL, MULTI, RC, SL AUTO, SL MANUAL	GN 58 (200 mm <sup>*1</sup> ) GN 27 (24 mm <sup>*1</sup> )	RC
<b>FL-600R</b>		GN 36 (85 mm <sup>*1</sup> ) GN 20 (24 mm <sup>*1</sup> )	RC
<b>STF-8</b>	TTL-AUTO, MANUAL, RC <sup>*2</sup>	GN 8.5	RC <sup>*2</sup>
<b>FL-LM3</b>	Varies with camera settings.	GN 9.1 (24 mm <sup>*1</sup> )	RC <sup>*2</sup>

\*1 Maximum lens focal length (35 mm format equivalent) at which unit can provide flash coverage.

\*2 Functions as commander (transmitter) only.

When taking pictures with a flash unit designed for use with the camera, you can select a flash mode using camera controls. Turning an attached flash unit on automatically limits the fastest available shutter speed.

## ■ Flash Modes

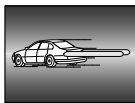

 <b>Fill In</b>	Enable the flash. <ul style="list-style-type: none"> <li>Shutter speed can be set to values between that selected for [⚡ Slow Limit] (P. 261) and [⚡ X-Sync.] (P. 260) in  Custom Menu .</li> </ul>
 <b>Flash Off</b>	Disable the flash. <ul style="list-style-type: none"> <li>The flash will not fire even if the unit is on.</li> </ul>
 <b>Redeye</b>	Reduce “red-eye” in portrait photos. In other respects, the flash functions as it does in  (fill in) mode.
 <b>Slow</b> (slow front-curtain sync)	Slow shutter speeds are used to capture both the main subject and the background. <ul style="list-style-type: none"> <li>Shutter speed is set according to the exposure value metered by the camera and is not restricted by the option selected for [⚡ Slow Limit].</li> </ul>
 <b>Red-Eye Slow</b>	 (slow sync) combined with red-eye reduction. The flash is timed using front-curtain sync.
 <b>Slow2</b> (slow rear-curtain sync)	As for  (slow sync). <ul style="list-style-type: none"> <li>The flash fires immediately before the shutter closes. Moving objects appear to leave trails of light behind them.</li> </ul>
 FULL,  1/4, etc. <b>Manual Value</b>	The flash fires at the selected level. <ul style="list-style-type: none"> <li>The flash level is selected manually (P. 257).</li> </ul>

















- Super FP high-speed sync must be configured using flash controls.
- In [⚡] (red-eye reduction) mode, the shutter is released approximately one second after the first red-eye reduction flash. Do not move the camera until shooting is complete.
- [⚡] (red-eye reduction) may not produce the desired results in some conditions.



## ■ Flash Mode and Shutter Speed

The range of shutter speeds available varies with the flash mode. The range of available speeds can be further restricted using the options in the  custom menu.

 [X-Sync.] (P. 260), [ Slow Limit] (P. 261)

Exposure mode	LV super control panel	Flash mode	Flash timing	Shutter speed
P/A		Fill flash	Front-curtain sync	30–1/250 s
		Red-eye		
		Flash off	—	—
		Red-eye slow	Front-curtain sync	60–1/250 s
		Slow front-curtain sync		
		Slow rear-curtain sync	Rear-curtain sync	
S/M		Fill flash	Front-curtain sync	60–1/250 s
		Red-eye		
		Flash off	—	—
		Slow rear-curtain sync	Rear-curtain sync	60–1/250 s
B*		Fill flash	Front-curtain sync	—
		Red-eye		
		Flash off	—	—
		Slow rear-curtain sync	Rear-curtain sync	—

\* Rear-curtain sync is not available when [LIVE COMP] is selected (P. 108).

- The fastest shutter speed available when the flash fires is 1/250 s. Bright backgrounds in pictures taken with the flash may be overexposed.
- The flash sync speed for silent modes (P. 163), tripod-mounted High Res Shot (P. 210), and focus bracketing (P. 239) is 1/50 s. Setting [ ISO] to a value over ISO 8000 when using an option that requires the electronic shutter (for example, silent mode or focus bracketing) sets the flash sync speed to 1/20 s. The flash sync speed is also set to 1/20 s during ISO bracketing (P. 238).
- Even the minimum available flash output may be too bright at short range. To prevent overexposure in pictures taken at short range, select mode **A** or **M** and choose a smaller aperture (higher f-number) or choose a lower setting for [ ISO].
- There is no limit on the fastest shutter speed available when an FP mode (FP TTL AUTO or FP MANUAL) is selected using flash controls.

## ■ Attaching Compatible Flash Units

The methods used to attach and operate external flash units vary with the unit. See the documentation provided with the unit for details. The instructions here apply to the FL-LM3.

- Confirm that both the camera and flash unit are off. Attaching or removing a flash unit while either the camera or flash unit is on could damage the equipment.

### 1 Remove the hot shoe cover and attach the flash.

- Slide the flash in until the foot clicks into place at the back of the shoe.

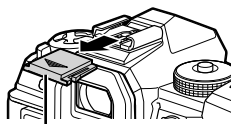

Hot shoe cover

2

### 2 Position the flash head for bounce-flash photography or direct lighting.

- The flash head can be rotated up and left or right.
- Note that flash output may be insufficient for correct exposure when bounce flash lighting is used.

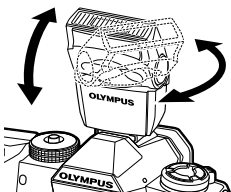

### 3 Rotate the flash **ON/OFF** lever to the **ON** position.

- Rotate the lever to the **OFF** position when the flash is not in use.

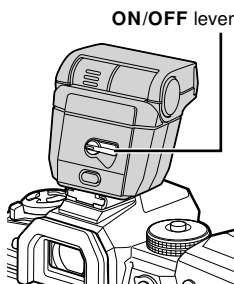

## ■ Removing Flash Units

- 1 Keeping the **UNLOCK** button pressed, slide the flash unit from the hot shoe.

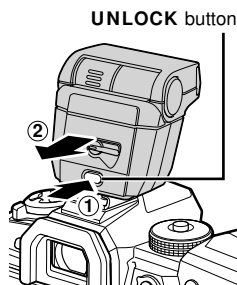

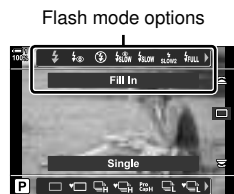

## ■ Accessing Flash Settings via the (Flash/Sequential Shooting/Self-timer) Button

- 1 Press the  button.
  - Flash mode options will be displayed.



- 2 Rotate the front dial to highlight an option.
- 3 If manual flash control is selected, press the **INFO** button.
  - Rotate the front dial to highlight the desired flash output.
- 4 Press the **OK** button to select the highlighted option and exit to the shooting display.

## ■ Access via the LV Super Control Panel

Flash settings can be accessed via the LV super control panel. If [ Manual] (manual mode) is highlighted, press  to select [ FULL]. Rotate the front dial to choose the desired flash output.

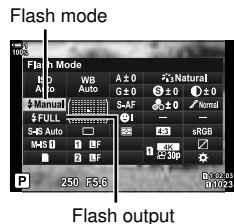

## ■ Access via Live Controls

Flash settings can be accessed via live controls.

- For information on displaying live controls, see “Using Live Controls” (P. 68).



 Flash Mode

OK button ➔ [ Flash Mode] ➔ Press <D> on the arrow pad to choose an option

- To choose a level for manual flash output, highlight  FULL (Full) and press the **INFO** button.

## Adjusting Flash Output



Adjust flash output. Use this option to adjust flash level if the flash is too bright even in auto mode or if the value selected by the camera leaves your subject underexposed.

Flash compensation is available in modes other than [⚡ Manual] (manual).

- 1 Highlight [⚡] in the LV super control panel.

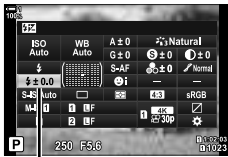

Flash compensation

- 2 Highlight an option using the front dial.
  - 3 Press the shutter button halfway to select the highlighted option and exit the LV super control panel.
- The flash compensation value selected with the camera is added to that selected with compatible flash units.

## Choosing a Flash Sync Speed



Choose the fastest shutter speed available for flash photography.

Shutter speeds faster than the chosen value cannot be selected even when the subject is brightly lit.

**Available options** 1/60–1/250 s

**1** Press the **MENU** button to display the menus.

**2** Display Custom Menu **F** ( Custom).



**3** Highlight [ X-Sync.] using  $\Delta$   $\nabla$  on the arrow pad and press the  $\triangleright$  button.



**4** Highlight an option using the  $\Delta$   $\nabla$  buttons and press the **OK** button.

**5** Press the **MENU** button repeatedly to exit the menus.

- The flash sync speed for silent modes (P. 163), High Res Shot (P. 210), and focus bracketing (P. 239) is 1/50 s. The flash sync speed drops to 1/20 s at [ ISO] values over ISO 8000 or when ISO bracketing (P. 238) is enabled.



## Setting a Slow Shutter Speed Limit (⚡ Slow Limit)

Choose the slowest shutter speed available for flash photography.

The shutter speed chosen automatically by the camera will not exceed this value even when the subject is poorly lit. This limit does not apply in slow sync flash modes (⚡SLOW, SLOW2, or ⚡SLOW).

### Available options

Values from 30 s to up to but not including the limit selected for [⚡X-Sync.]

- 1 Press the **MENU** button to display the menus.
- 2 Display **⚡ Custom Menu** **F** (⚡ Custom).
- 3 Highlight [**⚡ Slow Limit**] using **Δ**/**∇** on the arrow pad and press the **▶** button.
- 4 Highlight an option using the **Δ**/**∇** buttons and press the **OK** button.
- 5 Press the **MENU** button repeatedly to exit the menus.

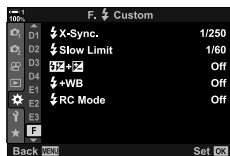

2

## Wireless Remote Flash Control

Wireless flash photography is available with compatible flash units that support wireless remote control (RC). The remote flash units are controlled via a unit mounted on the camera hot shoe. Settings can be adjusted separately for the camera-mounted unit and units in up to three other groups.

RC mode must be enabled on both the master and remote flash units.

### ■ Enabling RC Mode

1 Press the **MENU** button to display the menus.

2 Display **Custom Menu F** (⚡ Custom).

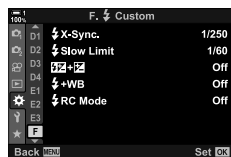

3 Highlight [⚡ RC Mode] using  $\Delta$   $\nabla$  on the arrow pad and press the  $\triangleright$  button.

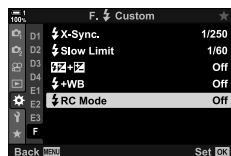

4 Highlight [On] using the  $\Delta$   $\nabla$  buttons and press the **OK** button.

- The camera will exit to the shooting display.
- An **RC** icon will be displayed.



5 Press the **OK** button.

- The RC mode super control panel will be displayed.
- The standard LV super control panel can be displayed by pressing the **INFO** button. The display will change each time the **INFO** button is pressed.



RC mode super control panel

- 6** Adjust flash settings.
- Highlight items using the  $\Delta$   $\nabla$   $\triangleleft$   $\triangleright$  buttons and rotate the rear dial to choose settings.

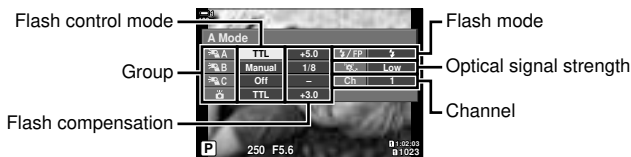

<b>Group</b>	Choose a group. Changes to settings apply to all units in the selected group. Choose  to adjust settings for the unit mounted on the camera.
<b>Flash control mode</b>	Choose a flash mode.
<b>Flash compensation</b>	Adjust flash output. When [Manual] is selected for flash mode, you can a value for manual flash output.
<b>Optical signal strength</b>	Choose the brightness of the optical control signals emitted by the flash units. Choose [HI] if you have placed flash units at close to the maximum distance from the camera. This setting applies to all groups.
<b>Flash mode/ flash level</b>	Choose  (standard) or FP (super FP). Choose super FP for shutter speeds faster than the flash sync speed. This setting applies to all groups.
<b>Channel</b>	Choose the channel used for flash control. Change the channel if you find that other light sources in the area are interfering with remote flash control.

2

- 7** Set the unit mounted on the camera to [TTL AUTO].
- Flash control settings for the FL-LM3 can only be adjusted using the camera.

## ■ Positioning Remote Flash Units

- Set the wireless RC flash units to RC mode.
  - After turning compatible flash units on, press the **MODE** button and choose RC mode.
  - Choose a group for each of the compatible flash units using flash controls and match the channel to that selected with the camera.
- Position the flash units.
  - Position the wireless units with the remote sensors facing the camera.
- Take pictures after confirming that the remote units and the unit on the camera are charged.

## ■ Wireless Flash Control Range

The illustration is intended as a guide only. The flash control range varies with the type of flash mounted on the camera and the conditions in the surrounding area.

### Flash Control Range for Camera-Mounted FL-LM3 Flash Units

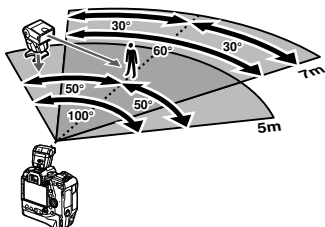

- We recommend that each group contain no more than 3 flash units.
- Wireless flash photography is not available in anti-shock mode or in rear-curtain slow sync mode when a shutter speed slower than 4 s is selected.
- Start wait times longer than 4 s cannot be selected in anti-shock and silent modes.
- Flash control signals may interfere with exposure if subject is too close to the camera. This can be mitigated by reducing the brightness of the camera flash, for example by using a diffuser.

## Third-Party Flash Units

Third-party flash units can be mounted on the hot shoe or connected via a sync cable. Be sure to replace the cap on the external flash connector when it is not in use. Observe the following precautions when mounting a third-party flash unit on the hot shoe:

- The camera X contacts (hot shoe and external flash connector) are not polarized. Note, however, that older flash units requiring voltages over about 250 V must not be used, as they could damage the connectors.
- Attaching flash units with connectors that do not conform to Olympus specifications could cause product malfunction.
- When using a third-party flash unit, select shooting mode **M**, choose a shutter speed no faster than the flash sync speed, and choose a setting other than [AUTO] for [ISO].
- When adjusting flash output using flash controls, you will need to supply the flash with information on the ISO sensitivity and aperture selected with the camera. Be sure to set ISO sensitivity or aperture appropriately when adjusting flash output.
- Use a flash that covers the angle of the lens. Be aware that coverage is typically stated using 35 mm format equivalent focal lengths.

## 2-16 Working with Saved Images

Pictures are saved to the memory card and can be viewed in the camera monitor. You can rotate or delete pictures or retouch them using many of the same functions used when they were recorded. You can also quickly select pictures for later upload to a smartphone.

### Choosing the Information Displayed

Choose the information displayed during playback.

- 1 Press the  button.
  - The most recent picture will be displayed.



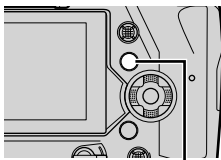

- 2 Press the **INFO** button.
  - The information displayed changes each time the button is pressed.

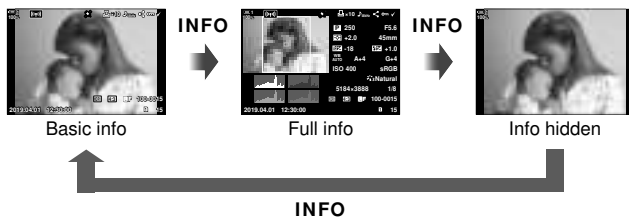

INFO button



- You can also hold the **INFO** button and rotate the front or rear dial to choose the information displayed.
- You can add histogram, highlight and shadow, light box, and field sensor info items to the playback information display. Use  Custom Menu **D1** >  Info Settings] (P. 515) >  Info] to choose items displayed.

# The Playback Info Display

## Basic Info



## Full Info

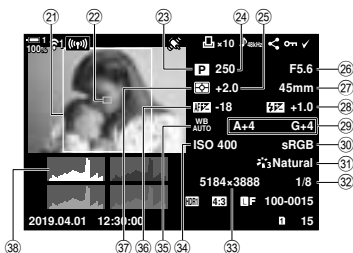

- ① Battery level ..... P. 44
- ② Wireless LAN connection status ..... P. 584, 600
- ③ Active **Bluetooth**® connection ..... P. 586
- ④ Active connection to computer ..... P. 600
- ⑤ Wireless LAN connection ..... P. 592, 596, 597
- ⑥ GPS data indicator ..... P. 570
- ⑦ “Print” icon  
Number of prints ..... P. 291
- ⑧ Audio indicator ..... P. 281
- ⑨ “Share” icon ..... P. 277
- ⑩ “Protected” icon ..... P. 270
- ⑪ “Selected” icon ..... P. 279
- ⑫ File number ..... P. 548
- ⑬ Frame number
- ⑭ Playback slot ..... P. 57
- ⑮ Image quality ..... P. 78
- ⑯ Aspect ratio ..... P. 233
- ⑰ HDR ..... P. 195
- ⑱ Composite picture created using focus stacking ..... P. 243

- ⑲ Live ND filter ..... P. 197
- ⑳ Date and time ..... P. 455
- ㉑ Aspect frame ..... P. 233
- ㉒ AF target display ..... P. 53, 123
- ㉓ Shooting mode ..... P. 93–113
- ㉔ Shutter speed ..... P. 94–102
- ㉕ Exposure compensation ..... P. 180
- ㉖ Aperture ..... P. 94–102
- ㉗ Focal length ..... P. 39
- ㉘ Flash compensation ..... P. 259
- ㉙ White balance fine-tuning ..... P. 206
- ㉚ Color space ..... P. 232
- ㉛ Picture mode ..... P. 215
- ㉜ Compression ratio ..... P. 81
- ㉝ Image size (in pixels) ..... P. 82
- ㉞ ISO sensitivity ..... P. 181
- ㉟ White balance ..... P. 202
- ㊱ AF fine-tuning ..... P. 492
- ㊲ Metering ..... P. 186
- ㊳ Histogram ..... P. 84





\* The field sensor info display contains the following indicators. [Info Settings] (P. 515)

Latitude/longitude, heading, temperature, altitude, and barometric pressure

You can zoom in on pictures during playback. Use zoom to examine photos in the monitor. You can scroll the picture to view areas not currently visible in the display.

- 1 Press the  button.
  - The most recent picture will be displayed.







- 2 Rotate the rear dial to .
  - The camera will zoom in on the current picture (playback zoom).
  - Use the multi selector to scroll the image. You can also use the arrow pad (   ).





Playback zoom



2

- You can choose a memory card for playback by:
  - Pressing the **CARD** button and then rotating the front or rear dial
  - Holding the  button and rotating the front or rear dial

This does not change the option selected for [Card Slot Settings] (P. 547) > [ Slot] in  Custom Menu .

## Using the Zoom Frame

You can also press the multi selector and use the zoom frame to zoom in on a selected area. The zoom frame can also be displayed by pressing the control to which [] (magnify) or [Multi Fn] has been assigned using [ Button Function].

 [ Button Function] (P. 463)

- Touch controls can be used for zoom via the zoom frame.  "Taking Photos with Touch Controls" (P. 54)

# Finding Pictures Quickly (Index and Calendar Playback)

“Index playback” lists the pictures on the memory card as small “thumbnail” images so that you can view multiple pictures at once. This makes it easier to find the picture you want. You can also switch to a calendar display and search for pictures by date of recording.

- 1 Press the  button.
  - The most recent picture will be displayed.









- 2 Rotate the rear dial to .
  - Thumbnails will be displayed.
  - Highlight a picture using the multi selector and then press the multi selector to view the highlighted picture full frame.
  - You can also use the front dial or the arrow pad ( $\Delta \nabla \triangleleft \triangleright$ ).



Index playback



- 3 Without leaving the index display, rotate the rear dial to  again.

- Calendar playback will start. The number of thumbnails in the index display can be chosen using [/Info Settings] (P. 515) > [ Settings] in  Custom Menu **D1**. If more than one type of display is selected, you may have to rotate the rear dial to  more than once to start calendar playback.
- Highlight a date using the front dial or arrow pad and press the **OK** button. The first picture recorded on the selected date will be displayed.
- Rotate the rear dial to  or  to cycle between full-frame, index, and calendar playback.



Calendar playback

- You can choose a memory card for playback by:
  - Pressing the **CARD** button and then rotating the front or rear dial
  - Holding the  button and rotating the front or rear dial

This does not change the option selected for [Card Slot Settings] (P. 547) > [ Slot] in  Custom Menu **H1**.



Rotate pictures for display. Use this option to view pictures taken in portrait (“tall”) orientation without rotating the camera.

- 1 Press the  button.
  - The most recent picture will be displayed.



- 2 Press the **OK** button.
  - A menu of edit options will be displayed.

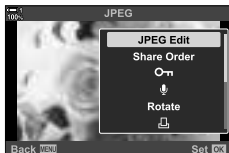

- 3 Highlight [Rotate] using  $\Delta$   $\nabla$  on the arrow pad and press the **OK** button.

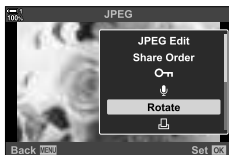



- 4 Press the  $\Delta$  button to rotate the picture counterclockwise, the  $\nabla$  button to rotate it clockwise.
  - You can also rotate pictures by pressing the rear dial.



- 5 Press the **OK** button to save changes and exit.
  - The picture will be saved to the memory card in the selected orientation.
  - Protected images cannot be rotated.



- The camera can be configured to automatically rotate portrait-orientation pictures during playback.  playback menu > [] (P. 283)  
[Rotate] is not available when [Off] is selected for [].

2

Protect pictures from accidental deletion. Protected pictures cannot be deleted using options that delete multiple pictures, but they will be deleted if the memory card is formatted.

- This setting can be accessed via:
  - The  button
  - The menu (P. 271)

## ■ Access via the (protect) Button

1 Press the  button.





- The most recent picture will be displayed.

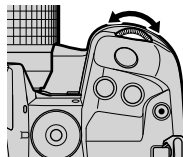

2 Rotate the front dial to display a picture you want to protect.



3 Press the  button.

- A  ("protected") icon will be displayed.
- Press the  button again to remove protection.
- When an unprotected image is displayed, you can hold the  button and rotate the front or rear dial to protect all images displayed while the dial is rotated. Any previously-protected images displayed while the dial is rotated will be unaffected.
- When a protected image is displayed, you can hold the  button and rotate the front or rear dial to remove protection from all images displayed while the dial is rotated. Any previously-unprotected images displayed while the dial is rotated will be unaffected.
- The same operations can be performed during playback zoom or when a picture is selected in the index display.

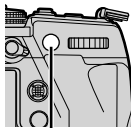

 button

"Protected" icon



## ■ Menu Access

Display a picture and press the **OK** button to view options.

**OK** button → [On] → **OK** button → Press  $\Delta$  or  $\nabla$  on the arrow pad once to protect, again to remove protection → Press the **OK** button to save changes and exit

## Removing Protection from All Pictures (Reset Protect)

Remove protection from all existing pictures on the memory card in the current slot. Use this option if you have protected multiple pictures and want to remove protection from all images at once.

- 1 Press the **MENU** button to display the menus.
- 2 Highlight [Reset Protect] in the  playback menu and press  $\triangleright$  on the arrow pad.
- 3 Highlight [Yes] using the  $\Delta$   $\nabla$  buttons and press the **OK** button.
- 4 Press the **MENU** button repeatedly to exit the menus.



2



This operation can also be applied to multiple selected pictures.  "Selecting Multiple Pictures (On/Copy Select/Erase Selected/Share Order Selected)" (P. 279)

To copy a picture from one memory card to the other when two memory cards are inserted:

- 1 Press the  button.
  - The most recent picture will be displayed.
  
- 2 Rotate the front dial to display a picture you want to copy.
  - To copy a picture from the other card, change to the other slot.
  
- 3 Press the **OK** button.
  - A menu of edit options will be displayed.
  
- 4 Highlight [Copy] using  $\Delta$   $\nabla$  on the arrow pad and press the **OK** button.
  - [Assign Folder to Copy to] options will be displayed.
  
- 5 To choose whether the picture is copied to a selected folder, highlight one of the following options and press the **OK** button.
 

[Assign]: Copy the picture to a new folder or to a selected existing folder. Proceed to Step 6.

[Do not assign]: Copy the picture to the current folder on the destination memory card.

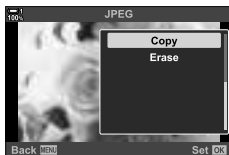
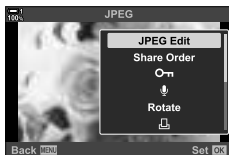
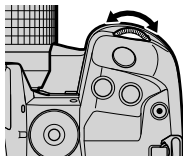

**6** If you selected [Assign] in Step 5, choose the destination folder.

- Highlight [New Folder] or [Existing Folder] using the  $\Delta$   $\nabla$  buttons and press the **OK** button.  
[New Folder]: Choose the desired folder number using the  $\Delta$   $\nabla$  buttons and press the **OK** button.  
[Existing Folder]: Highlight an existing folder using the  $\Delta$   $\nabla$  buttons and press the **OK** button.
- If the chosen folder is unavailable, the camera will return to the previous display; repeat the process as required.



**7** Highlight [Yes] using the  $\Delta$   $\nabla$  buttons and press the **OK** button.





This operation can also be applied to multiple selected pictures.  "Selecting Multiple Pictures (**OK**/Copy Select/Erase Selected/Share Order Selected)" (P. 279)

## Copying All Pictures



(Copy All)

When two memory cards are inserted, you can copy all pictures from one card to the other in a single operation.

<b>1</b> → <b>2</b>	Copy all pictures from the memory card in Slot 1 to the card in Slot 2.
<b>2</b> → <b>1</b>	Copy all pictures from the memory card in Slot 2 to the card in Slot 1.

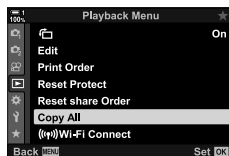

- 1 Press the **MENU** button to display the menus.
- 2 Highlight [Copy All] in the  playback menu and press  on the arrow pad.

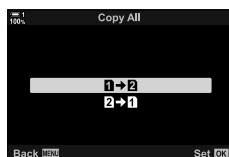

- 3 Highlight [**1**→**2**] or [**2**→**1**] using the   buttons and press the **OK** button.

2



- 4 Highlight [Yes] using the   buttons and press the **OK** button.
  - Copying will start. The playback menu will be displayed when copying is complete.
  - To end the operation before all pictures have been copied, press the **MENU** button.

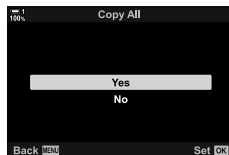

- Copying ends when the destination card is full.
- Depending on the number of pictures and the type of memory card, copying may take some time.

Delete pictures from the memory card one at a time.

- Pictures can be deleted via:
  - The  button
  - The menus

## ■ Deleting Pictures via the Button

- 1 Press the  button.
  - The most recent picture will be displayed.



- 2 Rotate the front dial to display a picture you want to delete.
  - To delete a picture from the other card, change to the other slot.

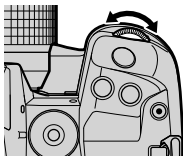

- 3 Press the  button.
  - A confirmation dialog will be displayed.

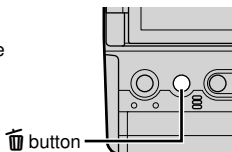









- 4 Highlight [Yes] using  $\Delta$   $\nabla$  on the arrow pad and press the **OK** button.

## ■ Deleting Pictures via the Menus

Display a picture and press the **OK** button to view options.

**OK** button  $\Rightarrow$  [Erase]  $\Rightarrow$  **OK** button  $\Rightarrow$  Highlight [Yes] using  $\Delta$   $\nabla$  on the arrow pad and press the **OK** button to select the highlighted option



- You can opt to skip the confirmation dialog when deleting images.   Custom Menu   $\Rightarrow$  [Quick Erase] (P. 551)
- In the case of pictures recorded with RAW + JPEG selected for image quality, the camera can be configured to delete only the JPEG copy, only the RAW copy, or both the RAW and JPEG copies.   Custom Menu   $\Rightarrow$  [RAW+JPEG Erase] (P. 551)
- This operation can also be applied to multiple selected pictures.  "Selecting Multiple Pictures (/Copy Select/Erase Selected/Share Order Selected)" (P. 279)

Delete all pictures from the memory card. Protected pictures will not be deleted.

- 1 Press the **MENU** button to display the menus.
- 2 Highlight [Card Setup] in the  $\updownarrow$  setup menu and press  $\triangleright$  on the arrow pad.
  - If memory cards are inserted in both slots, you will be prompted to choose a slot. Select Slot 1 or Slot 2 and press the **OK** button.

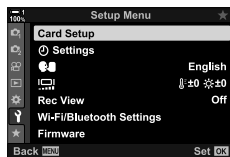

- 3 Highlight [All Erase] using the  $\Delta \nabla$  buttons and press the **OK** button.
  - If there are no pictures on the card in the selected slot, the only option displayed will be [Format]. Choose a different slot.

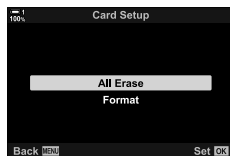

- 4 Highlight [Yes] using the  $\Delta \nabla$  buttons and press the **OK** button.
  - The camera will begin the process of deleting all pictures on the card in the selected slot.
  - The camera will return to the shooting display when deletion is complete.





Smartphones running the OI.Share smartphone app can download pictures from the camera. Pictures marked for download on the camera can be downloaded automatically when the camera is off.

For information on establishing a connection between the camera and smartphone, see “6-2 Connecting to Smartphones via Wi-Fi” (P. 584).

- This setting can be accessed via:
  - The  button
  - The menu (P. 278)

## ■ Access via the (Share) Button





- 1 Press the  button.
  - The most recent picture will be displayed.

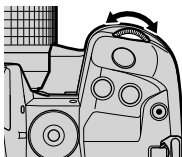

2

- 2 Rotate the front dial to display a picture you want to share.
  - To select a picture on the other card, change to the other slot.



- 3 Press the  button.
  - A  (“share”) icon will be displayed.
  - Press the  button again to remove share marking.
  - When an unmarked image is displayed, you can hold the  button and rotate the front or rear dial to mark for sharing all images displayed while the dial is rotated. Any previously-marked images displayed while the dial is rotated will be unaffected.

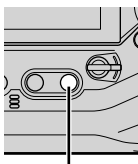

 button

“Share” icon



- When a marked image is displayed, you can hold the  button and rotate the front or rear dial to remove share marking from all images displayed while the dial is rotated. Any previously-unmarked images displayed while the dial is rotated will be unaffected.
- The same operations can be performed during playback zoom or when a picture is selected in the index display.

## ■ Menu Access

Display a picture and press the **OK** button to view options.

**OK** button → [Share Order] → **OK** button → Press  $\Delta$  or  $\nabla$  on the arrow pad once to select, again to deselect → Press the **OK** button to save changes and exit

- You can mark up to 200 pictures for sharing on each card.

## Removing Share Marking from All Pictures (Reset Share Order)

Remove share marking from all pictures on the card in the current slot.

- 1 Press the **MENU** button to display the menus.
- 2 Highlight [Reset share Order] in the  playback menu and press  $\triangleright$  on the arrow pad.



- 3 Highlight [Yes] using the  $\Delta$   $\nabla$  buttons and press the **OK** button.

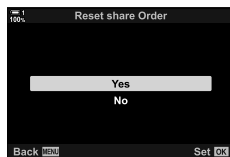

- 4 Press the **MENU** button repeatedly to exit the menus.



This operation can also be applied to multiple selected pictures.  “Selecting Multiple Pictures (On/Copy Select/Erase Selected/Share Order Selected)” (P. 279)

# Selecting Multiple Pictures

## (/Copy Select/Erase Selected/Share Order Selected)

You can select multiple pictures for protection, copying, deletion, or sharing.





- 1 Press the  button.
  - The most recent picture will be displayed.

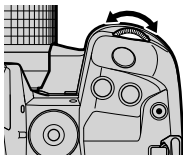

- 2 Rotate the front dial to display a picture you want to share.



2

- 3 Press the  button.
  - A  (“selected”) icon will be displayed.
  - Press the  button again to deselect the picture.
  - When an unmarked image is displayed, you can hold the  button and rotate the front or rear dial to select all images displayed while the dial is rotated. Any previously-marked images displayed while the dial is rotated will be unaffected.

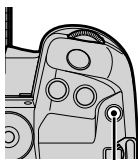

 button

“Selected” icon



- When a marked image is displayed, you can hold the  button and rotate the front or rear dial to deselect all images displayed while the dial is rotated. Any previously-unmarked images displayed while the dial is rotated will be unaffected.
- The same operations can be performed during playback zoom or when a picture is selected in the index display.



- 4** After selecting pictures, press the **OK** button.
- To exit without proceeding to Step 5, press the **MENU** button.

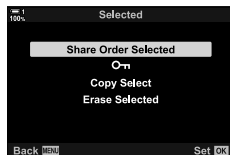

- 5** Highlight the operation you want to perform on the selected pictures ([**OK**], [Copy Select], [Erase Selected], or [Share Order Selected]) and press the **OK** button.
- The selected operation will be applied to all pictures marked with a ✓ icon.
  - If you selected [Copy Select] or [Erase Selected], additional options will be displayed; follow the menus to complete the operation.
- Exiting playback or turning the camera off deselects all selected pictures.

# Adding Audio to Pictures



You can record audio and add it to pictures. The recorded audio provides a simple replacement for written notes about the pictures.

- Audio recordings can be up to 30 s long.

**1** Press the button.

- The most recent picture will be displayed. Display a picture to which you wish to add audio.



**2** Press the **OK** button.

- A menu of edit options will be displayed.

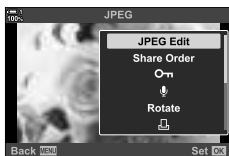

**3** Highlight using  $\Delta$   $\nabla$  on the arrow pad and press the **OK** button.



**4** Highlight and press the **OK** button to start recording.

- To pause recording, select [No].
- To delete an existing recording, highlight [Erase] and press the **OK** button.



**5** Press the **OK** button to end recording.

## ■ Menu Access

You can also use the menus to record audio.

**MENU** button  $\Rightarrow$  (playback menu) tab  $\Rightarrow$  [Edit]  $\Rightarrow$  [Sel. Image]  $\Rightarrow$  Select a picture and press the **OK** button to view options  $\Rightarrow$

- Audio cannot be added to protected images.
- Pictures with audio are indicated by icons and indicators showing the recording rate.







- Audio is recorded at the rate selected for movies. The rate can be selected using [Movie , (P. 413)] in the video menu.

2

## ■ Audio Playback

Playback begins automatically when a picture with audio is displayed. To adjust the volume:

- 1 Press the  button to display a picture.
- 2 Press  or  on the arrow pad.
  -  button: Raise volume.
  -  button: Lower volume.



## Automatically Rotating Portrait-Orientation Pictures for Playback



Choose whether pictures shot in portrait orientation are automatically rotated for display on the camera.

<b>On</b>	Pictures are automatically rotated for display during playback.
<b>Off</b>	Pictures are not automatically rotated for display during playback.

- 1 Press the **MENU** button to display the menus.
- 2 Highlight [] in the playback menu and press on the arrow pad.



- 3 Highlight [On] using the  $\Delta$   $\nabla$  buttons and press the **OK** button.



- 4 Press the **MENU** button to exit the menus.

2

Create retouched copies of pictures. In the case of RAW pictures, you can adjust the settings in effect at the time the picture was taken, such as white balance and picture mode (art filters included). With JPEG pictures, you can make simple edits such as cropping and resizing.



<b>RAW Data Edit</b>	Retouch pictures and save the resulting copies in JPEG format. The following options are available:
	[Current]: Save the picture at the settings currently selected with the camera.
	[Custom1]/[Custom2]: Adjust settings while previewing the results in the display. The settings are saved as [Custom1] or [Custom2].
	[ART BKT]: The camera creates multiple JPEG copies of each image, one for each art filter selected. Select one or more filters and apply them to one or more images.
<b>JPEG Edit</b>	Retouch JPEG pictures and save the resulting copies in JPEG format (P. 287).

## 2

## Retouching RAW Pictures (RAW Data Edit)

[RAW Data Edit] can be used to adjust the following settings. These are also the settings applied when you select [Current].

- Image quality
  - Picture mode
  - White balance
  - Exposure compensation
  - Shadows
  - Mid-tones
  - Highlights
  - Aspect ratio
  - High ISO noise reduction
  - Color space
  - Keystone compensation
- [Color Space] is fixed at [sRGB] when an art filter is selected for picture mode.
  - RAW pictures cannot be retouched if:
    - there is not enough space on the memory card or if the picture was created with a different camera

- 1 Press the **MENU** button to display the menus.
- 2 Highlight [Edit] in the  playback menu and press  on the arrow pad.

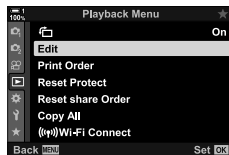



**3** Highlight [Sel. Image] using the  $\Delta$   $\nabla$  buttons and press the **OK** button.

- The pictures on the memory card will be displayed.



**4** Using the  $\triangleleft$   $\triangleright$  buttons, select a picture you want to retouch and press the **OK** button.

- Retouch options will be displayed.
- If the current picture is not a RAW image, [RAW Data Edit] will not be displayed. Select a different image.



**5** Highlight [RAW Data Edit] using the  $\Delta$   $\nabla$  buttons and press the **OK** button.

- Edit options will be displayed.  
To apply current camera settings, highlight [Current] and press the **OK** button. Current settings will be applied. For [Custom1] or [Custom2], highlight the desired option and press the  $\triangleright$  button, then edit settings as follows:
  - An edit menu will be displayed. Highlight items using the  $\Delta$   $\nabla$  buttons and use the  $\triangleleft$   $\triangleright$  buttons to choose settings. Repeat until all the desired settings have been chosen. Press the  $\odot$  button to preview the results.

Highlighting [ART BKT] and pressing the  $\triangleright$  button displays a list of art filters. Highlight art filters and press the **OK** button to select or deselect; selected filters are marked with a  $\checkmark$ . Press the **MENU** button to return to the previous display once all the desired filters have been selected.

**6** Press the **OK** button when settings are complete.

- The selected settings will be applied.

**7** Press the **OK** button again.

- Highlight [Yes] using the  $\Delta$   $\nabla$  buttons and press the **OK** button to save the retouched copy.

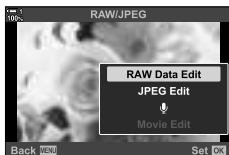





2







- 8** To create additional copies from the same original, highlight [Reset] and press the **OK** button. To exit without creating more copies, highlight [No] and press the **OK** button.
- Selecting [Reset] displays the retouch menu. Repeat the process from Step 5.
  - You can also edit selected pictures during playback.  
 button ➔ Display a picture you want to retouch ➔ Press the **OK** button to view options  
➔ [RAW Data Edit]

The [JPEG Edit] menu contains the following options.

<b>Shadow Adj.</b>	Brighten back-lit subjects.
<b>Red-eye Fix</b>	Reduce "red-eye" in pictures taken with a flash.
	Crop pictures. Size the crop with the front or rear dial and position it with the arrow pad.
<b>Aspect</b>	Change the aspect ratio from the standard 4:3 to [3:2], [16:9], [1:1], or [3:4]. After choosing an aspect ratio, use the arrow pad to position the crop.
<b>Black &amp; White</b>	Create a black-and-white copy of the current picture.
<b>Sepia</b>	Create a sepia copy of the current picture.
<b>Saturation</b>	Adjust the vividness of colors. The results can be previewed in the display.
	Create a resized copy 1280 × 960, 640 × 480, or 320 × 240 pixels in size. Pictures with an aspect ratio other than the standard 4:3 are resized to dimensions as close as possible to the selected option.
<b>e-Portrait</b>	Smooth complexions. The desired effect may not be achieved if no faces are detected.

- Red-eye reduction may not produce the desired results with some pictures.
- Retouch is not available:
  - with pictures that were taken with another camera or edited on a computer or if the space available on the memory card is insufficient.
-  cannot be used to resize pictures to dimensions larger than their original size.
-  and [Aspect] are available only with pictures with the standard 4:3 aspect ratio.

- 1 Press the **MENU** button to display the menus.
- 2 Highlight [Edit] in the  playback menu and press  on the arrow pad.
- 3 Highlight [Sel. Image] using the   buttons and press the **OK** button.
  - The pictures on the memory card will be displayed.



- 4** Using the  $\triangleleft$  $\triangleright$  buttons, select a picture you want to retouch and press the **OK** button.
- Retouch options will be displayed.
  - If the current picture is not a JPEG image, [JPEG Edit] will not be displayed. Select a different image.
- 5** Highlight [JPEG Edit] using the  $\triangle$  $\nabla$  buttons and press the **OK** button.
- An edit menu will be displayed.
- 6** Highlight items using  $\triangle$  $\nabla$  and press the **OK** button.
- The effect can be previewed in the display. If multiple options are listed for the selected item, use the  $\triangle$  $\nabla$  buttons to choose the desired option.
  - When [Aspect] is selected, you can size the crop using the dials and position it using the arrow pad or multi selector.
  - When [Aspect] is selected, you can position the crop using the arrow pad or multi selector.
- 7** Highlight [Yes] using the  $\triangle$  $\nabla$  buttons and press the **OK** button
- The new copy will be saved at the selected settings and the camera will return to the playback display.





- You can also access retouch options when a JPEG picture is displayed during playback:  
 $\triangleright$  button  $\rightarrow$  Display a picture you want to retouch  $\rightarrow$  Press the **OK** button to view options  
 $\rightarrow$  [JPEG Edit]

Overlay existing RAW photos and to create a new picture. Up to 3 pictures can be included in the overlay.

The results can be modified by adjusting brightness (gain) separately for each picture.

- The overlay is saved in the format currently selected for image quality. Overlays created with [RAW] selected for image quality are saved in RAW format and in JPEG format using the image quality option selected for [◀:2] (P. 542).
- Overlays saved in RAW format can in turn be combined with other RAW images to create overlays containing 4 or more pictures.

- 1 Press the **MENU** button to display the menus.
- 2 Highlight [Edit] in the  playback menu and press  on the arrow pad.







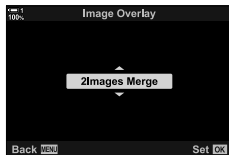

2

- 3 Highlight [Image Overlay] using the   buttons and press the **OK** button.



- 4 Choose the number of pictures to be included in the overlay and press the **OK** button.



- 5 Select RAW pictures using the arrow pad (   ) and press the **OK** button.
  - Selected pictures are marked with a . To deselect, press the **OK** button again.
  - Once you have selected the number of images chosen in Step 4, the overlay dialog will be displayed.

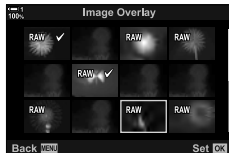

- 6** Adjust gain for the pictures in the overlay.
- Use the  $\triangleleft$  $\triangleright$  buttons to select pictures and the  $\triangle$  $\nabla$  buttons to choose a value.
  - Choose from values of from 0.1 to 2.0. Check the results in the display.

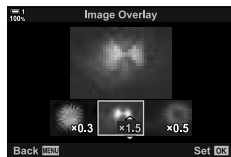

- 7** Press the **OK** button to display a confirmation dialog.
- Highlight [Yes] and press the **OK** button.
- You can also access overlay options when a RAW picture you want to include in an overlay displayed during playback:
-  button  $\Rightarrow$  Press the **OK** button to view options  $\Rightarrow$  [Image Overlay]

You can select pictures for printing and choose the number of copies and the information printed on each picture. The pictures can be printed at print shops that support the Digital Print Order Format (DPOF). A digital print order is stored on the memory card.

The information to be printed on the pictures can be chosen from:

<b>No</b>	No information will be included on the prints.
<b>Date</b>	Each print will include the date the picture was taken.
<b>Time</b>	Each print will include the time the picture was taken.

## ■ Adding Pictures to the Print Order

**1** Press the **OK** button during playback and select [P].

**2** Highlight [P] or [P]ALL and press the **OK** button.

[P]:

- Press <|> on the arrow pad to display a picture you want to add to the print order and press the  $\Delta$   $\nabla$  buttons to choose the number of prints.
- Repeat this step to select additional pictures. To exit, press the **OK** button.

[P]ALL:

- Highlight [P]ALL and press the **OK** button.

**3** Highlight the information you want printed with each picture and press the **OK** button.

- The chosen option applies to all pictures in the print order.

**4** Highlight [Set] and press the **OK** button.

- The selected settings are applied to the pictures on the current memory card.

- The camera cannot be used to edit print orders created with other devices. Creating a print order deletes print orders created with other devices.
- RAW pictures cannot be selected for inclusion in the print order.

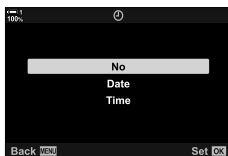

## ■ Removing All or Selected Pictures from the Print Order

You can remove all or selected pictures from the print order.

- 1** Press the **OK** button during playback and select [□].
- 2** Highlight [□] and press the **OK** button.
  - To remove all pictures from the print order, highlight [Reset] and press the **OK** button. To proceed without removing all pictures from the print order, highlight [Keep] and press the **OK** button.
  - You can also remove all pictures from the print order by selecting [□ALL] and choosing [Reset].
- 3** Press ◀▶ on the arrow pad to display a picture you want to remove from the order.
  - Press the △ ▽ buttons to set the number of prints to zero. Repeat this step to remove additional pictures from the order and press the **OK** button when you are done.
- 4** Highlight the information you want printed with the remaining pictures and press the **OK** button.
  - The selected settings apply to all the remaining pictures.
  - The selected settings apply to the pictures on the current memory card.
- 5** Highlight [Set] and press the **OK** button.





# 3 Shooting and Viewing Movies

---

Read this chapter for information on using the camera to record movies. This chapter also covers the features needed to record movies and view them on the camera.

## 3-1 Basic Recording and Playback

The  (movie) button can be used for basic movie recording even in still photography modes. The camera also offers a dedicated  (movie) mode for advanced movie recording. Basic recording and playback operations are the same in either case.

### An Introduction to Movie Recording

You can film movies using the camera's dedicated  (movie) mode or perform basic recording operations without ending still photography.

In both cases, shots can be framed in the viewfinder or monitor. Use the monitor if you want to focus by touching your subject in the display or reposition the focus target during shooting. Movies are recorded using the  (movie) button.

Movie-related options and indicators can be displayed by rotating the mode dial to select  (movie) mode.

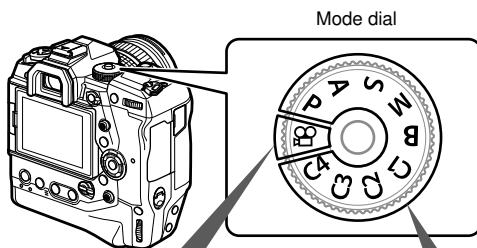

3

#### (movie) mode

A dedicated movie mode. You can choose settings unavailable in or different from those that apply in still photography modes.

Choose this mode if you will primarily be filming movies.

#### Still photography modes

Movies are filmed using program AE.

Choose these modes to film movies during still photography.

\* Some settings are the same as in still photography.

This chapter focuses primarily on filming movies in  (movie) mode.

# Recording Movies

## Holding the Camera

- Keep your fingers or objects such as the camera strap away from the lens.

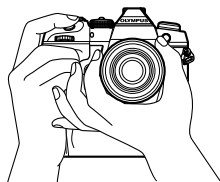

## Recording Movies with the Touch Screen

When the mode dial is rotated to  (movie), the movie recording display will appear in the monitor. You can film movies using touch controls.

- 1 Rotate the mode dial to .
  - Movie recording info will be displayed.
  - Movies can also be filmed in modes **P**, **A**, **S**, and **M**. In this case, photo shooting info will be displayed.

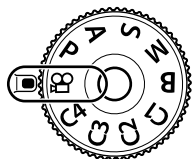

- 2 Position the AF frame over your subject.
  - At default settings, [C-AF] is selected for  AF Mode] (P. 345) and the camera will continually adjust focus for changes in the distance to the subject in the AF frame.



AF frame

- 3 To focus on a subject in a different area of the frame without changing the composition, touch the display.
  - The camera will focus on the selected location, indicated by a green border (AF target).
  - To return the AF target to the center of the frame, press and hold the **OK** button.
  - Press the **OK** button again. The camera will focus on the selected location and the AF target will disappear.



AF target

#### 4 Press the (movie) button to start recording.

- The camera will start the recording count and display the recording time.
- You can tap the display at any time during recording to shift focus to a new location.

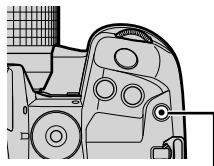



 (movie) button



Recording time

#### 5 Press the button again to end recording.

- Do not touch the display with your fingernails or pointed objects.
- Touch controls may not function as expected if you are wearing gloves or the monitor is covered with a protective sheet.
- The AF frame varies with the option chosen for AF-target selection. The area covered by the AF target can be chosen in the AF-target selection display (P. 352). The AF frame is not displayed when  (all targets) is chosen for AF-target selection.
- Touch controls are not available in some circumstances, including:
  - in the one-touch WB white balance metering display and while camera buttons or dials are in use.
- Movies cannot be recorded:
  - in **B** (bulb) mode or using interval-timer photography, keystone compensation, fisheye correction, or the live ND filter
- Movies over 4 GB in size are recorded over multiple files (depending on shooting conditions, the camera may start recording to a new file before the 4 GB limit is reached). The files can be played back as a single movie.  "Viewing Movies over 4 GB in Size" (P. 301)
- CMOS image sensors of the type used in the camera generate a so-called "rolling shutter" effect that can cause distortion in pictures of moving objects. This distortion is a physical phenomenon that occurs in pictures of fast-moving subjects or if the camera is moved during shooting. It is particularly noticeable in pictures taken at long focal lengths.
- When the camera is used continuously for extended periods, the temperature of the image sensor will rise and noise and color splotches may be visible in the display. Should this occur, turn the camera off and wait for it to cool. Noise and color splotches are particularly likely to occur at high ISO sensitivities. If the temperature of the sensor increases further, the camera will turn off automatically.
- The camera may be unable to compensate for excessive shake.



- You can select different options for [AF Mode] (P. 345).
- You can zoom in on the AF target (P. 364). Use this feature for greater precision when focusing using manual focus (MF).
- You can configure the display so that it does not automatically switch from the monitor to the viewfinder. [EVF Auto Switch] (P. 553)
- Touch controls can be disabled. [Touchscreen Settings] (P. 559)

## Remote Photography

You can use remote photography when the camera is on a tripod or in other situations in which you wish to avoid camera blur caused by operating the shutter button. You can either use an optional RM-CB2 remote cable or take pictures remotely via a wireless connection using the OI.Share smartphone app.

### ■ Using a Remote Cable

Open the remote cable terminal cover and connect the remote cable.

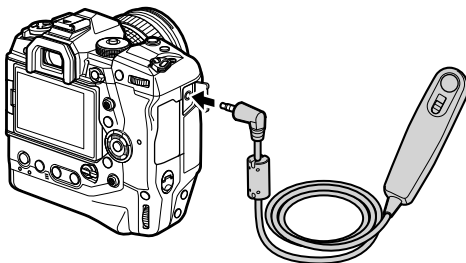

3



- Before using the remote cable to record movies, you will need to select [REC] for [Shutter Function] (P. 423).



### ■ Using OI.Share

The camera must be configured for use with a smartphone. Install OI.Share on your smartphone before proceeding. [6-2 Connecting to Smartphones via Wi-Fi] (P. 584)

## Touch Screen Options

When touch controls are enabled, you can touch your subject in the display to focus or to position or zoom in on the AF target.

- 1 Tap  in the monitor to choose an option.
  - The option selected changes each time you tap .

	Touch controls disabled.
	Tap to position the AF target and focus. You can resize or position the AF frame with your fingers. Press the  (movie) button to shoot.

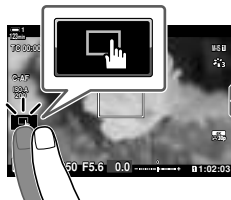

## Focus Zoom



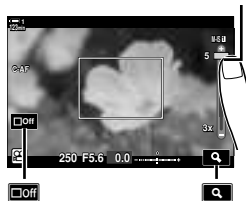

- 1 Tap your subject.
  - An AF target is displayed.
  - Adjust the size of the target using the slider.
  - To hide the target, tap .

Slider







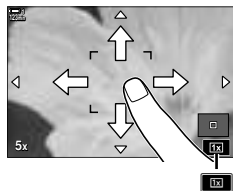

3

- 2 After adjusting the size of the target with the slider, tap  to zoom the target in.
  - While zoom is in effect, you can slide your finger to scroll the display.
  - To exit zoom, tap .



- Touch controls are not available in some circumstances, including:
  - in the one-touch WB white balance metering display and while camera buttons or dials are in use.



- Touch controls can be disabled.  [Touchscreen Settings] (P. 559)
- Focus zoom can be assigned to a camera control. Assign [>] to the desired control using the [ Button/Dial/Lever] > [ Button Function] (P. 417) option in the  video menu. At default settings, focus zoom is assigned to the  (preview) button.

## Using the Viewfinder

Putting your eye to the viewfinder turns it on and turns the monitor off.

- 1 Rotate the mode dial to .
  - Movie recording info will be displayed.
  - Movies can also be filmed in modes **P**, **A**, **S**, and **M**. In this case, photo shooting info will be displayed.

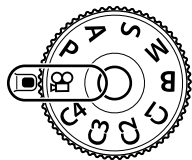

- 2 Position the AF frame over your subject.
  - The camera will automatically focus on the subject in the AF frame.

At default settings, [C-AF] is selected for  AF Mode] (P. 345) and the camera will continually adjust focus for changes in the distance to the subject in the AF frame.



AF frame

- 3 Press the  (movie) button to start recording.
  - The camera will start the recording count and display the recording time.

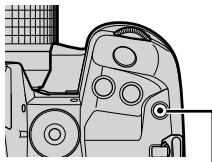



 (movie) button



Recording time

- 4 Press the  button again to end recording.







- You can position the AF target using the multi selector.  [AF Target Point] (P. 352)
- You can position the AF target using monitor touch controls while framing the shot in the viewfinder.  [AF Targeting Pad] (P. 486)

3

# Viewing Movies

View movies stored on the memory cards.

## 1 Press the button.

- The most recent picture will be displayed (single-frame playback).
- Use the multi selector () or front dial () or  or  on the arrow pad to view other pictures.
- To return to the shooting display, press the shutter button halfway.



Single-frame playback (movie)

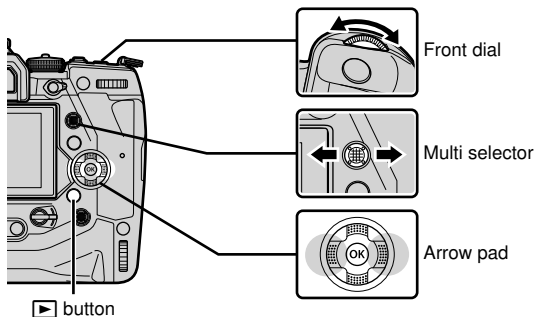

View previous picture   View next picture



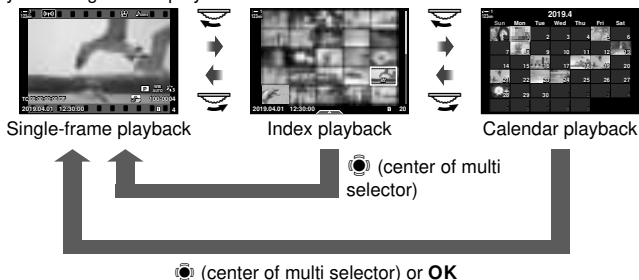

## 2 Rotate the rear dial () to cycle through the playback displays.

- Cycle through the displays as follows:



- To return to single-frame playback from the index playback display, press the multi selector.
- To return to single-frame playback from the calendar playback display, press the **OK** button.
- You can choose the number of pictures in the index playback display using [/Info Settings] (P. 515) > [ Settings] in  Custom Menu **D1**.



- 3 Display a movie and press the **OK** button.
  - Movie playback options will be displayed.
  - If the movie exceeds 4 GB in size, a list options will be displayed.  "Viewing Movies over 4 GB in Size" (P. 301)
- 4 Highlight [Play Movie] and press the **OK** button.
  - Playback will start.
  - Use the  $\triangleleft$   $\triangleright$  buttons to rewind or fast-forward. To pause playback, press the **OK** button again. While playback is paused, you can press the  $\triangle$  button to return to the first frame or the  $\nabla$  button to skip to the last frame. Use the  $\triangleleft$   $\triangleright$  buttons or the front dial () to rewind or advance a frame at a time. To end playback, press the **MENU** button.



## Playback Volume

To adjust the volume for movie playback.

- 1 Press the  button to display a picture.
- 2 Press  $\triangle$  or  $\nabla$  on the arrow pad.
  - $\triangle$  button: Raise volume.
  - $\nabla$  button: Lower volume.



3

## Viewing Movies over 4 GB in Size

Long movies may exceed 4 GB in size. Movies over 4 GB in size are recorded over multiple files. The files can be played back as a single movie.

- 1 Press the  button.
  - The most recent picture will be displayed.
- 2 Display a long movie you want to view and press the **OK** button.
  - The following options will be displayed.
 

[Play from Beginning]:	View the entire movie.
[Play Movie]:	View only the current file.
[Delete entire  ]:	Delete the entire movie.
[Erase]:	Delete only the current file.



## Choosing a Memory Card

When two memory cards are inserted, you can switch slots without leaving playback.

- 1 Press the  button.
  - The most recent picture will be displayed.



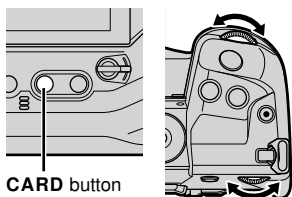

- 2 Hold the **CARD** (card select) button, rotate the front or rear dial to choose a card slot, and then release the **CARD** button.



- The number of the slot currently selected is shown in the playback display.





Current slot

- You can also switch slots using the  button. Press the  button and rotate the front or rear dial to choose a slot during playback.

## Playback Using Touch Controls

Movies can be viewed using touch controls.

- 1 Press the  button to view pictures.
- 2 Touch the monitor and slide your finger left or right.
  - Flick left to view the next picture, right to view the previous picture.
- 3 Tap the display.
  - A touch-sensitive menu will be displayed. Tap  to view thumbnails. To return to single-frame playback, tap .
- 4 Press the **OK** button to display movie options.
  - Highlight [Play Movie] using  $\Delta \nabla$  on the arrow pad and press the **OK** button. Movie playback will start.

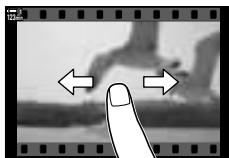

3

## 3-2 Shooting Settings

The camera offers many recording-related functions. Settings can be adjusted using any of the following methods; choose a method according to shooting conditions and how often the setting is accessed.

<b>Direct buttons</b>	Exposure compensation, white balance, and other frequently-used settings are assigned to buttons. Press the buttons to access the settings directly.
<b>LV super control panel</b>	This panel lists shooting settings. Highlight settings in the panel and choose options. Current settings are also listed.
<b>Live controls</b>	Like the super control panel, live controls list shooting settings. Use live controls to adjust settings while previewing your subject in the display.
<b>Menus</b>	Use the menus for settings that cannot be accessed by other means or to customize the camera for ease of use. The menus also contain items pertaining to camera operation and camera controls.

## Direct Buttons

Frequently-used shooting functions are assigned to the camera's buttons, dials, and other controls. These are referred to as "direct buttons". Included are the controls listed below, which can be used for basic shooting settings.

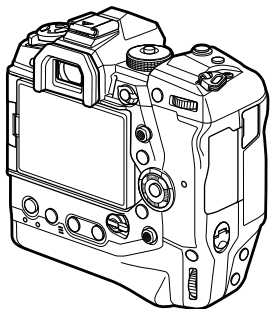

Direct button	Assigned function
(one-touch white balance button) button	Focus peaking
(preview) button	Zoom
<b>Fn</b> button	[] (AF-target selection)
<b>AEL/AFL</b> button	AEL/AFL
Arrow pad	[] (AF-target selection)
button	Exposure compensation
<b>ISO</b> button	ISO sensitivity
<b>WB</b> button	White balance
<b>AF</b> button	AF/metering mode
(LV) button	Display (monitor/viewfinder) selection
button	Movie recording

3

- 1 Press the desired button.
  - The camera will display options for the chosen function.













Options

- 2 Rotate the front or rear dial to select the desired option.
  - In some cases additional options can be displayed by pressing the **INFO** button.

Frequently-used options can be accessed via touch controls. This prevents the sound of the buttons being recorded with movies. By default, a silent control tab is displayed when you select  (movie) mode; if it is not, it can be displayed using the menus. The following controls are listed:



Silent control tab

 (power zoom)	Zoom power zoom lenses in or out.
 (headphone volume)	Adjust volume when using headphones.
 (recording level)	Choose the recording level.
<b>SS</b> (shutter speed)	Adjust shutter speed when <b>S</b> (shutter-priority AE) or <b>M</b> (manual) is selected for [  Mode] (P. 332).
<b>FNo</b> (aperture)	Adjust aperture when <b>A</b> (aperture-priority AE) or <b>M</b> (manual) is selected for [  Mode] (P. 332).
 (exposure compensation)	Adjust exposure compensation. If <b>M</b> is selected for [  Mode] (P. 332), exposure compensation is available when [AUTO] is selected for [  ISO] (P. 369).
<b>ISO</b> (  ISO sensitivity)	Adjust [  ISO] (P. 369). This option is available when <b>M</b> is selected for [  Mode] (P. 332).

3

- Silent controls are not available during high-speed movie recording (P. 339).

## ■ Using Silent Controls

Using silent controls prevents the sound of the buttons being recorded with movies and helps reduce blur caused by camera shake.

- 1 Tap the silent control tab in the display.
  - Silent controls will be displayed.
  - To hide silent controls, tap the silent control tab again.



Silent control tab

- 2 Tap the desired control.
  - Options will be displayed.





- 3 Choose an option.
  - Tap  $\wedge \vee \blacktriangle \blacktriangledown$  to choose an option.
  - To return to the silent control tab and select a different control, tap  $\square$ .
  - The highlighted option will be selected automatically if no operations are performed for 8 seconds.
- 4 Tap the silent control tab to hide silent controls.
  - The silent control tab will close.

## ■ Displaying the Silent Control Tab

Use the menus to hide or display the silent control tab. When the tab is not displayed, it can be displayed using the menus.

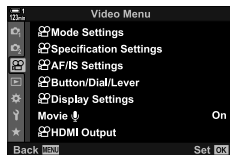
- 1 Press the **MENU** button to display the menus.
- 2 Highlight the  (video menu) tab using  $\Delta$   $\nabla$  on the arrow pad and press the  $\triangleright$  button.



- 3 Highlight [ Display Settings] using the  $\Delta$   $\nabla$  buttons and press the  $\triangleright$  button.

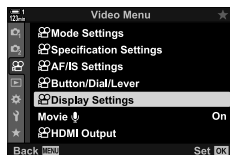

- 4 Highlight [ Info Settings] using the  $\Delta$   $\nabla$  buttons and press the  $\triangleright$  button, then highlight [Custom1] or [Custom2] and press the  $\triangleright$  button.

- A list of available shooting indicators will be displayed.

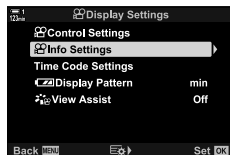

- 5 Highlight [Silent  Operation] using the  $\Delta$   $\nabla$  buttons and press the **OK** button.

- Selected options are marked with a  $\checkmark$ . To deselect, press the **OK** button again.

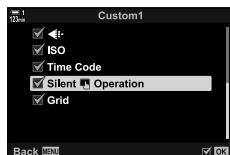





- 6 Press the **MENU** button repeatedly to exit the menus.

- The silent control tab will appear in the  (movie) mode shooting display.
- If the silent control tab is not displayed, press the **INFO** button repeatedly until it appears.





Silent control tab

- The [Custom 2] display is hidden by default. It can be displayed using [ Display Settings] > [ Info Settings] in the  video menu.  [ Info Settings] (P. 429)



# The LV Super Control Panel

Access shooting settings via the list displayed in the LV super control panel. You can also check current settings. The panel lists settings for both still photography and movie recording.





- The settings listed in still photography modes differ from those displayed in  (movie) mode.  “Settings Available in the Super Control/LV Super Control Panel” (P. 65)

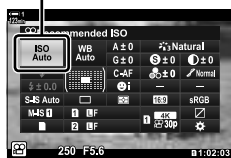

- 1 Select  mode and press the **OK** button.
  - The LV super control panel will be displayed.

Cursor



- 2 Rotate the rear dial or tap to select a setting in display.
  - The selected setting will be highlighted.
  - You can also highlight settings using the multi selector or arrow pad (   ).

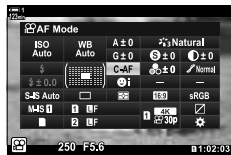

3

- 3 Rotate the front dial to change the highlighted setting.

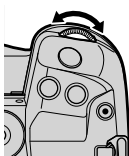

- 4 Press the shutter button halfway to accept current settings and exit the LV super control panel.

## ■ Additional Options

Pressing the **OK** button in Step 2 displays options for the highlighted setting. In some cases, additional options can be viewed by pressing the **INFO** button.

**INFO** button

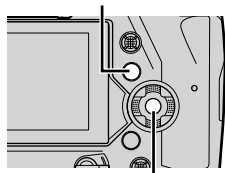

**OK** button



[Image Stabilizer]

- Touch controls can be used in place of the **OK** button. Lightly tap the desired setting twice to display options.

## ■ Settings Available in the LV Super Control Panel

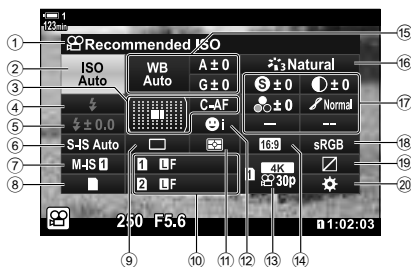

- |   |   |
|---|---|
| ① Option currently selected                     | ⑬ Picture mode..... P. 388                |
| ② ISO sensitivity ..... P. 369                  | ⑭ Sharpness..... P. 396                   |
| ③ AF mode..... P. 345                           | ⑮ Contrast ..... P. 397                   |
| AF-target mode..... P. 120, 349                 | ⑯ Saturation ..... P. 398                 |
| ④ Flash mode*1                                  | ⑰ Tone gradation..... P. 399              |
| ⑤ Flash compensation*1                          | ⑱ Color filter ..... P. 400               |
| ⑥ image stabilization*1 ..... P. 176            | ⑲ Tint..... P. 401                        |
| ⑦ image stabilization..... P. 376               | ⑳ Effect..... P. 402                      |
| ⑧ storage options (save slot) ..... P. 316, 319 | ㉑ Color*3 ..... P. 407                    |
| ⑨ Drive mode (sequential shooting/self-timer)*1 | ㉒ Color/Vivid*4 ..... P. 405              |
| ⑩ image quality*1 ..... P. 78                   | Effect*5 ..... P. 407                     |
| ⑪ Metering mode..... P. 367                     | ⑱ Color space                             |
| ⑫ face priority ..... P. 360                    | ⑲ Highlight & shadow control ..... P. 403 |
| ⑬ image quality ..... P. 321, 339               | ⑳ Control assignment..... P. 417          |
| ⑭ Aspect ratio                                  |   |
| ⑮ white balance ..... P. 380                    |   |
| white balance compensation..... P. 384          |   |
| color temperature*2 ..... P. 380                |   |

\*1 For still photography only. See "2 Taking and Viewing Photographs" (P. 51).

\*2 Displayed when CWB (custom white balance) is selected for white balance.

\*3 Displayed when "Partial Color" is selected.

\*4 Displayed when "Color Creator" is selected.

\*5 Displayed when an art filter is selected.

- The following settings cannot be adjusted in (movie) mode:  
drive mode, metering, flash mode, flash compensation, aspect ratio, and color space.

## Using Live Controls

Live controls are used to view and adjust settings during live view. The effects of the selected settings can be previewed in the live view display. At default settings, live controls can be accessed from the LV super control panel. If you are unable to access live controls, their display can be enabled in the menus.

- 1 Select  mode and press the **OK** button.
  - The LV super control panel will be displayed.



- 2 Press the **INFO** button.
  - Live controls will be displayed.

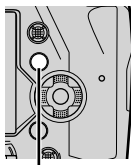

INFO button

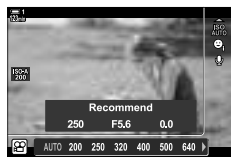

Live controls

- 3 Highlight a setting using  $\Delta$   $\nabla$  on the arrow pad, then highlight an option using the  $\triangleleft$   $\triangleright$  buttons and press the **OK** button to select.
  - Settings can also be adjusted using the dials. Use the rear dial to highlight a setting and the front dial to choose an option.
  - The highlighted option will be selected automatically if no operations are performed for about 8 seconds.
  - Live controls will be displayed when next you press the **OK** button.

### ■ Viewing Live Controls

If live controls are not displayed when you press the **INFO** button in the LV super control panel, their display can be enabled from the menus.

- 1 Press the **MENU** button to display the menus.
- 2 Highlight the  (video menu) tab using  $\Delta$   $\nabla$  on the arrow pad and press the **OK** button.



- 3 Highlight [Display Settings] using the  $\Delta$   $\nabla$  buttons and press the  $\triangleright$  button.

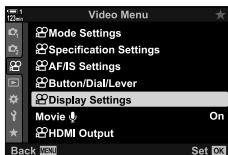

- 4 Highlight [Control Settings] using the  $\Delta$   $\nabla$  buttons and press the  $\triangleright$  button, then highlight [Live Control] and press the **OK** button again.

- A check (✓) will appear next to [Live Control].
- To exit the menus, press the **MENU** button repeatedly or press the shutter button halfway.

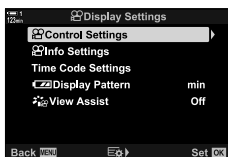

## ■ Available Live Controls











image stabilization ..... P. 376	mode (movie exposure mode) ..... P. 332
Picture mode ..... P. 388	AF mode ..... P. 345
white balance ..... P. 380	ISO sensitivity ..... P. 369
Drive mode (sequential shooting/self-timer) * ..... P. 151	face priority ..... P. 360
image quality ..... P. 321, 339	movie audio ..... P. 413



\* For still photography only. Not available in movie mode.

## Using the Menu

Items not listed in the control panels can be found in the menus, including items for adjusting shooting and playback settings and customizing the camera for ease of use.



Tab	Tab name	Description
	Shooting Menu 1 * <sup>1</sup>	Photography-related items. Ready the camera for shooting or access basic photo settings.
	Shooting Menu 2 * <sup>1</sup>	Photography-related items. Adjust advanced photo settings.
	Video Menu	Items related to movie recording. Adjust basic and custom settings.
	Playback Menu	Playback- and retouch-related items.
	Custom Menu	Items for customizing the camera.
	Setup Menu	Items for setting the clock, choosing a language, and the like.
	My Menu * <sup>2</sup>	A customizable menu containing only items you select.  "Creating a Personalized Menu (My Menu)" (P. 477)

\*<sup>1</sup>  Shooting Menu 1 and  Shooting Menu 2 are for still photography. See "2 Taking and Viewing Photographs" (P. 51).

\*<sup>2</sup> "My Menu" contains no items at shipment. Use "My Menu" to store and organize frequently-used items from other menus. Select items for addition to "My Menu" from the camera menus (P. 477).

- 1 Press the **MENU** button to display the menus.



- Tool tips are displayed for roughly 2 seconds after an item is highlighted. Press the **INFO** button to view or hide tool tips.

- 2 Highlight a tab using  $\Delta$   $\nabla$  on the arrow pad and press the **OK** button.

- Selecting the **Custom Menu** tab displays group tabs. Highlight a group tab using the  $\Delta$   $\nabla$  buttons and press the **OK** button to select.

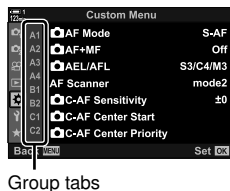

- 3 Highlight an item using the  $\Delta$   $\nabla$  buttons and press the **OK** button to view options.

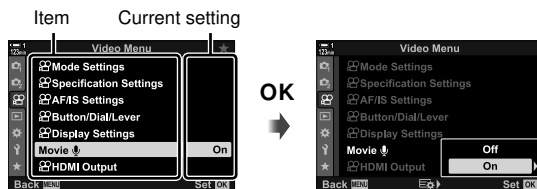

- 4 Highlight options using the  $\Delta$   $\nabla$  buttons and press the **OK** button to select.

- Press the **MENU** button repeatedly to exit the menus.
- Depending on camera status and settings, some items may be unavailable. Items that are not available are grayed out and cannot be selected.
- You can also navigate the menus using the multi selector or the front or rear dials in place of the arrow pad.

## 3-3 Card-Related Settings

This section describes memory-card–related settings. In movie mode, you can choose the card used to store movies. You can also choose the folder used to store movies.

For information on the memory cards that can be used for movie recording, see “Memory Cards” (P. 37).

3

### Choosing a Card for Movies

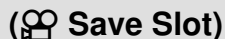

Choose the memory card used to store movies when two memory cards are inserted.

- This setting can be accessed via:
  - The LV super control panel
  - The menus (P. 317)

#### ■ Access via the LV Super Control Panel

- 1 Highlight [📷 Save Settings] in the LV super control panel and press the **OK** button.



📷 save settings



- 2 Highlight [Save Slot] using  $\Delta$   $\nabla$  on the arrow pad and press the  $\blacktriangleright$  button.

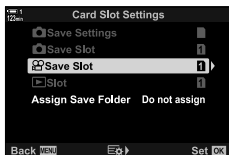

- 3 Highlight an option using the rear dial or the  $\Delta$   $\nabla$  buttons.

[1]: Movies are recorded to the card in Slot 1.

[2]: Movies are recorded to the card in Slot 2.



- 4 Press the **OK** button to select the highlighted option.
- 5 Press the **MENU** button repeatedly to exit the menu.

### ■ Menu Access

Choose a setting using [Card Slot Settings] (P. 547) > [Save Slot] in **Custom Menu**.

**MENU** button  $\Rightarrow$  **Custom menu** tab  $\Rightarrow$  **Hi** tab  $\Rightarrow$  [Card Slot Settings]  $\Rightarrow$  [Save Slot]  
 $\Rightarrow$  Press  $\blacktriangleright$  on the arrow pad to view options  $\Rightarrow$  Use the  $\Delta$   $\nabla$  buttons to choose an option

3

## Storage Slot Selection

When two memory cards are inserted, the card used to store new pictures can be selected using the **CARD** (card select) button.

**1** Press the **CARD** button.

- In  (movie) mode, the camera will display [Save Slot] options.

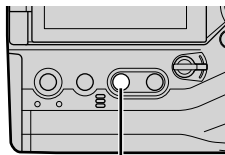

CARD button

**2** Rotate the front or rear dial to choose the desired slot.

[1]: Record pictures to the card in Slot 1.

[2]: Record pictures to the card in Slot 2.

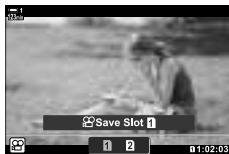

**3** Press the **OK** button to exit.

- The icon for the selected card will be displayed.



Save slot

## Storage Folder Selection (Assign Save Folder)

Choose the folder in which subsequent pictures will be stored. This option is available even when only one memory card is inserted.

- This setting can be accessed via:
  - The LV super control panel
  - The menus (P. 320)

<b>New Folder</b>	Create a new folder as the destination for subsequent pictures.
<b>Existing Folder</b>	Choose an existing folder.

- A new folder cannot be created if a folder with the same name exists on either card.

### ■ Access via the LV Super Control Panel

- 1 Highlight [📷 Save Settings] in the LV super control panel and press the **OK** button.
  - [Card Slot Settings] options will be displayed.

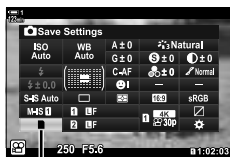

📷 save settings

- 2 Highlight [Assign Save Folder] using  $\Delta$   $\nabla$  on the arrow pad and press the  $\blacktriangleright$  button.

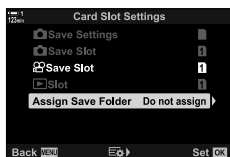

3

- 3 Highlight [Assign] using the  $\Delta$   $\nabla$  buttons and press the **OK** button.



- 4** Highlight an option using the  $\Delta$   $\nabla$  buttons.  
[New Folder]: Choose the desired folder number and press the **OK** button.  
[Existing Folder]: Highlight an existing folder using the  $\Delta$   $\nabla$  buttons and press the **OK** button. The camera will display the first two photos and the last photo in the selected folder.



- 5** Press the **OK** button to select the highlighted option.  
**6** Press the **MENU** button repeatedly to exit the menus.

### ■ Menu Access

Choose a setting using [Card Slot Settings] (P. 547) > [Assign Save Folder] in

⚙ Custom Menu **H1**.

**MENU** button  $\Rightarrow$  ⚙ (custom menu) tab  $\Rightarrow$  **H1** tab  $\Rightarrow$  [Card Slot Settings]  $\Rightarrow$  [Assign Save Folder]  $\Rightarrow$  Press  $\blacktriangleright$  on the arrow pad to view options  $\Rightarrow$  Use the  $\Delta$   $\nabla$  buttons to choose an option

## 3-4 Movie File Settings

Choose the frame size and frame rate at which movies are recorded. The camera can store multiple user-selected combinations of frame size and rate for quick recall via the LV super control panel or live controls. The camera also records time codes that can be used, for example, when editing movies.

3

### Frame Size, Rate, and Compression



Choose the image quality options available for movie recording. When choosing an option, consider how the movie will be used: for example, are you planning to process it on a computer, or is it intended for upload to a website? The camera can store multiple combinations of frame size, rate, and compression from which you can select according to your goals. Slow- and fast-motion and high-speed movie options are also available. “Filming Slow- or Fast-Motion Movies (Slow- and Fast-Motion Movies)” (P. 342) and “Filming High-Speed Movies ( )” (P. 339)





- This setting can be accessed via:
  - The LV super control panel (P. 323)
  - Live controls (P. 323)
  - The menus (P. 323)

Option	Description
<b>Setting 1, 2, 3, or 4</b>	Choose frame size, rate, and compression settings.
<b>Custom</b>	Choose frame size, rate, and compression settings and slow/fast motion options.
<b>High speed</b>	Choose the frame rate.

- Movies are saved in MPEG-4 AVC/H.264 format.

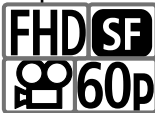
## The Movie Quality Icon

Changes to settings are reflected in the  icon as shown below.

	<b>Frame size</b>		
	<b>FHD</b>	Full HD* <sup>1</sup>	1920 × 1080
	<b>HD</b>	HD* <sup>1</sup>	1280 × 720
	<b>4K</b>	4K* <sup>1</sup>	3840 × 2160
	<b>C4K</b>	4K Digital Cinema* <sup>1</sup>	4096 × 2160
	<b>Compression/bit rate</b>		
	<b>A-I</b>	All Intra* <sup>2</sup>	<ul style="list-style-type: none"><li>• Not available when [4K] or [C4K] is selected for [Movie Resolution].</li></ul>
	<b>SF</b>	Super Fine	
	<b>F</b>	Fine	
	<b>N</b>	Normal	
<b>Frame rate</b>			
<b>60p</b>	60p: 59.94 fps	<ul style="list-style-type: none"><li>• [60p] and [50p] are not available when:<ul style="list-style-type: none"><li>- [FHD] is selected for [Movie Resolution] and [A-I] is selected for bit rate</li><li>- [4K] or [C4K] is selected for [Movie Resolution]</li></ul></li><li>• Selecting [C4K] for [Movie Resolution] fixes [Frame Rate] at [24p].</li></ul>	
<b>50p</b>	50p: 50.00 fps		
<b>30p</b>	30p: 29.97 fps		
<b>25p</b>	25p: 25.00 fps		
<b>24p</b>	24p: 23.98 fps 24p: 24.00 fps (C4K)		
<b>Movie type</b>			
	Setting 1, 2, 3, or 4: Save up to four combinations of frame size, rate, and compression for later use.		
	Custom: Choose frame sizes of 4K or 4K Digital Cinema. You can also shoot fast- or slow-motion movies (P. 342).		
—	High-speed movie  "Filming High-Speed Movies (  )" (P. 339)		

\*1 Movies are saved in MPEG-4 AVC/H.264 format. Individual movie files can be up to 4 GB in size. Continuous shots can be no more than 29 minutes in length.

\*2 "All-Intra" movies use no inter-frame compression. This suits them to editing but increases file size.

- Depending on the card used, recording may end before the maximum length is reached.
- Bit-rate selection may be unavailable at some settings.
- Movies are recorded at an aspect ratio of 16:9. C4K movies are recorded at an aspect ratio of 17:9.

## ■ Access via the LV Super Control Panel

- 1 Highlight  in the LV super control panel and press the **OK** button.



- Movie quality options will be displayed.

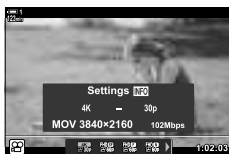
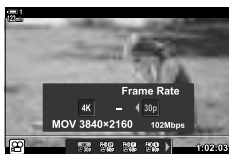

 image quality

- 2 Choose a movie quality option using the front dial.













- You can adjust settings for the selected mode. Press the **INFO** button to position the cursor in the setting menu. Highlight settings using  on the arrow pad and use the   buttons to choose the values.



3

## ■ Menu Access

Movie image quality settings can also be accessed via the menus. Choose settings using  in the  video menu.

**MENU** button   (video) tab   Specification Settings    Press  on the arrow pad to view options

## ■ Access via Live Controls

**OK** button    Press   on the arrow pad to choose an option

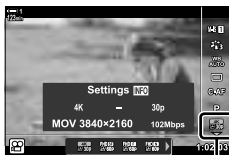

 image quality

Adjust time code settings. Time codes are used to synchronize picture and sound during editing and the like. Choose from the following options.

<b>Time Code Mode</b>	Choose a time code recording option. Use time codes where precise timing is required. [Drop Frame]: Drop-frame time codes. The time code is adjusted to compensate for deviations from the recording time. [Non-DF]: Non-drop-frame time codes. The time code is not adjusted to compensate for deviations from the recording time.
<b>Count Up</b>	Choose how the time count is incremented. [Rec Run]: The count is incremented only during recording. [Free Run]: The count is incremented continuously, including when recording is not in progress or the camera is off.
<b>Starting Time</b>	Choose the starting time code. [Reset]: Reset the time code to 00:00:00 [Current Time]: Set the time code to the current time, frame 00. [Manual Input]: Enter the time code manually.

3

- 1 Press the **MENU** button to display the menus.
- 2 Highlight [⌘ Display Settings] in the ⌘ video menu and press **▶** on the arrow pad.
- 3 Highlight [Time Code Settings] using the **Δ** **∇** buttons and press the **▶** button.
- 4 Highlight an item using the **Δ** **∇** buttons and press the **▶** button.

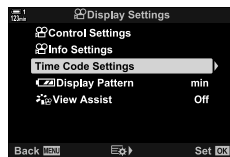
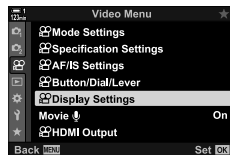



- 5** Highlight an option using the  $\Delta$   $\nabla$  buttons and press the **OK** button.
- If you selected [Starting Time], choose from [Reset], [Manual Input], and [Current Time] and press the **OK** button. If you selected [Manual Input], choose a value using the arrow pad.

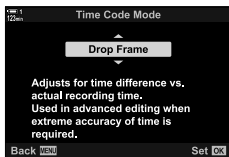

- 6** Press the **MENU** button repeatedly to exit the menus.

## 3-5 The Viewfinder and Monitor Displays

The camera uses an eye sensor to automatically switch between the monitor and viewfinder displays. The monitor live view display and viewfinder also show information on camera settings. Options are available for controlling display switching and choosing the information shown.

### Framing movies in the monitor



Monitor



Put your eye to the viewfinder



### Framing movies in the viewfinder



Viewfinder



Live view in monitor shooting display



Putting your eye to the viewfinder turns the viewfinder on. The monitor turns off while the viewfinder is on.

- Display switching and viewfinder display options are available in the menus.  [EVF Auto Switch] (P. 553), [EVF Style] (P. 554)

# Choosing the Information Displayed

Choose the indicators shown in the shooting display.

## 1 Press the **INFO** button repeatedly.

- The information displayed changes each time the **INFO** button is pressed.

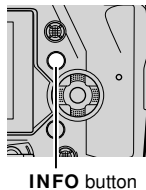
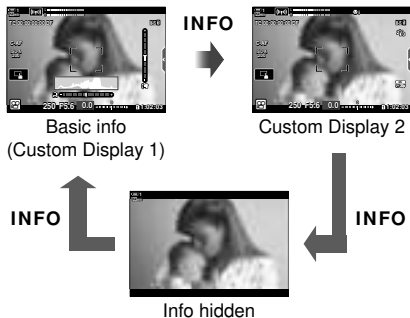

- At default settings, the basic info display shows the indicators selected for Custom Display 1. Custom Display 2 is hidden. These settings can be changed via the menus. You can also display data from GPS and other sensors. Use [INFO Display Settings] > [INFO Info Settings] (P. 429).
- You can also hold the **INFO** button and rotate the front or rear dial to choose the information displayed. The displays can be cycled in either direction.

## Histograms

Histograms graph the distribution of brightness in an image. The horizontal axis shows brightness, the vertical axis the number of pixels. During shooting, pixels brighter than the upper limit are shown in red and pixels darker than the lower limit in blue.

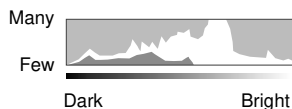

## The Level Gauge

The level gauge shows camera tilt. Pitch is shown by the vertical bar, roll by the horizontal bar. The level gauge is intended as a guide only.

## Display Selection Options (EVF Auto Switch)

Choose how the camera selects the display used for live view.

- This setting can be accessed via:
  - The **|O|** button
  - The menus

### ■ Using the **|O|** (LV) Button

- 1 Press and hold the **|O|** button.
  - The [EVF Auto Switch] menu will be displayed.

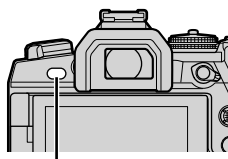

**|O|** button

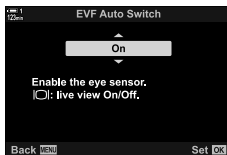

- 2 Highlight an option using  $\Delta$   $\nabla$  on the arrow pad and press the **OK** button.  
[On]: The display switches to the viewfinder when you put your eye to the viewfinder and to the monitor when you take your eye away.  
[Off]: Press the **|O|** button to switch back and forth between the monitor and viewfinder.

### ■ Menu Access







Adjust settings using [EVF Auto Switch] (P. 553) in **⚙** Custom Menu **1**.

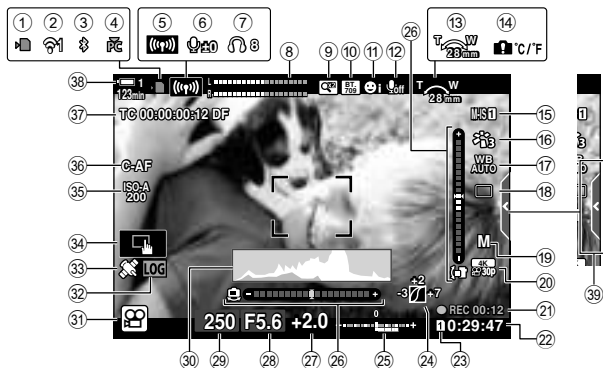



**MENU** button  $\Rightarrow$  **⚙** (custom menu) tab  $\Rightarrow$  **1** tab  $\Rightarrow$  [EVF Auto Switch]  $\Rightarrow$  Press  $\triangleright$  on the arrow pad to view options and use the  $\Delta$   $\nabla$  button to choose an option

# The Shooting Display

The following indicators are displayed when the camera is in  (movie) mode. The indicators displayed can be chosen in the menus.



- |  |  |
|--|--|
| ① Memory card access indicator..... P. 37  | ②① Image quality..... P. 321   |
| ② Wireless LAN connection status..... P. 584, 600  | ②② Time elapsed (displayed during recording)..... P. 295   |
| ③ Active <b>Bluetooth</b> ® connection..... P. 586   | ②③ Time available..... P. 655  |
| ④ Active connection to computer..... P. 600  | ②④  save slot..... P. 316         |
| ⑤ Wireless LAN connection..... P. 592, 596, 597  | ②⑤ Highlight & shadow control..... P. 403  |
| ⑥ Audio recording level*1..... P. 424  | ②⑥ Exposure compensation..... P. 367   |
| ⑦ Headphone volume*1..... P. 424   | ②⑦ Level gauge..... P. 327   |
| ⑧ Audio recording level meter..... P. 413  | ②⑧ Exposure compensation value..... P. 367   |
| ⑨ Digital teleconverter.....P. 411   | ②⑨ Aperture value.....P. 334–338   |
| ⑩  view assist..... P. 395                | ②⑩ Shutter speed.....P. 334–338  |
| ⑪ Face priority..... P. 360  | ③① Histogram..... P. 327   |
| ⑫ Movie audio recording..... P. 413  | ③② Shooting mode.....P. 93–110   |
| ⑬ Zoom direction/focal length  | ③③ Log status..... P. 571  |
| ⑭ Internal temperature warning..... P. 639   | ③④ GPS status..... P. 570  |
| ⑮  image stabilization..... P. 376      | ③⑤ Touch controls.....P. 298   |
| ⑯ Picture mode..... P. 388   | ③⑥  ISO sensitivity..... P. 369 |
| ⑰  white balance..... P. 380            | ③⑦  AF mode..... P. 345         |
| ⑱ Drive mode (single-frame only)*2   | ③⑧ Time code..... P. 324   |
| ⑲  mode (movie exposure mode)... P. 332 | ③⑨ Battery level..... P. 44  |
|  | ③⑩ Silent control tab..... P. 306  |

\*1 Displayed during adjustments to [ VOL] and [ VOL].  “Touch Controls (Silent Controls)” (P. 306) and [ Dial Function] (P. 424)

\*2 Drive mode selection is not available in movie mode.

## Viewfinder (Movie Recording)

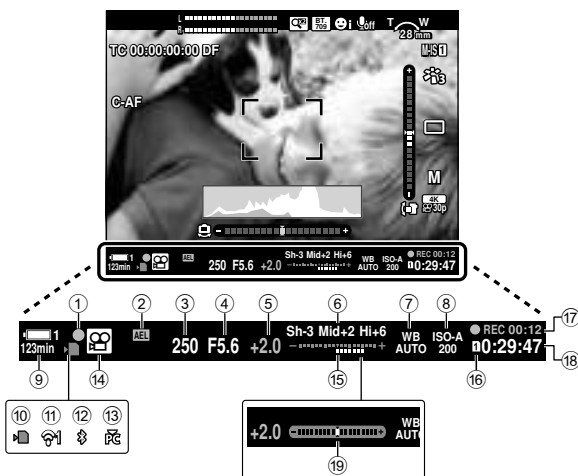

- This is the default display style ([Style 2]). The display style can be selected using Custom Menu **1** > [EVF Style] (P. 554). To display the same information as appears in the monitor, choose [Style 3] for [EVF Style].

- |  |  |
|--|--|
| ① In-focus indicator ..... P. 345                  | ⑫ Active <b>Bluetooth</b> <sup>®</sup> connection ..... P. 586 |
| ② Exposure lock ..... P. 373                       | ⑬ Active connection to computer..... P. 600                    |
| ③ Shutter speed ..... P. 334–338                   | ⑭ Shooting mode..... P. 294                                    |
| ④ Aperture value ..... P. 334–338                  | ⑮ Exposure compensation ..... P. 367                           |
| ⑤ Exposure compensation value..... P. 367          | ⑯  save slot ..... P. 316                                      |
| ⑥ Highlight & shadow control ..... P. 403          | ⑰  Time elapsed (displayed during recording)..... P. 295       |
| ⑦  white balance ..... P. 380                      | ⑱ Time available..... P. 655                                   |
| ⑧  ISO sensitivity ..... P. 369                    | ⑲ Level gauge * ..... P. 556                                   |
| ⑨ Battery level/bay number ..... P. 44             |  |
| ⑩ Memory card access indicator ..... P. 37         |  |
| ⑪ Wireless LAN connection status ..... P. 584, 600 |  |

\* Displayed while the shutter button is pressed halfway. [Half Way Level] (P. 556)

Reset the camera to factory default settings. You can opt to reset almost all settings or only those directly related to photography.

- This option applies in both still photography and movie modes.

- 1 Press the **MENU** button to display the menus.
- 2 Highlight [Reset / Custom Modes] in Shooting Menu 1 and press **▶** on the arrow pad.



- 3 Highlight [Reset] using the  $\Delta$   $\nabla$  buttons and press the **▶** button.



- 4 Highlight an option using the  $\Delta$   $\nabla$  buttons.
  - [Full]: Reset all settings with a few exceptions, such as the clock and language.
  - [Basic]: Reset photography-related settings only.



- 5 Press the **OK** button to select the highlighted option.
  - The [Reset / Custom Modes] menu will be displayed.
- 6 Press **OK** in the [Reset / Custom Modes] menu.
  - The [Reset] menu will be displayed.
- 7 Highlight [Yes] using the  $\Delta$   $\nabla$  buttons and press the **OK** button.
  - Settings will be reset.

## 3-6 Movie Recording Options

Adjust shutter speed and aperture to suit your subject. You can exploit depth of field and motion blur just as you would when taking photos. You'll also find it easy to record slow- and fast-motion movies and to film at extremely high frame rates for ultra-clear slow-motion playback.

3

### Choosing an Exposure Mode

( Mode)

Adjust aperture and shutter speed to suit your artistic intent. The selected settings only take effect when the mode dial is rotated to . Movies shot in still photography modes are filmed using program AE.

- This setting can be accessed via:
  - The menus (P. 333)
  - Live controls (P. 333)
- See the page numbers listed below for more information.

<b>P Program AE</b> (P. 334)	The camera controls aperture and shutter speed.
<b>A Aperture-priority AE</b> (P. 335)	Use aperture to control depth of field.
<b>S Shutter-priority AE</b> (P. 336)	Adjust shutter speed according to subject motion and the movie frame rate.
<b>M Manual exposure</b> (P. 337)	Freely adjust both aperture and shutter speed.



## ■ Menu Access

- 1 Press the **MENU** button to display the menus.
- 2 Highlight [Mode Settings] in the video menu and press **▶** on the arrow pad.
- 3 Highlight [Mode] (movie exposure mode) using the **▲▼** buttons and press the **▶** button.
  - [Mode] options will be displayed.
- 4 Highlight the desired mode using the **▲▼** buttons and press the **OK** button.
  - The video menu will be displayed.
- 5 Press the **MENU** button repeatedly to exit the menus.

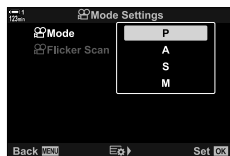
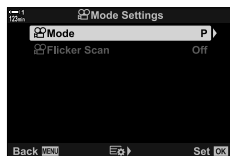
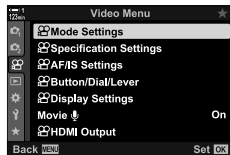

## ■ Access via Live Controls

The exposure mode for movies can be selected using live controls.

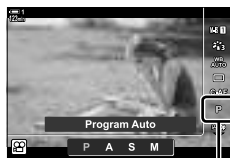

 Mode

**OK** button ➔ [Mode] (movie exposure mode) ➔ Press **<▶** on the arrow pad to choose an option

3

## Letting the Camera Choose Aperture and Shutter Speed (P: Program AE)

The camera chooses the optimal aperture and shutter speed according to subject brightness. This option can be combined with exposure compensation.





- 1 Focus and check the display.
  - The shutter speed and aperture chosen by the camera are displayed.
- 2 Record movies.







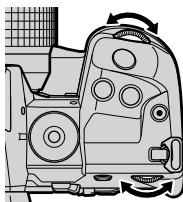

Shutter speed

### ■ Adjusting Settings in Mode P

The front and rear dials can be used for exposure compensation.  “Adjusting Exposure (Exposure Compensation)” (P. 367)

- The  button can also be used for exposure compensation. Hold the  button and rotate the front or rear dial. You can also adjust exposure compensation by pressing the  button and using   on the arrow pad.



- You can choose the functions performed by the front and rear dials.   video menu >  Dial Function] (P. 424)
- You can use the **Fn** lever to reverse the roles of the front and rear dials. The lever can also be assigned other roles.   video menu >  Fn Lever Function] (P. 426)

## Choosing an Aperture (A: Aperture-Priority AE)

In this mode, you choose the aperture (f/-number) and the camera automatically sets the shutter speed for optimal exposure according to subject brightness. Lower aperture values (larger apertures) reduce the depth of the area that appears to be in focus (depth of field), blurring the background. Higher aperture values (smaller apertures) increase the depth of the area that appears to be in focus in front of and behind the subject.

Lower aperture values...

F2.8 ← F4.0 ← F5.6 →

...reduce depth of field and increase blur.

Higher aperture values...

F8.0 → F11

...increase depth of field.

### 1 Choose an aperture.

- At default settings, aperture is selected by rotating the rear dial.
- The shutter speed selected automatically by the camera will appear in the display.
- You can adjust exposure compensation (P. 367). At default settings, exposure compensation can be adjusted using the front dial.

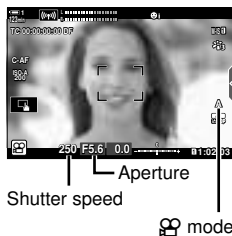











### 2 Record movies.

## ■ Adjusting Settings in Mode A

Use the front and rear dials to adjust the following settings.

Front dial: Exposure compensation (P. 367)

Rear dial: Aperture

- Exposure compensation can also be adjusted using the  button. Press the  button and rotate the front or rear dial. You can also adjust exposure compensation by pressing the  button and using  on the arrow pad.
- You can choose the functions performed by the front and rear dials.   video menu > [ Dial Function] (P. 424)
- You can use the **Fn** lever to reverse the roles of the front and rear dials. The lever can also be assigned other roles.   video menu > [ Fn Lever Function] (P. 426)

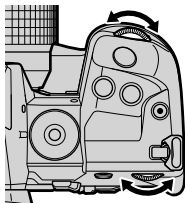

## Choosing a Shutter Speed (S: Shutter-Priority AE)

In this mode, you choose the shutter speed and the camera automatically sets aperture for optimal exposure according to subject brightness. Choose a shutter speed according to subject motion and movie frame rate. If subject motion seems jerky, choosing a slow shutter speed will smooth the subject's apparent motion.

Slower shutter speeds...

Faster shutter speeds...

24 ← 30 ← 60 → 125 → 250 ||| → 32000

### 1 Choose a shutter speed.

- At default settings, shutter speed is selected by rotating the rear dial. Choose from shutter speeds of 1/24 to 1/32000 s.
- The aperture selected automatically by the camera will appear in the display.
- You can adjust exposure compensation (P. 367). At default settings, exposure compensation can be adjusted using the front dial.

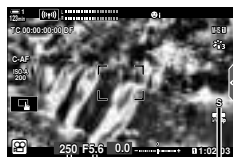

Shutter speed

Aperture

mode

### 2 Record movies.

- The slowest shutter speed available varies with the frame rate selected for movie image quality.













3

## ■ Adjusting Settings in Mode S

Use the front and rear dials to adjust the following settings.

Front dial: Exposure compensation (P. 367)

Rear dial: Shutter speed

- Exposure compensation can also be adjusted using the  button. Press the  button and rotate the front or rear dial. You can also adjust exposure compensation by pressing the  button and using  on the arrow pad.
- You can choose the functions performed by the front and rear dials.   video menu >  [Dial Function] (P. 424)
- You can use the **Fn** lever to reverse the roles of the front and rear dials. The lever can also be assigned other roles.   video menu >  [Fn Lever Function] (P. 426)
- Depending on the shutter speed selected, you may notice banding in the display caused by flicker from fluorescent or LED light sources. The camera can be configured to reduce the effects of flicker during live view or movie recording.  [Flicker reduction] (P. 190),  [Flicker Scan] (P. 374)

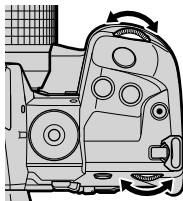

## Choosing Aperture and Shutter Speed (M: Manual Exposure)

In this mode, you choose the aperture and shutter speed. Shooting at a fixed aperture and shutter speed makes any changes in the brightness of the subject or the scene readily apparent.

### 1 Adjust aperture and shutter speed.

- At default settings, aperture is selected with the front dial and shutter speed with the rear dial.
- Choose from shutter speeds of 1/24–1/32000 s. Values of ISO 200–6400 are available using the [ISO] manual sensitivity control options.
- The display shows the difference between the exposure produced by the selected aperture and shutter speed and the optimal exposure metered by the camera. The display will flash if the difference exceeds  $\pm 3$  EV.



Difference from optimal exposure

mode

### 2 Record movies.

- If subject motion seems jerky, choosing a slow shutter speed will smooth the subject's apparent motion.
- The slowest shutter speed available varies with the frame rate selected for movie image quality.

## ■ Adjusting Settings in Mode M

Use the front and rear dials to adjust the following settings.

Front dial: Aperture

Rear dial: Shutter speed

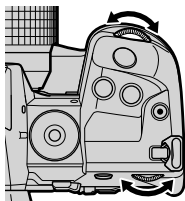

3

- You can choose the functions performed by the front and rear dials. video menu > [Dial Function] (P. 424)
- You can use the **Fn** lever to reverse the roles of the front and rear dials. The lever can also be assigned other roles. video menu > [Fn Lever Function] (P. 426)



## ■ Using Exposure Compensation in Mode M

In mode **M**, exposure compensation is available when [AUTO] is selected for [ISO]. Because exposure compensation is performed by adjusting ISO sensitivity, exposure can be adjusted without changing shutter speed or aperture.

☞ “Adjusting ISO Sensitivity (ISO)” (P. 369)

When [On] is selected for [M ISO-Auto], [ISO] can be set to [AUTO].

☞ [M ISO-Auto] (P. 372)

- Exposure compensation can be adjusted using the  button. Hold the  button and rotate the front or rear dial.
- Exposure compensation is included in the deviation from optimal exposure shown by the exposure indicator in the display.



Exposure compensation

Deviation from optimal exposure  
(includes exposure compensation)

- Depending on the shutter speed selected, you may notice banding in the display caused by flicker from fluorescent or LED light sources. The camera can be configured to reduce the effects of flicker during live view or movie recording. ☞ [Flicker reduction] (P. 190), [Flicker Scan] (P. 374)

Film at high frame rates. Movies are filmed at 120 fps and play back at 60 fps. Stretching playback to double the recording time (as is the case when 60p is selected as the playback frame rate) lets you view in slow motion movements that in real life took only the blink of an eye.

A high-speed movie option can be included in the movie image quality menu. Your choice of playback frame rate determines the playback speed multiplier.

Changes to settings are reflected in the movie quality icon as shown.

	<b>Frame size</b>	<b>FHD</b> Full HD (1920 × 1080)
	<b>Movie type</b>	<b>HS</b> High speed (120 fps)
	<b>Playback frame rate</b>	<b>60p</b> 60p: 59.94 fps; plays back at 0.5× speed
		<b>50p</b> 50p: 50.00 fps; plays back at 0.42× speed
		<b>30p</b> 30p: 29.97 fps; plays back at 0.25× speed
		<b>25p</b> 25p: 25.00 fps; plays back at 0.21× speed
		<b>24p</b> 24p: 23.98 fps; plays back at 0.2× speed

- This setting can be accessed via:
  - The LV super control panel
  - The menus (P. 341)
  - Live controls (P. 341)

## ■ Access via the LV Super Control Panel

- 1 Highlight in the LV super control panel and press the **OK** button.
  - Movie quality options will be displayed.



image quality

**2** Highlight **FHD HS 60p** (high-speed movie recording) using the front dial.

- To use the options currently selected for high-speed movie recording, press the **OK** button. The camera will exit the menu with the current options selected.

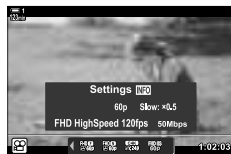

**3** To edit current settings, press the **INFO** button in Step 2.

- This places the cursor in the list of high-speed movie options.

**4** Choose the playback frame rate.

- Use  $\Delta$   $\nabla$  on the arrow pad to highlight the desired playback frame rate.

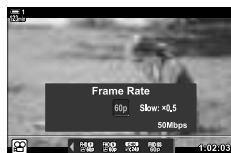

**5** Press the **OK** button to select the highlighted option and exit.

**3**

- Focus, exposure, and white balance lock during recording.
- Sound is not recorded.
- The picture angle is slightly reduced.
- Aperture, shutter speed, exposure compensation, and ISO sensitivity cannot be changed during recording.
- Time codes cannot be recorded or displayed.
- Brightness may change if zoom is adjusted during recording.
- Filming ends when the movie file reaches 4 GB in size.
- High-speed movie recording is not available while the camera is connected to an HDMI device.
- [Image Stabilizer] > [M-IS] is not available.
- [Movie] cannot be used.
- [i-Enhance], [e-Portrait], and art filter picture modes are not available.
- [Gradation] is fixed at [Gradation Normal].
- High-speed movie recording is not available during remote photography when the camera is connected to a smartphone.



## ■ Menu Access

High-speed movie recording can also be accessed via the menus. Choose settings using [MENU] in the [MOVIE] video menu.

**MENU** button → [MOVIE] (movie) tab → [Specification Settings] → [MENU] → Press [OK] on the arrow pad to view options

## ■ Access via Live Controls

**OK** button → [MENU] → Press [OK] on the arrow pad to view options

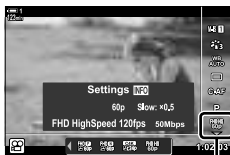
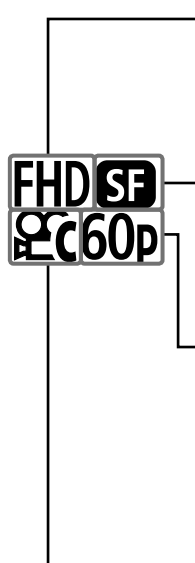

image quality

## Filming Slow- or Fast-Motion Movies (Slow- and Fast-Motion Movies)

Film slow- or fast-motion movies. Choose a recording rate faster than the playback rate for slow-motion movies or slower than the playback rate for fast-motion movies. Slow- and fast-motion recording are available as custom movie image quality options.

Changes to settings are reflected in the movie quality icon as shown.



Frame size		
FHD	Full HD	1920 × 1080
HD	HD	1280 × 720
4K	4K	3840 × 2160
C4K	4K Digital Cinema	4096 × 2160

Compression/bit rate	
A-I	All Intra
SF	Super Fine
F	Fine
N	Normal

Frame rate	
60p	60p: 59.94 fps
50p	50p: 50.00 fps
30p	30p: 29.97 fps
25p	25p: 25.00 fps
24p	24p: 23.98 fps
	24p: 24.00 fps (C4K)

Movie type	
☑	Custom

Slow/fast motion*	
×0.96 or less	Slow motion
OFF	Normal playback speed
×1.04 or more	Fast motion

\* The icon does not indicate the option selected.

- This setting can be accessed via:
  - The LV super control panel (P. 343)
  - The menus (P. 344)
  - Live controls (P. 344)

## ■ Access via the LV Super Control Panel

- 1 Highlight  in the LV super control panel and press the **OK** button.

- Movie quality options will be displayed.

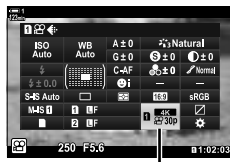





 image quality

- 2 Highlight  (custom) using the front dial and press the **INFO** button.

- Options will be displayed and the cursor will be positioned in the options list.



- 3 Select items using   on the arrow pad and use the   buttons to choose a setting.

- The options available for [Slow or Fast Motion] vary with the settings chosen for frame size and rate. Only fast-motion options are available when [C4K] and [4K] are selected.

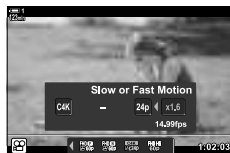

- 4 Press the **OK** button to save changes and exit.

- Sound is not recorded.
- Art filter picture modes are disabled.
- Depending on the option selected for , slow- and/or fast-motion recording may not be available.
- Shutter speed is limited to values no slower than 1/24 s. The slowest speed available varies with the option selected for [Frame Rate].

3

## ■ Access via Live Controls

**OK** button → [ ] → Select [ ] (custom) → Press the **INFO** button, select [Slow or Fast Motion] and choose the desired settings

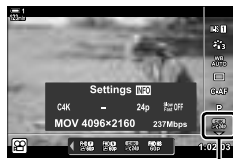

image quality

## ■ Menu Access

Slow- and fast-motion movie recording can also be accessed via the menus. Choose settings using [ ] in the [ ] video menu.

**MENU** button → [ ] (movie) tab → [ ] Specification Settings → [ ] → Press ▷ on the arrow pad → Highlight [ ] (custom) and press the ▷ button → Use the △ ▽ ◀ ▶ buttons to choose settings

## 3-7 Focus

Focus can be adjusted automatically (autofocus) or manually (manual focus).

Autofocus features options for focusing on selected points or for tracking focus on a moving subject. Settings can be customized according to the subject or shooting conditions, allowing you to film a greater variety of subjects. This section describes the settings available and how they can be combined to get the most from autofocus.

### Focus Mode

( AF Mode)

Choose the focus mode for auto or manual focus.

- This setting can be accessed via:
  - The **AF**  button (P. 347)
  - The LV super control panel (P. 347)
  - Live controls (P. 348)
  - The menus (P. 348)

#### Single AF (S-AF and S-AF)

Choose for photographs of subjects that are stationary or not moving away from or toward the camera. The camera focuses once each time the shutter button is pressed halfway.

- When the camera focuses, the in-focus indicator and the active AF target will be displayed. These indicators are not displayed while recording is in progress.
- After focusing in [S-AF ] mode, you can adjust focus manually by rotating the focus ring.



AF target

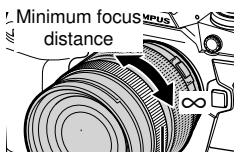

Focus ring

## Continuous AF (C-AF)

Track focus on subjects whose distance to the camera is continuously changing. The camera focuses continuously before and during recording.

## Manual Focus (MF)

Focus manually.

- Rotate the lens focus ring to focus.
- If the lens is equipped with an MF clutch, you can rotate the lens focus ring to engage manual focus regardless of the focus mode selected with the camera.  "Lens MF Clutch (Manual Focus Clutch)" (P. 355)

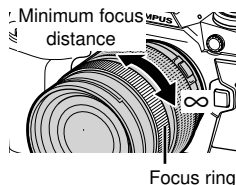

## Tracking AF (C-AF+TR)

Track focus on a specific subject while keeping the composition roughly the same. Touch your subject in the display to start tracking.

- Tracking starts when recording begins.
- An AF target is displayed while tracking is in progress. The target turns red if the camera can no longer track the subject.

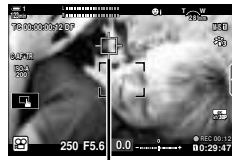



Target displayed while tracking is in progress.



## Preset MF (PreMF)

Select [PreMF] to focus at a preset distance.  "Focusing at a Preset Distance (Preset MF)" (P. 357)



- The default behavior of the AF target is described. Its behavior can be changed in the custom menu.  [AF Area Pointer] (P. 486)
- You can configure the camera to automatically zoom in on the focus target when the lens focus ring is rotated or to highlight outlines that are in focus.  [MF Assist] (P. 495)
- The following focus settings can be recalled simultaneously using the **Fn** lever. Separate settings can be assigned to Positions 1 and 2. Use this option to quickly adjust settings according to shooting conditions.

[AF Mode], [AF Target Mode] (P. 349), and [AF Target Point] (P. 352)

The **Fn** lever can be configured using  [Fn Lever Function] (P. 426) in the  video menu.

## ■ Access via the AF Button

1 Press the AF  button.

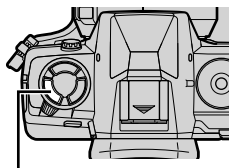

AF  button

- [ AF Mode] options will be displayed.



[ AF Mode] options

2 Rotate the rear dial.

- You can also rotate the dial while pressing the button.

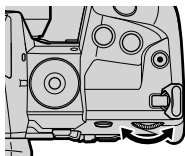



3

3 Press the shutter button halfway to exit to the shooting display.

## ■ Access via the LV Super Control Panel

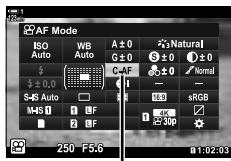
When the mode dial is rotated to  (movie), focus settings can also be adjusted in the LV super control panel.





 AF mode

Press the **OK** button ➔ [ AF Mode] ➔ Rotate the front dial to choose an option

## ■ Access via Live Controls

When the mode dial is rotated to  (movie), focus settings can also be adjusted using live controls.

Highlight [ AF Mode] in the live controls and use   on the arrow pad to choose an option.



 AF mode

## ■ Menu Access

The focus mode can be selected using [ AF/IS Settings] in the  (video) menu.

**MENU** button →  (video menu) tab → [ AF/IS Settings] → [ AF Mode] → Use the   buttons to choose an option



## Choosing an AF Target Mode (AF Target Mode)

The point or area in the frame on which the camera focuses is called the "AF target". [AF Target Mode] is used to choose the number of AF targets used and the size of the area covered. Reducing the number of targets restricts focus to a small area of the frame, while increasing the number expands focus to a larger area. Choose [Single Target] for subjects that are easy to track, [Target Group] or [All Targets] for more elusive subjects.

- This setting can be accessed via:
  - The multi selector (P. 350)
  - The LV super control panel (P. 351)

### [·]: Single Target

Select a single focus target.

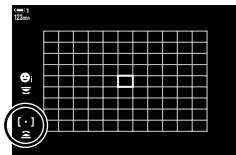

### [3x3]: 9-Target Group (3 x 3)

Select a group of 9 targets, arranged in a square. The camera chooses the target used for focus from within the selected group.

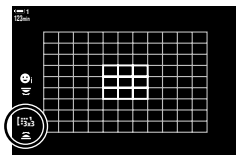

### [5x5]: 25-Target Group (5 x 5)

Select a group of 25 targets, arranged in a square. The camera chooses the target used for focus from within the selected group.

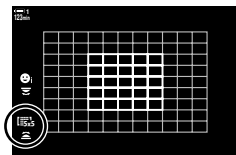

### [ALL]: All Targets (11 x 9)

The camera chooses from all 99 targets.

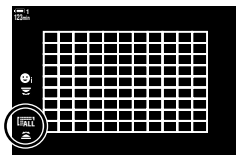

- Selecting [On] for [Digital Tele-converter] (P. 411) reduces the number of targets available.

## ■ Access via the Multi Selector

- 1 Keep the multi selector pressed while rotating the front or rear dial.

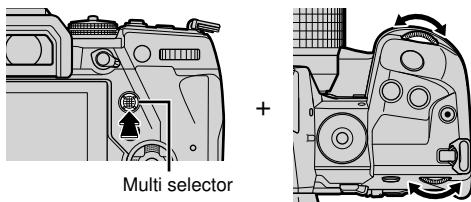

- The camera cycles through AF target modes as shown.

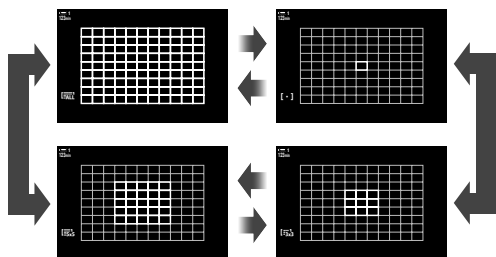

3

- 2 Release the multi selector when the desired mode is displayed.

- AF target mode options will no longer be displayed.
- Assigning [::] (AF-target selection) to the arrow pad or **Fn** button allows the control to be used for AF-target selection. Press the  $\Delta \nabla \triangleleft \triangleright$  buttons to view the AF target display. Use the front dial to choose a target. [::] (AF-target selection) is assigned to the arrow pad by default.



- The following focus settings can be recalled simultaneously using the **Fn** lever. Separate settings can be assigned to Positions 1 and 2. Use this option to quickly adjust settings according to shooting conditions.

[AF Mode], [AF Target Mode] (P. 349), and [AF Target Point] (P. 352)

The **Fn** lever can be configured using [Fn Lever Function] (P. 426) in the video menu.

- Settings can also be adjusted by first pressing a button and then using the front dial. Access the AF-target display by pressing the control to which [::] has been assigned via [Button Function]. You can then adjust settings by rotating the front dial. At default settings, [::] is assigned to the **Fn** button. [Fn Lever Function] (P. 417)

## ■ Access via the LV Super Control Panel

When the mode dial is rotated to  (movie), the AF target mode can also be selected in the LV super control panel.

- 1 Highlight [AF Area] in the LV super control panel and press the **OK** button.



AF area

- AF-target selection will be displayed.

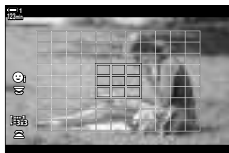

- 2 Rotate the front dial to choose an AF target mode.
  - You can choose the roles played by the front and rear dials or arrow pad during AF-target selection. Use **[[::]]** Select Screen Settings] (P. 488) in **Custom Menu A2**. At default settings, the front dial is used to choose the AF target mode.
- 3 Press the shutter button halfway to exit to the shooting display.

When an option other than [All Targets] is selected for AF target mode, you can position the target or targets over the subject on which you wish to focus. At default settings, the multi selector is used to position the AF target. The target can be moved while filming is in progress.

- This setting can be accessed via:
  - The multi selector
  - The LV super control panel (P. 353)

## ■ Access via the Multi Selector

**1** Use the multi selector to position the AF target.

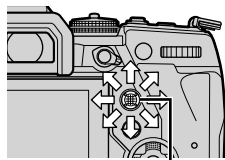

Multi selector

- The AF target is displayed in green at the start of the operation.
- If the AF target is moved during recording, only the moving target will be displayed.
- To select the center AF target, press the multi selector or press and hold the **OK** button.

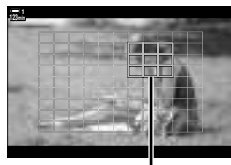

AF target

**2** Take pictures.

- AF target mode options clear from the display when the shutter button is pressed halfway.
- The AF frame is displayed in place of the selected AF target.
- Assigning [::] (AF-target selection) to the arrow pad or **Fn** button allows the arrow pad to be used for AF-target selection. Press the  $\Delta$   $\nabla$   $\triangleleft$   $\triangleright$  buttons to view the AF target display and use the rear dial to choose a target. [::] (AF-target selection) is assigned to the arrow pad by default.
- If you assign [[:]] to a control using [Fn Button Function] (P. 417), you can press the control and then position the AF target using the multi selector or arrow pad. This option is assigned to the **Fn** button by default.



- When [On] is selected for [AF Targeting Pad], you can reposition the AF target using monitor touch controls while framing your subject in the viewfinder. [AF Targeting Pad] (P. 486)
- You can disable the use of the multi selector in the shooting display. [Touch] [Direction Key] (P. 499)
- The following focus settings can be recalled simultaneously using the **Fn** lever. Separate settings can be assigned to Positions 1 and 2. Use this option to quickly adjust settings according to shooting conditions.

[AF Mode], [AF Target Mode] (P. 349), and [AF Target Point] (P. 352)

The **Fn** lever can be configured using [Fn Lever Function] (P. 426) in the video menu.

## ■ Access via the LV Super Control Panel

When the mode dial is rotated to (movie), the AF target can also be selected in the LV super control panel.

- 1 Highlight [AF Area] in the LV super control panel and press the **OK** button.

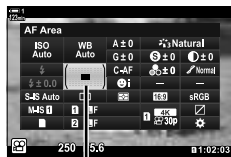

AF area

- AF-target selection will be displayed.
- The number of targets available varies with the AF target mode.

- 2 Use on the arrow pad to position the AF target.

- To select the center AF target, press the multi selector or press and hold the **OK** button.
- You can choose the roles played by the front and rear dials or arrow pad during AF-target selection. Use [Select Screen Settings] (P. 488) in Custom Menu **A2**. At default settings, the front dial is used to choose the AF target mode.

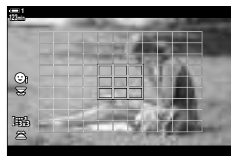





AF target

- 3 Press the shutter button halfway to exit to the shooting display.

- Selecting [On] for [Digital Tele-converter] (P. 411) reduces the number of targets available.

3



- You can disable the use of the multi selector in the shooting display.  [  Direction Key] (P. 499)
- The following focus settings can be recalled simultaneously using the **Fn** lever. Separate settings can be assigned to Positions 1 and 2. Use this option to quickly adjust settings according to shooting conditions.  
[AF Mode], [AF Target Mode] (P. 349), and [AF Target Point] (P. 352)  
The **Fn** lever can be configured using [  Fn Lever Function] (P. 426) in the  video menu.

The “MF clutch” (manual focus clutch) mechanism on MF clutch lenses can be used to switch between auto and manual focus simply by repositioning the focus ring.

- Check the position of the focus ring before shooting.
- Sliding the focus ring to the AF/MF position at the end of the lens selects autofocus, while sliding it to the MF position closer to the camera body selects manual focus, regardless of the focus mode chosen with the camera.

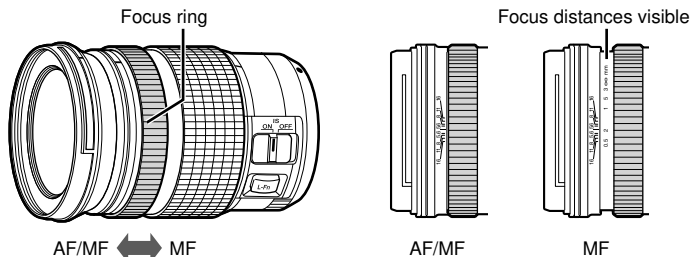

- Selecting [MF] or [PreMF] for focus mode on the camera disables autofocus even when the focus ring is in the AF/MF position.

## Disabling the MF Clutch

(MF Clutch)

Disable the manual focus clutch, which is found on some lenses. This can prevent autofocus being disabled by the clutch engaging accidentally.

1 Press the **MENU** button to display the menus.

2 Select  Custom Menu **A4** (AF/MF).



3 Highlight [MF Clutch] using  $\Delta$   $\nabla$  on the arrow pad and press the  $\blacktriangleright$  button.



4 Use the  $\Delta$   $\nabla$  buttons to highlight an option.

[Operative]: The camera responds to the position of the lens focus ring.

[Inoperative]: The camera focuses according to the option selected for  AF Mode], regardless of the position of the lens focus ring.

5 Press the **OK** button to select the highlighted option.

-  Custom Menu **A4** will be displayed.

6 Press the **MENU** button repeatedly to exit the menus.

- Manual focus using the lens focus ring is not available when [Inoperative] is selected for [MF Clutch], even if the lens focus ring is in the manual focus position.



Quickly focus at a previously-stored distance. This can be used, for example, to focus quickly at infinity. The focus distance can be set using auto or manual focus or by entering the focus distance directly.

If the lens is equipped with a focus limiter, disable it before proceeding.

- The figures displayed are intended as guides only.
- This setting can be accessed via:
  - The **AF** button
  - The LV super control panel (P. 359)
  - Live controls (P. 359)
  - The menus (P. 359)



- [PreMF] (preset MF) can be assigned to a camera control using [Fn Button Function] in the video menu, allowing you to focus at a preset distance at the touch of a button (P. 417).
- The following focus settings can be recalled simultaneously using the **Fn** lever. Separate settings can be assigned to Positions 1 and 2. Use this option to quickly adjust settings according to shooting conditions.

[AF Mode], [AF Target Mode] (P. 349), and [AF Target Point] (P. 352)

The **Fn** lever can be configured using [Fn Lever Function] (P. 426) in the video menu.

## ■ Access via the AF button

- 1 Press the **AF** button.

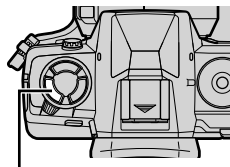

**AF** button

- [AF Mode] options will be displayed.



[AF Mode] options

**2** Highlight [Preset MF] using the rear dial.



**3** Press the **INFO** button.

- You will be prompted to choose the focus distance for [Preset MF].

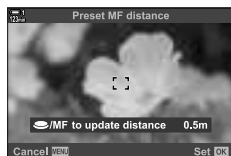

**4** Choose a focus distance.

- To choose a focus distance using autofocus:  
Press the shutter button halfway to focus on a subject at the desired distance.



- To choose a focus distance using manual focus:  
Rotate the lens focus ring and check the distance in the display.

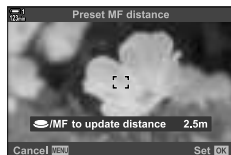



**5** Press the **OK** button to accept the selected focus distance.

- To focus at the distance selected for [Preset MF distance], select [Preset MF] for [AF Mode] (P. 345).
- The camera also focuses at the preset distance:
  - when turned on and
  - when you exit the menus to the shooting display.

3

## ■ Access via the LV Super Control Panel

When the mode dial is rotated to  (movie), preset manual focus can also be selected in the LV super control panel.

Highlight [ AF Mode] > [PreMF] in the LV super control panel, press the **OK** button, and then press the **INFO** button to display options. You can then press the shutter button halfway to focus on a subject at the desired distance, or choose the focus distance manually by rotating the focus ring.



 AF mode

- The camera will focus at the selected distance whenever you select [PreMF] for  AF Mode.

## ■ Access via Live Controls

When the mode dial is rotated to  (movie), preset MF can also be accessed via live controls.

Select [ AF Mode] > [PreMF] in the live controls and press the **INFO** button to display the preset focus distance. You can then press the shutter button halfway to focus on a subject at the desired distance, or choose the focus distance manually by rotating the focus ring.

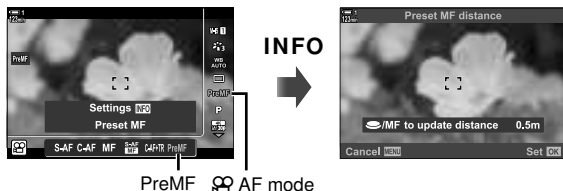

PreMF  AF mode





3

## ■ Menu Access

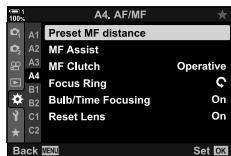
Choose a focus distance using [Preset MF distance] in  Custom Menu **A4**.

- [Preset MF distance] can be used to select the units for the focus distance display; choose from [m] or [ft].
- To focus at the distance selected for [Preset MF distance], select [Preset MF] for  AF Mode) (P. 345).









**MENU** button →  tab → **A4** tab → [Preset MF distance] → Press  on the arrow pad to view options → Use the   buttons to choose a focus distance

# Face Priority AF

The camera automatically detects and focuses on the faces of portrait subjects. Exposure is weighted according to the value metered for the face.

- This setting can be accessed via:
  - The LV super control panel
  - The menus (P. 361)
  - Live controls





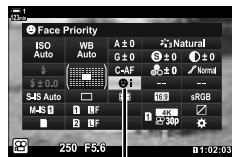

 (face priority on)	The camera detects and focuses on faces.
<b>OFF</b> (face priority off)	Face priority AF off.
 (face and eye priority)	In  (movie) mode, these options function in the same way as  (face priority on).
 (face and right eye priority)	
 (face and left eye priority)	

## ■ Access via the LV Super Control Panel

- 1 Highlight [ Face Priority] in the LV super control panel and press the **OK** button.



 face priority

- 2 Highlight an option using   on the arrow pad.
  - 3 Press the shutter button halfway to select the highlighted option and exit the LV super control panel.
- Assigning [] (AF-target selection) to the arrow pad or **Fn** button allows the arrow pad to be used for AF-target selection. Press the    buttons and use the rear dial to choose a target. [] (AF-target selection) is assigned to the arrow pad by default.

## ■ Access via Live Controls

Face priority AF options can also be accessed by highlighting [☺ Face Priority] in the live controls and selecting an option using <|> on the arrow pad.

- You can also select face priority by rotating the rear dial in the AF-target selection display.



☺ face priority

## ■ Menu Access

Use [☺ Face Priority] in ⚙ Custom Menu **A3**.

**MENU** button → ⚙ tab → **A3** tab → [☺ Face Priority] → Press > on the arrow pad to view options → Use the Δ ∇ buttons to choose an option



These settings can also be accessed using the following methods.

- Highlight [AF Area] in the LV super control panel and press the **OK** button. You can then adjust settings by rotating the rear dial.
- Access the AF-target display by pressing the control to which [[::]] has been assigned via [🔗 Button Function]. You can then adjust settings by rotating the rear dial. At default settings, [[::]] is assigned to the **Fn** button.

## Using Face Priority AF

1

Point the camera at your subject.

- Faces detected by the camera are indicated by white borders.
- A white border is also displayed if a face is detected during manual focus. Exposure will be set according to the value metered for the center of the face.



2

Press the Ⓜ (movie) button to start recording.







- The camera may fail to detect some subjects.
- The white border is not displayed during recording.
- The camera may be unable to detect the subject depending on the settings selected for the [Picture Mode] art filter options (ART1–ART16).
- If the zoom frame is displayed, the camera will focus on the subject in the zoom frame.

3



## C-AF Tracking Sensitivity C-AF Sensitivity

Choose how rapidly the camera responds to changes in the distance to the subject while focusing with [C-AF] or [C-AF+TR] selected for  AF Mode]. This can help autofocus track a quickly-moving subject or prevent the camera refocusing when an object passes between the subject and the camera.

- Choose from three levels of tracking sensitivity.
- Select +1 for increased sensitivity. Choose this option for subjects that are moving toward or away from the camera or changing speed unpredictably or for subjects that suddenly enter the frame.
- Select -1 for reduced sensitivity. Choose this option to prevent the camera refocusing when the subject is briefly obscured by other objects or to prevent the camera focusing on the background when you are unable to keep the AF target positioned over a quickly-moving subject.

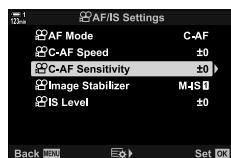
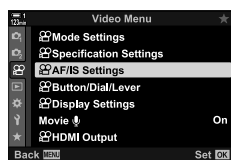
- 1 Press the **MENU** button to display the menus.
- 2 Highlight  AF/IS Settings] in the  video menu and press  on the arrow pad.
- 3 Highlight  C-AF Sensitivity] using the   buttons and press the  button.





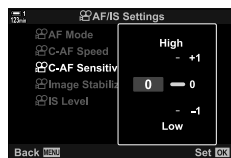







- 4 Highlight the desired option using the   buttons and press the **OK** button.
  -  AF/IS Settings] options will be displayed.



- 5 Press the **MENU** button repeatedly to exit the menus.

Choose how quickly the camera responds to changes to the distance to subject when [C-AF] or [C-AF+TR] is selected for focus mode. This can be used to adjust the time the camera takes to refocus when, for example, you switch subjects.

- Choose from three focus speed levels.
- Refocusing is quicker at +1 and slower at -1. Choose -1 to refocus slowly when shifting to a new subject.

- 1 Press the **MENU** button to display the menus.
- 2 Highlight [ AF/IS Settings] in the  video menu and press  on the arrow pad.
- 3 Highlight [ C-AF Speed] using the   buttons and press the  button.
  - [ AF/IS Settings] options will be displayed.
- 4 Highlight the desired option using the   buttons and press the **OK** button.

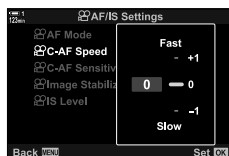
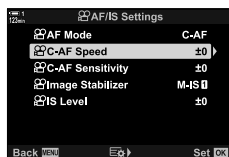
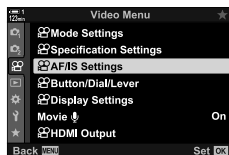

- 5 Press the **MENU** button repeatedly to exit the menus.

## Zoom Frame/Focus Zoom AF

The camera can focus on the area indicated by a zoom frame. For more accurate focus, you can zoom in on the zoom frame. The zoom frame can be moved while recording is in progress.

Focus zoom can be accessed via buttons or touch controls. The former requires that you assign [Q] (Magnify) to a button using [☞ Button Function].

- This setting can be accessed via:
  - Touch controls
  - The Q button (P. 365)
- Focus zoom applies to the display only. Pictures taken with the camera are not affected.

### ■ Access via Touch Controls

You can zoom in on a point selected by touching the display. You can also view other areas of the frame using touch controls.

- 1 Tap the desired location in the frame.
  - A zoom frame, slider, and Q icon will be displayed.
  - The camera will focus on the subject in the zoom frame.
  - The slider and Q can be redisplayed at any time by tapping the display again.
  - Tap anywhere in the display to move the zoom frame to the selected location.
  - Touch the slider and slide it up or down to adjust the size of the zoom frame.

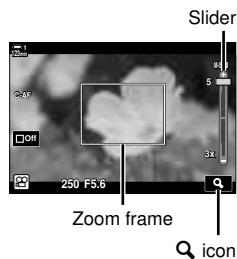

- 2 Tap the Q icon in the display.
  - The camera will zoom in on the zoom frame.
  - Use the front or rear dial to zoom in or out.

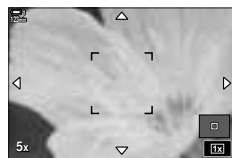



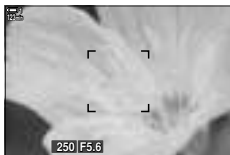

- 3** Slide a finger over the display to zoom in or out.
- Use the multi selector or arrow pad ( $\Delta \nabla \triangleleft \triangleright$ ) to scroll the display.
  - When [M] (manual) is selected for [Mode], you can press the **INFO** button during zoom to choose aperture or shutter speed.
  - Press the **OK** button or tap the  icon to end focus zoom.



Exposure adjustment display when [M] is selected for [Mode]

- 4** Start recording to restore the previous display.
- To hide the zoom frame, press the **OK** button.

## ■ Button Access

To access focus zoom using a button, assign  (magnify) to a control. The [] (magnify) option can be accessed via [Button Function].

### Assigning (Magnify) to a Control

Assign [] (magnify) to a control. To make the assignment via the LV super control panel:

- 1** Highlight [Button Function] in the LV super control panel and press the **OK** button.
- [Button Function] options will be displayed.

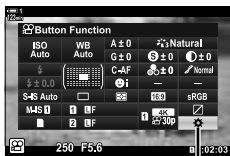

 button function

- 2** Using  $\Delta \nabla$  on the arrow pad, highlight the control to which [] (magnify) will be assigned and then press  $\triangleright$  on the arrow pad.

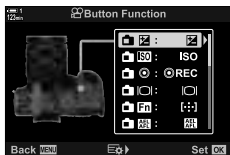

- 3** Highlight [Magnify] using the  $\Delta \nabla$  buttons and press the **OK** button.



- 4 Press the **OK** button again.
  - The menu will clear from the display.
- 5 Press the button to which [**Q**] is assigned.
  - The zoom frame will be displayed.
  - The frame is displayed in the same position as the target most recently used for autofocus.
  - Use the multi selector or arrow pad to position the frame.
  - To re-center the frame, press the multi selector or press and hold the **OK** button.
- 6 To choose the size of the zoom frame, press the **INFO** button.
  - Use the  $\Delta$   $\nabla$  buttons or the front or rear dial to choose the size of the zoom frame.
  - Press the **OK** button to proceed.
- 7 Press the button to which [**Q**] is assigned once more.
  - The camera will zoom the selected area in to fill the display.
  - Use the multi selector to scroll the display.
  - Use the front or rear dial to zoom in or out.
  - When [M] (manual) is selected for [**Mode**], you can press the **INFO** button and adjust aperture or shutter speed.
  - Press the **OK** button to restore the previous display.

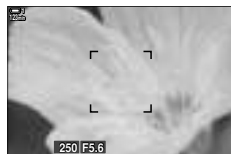
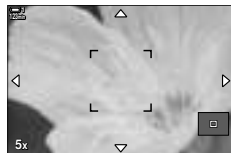

Exposure adjustment display when [M] is selected for [**Mode**]

- 8 Start recording to exit zoom.

## ■ Menu Access

The menu can be used to choose the roles played by camera controls. Use [**Button Function**] in the [**video menu**].

**MENU** button  $\Rightarrow$  [**tab**]  $\Rightarrow$  [**Button/Dial/Lever**]  $\Rightarrow$  [**Button Function**]  $\Rightarrow$  Choose a button  $\Rightarrow$  Press  $\triangleright$  on the arrow pad to view options  $\Rightarrow$  Use the  $\Delta$   $\nabla$  buttons to select [Magnify]

## 3-8 Metering and Exposure





The camera meters subject brightness and adjusts exposure accordingly. The camera can be configured to raise ISO sensitivity automatically when lighting is poor. You can also reduce flicker when shooting under artificial light.

Exposure for movie mode is metered using  (digital ESP) metering. Digital ESP metering is suited to most scenes, including back-lit subjects. The camera meters 324 areas of the frame and calculates optimal exposure taking into consideration the nature of the scene. The camera can also be configured to detect and set exposure for faces.

3



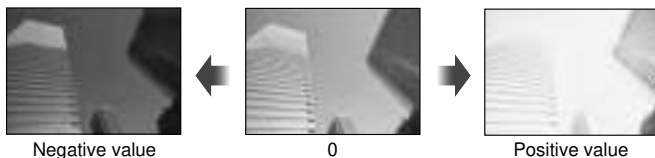

### Adjusting Exposure (Exposure Compensation)

The exposure selected automatically by the camera can be altered to suit your artistic intent. Choose positive values to make pictures brighter, negative values to make them darker. Exposure can be adjusted by  $\pm 3.0$  EV.

- This setting can be accessed via:
  - The  button (P. 368)
  - Touch controls (P. 368)
  - The dials (P. 368)
- Exposure compensation is available when [P], [A], or [S] is selected for  Mode] (movie exposure mode). To enable exposure compensation when [M] is selected for  Mode], select [On] for  ISO-Auto] (P. 372) and choose [AUTO] for  ISO].
- During recording, exposure compensation can be adjusted using the front or rear dial or touch controls.



## ■ Access via the Button





Hold the  button and rotate the front or rear dial. Alternatively, you can press the  button and then use the   buttons on the arrow pad.





Exposure compensation bar

- To reset exposure compensation, press and hold the **OK** button.









-  (exposure compensation) can be assigned to other controls. Use [ Button/Dial/Lever] > [ Button Function] (P. 417) in the  video menu.

## ■ Access via the Dials

When [P], [A], or [S] is selected for [ Mode], exposure compensation can be adjusted using the front dial. To use the front or rear dial in mode [M], select [ for [ Dial Function] (P. 424).

## 3 ■ Access via Touch Controls (Silent Controls)

Exposure compensation can be adjusted using touch controls.  “Touch Controls (Silent Controls)” (P. 306)

- Tap the silent control panel to view silent controls ➔ Tap []
- ➔ Use     to choose a setting



Silent control tab

Adjust ISO sensitivity when [M] is selected for [ISO Mode] (movie exposure mode). Higher values let you photograph darker scenes but also increase image “noise” (mottling). Select [AUTO] to let the camera adjust sensitivity according to lighting conditions. [AUTO] is the only option available when [P], [A], or [S] is selected for [ISO Mode].

- ISO sensitivity can be adjusted while recording is in progress. Use the front or rear dial or touch controls.
- Manual ISO sensitivity adjustment is available only when [M] is selected for [ISO Mode].
- This setting can be accessed via:
  - The **ISO** button (P. 370)
  - The LV super control panel (P. 371)
  - Touch controls (P. 371)
  - Live controls (P. 371)

<b>AUTO</b>	Sensitivity is adjusted automatically according to shooting conditions. The camera adjusts sensitivity in the range ISO 200–6400. In [ISO Mode] (movie exposure mode) [M] (manual), this option is available when [On] is selected for [ISO-Auto] (P. 372).
<b>200–6400 (manual)</b>	Choose a value for [ISO]. ISO 200 offers a good balance between noise and dynamic range. This option is available when [M] is selected for [ISO Mode].

- The range of sensitivities available when [AUTO] is selected varies with the options chosen for [ISO] and [Picture Mode].
- The following restrictions apply when [M] is selected for [ISO Mode]:
  - [Dramatic Tone] or [Watercolor] selected for art filter:
    - The upper limit for [AUTO] is ISO 1600.
  - [OM-Log400] selected for picture mode:
    - If the frame rate selected for [ISO] is 24p, 25p, or 30p, [AUTO] is restricted to sensitivities of ISO 400–3200.
    - If the frame rate selected for [ISO] is 50p or 60p, [AUTO] is restricted to sensitivities of ISO 400–6400.
    - The lowest value that can be selected manually is ISO 200.
- Other picture modes:
  - If the frame rate selected for [ISO] is 24p, 25p, or 30p, [AUTO] is restricted to sensitivities of ISO 200–3200.



- You can choose the maximum and standard ISO sensitivity values available to auto ISO sensitivity control when [AUTO] is selected and [M] is chosen for [ISO Mode]. [ISO-Auto Set] (P. 372)

## ■ Access via the ISO Button

ISO sensitivity for movie recording can only be adjusted when [M] is selected for [Mode]. [AUTO] is available only when [On] is selected for [ISO-Auto] in the video menu (P. 372).

**1** Press the **ISO** button.

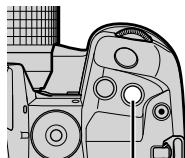

ISO button

- [ISO] options will be displayed.

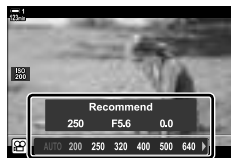

[ISO] options

**2** Rotate the front or rear dial to highlight an option.

- You can also rotate the dials while pressing the **ISO** button.

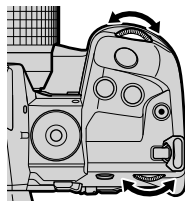







**3** Press the shutter button halfway to select the highlighted option and exit.



- ISO sensitivity can be assigned to other controls. Use [Button/Dial/Lever] > [Button Function] (P. 417) in the video menu.

## ■ Access via Touch Controls (Silent Controls)

When [M] is selected for [ISO Mode], ISO sensitivity can be adjusted using touch controls.  “Touch Controls (Silent Controls)” (P. 306)

Tap the silent control panel to view silent controls  Tap [ISO]  
 Use     to choose a setting



Silent control tab

## ■ Access via the LV Super Control Panel

1 Highlight  ISO in the LV super control panel.

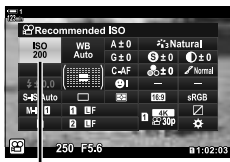



 ISO sensitivity

2 Highlight an option using the front dial.

3 Press the shutter button halfway to select the highlighted option and exit the LV super control panel.

## ■ Access via Live Controls

Highlight  ISO in the live controls and use   on the arrow pad to choose an option.

- For information on displaying live controls, see “Using Live Controls” (P. 312).

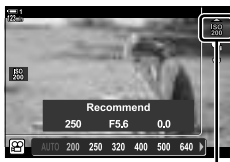



















 ISO sensitivity

3

## Auto ISO Sensitivity Control (MOV ISO-Auto Set)

[AUTO] can be selected for [MOV ISO] in [MOV Mode] (movie exposure mode) [M] (manual). This allows the camera to respond to changes in brightness without you having to adjust aperture or shutter speed. Exposure compensation can also be used.

 <b>MOV ISO-Auto</b>	[AUTO] is available for [MOV ISO] when [M] is selected for [MOV Mode]. Auto ISO sensitivity control settings can be adjusted using [Upper Limit / Default].
<b>Upper Limit / Default</b>	Choose the maximum and standard ISO sensitivity values available to auto ISO sensitivity control when [AUTO] is selected for [MOV ISO] in [MOV Mode] (movie exposure mode) [M].

- 1 Press the **MENU** button to display the menus.
- 2 Highlight [ Specification Settings] in the  video menu and press  on the arrow pad.
- 3 Highlight [ ISO-Auto Set] using the   buttons and press the  button.
- 4 Highlight an option using the   buttons and press the  button.  
[Upper Limit / Default]: Highlight items using the   buttons and use the   buttons to change. Press the **OK** button to return to the [ ISO-Auto Set] display. The options available vary with the picture mode (P. 388).  
[ ISO-Auto]: Highlight [On] or [Off] using the   buttons.
- 5 Press the **MENU** button repeatedly to exit the menus.

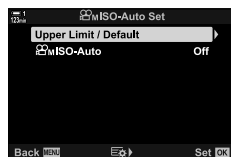
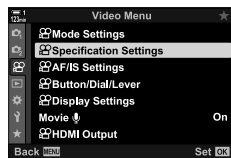



Lock exposure at the metered value. Use this option when you want to set focus and exposure separately.

Exposure lock is performed using a button. Exposure lock ([AEL/AFL]) must therefore be assigned to a button using [Custom Button Function] (P. 417). At default settings, it is assigned to the **AEL/AFL** button.

- 1 Compose the shot to meter the subject for which you want to set exposure and press the **AEL/AFL** button once.

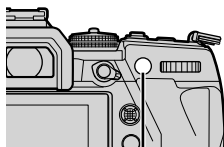

AEL/AFL button

- Press the **AEL/AFL** button once to lock exposure; an **AEL** icon will appear in the display.



AEL icon

- 2 To end exposure lock, press the **AEL/AFL** button again.

- The **AEL** icon will clear from the display.
- Operating the mode dial or the **MENU** or **OK** buttons also ends exposure lock.

3





## Reducing Flicker Under LED Lighting

### Flicker Scan





Banding may occur in movies filmed under LED lighting. Use  Flicker Scan] to optimize shutter speed while viewing banding in the display.

This option is in  Mode] (movie exposure modes) [S] and [M].

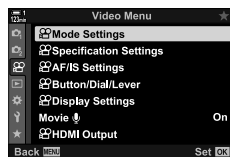
- The range of available shutter speeds is reduced.



- 1 Select [S] or [M] for  Mode] (P. 332).
- 2 Press the **MENU** button to display the menus.
- 3 Highlight  Mode Settings] in the  video menu and press  on the arrow pad.

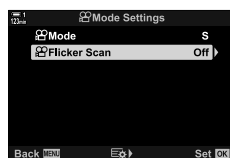

- 4 Highlight  Flicker Scan] using the   buttons and press the  button.

3



- 5 Highlight [On] using the   buttons and press the **OK** button.

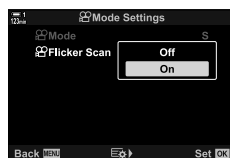

- 6 Press the **MENU** button repeatedly to exit the menus.
  - A **Flicker Scan** icon is displayed when flicker scan is enabled.



Flicker Scan icon

- 7** Choose a shutter speed while viewing the display.
- Choose a shutter speed using the front or rear dial or the  $\Delta$   $\nabla$  buttons.
  - Continue adjusting shutter speed until banding is no longer visible in the display.
  - Press the **INFO** button; the display will change and the **Flicker Scan** icon will no longer be displayed. You can adjust aperture and exposure compensation. Do so using the front or rear dial or the arrow pad.
  - Press the **INFO** button repeatedly to return to the flicker scan display.







Shutter speed

**8** Begin filming when settings are complete.

- Focus peaking, the LV super control panel, and live controls are not available in the flicker scan display. To view these items, first press the **INFO** button to exit the flicker scan display.



- [ Flicker Scan] can be assigned to a button. You then need only press the button to enable flicker scan.   video menu > [ Button Function] (P. 417)

## 3-9 Image Stabilization, Color, and Quality

The features described in this section reduce blur and noise compensate for the color of the light source. This section also covers picture mode options that can be used to control exactly how your pictures turn out.



### 3

#### Reducing Camera Blur

#### Image Stabilizer)

Reduce blur caused by the camera shake that commonly occurs, for example, when the subject is poorly lit or in photos taken at high zoom ratios. You will need to provide the lens focal length when using image stabilization with lenses that are not part of the Four Thirds or Micro Four Thirds family.

- This setting can be accessed via:
  - The LV super control panel (P. 377)
  - Live controls (P. 377)
  - The menus (P. 377)

<b>M-IS OFF</b> (off)	Image stabilization disabled.
<b>M-IS</b>  (omni-directional)	Electronic image stabilization combined with VCM-controlled image sensor movement.
<b>M-IS</b>  (omni-directional)	VCM-controlled image sensor movement only.

- Image stabilization may be unable to compensate for excessive camera motion. Use a tripod in these cases.
- You may notice noise or vibration while image stabilization is in effect.
- The setting selected with the lens image stabilization switch, if any, takes priority over that selected with the camera.

## ■ Access via the LV Super Control Panel

- 1 Highlight [Image Stabilizer] in the LV super control panel.

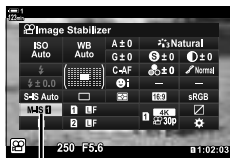
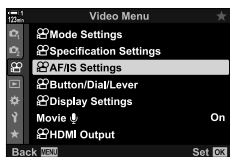

Image Stabilizer

- 2 Highlight an option using the front dial.
- 3 Press the shutter button halfway to select the highlighted option and exit the LV super control panel.

## ■ Menu Access

Choose an option using [AF/IS Settings] > [Image Stabilizer] in the video menu.



MENU button → tab → [AF/IS Settings] → [Image Stabilizer] → Use the  $\Delta$   $\nabla$  buttons to choose an option

## ■ Access via Live Controls

Highlight [Image Stabilizer] in the live controls and select an option using  $\triangleleft$   $\triangleright$  on the arrow pad.

- For information on displaying live controls, see “Using Live Controls” (P. 312).

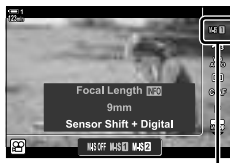

Image Stabilizer



## 🔍 Non-Four Thirds/Micro Four Thirds Lenses

When using lenses other than Micro Four Thirds or Four Thirds system lenses, you will need to specify the lens focal length. Press  $\triangleright$  on the arrow pad in the menu where you select an option, then use the  $\Delta$   $\nabla$   $\triangleleft$   $\triangleright$  buttons to highlight a value and press the **OK** button. If the lens information saved with [Lens Info Settings] (P. 550) is used, the saved focal length will be applied.





- Choose from values of from 0.1 mm to 1000.0 mm.
- Use the value printed on the lens.
- The selected value is not reset when you select [Reset / Custom Modes] (P. 91) > [Reset] (basic) in Shooting Menu 1.

Choose the amount of image stabilization applied.

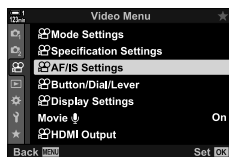
+1	Choose for static hand-held shots.
±0	Recommended in most situations.
-1	Choose for hand-held panning, tilting, or tracking shots.



- 1 Press the **MENU** button to display the menus.
- 2 Highlight [ AF/IS Settings] in the  video menu and press  on the arrow pad.

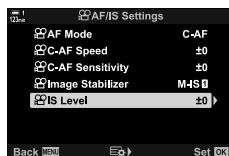

- 3 Highlight [ IS Level] using the   buttons and press the  button.



3

- 4 Highlight an option using the   buttons and press the **OK** button.

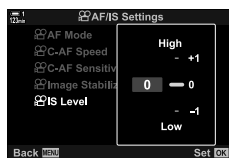









- 5 Press the **MENU** button repeatedly to exit the menus.

# High ISO Noise Reduction Options

## Noise Filter

Reduce image artifacts (“noise”) in footage filmed at high ISO sensitivities. This can help reduce “graininess” in footage filmed under low light. You can choose the amount of noise reduction performed.

<b>Off</b>	Noise reduction disabled.
<b>Low/Standard/High</b>	Choose the amount of noise reduction performed.



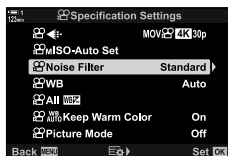
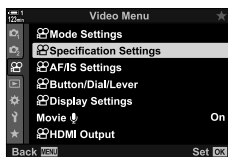





- 1 Press the **MENU** button to display the menus.
- 2 Highlight [ Specification Settings] in the  video menu and press  on the arrow pad.
- 3 Highlight [ Noise Filter] using the   buttons and press the  button.
- 4 Highlight an option using the   buttons and press the **OK** button.
- 5 Press the **MENU** button repeatedly to exit the menus.



3

White balance makes white objects look white. Although [AUTO] works well in most situations, you can choose an option suited to the light source if [AUTO] fails to make white objects appear white or if instead you wish to deliberately lend white objects a color cast.

- This setting can be accessed via:
  - The **WB** button (P. 381)
  - The LV super control panel (P. 382)
  - The menus (P. 382)
  - Live controls (P. 382)

White balance mode		Color temperature	Choose for
Auto white balance	<b>AUTO</b>	—	Most normal scenes (scenes containing objects that are white or close to white) <ul style="list-style-type: none"> <li>• This mode is recommended in most situations.</li> <li>• You can opt to preserve the colors seen under incandescent lighting (P. 383).</li> </ul>
Preset white balance		5300 K	Sunlit outdoor scenes, sunsets, fireworks
		7500 K	Daylight shots of subjects in the shade
		6000 K	Shots taken in daylight under overcast skies
		3000 K	Subjects under incandescent lighting
		4000 K	Subjects under fluorescent lighting
		—	Underwater photography
One touch white balance	<b>WB</b> 	5500 K	Light sources with the same color temperature as flash lighting
		Value selected for one-touch white balance	Situations in which you want to set white balance for a specific subject <ul style="list-style-type: none"> <li>• Color temperature is set to a value metered from a white object under the lighting what will be used in the final photograph (P. 386).</li> </ul>
Custom white balance	<b>CWB</b>	2000 K–14000 K	Situations in which you can identify the appropriate color temperature <ul style="list-style-type: none"> <li>• Choose a color temperature.</li> </ul>



## ■ Access via the WB Button

1 Press the **WB** button.

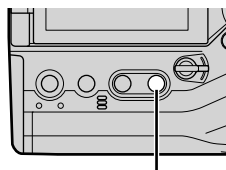

WB button

- [WB] options will be displayed.

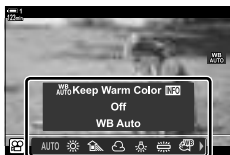

[WB] options

2 Rotate the front or rear dial to highlight an option.

- Pressing the **INFO** button when [AUTO] is highlighted displays [WB Keep Warm Color] options (P. 383).
- One-touch white balance (P. 386) and custom white balance options can be viewed by pressing the **INFO** button.
- You can also rotate the front or rear dial while pressing the **WB** button.

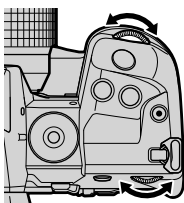

3 Press the shutter button halfway to select the highlighted option and exit.



- At default settings, white balance is assigned to the **WB** button. [WB] can however be assigned to other controls if desired. Use [Button/Dial/Lever] > [Button Function] (P. 417) in the video menu.

3

## ■ Access via the LV Super Control Panel

White balance can be selected using the LV super control panel.

**OK** button → [WB] → Use the front dial to choose an option

- To access [WB AUTO Keep Warm Color] options, press the **INFO** button after highlighting [AUTO] in the [WB] menu and pressing the **OK** button (P. 383).
- To choose a color temperature or measure a new value for white balance when one-touch (P. 386) or custom white balance is selected, press the **INFO** button after pressing the **OK** button and displaying the [WB] menu.
- When custom white balance ([CWB]) is selected, you can highlight the color temperature in the LV super control panel and choose a value by rotating the front dial.

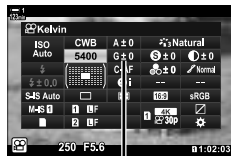

Color temperature

## ■ Menu Access

Adjust white balance using [Specification Settings] > [WB] in the video menu.

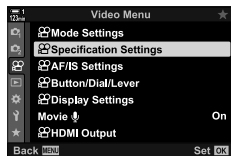

**MENU** button → [tab] → [Specification Settings] → [WB] → Use the  $\Delta$   $\nabla$  buttons to choose an option

## ■ Access via Live Controls

Highlight [WB] in the live controls and use  $\triangleleft$   $\triangleright$  on the arrow pad to choose an option.

- For information on displaying live controls, see "Using Live Controls" (P. 312).

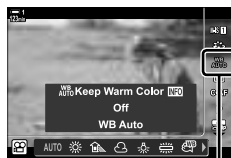

[WB]

# Preserving Warm Colors

## **WB AUTO Keep Warm Color**

If desired, auto white balance can be adjusted to preserve the warm colors seen under incandescent lighting. White balance would normally be adjusted to make white colors appear white, but this feature can be used to preserve the ambiance created by incandescent lighting.

- This setting can be accessed via:
  - The LV super control panel
  - The **WB** button
  - The menus
  - Live controls
- To access this option via the **WB** button, the LV super live control panel, or live controls, select [WB Auto] and press the **INFO** button.

### ■ Access via the LV Super Control Panel

- 1 Highlight  WB] in the LV super control panel and press the **OK** button.

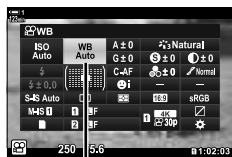

 white balance mode

3

- 2 Highlight [WB Auto] and press the **INFO** button.
  -  **WB AUTO Keep Warm Color**] options will be displayed.





- 3 Highlight [On] using  on the arrow pad and press the **OK** button.

### ■ Access via the WB Button

Select [WB Auto] ➔ **INFO** button ➔ Select [On]

### ■ Menu Access

**MENU** ➔  (video) menu ➔  Specification Settings] ➔ Select  **WB AUTO Keep Warm Color**] ➔ [On]

### ■ Access via Live Controls

Select [WB Auto] ➔ **INFO** button ➔ Select [On]

# White Balance Compensation

## (WB White Balance Compensation)

Fine-tune white balance. Separate values can be selected for each white balance option. Adjust settings as described below.

- This setting can be accessed via:
  - The LV super control panel
  - The menus

<b>A</b>	<b>A (amber–blue) axis</b>	Positive values add a red cast, negative values a blue cast.
<b>G</b>	<b>G (green–magenta) axis</b>	Positive values add a green cast, negative values a magenta cast.

### ■ Access via the LV Super Control Panel

- 1 Highlight [WB] in the LV super control panel and choose a white balance option.

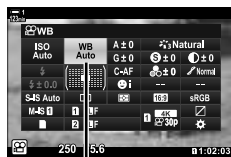

WB

- 2 Highlight [A±0] or [G±0] using the arrow pad ( $\Delta$   $\nabla$   $\triangleleft$   $\triangleright$ ) and highlight the desired value using the front dial.
  - To view a white balance compensation display, press the **OK** button. You can adjust white balance while previewing the results in the display. Use the front dial to select an axis (A or G) and the rear dial to choose a value.



White balance fine-tuning

- 3 Press the shutter button halfway to select the highlighted option and exit the LV super control panel.



- White balance fine-tuning can be applied simultaneously to all white balance options.  
 [WB] All [WB] (P. 385)

### ■ Menu Access

**MENU** button  $\Rightarrow$  [video] tab  $\Rightarrow$  [Specification Settings]  $\Rightarrow$  [WB]  $\Rightarrow$  Highlight a white balance option and press  $\triangleright$  on the arrow pad  $\Rightarrow$  Highlight A±0 or G±0 using the  $\triangleleft$  buttons and use the  $\Delta$   $\nabla$  buttons to choose a value (when [CWB] is selected, press the  $\triangleright$  button one more time and choose a value using the  $\Delta$   $\nabla$   $\triangleleft$   $\triangleright$  buttons)

Fine-tune white balance across the board. This item fine-tunes all modes by the same amount.

<b>All Set</b>	Fine-tune white balance for all modes. White balance can be fine-tuned on the A (amber–blue) and G (green–magenta) axes.
<b>All Reset</b>	Reset fine-tuning for all modes to default values.

- 1 Press the **MENU** button to display the menus.
- 2 Highlight [ Specification Settings] in the video menu and press **▶** on the arrow pad.

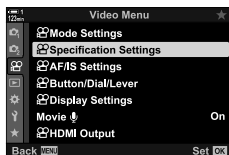

- 3 Highlight [ All ] using the **▲** **▼** buttons and press the **▶** button.

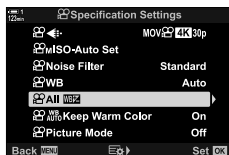



- 4 Highlight an option using the **▲** **▼** buttons and press the **▶** button.
  - If you selected [All Set] highlight A or G using the **◀▶** buttons, use the **▲** **▼** buttons to choose a value, and then press the **OK** button.
  - If you selected [All Reset], highlight [Yes] or [No] using the **▲** **▼** buttons and press the **OK** button.



- 5 Press the **MENU** button repeatedly to exit the menus.

## Metering White Balance

### (One-Touch White Balance )

Set white balance to a value measured under the lighting that will be used in the final photograph. Use this option to fine-tune white balance when you find it hard to obtain the desired results with white balance compensation or preset white balance options such as  (sunlight) or  (overcast). The camera stores the metered value for quick recall as required.

- This setting can be accessed via:
  - The **WB** button
  - The LV super control panel (P. 387)
  - Live controls (P. 387)
  - The menus (P. 387)

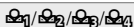

Measure and store up to four values for one-touch white balance.

### ■ Access via the WB Button

- 1 Press the **WB** button.

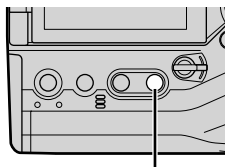

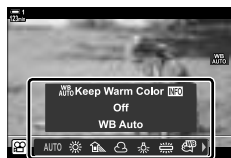

WB button

- [ WB] options will be displayed.



[ WB] options

- 2 Rotate the front or rear dial to highlight an option from  to .

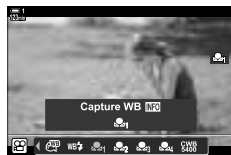

- 3 Frame a sheet of uncolored (white or gray) paper in the center of the display and press the **INFO** button.

- Be sure the subject is free of shadows.
- A confirmation dialog will be displayed.

#### 4 Highlight [Yes] using $\Delta$ / $\nabla$ on the arrow pad and press the **OK** button.

- The camera will store the setting as the value for the selected one-touch white balance option and exit to the shooting display.
- To exit without measuring white balance, highlight [No] and press the **OK** button. Repeat the process from Step 3.

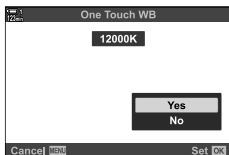

- You can also choose a setting by holding the **WB** button and rotating the rear dial. Release the button to select the setting and return to the shooting display.
- One-touch white balance can be assigned to a control. To do so, use [WB Button/Dial/Lever] > [WB Button Function] (P. 417).

#### ■ Access via the LV Super Control Panel

One-touch white balance can be selected using the LV super control panel.

[WB]  $\Rightarrow$  **OK** button  $\Rightarrow$  Highlight  $\odot_1$  to  $\odot_4$  using the front dial  $\Rightarrow$  **INFO** button  $\Rightarrow$  Meter white balance

#### ■ Access via Live Controls

One-touch white balance can be metered using live controls.

**OK** button  $\Rightarrow$  [WB]  $\Rightarrow$  Press  $\triangleleft$ / $\triangleright$  on the arrow pad and select any of  $\odot_1$  through  $\odot_4$

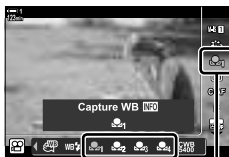

WB

3

- To view the white balance metering display and measure a new value for the currently-selected one-touch white balance option, press the **INFO** button.

#### ■ Menu Access











The menu can be used only to recall previously-metered values for one-touch white balance.

**MENU** button  $\Rightarrow$  [WB] tab  $\Rightarrow$  [Specification Settings]  $\Rightarrow$  [WB]  $\Rightarrow$  Select an option from  $\odot_1$  to  $\odot_4$  using  $\Delta$ / $\nabla$  on the arrow pad

Choose how pictures are processed during shooting to enhance color, tone, and other properties. Choose from preset picture modes according to your subject or artistic intent. You can also opt to make individual adjustments to parameters such as contrast and sharpness. Art filters similarly give you the option of adding frame effects and the like. Adjustments to individual parameters are stored separately for each picture mode.

- This item applies during both still photography and movie recording.

### Standard Picture Modes

 <b>i-Enhance</b>	The camera adjusts colors and contrast for optimal results according to the type of subject (P. 402).
 <b>Vivid</b>	Choose for vivid colors.
 <b>Natural</b>	Choose for natural colors.
 <b>Muted</b>	Choose for pictures that will later be retouched.
 <b>Portrait</b>	Enhance skin tones.
 <b>Monochrome</b>	Record pictures in monochrome. You can apply color filter effects and choose a tint (P. 400).
 <b>Custom</b>	Changes to selected picture modes can be saved for later recall as custom picture modes.
 <b>e-Portrait</b>	Enhance skin tones.
 <b>Underwater</b>	Process pictures to preserve the vivid colors seen under water.
 <b>Color Creator</b>	Adjust hue and color to suit your creative intent (P. 405).

### Art Filters

<b>ART 1</b> <b>Pop Art</b>	Enhance the beauty of colors.
<b>ART 2</b> <b>Soft Focus</b>	Use soft tones for an airy, dreamlike effect.
<b>ART 3</b> <b>Pale&amp;Light Color</b>	Diffuse light throughout the image, increasing exposure slightly and setting your subject adrift in a soft glow.
<b>ART 4</b> <b>Light Tone</b>	Soften highlights and shadows for a refined, serene effect.
<b>ART 5</b> <b>Grainy Film</b>	Choose for the forceful, bold effect typical of black-and-white film.
<b>ART 6</b> <b>Pin Hole</b>	Reduce peripheral illumination for the effect of a photo taken with an old toy camera.
<b>ART 7</b> <b>Diorama</b>	Increase saturation and contrast and blur out-of-focus areas to make the picture look like a photo of a miniature.
<b>ART 8</b> <b>Cross Process</b>	Choose for an edgy, surrealistic effect. Choose Cross Process II for a color balance that exaggerates magenta.



ART 9	<b>Gentle Sepia</b>	Choose for a peaceful, refined effect that softens the image overall, creating serene pictures with clearly-defined shadows.
ART 10	<b>Dramatic Tone</b>	Selectively enhance contrast to further differentiate light from dark.
ART 11	<b>Key Line</b>	Enhance edges for a photo-illustration effect.
ART 12	<b>Watercolor</b>	Dramatically brighten shadows to give the effect of a scene painted in bright pastel colors on white canvas, and add soft outlines for warm, bright results.
ART 13	<b>Vintage</b>	Mimic the effects of a discolored and faded vintage print for a nostalgic, slice-of-life effect.
ART 14	<b>Partial Color</b>	Enhance the impression created by your subject by recording only selected hues in color while the rest of the picture is in black-and-white.
ART 15	<b>Bleach Bypass</b>	The "bleach bypass" effect, which you may recognize from motion pictures and the like, can be used to great effect in shots of streetscapes or metal objects.
ART 16	<b>Instant Film</b>	A contemporary take on the shadow and skin tones typical of film.

- Depending on the scene, the effects of some settings may not be visible, while in other cases tone transitions may be ragged or the image rendered more "grainy".
- Depending on the settings selected, the effects may not be visible in live view.



- You can choose the picture modes displayed using [Picture Mode Settings] in Custom Menu **D1** (P. 520).
- You can also select a movie-only picture mode designed for movies that will be color-graded or otherwise processed during post-production. [Picture Mode] (P. 393)

## Choosing a Picture Mode

This setting can be accessed via:

- The LV super control panel
- The menus (P. 391)
- Live controls

### ■ Access via the LV Super Control Panel

1 Highlight [Picture Mode] in the LV super control panel.

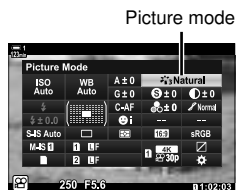

2 Highlight an option using the front dial.

- Depending on the option selected, picture mode parameters may be displayed in LV super control panel. Adjust parameters as desired (P. 396–402).

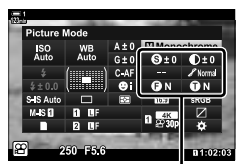

Changes depending on mode selected

3 Press the shutter button halfway to select the highlighted option and exit the LV super control panel.

### ■ Access via Live Controls

Picture mode can be accessed via live controls.



Picture mode

OK button → [Picture Mode] → Press <D> on the arrow pad to view options

- When [Color Creator] (P. 405) or the [Partial Color] art filter (P. 407) is selected, you can press the **INFO** button and adjust saturation and hue using the dials.

## ■ Menu Access

Use [Picture Mode] in Shooting Menu 1.

**MENU** button tab Use on the arrow pad to select Press the button to view picture mode parameters or filter effects

- You can adjust the individual parameters for each picture mode. You can also adjust parameters in the LV super control panel. Changes to parameters in the LV super control panel also apply to the menus.



Picture mode	Available parameters	
<b>i-Enhance</b>	[Sharpness]/[Contrast]/[Saturation]/[Gradation]/[Effect]	
<b>Vivid</b>	[Sharpness]/[Contrast]/[Saturation]/[Gradation]	
<b>Natural</b>		
<b>Muted</b>		
<b>Portrait</b>		
<b>Monochrome</b>		
<b>Custom</b>	[Sharpness]/[Contrast]/[Color Filter]/[Monochrome Color]/[Gradation]	
<b>e-Portrait</b>		
<b>Color Creator</b>		
<b>Underwater</b>		
<b>Pop Art</b>		
<b>Soft Focus</b>		
<b>Pale&amp;Light Color</b>		
<b>Light Tone</b>		
<b>Grainy Film</b>		
<b>Pin Hole</b>		[Add Effects]
<b>Diorama</b>		The options available vary with the filter selected.
<b>Cross Process</b>		[Soft Focus Effect]/[Pin Hole Effect]/[White Edge Effect]/[Frame Effect]/[Star Light Effect]*/[Blur Effect: Top and Bottom]/[Blur Effect: Left and Right]/[Shade Effect: Top and Bottom]/[Shade Effect: Left and Right]/[Color Filter]/[Monochrome Color]
<b>Gentle Sepia</b>		* Has no effect in  (movie) mode.
<b>Dramatic Tone</b>		
<b>Key Line</b>		
<b>Watercolor</b>		
<b>Vintage</b>		
<b>Partial Color</b>		
<b>Bleach Bypass</b>		
<b>Instant Film</b>		

- Select (custom) to access the parameters for saved picture modes.



## Creating Custom Picture Modes (C Custom Picture Mode)

You can select one of the following picture modes, edit its parameters as desired, and save it as a custom picture mode.





Choose from [i-Enhance], [Vivid], [Natural], [Muted], [Portrait], and [Monochrome].

- 1 Press the **MENU** button to display the menus.
- 2 Highlight [Picture Mode] in  Shooting Menu 1 and press  on the arrow pad.

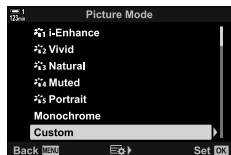

- 3 Highlight [Custom] using the   buttons and press the  button.
  - The camera will display a list of picture modes.



- 4 Adjust settings using the   buttons.
  - Choose a [Picture Mode] mode option and adjust [Sharpness], [Contrast], [Saturation], [Gradation], [Effect], [Color Filter], and [Monochrome Color] parameters.
  - Highlight parameters using the   buttons and press the  button to view settings. After adjusting settings, press the **OK** button repeatedly to return to the parameter list.

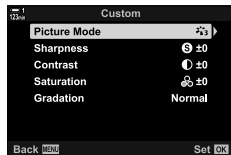



- 5 Press the **MENU** button repeatedly to exit the menus.

# Highlight&Shadow Control

## Picture Mode)

Choose a picture mode exclusively for movie recording. Priority is given to dynamic range for a tone curve suitable for color grading and other post-processing operations. These options are available for [Picture Mode] when [On] is selected for  Picture Mode].







- This setting can be accessed via:
  - The menus
  - The LV super control panel (P. 394)
  - Live controls (P. 394)

 <b>Flat</b>	Movies are recorded using a tone curve adapted to color grading.
 <b>OM-Log400</b>	Movies are recorded using a log tone curve for greater freedom during color grading.

- [Sharpness], [Contrast], [Saturation], and [Gradation] options are unavailable.
-  ISO] is restricted to values of ISO 400 or above.

### ■ Menu Access

To use these picture mode options, enable  Picture Mode], which changes the options available in the [Picture Mode] menu.

- 1 Press the **MENU** button to display the menus.
- 2 Highlight  Specification Settings] in the  video menu and press  on the arrow pad.
- 3 Highlight  Picture Mode] using the   buttons and press the  button.

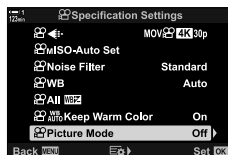
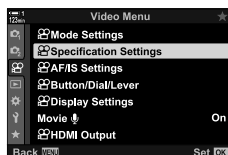

- 4 Highlight [On] using the  $\Delta$   $\nabla$  buttons and press the OK button.



- 5 Press the **MENU** button repeatedly to exit the menus.
- 6 Select [ $\text{Flat}$ ] or [ $\text{OM-Log400}$ ] for [Picture Mode] in  $\text{Shooting Menu 1}$ .

### ■ Access via the LV Super Control Panel

Movie picture mode options are available in the LV super control panel when [On] is selected for [ $\text{Picture Mode}$ ].

- 1 Highlight [Picture Mode] in the LV super control panel.

Picture mode

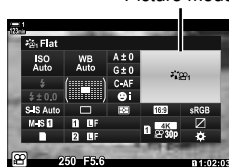

- 2 Select an option using the front dial.
- Choose [ $\text{Flat}$ ] or [ $\text{OM-Log400}$ ].

### ■ Access via Live Controls

Picture mode can be selected using live controls.

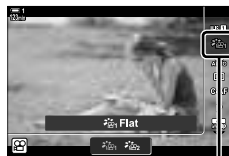

Picture mode



OK button  $\rightarrow$  [Picture Mode]  $\rightarrow$  Press  $\triangleleft$   $\triangleright$  on the arrow pad to choose an option





- LUT files are available for editing movies recorded using movie-only picture modes. Visit the OLYMPUS website for details.

# Preview Options for Movie Picture Modes





## ( View Assist)

The display can be adjusted for ease of viewing when a movie-only picture mode option ([ Flat] or [ OM-Log400]) is selected.

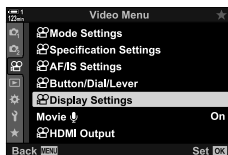

<b>On</b>	Adjust the picture for ease of viewing. The indicators in the display may change color.
<b>Off</b>	Do not adjust the picture for ease of viewing.

- 1 Press the **MENU** button to display the menus.
- 2 Highlight [ Display Settings] in the  video menu and press  on the arrow pad.



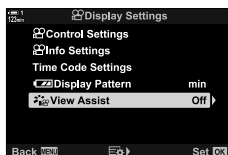

- 3 Highlight [ View Assist] using the   buttons and press the  button.

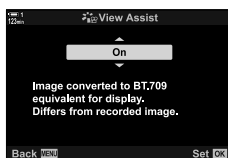

- 4 Highlight an option using the   buttons and press the **OK** button.



- 5 Press the **MENU** button repeatedly to exit the menus.
- This option applies only to the display, not to the actual movie files.
  - This option does not apply when movies recorded using [ Flat] or [ OM-Log400] are played back on the camera. It also does not apply when the movies are viewed on a TV.

3

Adjust image sharpness. Outlines can be emphasized for a sharp, clear picture. Settings are stored separately for each picture mode.

- This setting can be accessed via:
  - The LV super control panel
  - The menus

Hi (+)	Increase sharpness. Outlines are more sharply defined.
Lo (-)	Lower sharpness. Outlines are less sharply defined.

## ■ Access via the LV Super Control Panel

- 1 Highlight [Sharpness] in the LV super control panel.

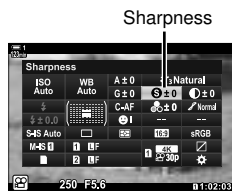

- 2 Highlight an option using the front dial.
- 3 Press the shutter button halfway to select the highlighted option and exit the LV super control panel.

## ■ Menu Access

Adjust sharpness using [Picture Mode] in  Shooting Menu 1.

**MENU** button  $\Rightarrow$   (Shooting Menu 1) tab  $\Rightarrow$  [Picture Mode]  $\Rightarrow$  Highlight a picture mode using  $\Delta$ / $\nabla$  on the arrow pad and press the  $\triangleright$  button  $\Rightarrow$  Highlight [Sharpness] using the  $\Delta$ / $\nabla$  buttons and press the  $\triangleright$  button  $\Rightarrow$  Use the  $\Delta$ / $\nabla$  buttons to choose an option



Adjust image contrast. Increasing contrast heightens the difference between bright and dark areas for a harder, more well-defined picture. Settings are stored separately for each picture mode.

- This setting can be accessed via:
  - The LV super control panel
  - The menus

<b>Hi (+)</b>	Increase contrast. Pictures are harder and more well-defined.
<b>Lo (-)</b>	Lower contrast. Pictures are softer.

## ■ Access via the LV Super Control Panel

- 1 Highlight [Contrast] in the LV super control panel.

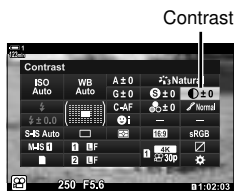

- 2 Highlight an option using the front dial.
- 3 Press the shutter button halfway to select the highlighted option and exit the LV super control panel.

## ■ Menu Access

Adjust contrast using [Picture Mode] in Shooting Menu 1.

**MENU** button (Shooting Menu 1) tab [Picture Mode] Highlight a picture mode using  $\Delta$   $\nabla$  on the arrow pad and press the  $\triangleright$  button Highlight [Contrast] using the  $\Delta$   $\nabla$  buttons and press the  $\triangleright$  button Use the  $\Delta$   $\nabla$  buttons to choose an option

Adjust color saturation. Increasing saturation makes pictures more vivid. Settings are stored separately for each picture mode.

- This setting can be accessed via:
  - The LV super control panel
  - The menus

Hi (+)	Increase saturation. Colors are more vivid.
Lo (-)	Lower saturation. Colors are softer.

## ■ Access via the LV Super Control Panel



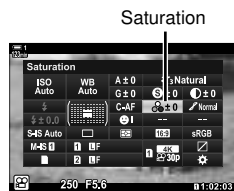









- 1 Highlight [Saturation] in the LV super control panel.



- 2 Highlight an option using the front dial.
- 3 Press the shutter button halfway to select the highlighted option and exit the LV super control panel.

## ■ Menu Access

Adjust saturation using [Picture Mode] in  Shooting Menu 1.

**MENU** button  (Shooting Menu 1) tab  [Picture Mode]  Highlight an item using   on the arrow pad and press the  button  Highlight [Saturation] using the   buttons and press the  button  Use the   buttons to choose an option

Adjust color brightness and shading. Bring pictures closer to what you envisage by, for example, brightening the entire picture. You can also heighten dark tones or light tones as appropriate to the distribution of tones in the original image. Settings are stored separately for each picture mode.

- This setting can be accessed via:
  - The LV super control panel
  - The menus

<b>Auto</b> (Shadow Adj)	Brightness is adjusted separately for every detail. A good choice for high-contrast images where shadows or highlights might otherwise be lost.
<b>Normal</b> (Gradation Normal)	Optimal shading. Recommended in most circumstances.

## ■ Access via the LV Super Control Panel

- 1 Highlight [Gradation] in the LV super control panel.

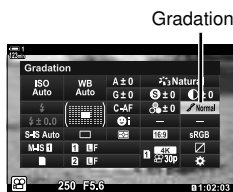

- 2 Highlight an option using the front dial.
- 3 Press the shutter button halfway to select the highlighted option and exit the LV super control panel.

## ■ Menu Access

Adjust shading using [Picture Mode] in Shooting Menu 1.

**MENU** button  $\Rightarrow$  (Shooting Menu 1) tab  $\Rightarrow$  [Picture Mode]  $\Rightarrow$  Highlight a picture mode using  $\Delta$   $\nabla$  on the arrow pad and press the  $\triangleright$  button  $\Rightarrow$  Highlight [Gradation] using the  $\Delta$   $\nabla$  buttons and press the  $\triangleright$  button  $\Rightarrow$  Use the  $\Delta$   $\nabla$  buttons to choose an option

# Color Filters for Black-and-White Photography (Color Filter)

Filter effects can be added when [Monochrome] is selected for picture mode (P. 388). You can brighten subjects or enhance contrast according to the original color of the subject. Orange adds more contrast than yellow, red more contrast than orange. Green is a good choice for portraits and the like.

- This setting can be accessed via:
  - The LV super control panel
  - The menus

<b>N:None</b>	No filter effect.
<b>Ye:Yellow</b>	White clouds stand out clearly against natural-looking skies.
<b>Or:Orange</b>	Slightly brings out blue skies or the light of the setting sun.
<b>R:Red</b>	Further brings out blue skies or autumn foliage.
<b>G:Green</b>	Adds warmth to skin tones in portraits. The green filter also emphasizes the reds in lipstick.

## ■ Access via the LV Super Control Panel

This option is available when [Monochrome] is selected for [Picture Mode].

- 3** 1 Highlight [Color Filter] in the LV super control panel.

Color filter



- 2** Highlight an option using the front dial.
- 3** Press the shutter button halfway to select the highlighted option and exit the LV super control panel.

## ■ Menu Access

Choose a filter using [Picture Mode] in Shooting Menu 1.

**MENU** button → (Shooting Menu 1) tab → [Picture Mode] → Highlight [Monochrome] using  $\Delta$ / $\nabla$  on the arrow pad and press the  $\triangleright$  button → Highlight [Color Filter] using the  $\Delta$ / $\nabla$  buttons and press the  $\triangleright$  button → Use the  $\Delta$ / $\nabla$  buttons to choose an option

Add a tint to black-and-white pictures in the [Monochrome] picture mode (P. 388).

- This setting can be accessed via:
  - The LV super control panel
  - The menus

<b>N:Normal</b>	Shoot in black and white.
<b>S:Sepia</b>	Shoot in sepia-tinted monochrome.
<b>B:Blue</b>	Shoot in blue-tinted monochrome.
<b>P:Purple</b>	Shoot in purple-tinted monochrome.
<b>G:Green</b>	Shoot in green-tinted monochrome.

## ■ Access via the LV Super Control Panel

This option is available when [Monochrome] is selected for [Picture Mode].

- 1 Highlight [Monochrome Color] in the LV super control panel.

Monochrome color

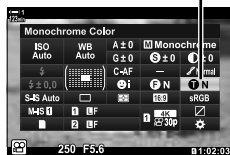

- 2 Highlight an option using the front dial.
- 3 Press the shutter button halfway to select the highlighted option and exit the LV super control panel.

## ■ Menu Access

Choose a tint using [Picture Mode] in Shooting Menu 1.

**MENU** button → (Shooting Menu 1) tab → [Picture Mode] → Highlight [Monochrome] using  $\Delta$   $\nabla$  on the arrow pad and press the  $\triangleright$  button → Highlight [Monochrome Color] using the  $\Delta$   $\nabla$  buttons and press the  $\triangleright$  button → Use the  $\Delta$   $\nabla$  buttons to choose an option

Choose the strength of the effect for [i-Enhance].

- This setting can be accessed via:
  - The LV super control panel
  - The menus

<b>Low (Effect: Low)</b>	Effect reduced.
<b>Standard (Effect: Standard)</b>	Standard effect.
<b>High (Effect: High)</b>	Effect heightened.

### Access via the LV Super Control Panel

This option is available when [i-Enhance] is selected for [Picture Mode].

- Highlight [Effect] in the LV super control panel.

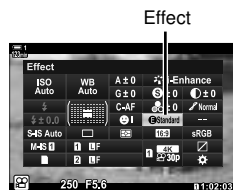

- Highlight an option using the front dial.
- Press the shutter button halfway to select the highlighted option and exit the LV super control panel.

### Menu Access

Choose the strength of the effect using [Picture Mode] in Shooting Menu 1.

**MENU** button → (Shooting Menu 1) tab → [Picture Mode] → Highlight [i-Enhance] using  $\Delta$ / $\nabla$  on the arrow pad and press the  $\triangleright$  button → Highlight [Effect] using the  $\Delta$ / $\nabla$  buttons and press the  $\triangleright$  button → Use the  $\Delta$ / $\nabla$  buttons to choose an option

# Choosing a Tone Curve

## (Highlight&Shadow Control)

Adjust brightness separately for highlights, mid-tones, and shadows. You gain greater control over exposure than you would with exposure compensation alone. You can selectively make highlights darker or shadows brighter.

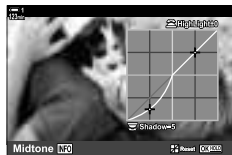

Adjusting shadows



Adjusting mid-tones

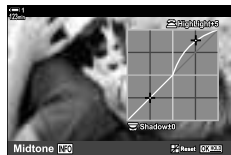

Adjusting highlights

(The illustrations above show the display when the highlight and shadow control is accessed via a button and the LV super control panel.)

- This setting can be accessed via:
  - The  button
  - The LV super control panel (P. 404)

### ■ Access via the Button

- 1 Press the  button.
  - Exposure compensation will be highlighted in the display.

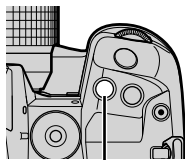



 button

- 2 Press the **INFO** button.
  - A tone curve will be displayed.
  - Press the **INFO** button to cycle from shadows to mid-tones to highlights and back to exposure compensation again.



 (Highlight and shadow control)

- 3 Select the desired setting using   on the arrow pad.
  - Choose from values between -7 and +7.
  - Press and hold the **OK** button to reset the curve.

- 4** Press the **OK** button to save changes.
- You can also save changes by pressing the shutter button halfway.



- Exposure compensation, and with it highlight and shadow control, can be assigned to controls other than the **Fn** button. Use [**Fn** Button/Dial/Lever] > [**Fn** Button Function] (P. 417) in the **Fn** video menu.
- Assigning [Multi Function] to the control gives you direct access to [Highlight&Shadow Control]. **Fn** "Multi-Function Button Options (Multi Function)" (P. 470)

## ■ Access via the LV Super Control Panel

- 1** Highlight [Highlight&Shadow Control] in the LV super control panel and press the **OK** button.
- A tone curve will be displayed.



Highlight&Shadow Control

- 2** Press the **INFO** button to choose the desired tone range.
- The tone range changes each time the button is pressed.

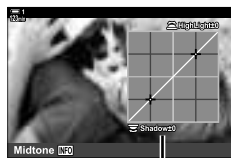

Selected tone range

- 3** Rotate the dials to choose the desired setting.
- [Hi. & Sh.] selected**  
Adjust highlights using the front dial and shadows using the rear dial.
  - [Midtone] selected**  
Use the front or rear dial.
  - Press and hold the **OK** button to restore the default curve.



- 4** Press the **OK** button to save changes.
- You can also save changes by pressing the shutter button halfway.



The camera permits intuitive adjustments to color saturation and hue. Choose from 30 hues and 8 levels of saturation. The results can be previewed in the display.

[Color Creator] is a picture mode option. Settings can be accessed directly using [Multi Function]. Assign [Multi Function] to a button using [Multi Function] > [Multi Function] (P. 417) in the [Multi Function] video menu.

- This setting can be accessed via:
  - The LV super control panel
  - Live controls (P. 406)
  - The menus (P. 406)

## ■ Access via the LV Super Control Panel

- 1 Highlight [Picture Mode] in the LV super control panel.

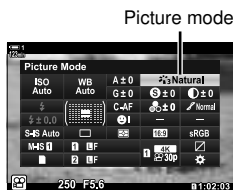

- 2 Highlight [Color Creator] using the front dial.
  - A [Color/Vivid] option will be displayed in the LV super control panel.

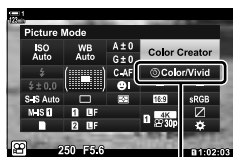

Color/Vivid

- 3 Highlight [Color/Vivid] using  $\Delta$   $\nabla$  on the arrow pad and press the **OK** button.

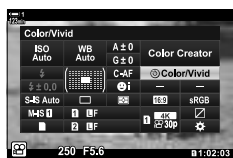

- 4 Adjust saturation and hue.
  - Rotate the front dial to adjust hue.
  - Rotate the rear dial to adjust saturation.
  - Press and hold the **OK** button to restore default settings.



- 5** Press the **OK** button to save changes.
- You can also save changes by pressing the shutter button halfway.

### ■ Menu Access

The color creator can also be accessed via the menus. Saturation and hue, however, cannot be adjusted via the menus. The menus can be used to recall saved values only.

**MENU** button →  (Shooting Menu 1) tab → [Picture Mode] → [Color Creator] → Press  $\Delta$   $\nabla$  on the arrow pad to choose options

### ■ Access via Live Controls

The color creator can be accessed using live controls.



Picture Mode

**3**

**OK** button → [Picture Mode] → Press  $\triangleright$  on the arrow pad to highlight [Color Creator]  
→ Press the **INFO** button and adjust saturation and hue

Shoot in black-and-white while capturing objects of a selected hue in color. For example, you can shoot in black-and-white while leaving only reds in color. The results can be previewed in the display.

[Partial Color] is an art filter option. Settings can be adjusted when it is selected for picture mode. Choose from three “leave color” filters (I through III).

- 1 Highlight [Picture Mode] in the LV super control panel.

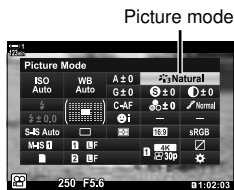

- 2 Highlight [ART14 I], [ART14 II], or [ART14 III] using the front dial.
  - A [Color] and [Effect] options will be displayed in the LV super control panel.

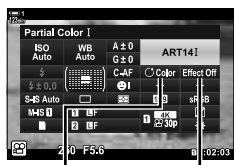

3

- 3 Highlight [Color] using  $\Delta$   $\nabla$  on the arrow pad and press the **OK** button.
  - A color ring will be displayed.

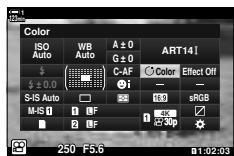

- 4 Select a color using the dials.
- 5 Press the **OK** button to save changes.
  - You can also save changes by pressing the shutter button halfway.

## 3-10 Effects



The camera offers simple effects that can be added during filming. Instead of waiting to edit the movie on a computer or other device, you can view the effects in real time while recording is in progress. Some effects can be saved to display settings or direct buttons.

### Power Zoom

### ( Elec. Zoom Speed)



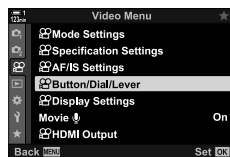

Choose the zoom speed for power zoom lenses. This can be used for slow zooms on your subject and other effects. Choose from [Low], [Normal], and [High].

1 Press the **MENU** button to display the menus.



2 Highlight [ Button/Dial/Lever] in the  video menu and press  on the arrow pad.



3

3 Highlight [ Elec. Zoom Speed] using the   buttons and press the  button.





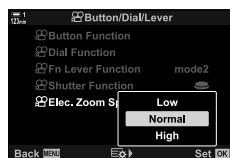

4 Highlight the desired option using the   buttons and press the **OK** button.















5 Press the **MENU** button repeatedly to exit the menus.

You can zoom in on a selected area of the frame for movie recording without using lens controls. Use for instant close-ups or cuts to wider angle. Buttons or touch controls can be used to choose the zoom location and cut to close ups or wide angles during filming.

[Movie ] is a [ Button Function] option. It turns on or off with a button and so must be assigned to a control using [ Button Function] (P. 417).







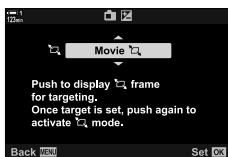
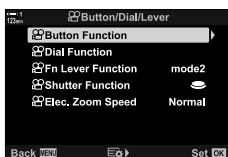
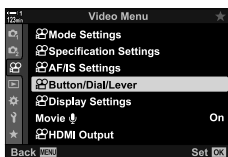

- This feature is not available when [4K] or [C4K] is selected for [ ←] > [Movie Resolution].
- This feature cannot be used to film high-speed movies.
- [Movie ] cannot be combined with [Digital Tele-converter] (P. 411).

## ■ Button Access

- 1 Press the **MENU** button to display the menus.
- 2 Highlight [ Button/Dial/Lever] in the  video menu and press  on the arrow pad.
- 3 Highlight [ Button Function] using the   buttons and press the  button.
- 4 Using the   buttons, highlight the control you want to use for digital zoom and press the  button.
- 5 Highlight [Movie ] using the   buttons and press the **OK** button.
- 6 Press the **MENU** button repeatedly to exit the menus.



## ■ Using [Movie ]

- 1 Press the button to which [] is assigned.
  - A frame will appear in the center of the display.
- 2 Position the frame as desired.
  - Position the frame using touch controls, the multi selector, or the arrow pad (   ).
  - To re-center the frame, press the multi selector once or press and hold the **OK** button.
- 3 Press the button to which [] is assigned once more.
  - The camera will zoom the selected area in to fill the display.
  - To return to the zoom frame, press the button to which [] is assigned a third time.
- 3 4 To end zoom, press the **OK** button once, or press and hold the button to which [] is assigned.

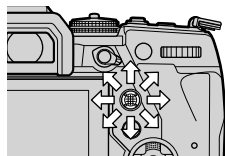





Multi selector

## Filming at a Higher Zoom Ratio (Digital Tele-converter)

This option takes a crop at the center of the frame the same dimensions as the size option currently selected for image quality and zooms it in to fill the display. The zoom ratio increases by about 2x. This allows you to zoom in past the lens' maximum focal length, making it a good choice when you are unable to switch lenses or find it difficult to get any closer to your subject.

- [Digital Tele-converter] cannot be combined with [Movie ] (P. 409).
- The digital teleconverter cannot be turned on or off while movie recording is in progress.

- 1 Press the **MENU** button to display the menus.
- 2 Highlight [Digital Tele-converter] in  Shooting Menu 1 and press  on the arrow pad.
- 3 Highlight [On] using the   buttons and press the **OK** button.





- When [On] is selected, the display in the monitor is zoomed in by 2x and  appears in the display. Movies are recorded at this zoom ratio.

Digital teleconverter



- 4 Press the **MENU** button repeatedly to exit the menus.



- [Digital Tele-converter] can be assigned to a camera control using [ Button/Dial/Lever] > [ Button Function] (P. 417) in the  video menu, allowing you to turn it on or off and the touch of a button.







## 3-11 Audio Recording



The camera is equipped with a microphone. The camera by itself is equal to the task of recording movies with sound. You can adjust the recording level and use features such as wind noise reduction. There are also microphone and headphone options for use that can be employed for high-level cinematography using an external recorder.





If desired, the optional Olympus IC recorder (LS-100) can be used in tandem with the camera to record sound.







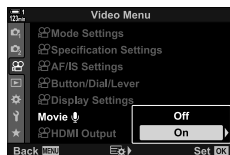
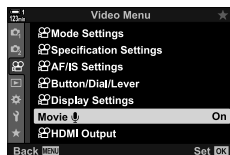

Adjust settings for recording sound during filming. You can also access settings for use when an external microphone or recorder is connected.

<b>Recording Volume</b>	Adjust microphone sensitivity. Choose separate values for the built-in and external microphones. [Built-In  ]: Adjust the sensitivity of the built-in microphone. [MIC  ]: Adjust the sensitivity of external microphones connected to the microphone jack.
 <b>Volume Limiter</b>	Choose the maximum volume at which the camera will record sound. Use this option to automatically reduce the level of sounds above a certain volume.
<b>Wind Noise Reduction</b>	Reduce wind noise during audio recording.
<b>Recording Rate</b>	Choose an audio recording format. [96kHz/24bit]: High-quality audio. [48kHz/16bit]: Standard-quality audio.
 <b>Plug-in Power</b>	Adjust settings for use with condenser microphones and other devices that draw power from the camera. [Off]: For devices that do not require power from the camera (general-purpose dynamic microphones). [On]: For devices that require power from the camera (condenser microphones).
<b>PCM Recorder  Link</b>	Adjust settings for use with external IC recorders. Record a slate tone or choose whether camera controls can be used to start and stop recording when using an Olympus LS-100 IC recorder. [Camera Rec. Volume]: Choose [Operative] to record sound at the level selected with the camera, [Inoperative] to record sound at the level selected with the recorder. [Slate Tone]: Enable or disable slate tone recording. [Synchronized  Rec.]: Choose whether audio recording begins and ends at the same time as movie recording.
<b>Headphone Volume</b>	Adjust the volume of audio output to the headphones.

- Sounds made by the lens or camera controls may be recorded during filming. For reduced noise, select [S-AF], [MF], or [PreMF] for [ AF Mode] (P. 345) and use camera controls as little as possible.
- Sound is not recorded:
  - with high-speed or slow- or fast-motion movies or when <sup>ART</sup> (diorama) is selected for picture mode.
-  is displayed when [Off] is selected.
- Audio can only be played on devices that support the option selected for [Recording Rate].

- 1 Press the **MENU** button to display the menus.
- 2 Highlight [Movie] in the  video menu and press  on the arrow pad.
- 3 Highlight [On] using the   buttons and press the  button.
  - Movie audio recording options will be displayed.





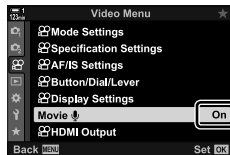

- 4 Highlight the desired option using the   buttons and press the  button.
  - The following options are available:
    - [Recording Volume]: Select [Built-In] or [MIC] and choose the recording level.
    - [Volume Limiter]: Select [Off] or [On].
    - [Wind Noise Reduction]: Choose from [Off], [Low], [Normal], and [High].
    - [Recording Rate]: Choose from [96kHz/24bit] and [48kHz/16bit].
    - [Plug-in Power]: Select [Off] or [On].
    - [PCM Recorder Link]: Adjust settings as desired (P. 413).
    - [Headphone Volume]: Choose from settings between 16 and 1.
  - Press the **OK** button to return to the  Audio Record Settings] menu after choosing a setting for each option.
- 5 Press the **OK** button when settings are complete.
  - Press the **OK** button repeatedly to return to the  video menu. Confirm that [On] is selected for [Movie].



- 6 Press the **MENU** button to exit the menus.



- Silent controls can be used to adjust the recording level during filming.  “Touch Controls (Silent Controls)” (P. 306)
- If the **Fn** lever is configured to allow the dials to be used to change camera settings, [Recording Volume] and [Headphone Volume] can be adjusted using the dials. The recording level can then be changed during filming.   [Fn Lever Function] (P. 426),  [Dial Function] (P. 424)

# Using the Olympus LS-100 IC Recorder

When recording audio with an Olympus LS-100 IC recorder, you can use camera controls to record slate tones or to start and stop recording.

Connect the LS-100 using the USB cable and a third-party stereo mini-jack cable. Use a “no resistance” cable.

- Additional information is available in the documentation provided with the LS-100. Be sure the recorder firmware has been updated to the latest version.

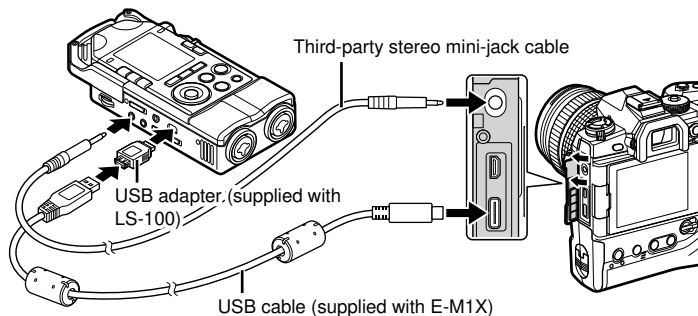

## 1 Connect the IC recorder.

- When the LS-100 is connected via USB, a message will be displayed prompting you to choose a connection type. Select [PCM Recorder].
- If no message is displayed, adjust menu settings as follows:  
**MENU** button ➔ **⚙** (custom menu) tab ➔ **DA** tab ➔ [USB Mode] ➔ Select [Auto] or [PCM Recorder]



3

## 2 Adjust [PCM Recorder Link] settings:

- **MENU** button ➔  (video) menu ➔ [Movie ] ➔ [On] ➔ Press **▶** on the arrow pad

[Camera Rec. Volume]: Select [Inoperative].

[Slate Tone]: Select [On].

[Synchronized  Rec.]: Select [On].



After adjusting settings, check that [On] is selected for [Movie ] and press the **MENU** button repeatedly to exit the menus.

### 3 Start filming.

- The LS-100 will begin recording audio.
- To record a slate tone, press and hold the **OK** button.

### 4 End filming.

- The LS-100 will stop recording audio.



- You can choose how long you have to keep the button pressed to record a slate tone.  
 [Press-and-hold Time] (P. 558)
- Disconnect the USB cable when the camera is off or the recorder is not in use.



## 3-12 Customizing Camera Controls

The camera is equipped with “direct” buttons that can be used for direct adjustments to settings such as ISO sensitivity and white balance, and controls such as the dials and **Fn** lever that can be assigned different roles. These controls can be customized for ease of use. Buttons can be assigned movie-related functions for access during filming.

3









### Assigning Roles to Buttons (Movie Button Function)

Other roles can be assigned to buttons in place of their existing roles. Menu items and the like can be assigned to buttons for quick access during movie recording.

The functions assigned to controls using this item are available only in  (movie) mode. The functions assigned in the  custom menu take effect in modes **P**, **A**, **S**, **M**, and **B** (still photography modes).

- This setting can be accessed via:
  - The LV super control panel (P. 421)
  - The menus (P. 422)

#### Customizable Controls

Icon	Button (orientation)	Default role
	 (exposure compensation) button	Exposure compensation
	ISO button	ISO sensitivity
	 (movie) button	Movie recording
	 (LV) button	Display selection
	Fn button	AF-target mode

























Icon	Button (orientation)	Default role
	<b>AEL/AFL</b> button	Exposure lock
	<b>WB</b> button	White balance
	Arrow pad	AF-target selection
	Arrow pad ▷ (right) *	Off ( <b>W↔T</b> )
	Arrow pad ▽ (down) *	Off ( <b>WB</b> )
	One-touch white balance button	Focus peaking
	Preview button	Zoom
	Vertical-use  (exposure compensation) button	Off
	Vertical-use <b>ISO</b> button	Off
	Vertical-use <b>AEL/AFL</b> button	Off
	Vertical-use one-touch white balance button	Off
	Vertical-use preview button	Off
	<b>L-Fn</b> (lens focus function buttons)	Lens <b>Fn</b> buttons (autofocus stop)







\* To use ▷ and ▽ on the arrow pad in their assigned roles, select [Direct Function] for (arrow pad).

### 3

#### Available Roles

Role	Function
<b>AF Stop</b>	Suspend autofocus. Focus locks and autofocus is suspended while the control is pressed. Applies only to lens <b>L-Fn</b> buttons.
<b>AEL/AFL</b> ()	Lock exposure. Press once to lock exposure; exposure remains locked until the button is pressed a second time.
<b>REC</b> (movie recording)	The control functions as a movie-record button. Press to start or stop recording.
<b>Direct Function</b> ()	Assign roles to the buttons on the arrow pad (△ ▽ ◀ ▶). The following roles can be assigned: ◀ button: <b>[:::]</b> (AF-target selection) △ button:  (exposure compensation) ▶ button: <b>W↔T</b> (power zoom) ▽ button: <b>WB</b> (white balance) • Use  and  to assign roles respectively to the ▶ and ▽ buttons.

Role	Function
<b>AF Area Select</b> (::::)]	Adjust AF-target settings. You can choose the AF-target mode (P. 349) and position (P. 352) and adjust settings for face-detection AF (P. 360). Press the control to view the AF-target selection display. Use the front or rear dial to choose AF-target mode and face-detection settings and the multi selector or arrow pad to position the AF target.
 <b>Lock</b> (touch control lock)	Lock touch controls. Press and hold the button once to lock touch controls and again to unlock. The  and  buttons must first be assigned a function using [Direct Function].
<b>Electronic Zoom</b> (W↔T)	Zoom power zoom lenses in or out. After pressing the control, use the arrow pad to zoom in or out. Use  or  on the arrow pad to zoom in and  or  to zoom out. The  and  buttons must first be assigned a function using [Direct Function].
<b>MF</b> (AF/MF toggle)	Switch between AF and MF. Press once to select MF and again to return to the previous mode. The focus mode can also be selected by holding the button and rotating a dial. You can switch between AF and MF during filming. This option is unable when [mode2] is selected for  Fn Lever Function].
<b>Exposure</b>  (  )	Adjust exposure settings. Hold the control and rotate the front or rear dial. Alternatively, you can press the button to activate settings and then rotate the dials. The adjustments available vary with the movie exposure mode: [P]: Use the front or rear dial or  on the arrow pad for exposure compensation. [A]: Use the front or rear dial or  on the arrow pad for exposure compensation. Use the   buttons for aperture. [S]: Use the front or rear dial or  on the arrow pad for exposure compensation. Use the   buttons for shutter speed. [M]: Hold the button and adjust exposure compensation using the front or rear dial.
<b>Digital Tele-converter</b> (  )	Turn the digital teleconverter on or off (P. 411). Press once to zoom in and again to zoom out.
<b>Movie</b>  (  )	Zoom in or out using the movie teleconverter (P. 409). Press the control once to display the zoom frame and again to zoom in. Press the control a third time to exit zoom; to hide the zoom frame, press and hold the control. Use the multi selector, touch controls, or the arrow pad (    ) to position the zoom frame.

Role	Function
<b>Magnify</b> (Q)	Focus on the subject in the zoom frame (P. 364). Press the control once to display the zoom frame and again to zoom in. Press the control a third time to exit zoom; to hide the zoom frame, press and hold the control. Use the multi selector, touch controls, or the arrow pad (△ ▽ ◀ ▶) to position the zoom frame.
<b>ISO</b>	Adjust [ISO] settings (P. 369). Hold the control and rotate the front or rear dial. Alternatively, you can press the button to activate settings and then rotate the dials. Use the front or rear dial or ◀ ▶ on the arrow pad to adjust settings.
<b>WB</b> (white balance)	Adjust [WB] settings (P. 380). Hold the control and rotate the front or rear dial. Alternatively, you can press the button to activate settings and then rotate the dials. Use the front or rear dial or ◀ ▶ on the arrow pad to adjust settings.
 (one-touch white balance)	Measure a value for one-touch white balance (P. 386). Frame a piece of white paper or other reference object in the display and press the control. Select a destination for the new value when prompted.
<b>Multi Fn</b> (multi Function)	Configure the control for use as a multi-function button (P. 470). Hold the control and rotate the front or rear dial to choose the function performed. The selected function can be performed by pressing the control.
<b>Peaking</b> (PEAK)	Toggle focus peaking on or off (P. 525). Press the control once to turn peaking on and again to turn it off. When peaking is on, peaking options (color, amount) can be displayed by pressing the <b>INFO</b> button.
 <b>Level Disp</b> (  )	Display the digital level gauge. The exposure bar display in the viewfinder functions as a level gauge. This option takes effect when [Style 1] or [Style 2] is selected for [EVF Style] in  Custom Menu <b>1</b> .
 <b>View Selection</b> (display selection)	Switch between the monitor and viewfinder ([Off] selected for [EVF Auto Switch], P. 553). Press and hold the control to display [EVF Auto Switch] options.
<b>IS Mode</b> (IS)	Toggle [AF/IS Settings] (P. 376) > [Image Stabilizer] in the  video menu on or off. Press once to select [Off] and again to turn image stabilization on. Hold the control and rotate the front or rear dial to access [Image Stabilizer] options.



Role	Function
<b>Preset MF (PreMF)</b>	Toggle [AF Mode] > [Preset MF] on or off (P. 357). Press the control once to enable preset MF and again to restore the previous focus mode. Alternatively, you can choose the [AF Mode] by holding the control and rotating a dial. You can press the button to toggle the focus mode during recording. Focus-mode selection using custom controls is not available when [mode2] is chosen for [Fn Lever Function].
<b>Lens Info Settings (Exif Lens)</b>	Recall previously-saved lens data. Recall saved data for the current lens after changing lenses or the like.
<b>S-AF</b>	Focus using [S-AF]. Press the control to focus. Focus will lock while the control is pressed.
<b>Flicker Scan (Flicker Scan)</b>	Press the control to select [On] for [Flicker Scan]. Adjust shutter speed until flicker is no longer visible. Press the control again to view or hide shooting information. Press and hold the control to exit. This option is available when [S] or [M] is selected for [Mode]. See page 374 for more on [Flicker Scan].
<b>Off</b>	The control is not used.

### ■ Access via the LV Super Control Panel

Select [Movie] mode before using the LV super control panel to access [Button Function]. In modes **P**, **A**, **S**, **M**, and **B** (still photography modes), the LV super control panel can be used to access [Button Function] (P. 463).

- 1 Highlight [Button Function] in the LV super control panel and press the **OK** button.
  - [Button Function] options will be displayed.

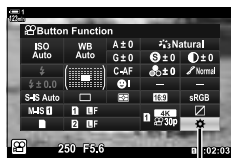

 button function

- 2 Highlight the desired control using  $\Delta$   $\nabla$  on the arrow pad and press the **▶** button.
- 3 Highlight a function using the  $\Delta$   $\nabla$  buttons and press the **OK** button to assign it to the selected control.
  - Repeat Steps 2 and 3 to assign functions to additional controls.
- 4 Press the shutter button halfway to exit the LV super control panel.

## ■ Menu Access

- 1 Press the **MENU** button to display the menus.
- 2 Highlight [ Button/Dial/Lever] in the video menu and press on the arrow pad.



- 3 Highlight [ Button Function] using the buttons and press the button.

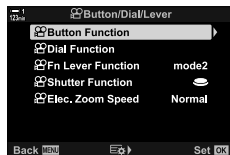

- 4 Highlight the desired control using the buttons and press the button.

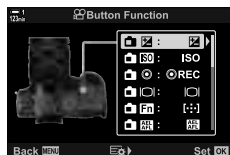

- 5 Highlight the desired option using the buttons and press the **OK** button.
  - Repeat Steps 4 and 5 as required.









- 6 Press the **MENU** button repeatedly to exit the menus.



3

# Choosing a Role for the Shutter Button





## ( Shutter Function)

Configure the shutter button as a  (movie record) button. A release cable can then be used to start or stop recording when the mode dial is rotated to  (movie).

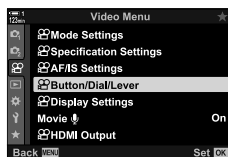

	The button functions as a shutter button. It can be used to initiate autofocus. It cannot be used to take pictures.
	Press the shutter button all the way down to start or stop movie recording. <ul style="list-style-type: none"><li>• The  button cannot be used for movie recording when [] is selected.</li></ul>

- 1 Press the **MENU** button to display the menus.
- 2 Highlight [ Button/Dial/Lever] in the  video menu and press  on the arrow pad.

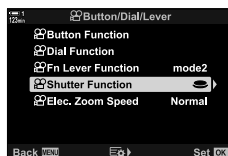

- 3 Highlight [ Shutter Function] using the   buttons and press the  button.



- 4 Highlight the desired option using the   buttons and press the **OK** button.







- 5 Press the **MENU** button repeatedly to exit the menus.

3



## Assigning Roles to the Front and Rear Dials (Dial Function)



Choose the roles played by the front and rear dials in  (movie) mode.

The roles played by the front and rear dials vary with the position of the **Fn** lever, and you can choose the functions assigned to them in each position. You can reverse the roles of the dials or reassign them for ease of use or as required by shooting conditions. Different assignments can be made for each [ Mode] (movie exposure mode).

The roles assigned to the dials using this item take effect in  (movie) mode. In addition, [mode1] must be selected for [ Fn Lever Function]. In **P**, **A**, **S**, **M**, and **B** (still photography) modes, the dials perform the roles selected in the  custom menu.

Different assignments can be made for each  (movie exposure) mode.

Role	Function	Exposure mode			
		P	A	S	M
<b>Shutter</b>	Choose the shutter speed.	—	—	✓	✓
<b>FNo.</b>	Adjust aperture.	—	✓	—	✓
	Adjust exposure compensation.	✓	✓	✓	✓
<b>ISO</b>	Adjust ISO sensitivity.	—	—	—	✓
<b>WB</b>	Adjust white balance.	✓	✓	✓	✓
<b>CWB Kelvin</b>	Choose a color temperature when CWB (custom) is selected for white balance.	✓	✓	✓	✓
 VOL	Adjust the recording level.	✓	✓	✓	✓
 VOL	Adjust headphone volume.	✓	✓	✓	✓
<b>Off</b>	None.	✓	✓	✓	✓

- 1 Press the **MENU** button to display the menus.
- 2 Highlight [ Button/Dial/Lever] in the  video menu and press  on the arrow pad.

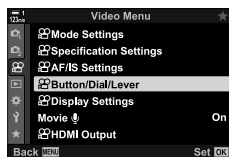

- 3 Highlight [Dial Function] using the  $\Delta$   $\nabla$  buttons and press the  $\triangleright$  button.

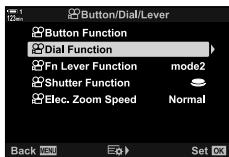

- 4 Highlight the desired mode and press the  $\triangleright$  button.
- Choose a dial using the  $\triangleleft$   $\triangleright$  buttons and use the  $\Delta$   $\nabla$  buttons to choose a role.
  - Press the **INFO** button to move between lever positions.
  - Press the **OK** button when settings are complete.

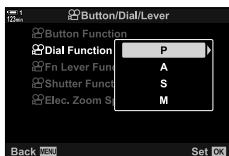

- 5 Press the **MENU** button repeatedly to exit the menus.

- When [VOL] or [VOL] is assigned to the front or rear dial, the recording level or headphone volume is shown in the display when the dials are rotated.

Recording level





3





## Customizing the Fn Lever (Fn Lever Function)

Choose the role played by the **Fn** lever in  (movie) mode.



The **Fn** lever can be used to choose the roles of the front and rear dials or to recall focus settings.

The role assigned to the **Fn** lever using this item takes effect in  (movie) mode. In **P**, **A**, **S**, **M**, and **B** (still photography) modes, the **Fn** lever performs the role selected in the  custom menu.

<b>Off</b>	Changing the position of the <b>Fn</b> lever has no effect.
<b>mode1</b>	Changing the position of the <b>Fn</b> lever reverses the roles of the dials (P. 424).
<b>mode2</b>	Focus settings change with the position of the <b>Fn</b> lever. Choose settings for [AF Mode], [AF Target Mode], and [AF Target Point].

- This option is not available when:
  - [mode3] is selected for  Fn Lever Function (P. 475) in  Custom Menu 
  - [Power 1] or [Power 2] is selected for [Fn Lever/Power Lever] (P. 501) in  Custom Menu 

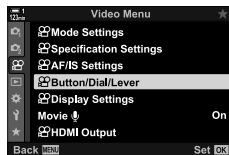

**1** Press the **MENU** button to display the menus.

**2** Highlight  [Button/Dial/Lever] in the  video menu and press  on the arrow pad.



**3** Highlight  [Fn Lever Function] using the   buttons and press the  button.



**4** Highlight the desired option using the   buttons and press the **OK** button.

- Pressing the  button when [mode2] is highlighted displays focus settings, allowing you to choose the settings recalled with the **Fn** lever.

[AF Mode]: S-AF, C-AF, etc.

[AF Target Mode]: Single, all, etc.

[AF Target Point]: AF-target position



**5** Press the **MENU** button repeatedly to exit the menus.

## ■ [Fn Lever Function] > [mode2]

When [mode2] is selected for [Fn Lever Function], the camera will store separate focus settings for Positions 1 and 2.

- The [MF] and [Preset MF] options assigned to controls using [Fn Button Function] cannot be used.

**1** Rotate the **Fn** lever to Position 1.

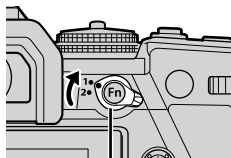

Fn lever

- The camera can store the settings selected for:  
[AF Mode]: S-AF, C-AF, etc.  
[AF Target Mode]: Single, all, etc.  
[AF Target Point]: AF-target position

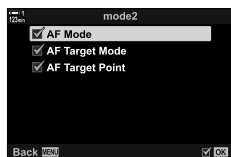

**2** Repeat the process for Position 2.

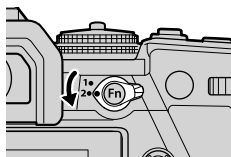

**3**

**3** Rotate the lever to the desired position to recall the saved settings.

## 3-13 Display Settings

Adjust display settings for movie recording.

You can choose whether to display on-screen controls in the form of the LV super control panel or live controls. You can also choose the indicators displayed in the monitor during filming. Choose options that suit your shooting style.

### Viewing On-Screen Controls (👤 Control Settings)

View or hide on-screen controls during shooting.

Use this option to hide on-screen controls (live controls and the LV super control panel) so that they cannot be displayed via the **INFO** button.

- 1 Press the **MENU** button to display the menus.
- 2 Highlight [👤 Display Settings] in the 👤 video menu and press **▶** on the arrow pad.

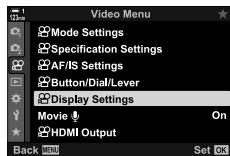

- 3 Highlight [👤 Control Settings] using the **△** **▽** buttons and press the **▶** button.

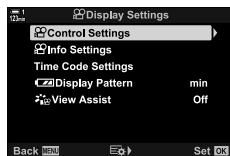

- 4 Select the desired controls.
  - Use the **△** **▽** buttons to highlight options and press the **OK** button to select or deselect. Items marked with a check can be displayed during shooting; those not marked with a check are hidden.



- 5 Press the **MENU** button repeatedly to exit the menus.
  - The **INFO** button cannot be used to toggle on-screen controls if it can be used to display options for the item currently selected in the live control display. Select a different item before using the **INFO** button to toggle the display.







Choose the indicators listed in the shooting display.

You can display or hide shooting setting indicators or view GPS or other sensor data (field sensor info). Use this option to choose the icons that appear in the display.

You can choose from two custom displays containing the indicators you select and a third display showing field sensor info.

- You can choose the items listed in the [Custom1] and [Custom2] displays. You cannot choose the contents of the [Field Sensor Info] display.

Indicator	Display	
	Custom1/Custom2	Field Sensor Info
	✓	—
Level Gauge	✓	—
Image Stabilizer	✓	✓
Picture Mode	✓	✓
WB	✓	✓
AF Mode	✓	✓
 Mode	✓	✓
	✓	✓
ISO	✓	✓
Time Code	✓	✓
Silent  Operation	✓	—
Grid	✓	✓
Altitude	—	✓
Heading	—	✓
Longitude and latitude	—	✓
Temperature	—	✓
Barometric pressure	—	✓

✓ : Can be displayed or hidden.

- 1 Press the **MENU** button to display the menus.
- 2 Highlight [**Display Settings**] in the video menu and press **▶** on the arrow pad.

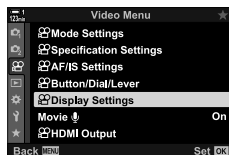

- 3 Highlight [**Info Settings**] using the **▲▼** buttons and press the **▶** button.

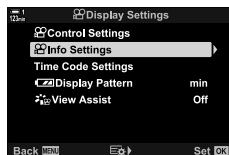

- 4 Highlight options using the **▲▼** buttons and press the **OK** button.
  - Selected items are marked with a **✓**. Selected items will be displayed. To deselect the current item, press the **OK** button again.
  - To choose the items displayed in the [Custom1] and [Custom2] displays, highlight the desired option and press the **▶** button. Highlight items using the **▲▼** buttons and press the **OK** button to select or deselect. Selected items will be displayed.

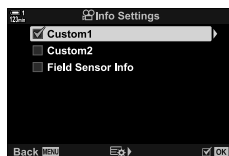

- 5 Press the **MENU** button repeatedly to exit the menus.

## ■ Choosing a Display

Press the **INFO** button during shooting to cycle through the selected displays.

**ℹ** “Choosing the Information Displayed” (P. 327)



# Battery Level Display Options

## ( Display Pattern)





Choose a format for the battery level display. Battery level can be displayed as a percentage or as the amount of shooting time remaining.

- The shooting time display is intended as a guide only.

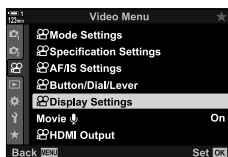

%	Battery level is shown as a percentage.
min	Battery level is shown as the shooting time remaining. In still photography modes, the battery level is displayed only while photos are being recorded.

- 1 Press the **MENU** button to display the menus.
- 2 Highlight [ Display Settings] in the  video menu and press  on the arrow pad.

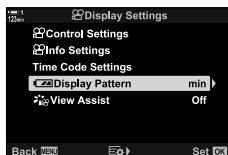

- 3 Highlight [ Display Pattern] using the   buttons and press the  button.



- 4 Highlight the desired option using the   buttons and press the **OK** button.

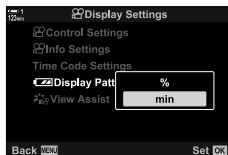

- 5 Press the **MENU** button repeatedly to exit the menus.

3

## 3-14 HDMI Devices



The camera can output video signals to HDMI devices. You can view the contents of the camera display in a monitor during shooting or use an HDMI recorder to record footage captured with the camera. This section describes settings for use when the camera is connected to an HDMI device.

Use the supplied cable protector and cable clip to prevent damage to the connectors when an HDMI cable is connected.  “Attaching Cable Protectors” (P. 29)

### HDMI Output

### HDMI Output

Adjust settings for output to HDMI devices. Options are available for controlling HDMI recorders from the camera or adding time codes for use during movie editing.

<b>Output Mode</b>	<p>[Monitor Mode]: The HDMI device functions as an external monitor. The camera outputs both images and indicators to the display. Output settings can be adjusted using the [HDMI] option in  Custom Menu <b>D4</b> (P. 434).</p> <p>[Record Mode]: The HDMI device functions as an external recorder. Only images are output to the device. Frame size and sound settings are adjusted using camera controls.</p> <ul style="list-style-type: none"><li>• The camera functions in [Monitor Mode] in modes <b>P</b>, <b>A</b>, <b>S</b>, <b>M</b>, and <b>B</b> (still photography modes), during playback, and when menus are displayed.</li></ul>
<b>REC Bit</b>	<p>The camera and the external device start and stop recording at the same time.</p> <ul style="list-style-type: none"><li>• This option is only available with compatible devices.</li></ul>
<b>Time Code</b>	<p>Output time codes to the external device. Time code settings can be adjusted using  Display Settings] &gt; [Time Code Settings] (P. 324).</p>

- 1 Press the **MENU** button to display the menus.
- 2 Highlight [HDMI Output] in the video menu and press **▶** on the arrow pad.



- 3 Highlight the desired item using the **▲▼** buttons and press the **▶** button.

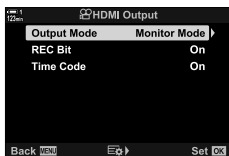

- 4 Highlight the desired option using the **▲▼** buttons and press the **OK** button.
  - Repeat Steps 3 and 4 as necessary.

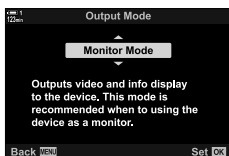

- 5 Press the **MENU** button repeatedly to exit the menus.

# External Monitor Display Options

# (HDMI)

Choose the signal output to external monitors connected via HDMI. Adjust the frame rate, movie frame size, and other settings according to monitor specifications.

<b>Output Size</b>	Choose the type of signal output to the HDMI connector. [C4K]: The signal is output in 4K digital cinema (4096 × 2160) format. [4K]: If possible, the signal is output in 4K (3840 × 2160). [1080p]: If possible, the signal is output in Full HD (1080p). [720p]: If possible, the signal is output in HD (720p). [480p/576p]: The signal is output in 480p/576p format.
<b>HDMI Control</b>	Selecting [On] allows the camera to be controlled using a remote that supports HDMI control.
<b>Output Frame Rate</b>	Choose the signal frame rate according to whether the device supports NTSC (60p) or PAL (50p).

1 Press the **MENU** button to display the menus.

2 Display **Custom Menu** **D4** (Disp/■)/PC).

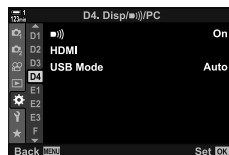

3 Highlight [HDMI] using  $\Delta$   $\nabla$  on the arrow pad and press the  $\blacktriangleright$  button.

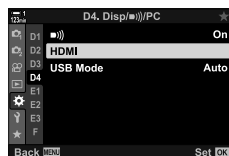

4 Highlight the desired item using the  $\Delta$   $\nabla$  buttons and press the  $\blacktriangleright$  button.

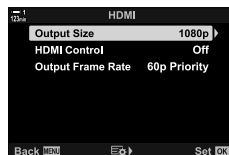

- 5** Highlight the desired option using the  $\Delta$   $\nabla$  buttons and press the **OK** button.
- Repeat Steps 4 and 5 as necessary.

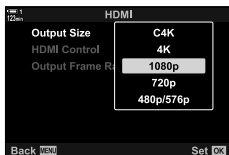

- 6** Press the **MENU** button repeatedly to exit the menus.

## 3-15 Working with Saved Movies

Movies are saved to the memory card and can be viewed in the camera monitor. Movies can be deleted or lightly edited using camera controls. You can also select movies for quick upload to a smartphone.

### Choosing the Information Displayed

Choose the information displayed during playback.

1 Press the  button.

- The most recent picture will be displayed.
- Movies are indicated by a representation of a piece of film stock in the background at the top and bottom of the display.



Single-frame playback

2 Press the **INFO** button.

- The information displayed changes each time the button is pressed.

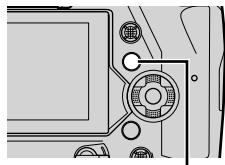

INFO button



Indicators displayed



Indicators hidden



## The Movie Playback Info Display







- |   |   |
|---|---|
| ① Battery level..... P. 44                          | ⑩ “Selected” icon..... P. 448           |
| ② Wireless LAN connection status ..... P. 584, 600  | ⑪  mode (movie exposure mode) .. P. 332 |
| ③ Active <b>Bluetooth</b> ® connection ..... P. 586 | ⑫  white balance ..... P. 380           |
| ④ Active connection to computer..... P. 600         | ⑬ Picture mode..... P. 388              |
| ⑤ Wireless LAN connection ..... P. 592, 596, 597    | ⑭ File number ..... P. 548              |
| ⑥ Movie indicator..... P. 436                       | ⑮ Frame number                          |
| ⑦ Movie audio ..... P. 413                          | ⑯ Current card slot ..... P. 302        |
| ⑧ “Share” icon ..... P. 446                         | ⑰  movie quality ..... P. 321           |
| ⑨ “Protected” icon ..... P. 439                     | ⑱ Date and time ..... P. 455            |
|   | ⑲ Time code ..... P. 324                |

# Finding Movies Quickly (Index and Calendar Playback)

"Index playback" lists the pictures on the memory card as small "thumbnail" images so that you can view multiple pictures at once. This makes it easier to find the movie you want. You can also switch to a calendar display and search for movies by date of recording.

- 1 Press the  button.
  - The most recent picture will be displayed.



- 2 Rotate the rear dial to .
  - Thumbnails will be displayed.
  - Highlight a picture with the multi selector. Press the multi selector to view the highlighted picture full frame.
  - You can also use the front dial or the arrow pad (   ).











Index playback

- 3 Without leaving the index display, rotate the rear dial to  again.



Calendar playback

- Calendar playback will start. The number of thumbnails in the index display can be chosen using [/Info Settings] (P. 515) > [ Settings] in  Custom Menu **D1**. If more than one type of display is selected, you may have to rotate the rear dial to  more than once to start calendar playback.
  - Highlight a date using the front dial or arrow pad and press the **OK** button. The first picture recorded on the selected date will be displayed.
  - Rotate the rear dial to  or  to cycle between full-frame, index, and calendar playback.
- You can choose a memory card for playback by:
    - Pressing the **CARD** button and then rotating the front or rear dial
    - Holding the  button and rotating the front or rear dial
- This does not change the option selected for [Card Slot Settings] (P. 547) > [ Slot] in  Custom Menu **D1**.
- Photographs recorded to the current card will also be displayed.

Protect pictures from accidental deletion. Protected pictures cannot be deleted using "delete all" but will be deleted if the memory card is formatted.

- This setting can be accessed via:
  - The button
  - The menus (P. 440)

## ■ Access via the (protect) Button

1 Press the button.

- The most recent picture will be displayed.



2 Rotate the front dial to display a picture you want to protect.

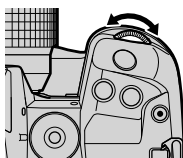

3 Press the button.

- A ("protected") icon will be displayed.
- Press the button again to remove protection.
- When an unprotected image is displayed, you can hold the button and rotate the front or rear dial to protect all images displayed while the dial is rotated. Any previously-protected images displayed while the dial is rotated will be unaffected.
- When a protected image is displayed, you can hold the button and rotate the front or rear dial to remove protection from all images displayed while the dial is rotated. Any previously-unprotected images displayed while the dial is rotated will be unaffected.
- The same operations can be performed during playback zoom or when a picture is selected in the index display.

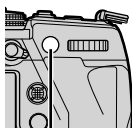

button

"Protected" icon



## ■ Menu Access

Display a movie and press the **OK** button to view options.

**OK** button → [On] → **OK** button → Press  $\Delta$  or  $\nabla$  on the arrow pad once to protect, again to remove protection → Press the **OK** button to save changes and exit

## Removing Protection from All Pictures (Reset Protect)

Remove protection from all pictures on the memory card in the current slot. Use this option if you have protected multiple pictures and want to remove protection from all images at once.

- 1 Press the **MENU** button to display the menus.
- 2 Highlight [Reset Protect] in the  playback menu and press  $\triangleright$  on the arrow pad.
- 3 Highlight [Yes] using the  $\Delta$   $\nabla$  buttons and press the **OK** button.
- 4 Press the **MENU** button repeatedly to exit the menus.

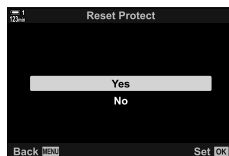

3

To copy a picture from one memory card to the other when two memory cards are inserted:

- 1 Press the  button.
  - The most recent picture will be displayed.



- 2 Rotate the front dial to display a picture you want to copy.

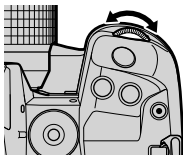

- 3 Press the **OK** button.
  - A menu of edit options will be displayed.



- 4 Highlight [Copy] using  $\Delta$   $\nabla$  on the arrow pad and press the **OK** button.
  - [Assign Folder to Copy to] options will be displayed.



- 5 To choose whether the picture is copied to a selected folder, highlight one of the following options and press the **OK** button.

[Assign]: Copy the picture to a new folder or to a selected existing folder. Proceed to Step 6.

[Do not assign]: Copy the picture to the current folder on the destination memory card.



**6** If you selected [Do not assign] in Step 5, choose the destination folder.

- Highlight [New Folder] or [Existing Folder] using the  $\Delta$   $\nabla$  buttons and press the **OK** button.

[New Folder]: Choose the desired folder number and press the **OK** button.

[Existing Folder]: Highlight an existing folder using the  $\Delta$   $\nabla$  buttons and press the **OK** button.



- If the chosen folder is unavailable, the camera will return to the previous display; repeat the process as required.

**7** Highlight [Yes] using the  $\Delta$   $\nabla$  buttons and press the **OK** button.





Copy all pictures from one memory card to the other when two memory cards are inserted.

[1]→[2]	Copy all pictures from the memory card in Slot 1 to the card in Slot 2.
[2]→[1]	Copy all pictures from the memory card in Slot 2 to the card in Slot 1.



- 1 Press the **MENU** button to display the menus.
- 2 Highlight [Copy All] in the  playback menu and press  on the arrow pad.

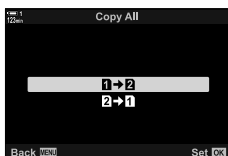

- 3 Highlight [1]→[2] or [2]→[1] using   buttons and press the **OK** button.



3

- 4 Highlight [Yes] using   buttons and press the **OK** button.

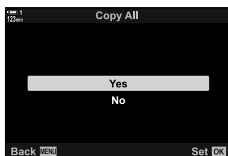

- 5 Press the **MENU** button repeatedly to exit the menus.

- Copying ends when the destination card is full.

Delete pictures from the memory card one at a time.

- Pictures can be deleted via:
  - The  button
  - The menus

## ■ Deleting Pictures via the Button

- 1 Press the  button.
  - The most recent picture will be displayed.



- 2 Rotate the front dial to display a picture you want to delete.

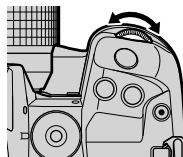

3

- 3 Press the  button.
  - A confirmation dialog will be displayed.

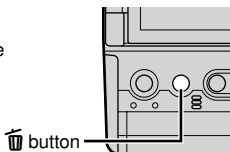



- 4 Highlight [Yes] using  $\Delta$   $\nabla$  on the arrow pad and press the **OK** button.

## ■ Deleting Pictures via the Menus

Display a picture and press the **OK** button to view options.

**OK** button  $\Rightarrow$  [Erase]  $\Rightarrow$  **OK** button  $\Rightarrow$  Highlight [Yes] using  $\Delta$   $\nabla$  on the arrow pad and press the **OK** button to select the highlighted option



- You can opt to skip the confirmation dialog when deleting images.   Custom Menu **H2** > [Quick Erase] (P. 551)



Delete all pictures from the memory card. Protected pictures will not be deleted.

- 1 Press the **MENU** button to display the menus.
- 2 Highlight [Card Setup] in the **Y** setup menu and press **▷** on the arrow pad.
  - If memory cards are inserted in both slots, you will be prompted to choose a slot. Select Slot 1 or Slot 2 and press the **OK** button.

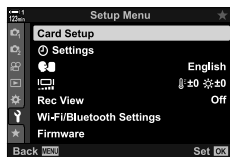

- 3 Highlight [All Erase] using the **△** **▽** buttons and press the **OK** button.
  - If there are no pictures on the card in the selected slot, the only option displayed will be [Format]. Choose a different slot.

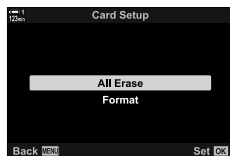

- 4 Highlight [Yes] using the **△** **▽** buttons and press the **OK** button.
  - The camera will begin the process of deleting all pictures on the card in the selected slot.
  - The camera will return to the shooting display when deletion is complete.

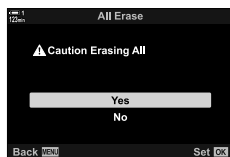

Smartphones running the OI.Share smartphone app can download movies from the camera. Pictures marked for download on the camera can be downloaded automatically when the camera is off.

For information on establishing a connection between the camera and smartphone, see “6-2 Connecting to Smartphones via Wi-Fi” (P. 584).

- This setting can be accessed via:
  - The  button
  - The menus (P. 447)

## ■ Access via the (Share) Button





- 1 Press the  button.
  - The most recent picture will be displayed.

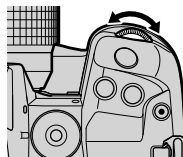

- 2 Rotate the front dial to display a picture you want to share.



3

- 3 Press the  button.
  - A  (“share”) icon will be displayed.
  - Press the  button again to remove share marking.
  - When an unmarked image is displayed, you can hold the  button and rotate the front or rear dial to mark for sharing all images displayed while the dial is rotated. Any previously-marked images displayed while the dial is rotated will be unaffected.

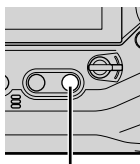

 button

“Share” icon



- When a marked image is displayed, you can hold the  button and rotate the front or rear dial to remove share marking from all images displayed while the dial is rotated. Any previously-unmarked images displayed while the dial is rotated will be unaffected.
- The same operations can be performed during playback zoom or when a picture is selected in the index display.

## ■ Menu Access

Display a picture and press the **OK** button to view options.

**OK** button ➔ [Share Order] ➔ **OK** button ➔ Press  $\Delta$  or  $\nabla$  on the arrow pad once to select, again to deselect ➔ Press the **OK** button to save changes and exit

- You can mark up to 200 pictures for sharing on each card.

## Removing Share Marking from All Pictures (Reset Share Order)

Remove share marking from all pictures on the card in the current slot.

- 1 Press the **MENU** button to display the menus.
- 2 Highlight [Reset share Order] in the  playback menu and press  $\triangleright$  on the arrow pad.
- 3 Highlight [Yes] using the  $\Delta$   $\nabla$  buttons and press the **OK** button.
- 4 Press the **MENU** button repeatedly to exit the menus.

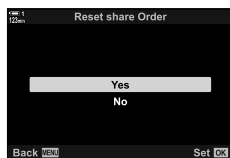

3

## Selecting Multiple Pictures

### (/Copy Select/Erase Selected/Share Order Selected)

You can select multiple pictures for protection, copying, deletion, or sharing.

1 Press the  button.





- The most recent picture will be displayed.

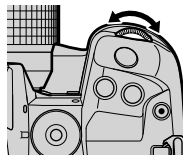

2 Rotate the front dial to display a picture you want to share.



3 Press the  button.

- A  ("selected") icon will be displayed.
- Press the  button again to deselect the picture.
- When an unmarked image is displayed, you can hold the  button and rotate the front or rear dial to select all images displayed while the dial is rotated. Any previously-marked images displayed while the dial is rotated will be unaffected.
- When a marked image is displayed, you can hold the  button and rotate the front or rear dial to deselect all images displayed while the dial is rotated. Any previously-unmarked images displayed while the dial is rotated will be unaffected.
- The same operations can be performed during playback zoom or when a picture is selected in the index display.

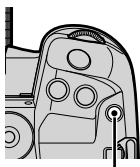

 button

"Selected" icon



- 4** After selecting pictures, press the **OK** button.
- To exit without proceeding to Step 5, press the **MENU** button.

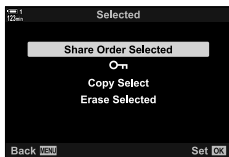

- 5** Highlight the operation you want to perform on the selected pictures ([**OK**], [Copy Select], [Erase Selected], or [Share Order Selected]) and press the **OK** button.



- The selected operation will be applied to all pictures marked with a ✓ icon.
  - If you selected [Copy Select] or [Erase Selected], additional options will be displayed; follow the menus to complete the operation.
- Exiting playback or turning the camera off deselects all selected pictures.

Simple edit options are available for existing movies. Trim unwanted footage or create a movie still from a selected frame.

## Trimming Movies

## (Movie Trimming)

Cut selected footage from movies. Movies can be trimmed repeatedly to create files containing only footage you want to preserve.

- 1 Press the  button, display the desired movie, and press the **OK** button.

- A menu of edit options will be displayed.



- 2 Highlight [Movie Edit] using  $\Delta$   $\nabla$  on the arrow pad and press the **OK** button.

- Movie edit options will be displayed.



3

- 3 Highlight [Movie Trimming] using the  $\Delta$   $\nabla$  buttons and press the **OK** button.

- You will be prompted to choose how you want to save the edited movie.

[New File]: Save the trimmed movie in a new file.

[Overwrite]: Overwrite the existing movie.

[No]: Exit without trimming the movie.



- 4 Highlight the desired option and press the **OK** button.

- You will be presented with an edit display.

- 5 Trim the movie.

- Use the  $\Delta$  button to skip to the first frame and the  $\nabla$  button to skip to the last frame.
- Using the front or rear dial, select the first frame of the footage you want to delete and press the **OK** button.
- Using the front or rear dial, highlight the last frame of the footage you want to delete and press the **OK** button.



- 6** Highlight [Yes] and press the **OK** button.
- The edited movie will be saved.
  - To select different footage, highlight [No] and press the **OK** button.
  - If you selected [Overwrite], you will be prompted to choose whether to trim additional footage from the movie. To trim additional footage, highlight [Continue] and press the **OK** button.



## Creating Movie Stills (In-Movie Image Capture)

Save a still copy of a selected frame.

- This option is available only with movies recorded at a frame size of [4K].

- 1** Press the  button, display the desired movie, and press the **OK** button.
- A menu of edit options will be displayed.



- 2** Highlight [Movie Edit] using  $\Delta$   $\nabla$  on the arrow pad and press the **OK** button.
- Movie edit options will be displayed.



- 3** Highlight [In-Movie Image Capture] using the  $\Delta$   $\nabla$  buttons and press the **OK** button.



- 4** Rotate the front or rear dial or use the  $\Delta$   $\nabla$   $\triangleleft$   $\triangleright$  buttons to display the desired frame and press the **OK** button.
- The camera will save a still copy of the selected frame.
  - Use the  $\Delta$  button to go back 2 seconds and the  $\nabla$  button to skip ahead 2 seconds.

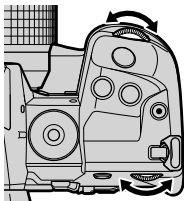

- 5** Press the **MENU** button repeatedly to exit the menus.





# 4 Customizing the Camera

---

Customize camera buttons and dials to suit your shooting style. You can also customize camera menus.

## 4-1 Basic Camera Settings (the $\gamma$ Setup Menu)

Adjust basic camera settings. Examples include language selection and monitor brightness. The setup menu also contains options used during the initial setup process.

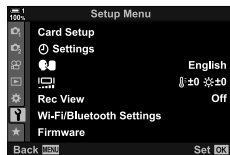

### 4

## Formatting Memory Cards and Deleting All Photos and Movies (Card Setup)

Ready memory cards for use in the camera. Format cards before recording photos or movies.

<b>Format</b>	Format the memory card. All data on the card will be deleted (P. 38).
<b>All Erase</b>	Delete all image data recorded with the camera. Protected files will not be deleted (P. 276, 445).

**MENU** button  $\Rightarrow$   $\gamma$  (setup menu) tab  $\Rightarrow$  [Card Setup]  $\Rightarrow$  Highlight a card slot using  $\Delta$   $\nabla$  on the arrow pad and press the  $\triangleright$  button  $\Rightarrow$  Highlight an option using the  $\Delta$   $\nabla$  buttons and press the **OK** button

## Setting the Camera Clock

(⌚ Settings)

Set the camera clock. You can also update the clock automatically via GPS. This option applies in both still photography and movie modes.

⌚	Set the clock (P. 45).
Time Zone	Choose a time zone. Although the time zone is selected after the clock is set, you can change it later using this option. You can also turn daylight saving time on or off.
Auto Time Adjust	The camera updates the clock using accurate time and date information provided by the GPS system. This option will only work if the time zone is set correctly. The clock does not update while the camera is off.  [Off]: The clock is not updated automatically. [On]: The clock is updated automatically to the time provided by GPS.

- The clock cannot be set if the camera's internal memory contains an unsaved sensor log.  
📷 "Field Sensor Logs" (P. 571)

**MENU** button ➔ ⏏ (setup menu) tab ➔ [⌚ Settings] ➔ Highlight an option using  $\Delta$   $\nabla$  on the arrow pad, and press the  $\triangleright$  button ➔ Adjust settings

## Choosing a Language

(🗨 Language)

4

Choose a language for camera menus and tool tips.

**MENU** button ➔ ⏏ (setup menu) tab ➔ Highlight [🗨] (language) and press  $\triangleright$  on the arrow pad ➔ Choose a language using the  $\Delta$   $\nabla$   $\triangleleft$   $\triangleright$  buttons

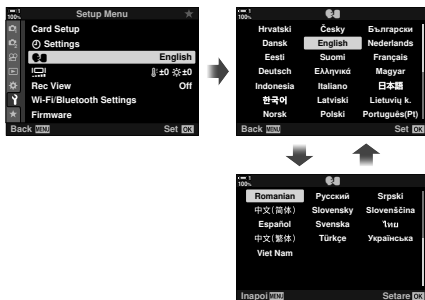

The next or previous page is displayed when you pass the first or last option on the current page.

## Monitor Brightness and Hue



Adjust monitor brightness, color temperature, and hue. This option applies in both still photography and movie modes.

<b>Color temperature</b> (☺)	Adjust color temperature. Choose from settings between +7 and -7.
<b>Brightness</b> (☺)	Adjust brightness. Choose from settings between +7 and -7.
<b>Hue</b>	Adjust hue. Choose from [Vivid] and [Natural].

- In mode **B**, monitor brightness is controlled by the option selected for [Bulb/Time Monitor].  
☺ Custom Menu **2** [Bulb/Time Monitor] (P. 534)

**MENU** button ➔ **Y** (setup menu) tab ➔ Highlight [!☺] and press **▷** on the arrow pad  
➔ Highlight [Color temperature (☺)] or [Brightness (☺)] using the **◀▶** buttons and use the **△▽** buttons to choose a value ➔ Press the **INFO** button and choose an option for [Hue]

4

## Post-Shooting Display Time

(Rec View)

Pictures are displayed immediately after shooting. This gives you a chance to quickly review the shot. You can choose how long pictures are displayed or disable photo review altogether. To end photo review and resume shooting at any time, press the shutter button halfway (P. 90).

- This item is for still photography.

<b>0.3–20 sec</b>	Choose how long photos are displayed.
<b>Off</b>	Photo review disabled. The camera continues to display the view through the lens after shooting.
<b>Auto</b> 	Switch to playback after shooting. You can delete images and use other playback functions.

**MENU** button ➔ **Y** (setup menu) tab ➔ Highlight [Rec View] and press **▷** on the arrow pad  
➔ select options

## Wireless LAN Options (Wi-Fi/Bluetooth Settings)

Adjust settings for connection to wireless networks. Take pictures and view pictures using a computer, or leave the camera off and view pictures on your smartphone while on the road. For information on establishing a connection and using these features, see “6-2 Connecting to Smartphones via Wi-Fi” (P. 584) or “6-3 Connecting to Computers via Wi-Fi” (P. 600).

<b>Availability</b>	Disable Wi-Fi and <b>Bluetooth</b> <sup>®</sup> . Disable Wi-Fi and <b>Bluetooth</b> <sup>®</sup> , for example in settings in which their use is prohibited, without changing network settings.
<b>Connection Password</b>	Change the Wi-Fi/ <b>Bluetooth</b> <sup>®</sup> password.
<b>Power-off Standby</b>	Choose whether the camera will connect to smartphones while off.
<b>Reset Settings</b>	Restore defaults for [Wi-Fi/Bluetooth Settings].
<b>Wi-Fi MAC Address</b>	Display the camera MAC address, which is sometimes needed when adjusting wireless network settings.

**MENU** button ➡ **Y** (setup menu) tab ➡ [Wi-Fi/Bluetooth Settings] ➡ Highlight an option using  $\Delta$   $\nabla$  on the arrow pad, and press the  $\triangleright$  button ➡ Adjust settings

## Viewing the Firmware Version (Firmware)

4

View the versions of the firmware for the camera and any lenses or other peripherals currently connected. You may need this information when contacting customer support or performing firmware updates.

**MENU** button ➡ **Y** (setup menu) tab ➡ Highlight [Firmware] and press  $\triangleright$  on the arrow pad

## 4-2 Custom Shooting Modes

Functions and custom settings can be saved to a selected position on the mode dial as a custom shooting mode. Multiple settings can be recalled simultaneously just by rotating the mode dial. The camera can store settings for four custom modes, one for each of positions **C1** through **C4** on the mode dial.

Settings recalled by selecting a custom mode can be adjusted as required. The stored settings recalled simply by rotating the mode dial.

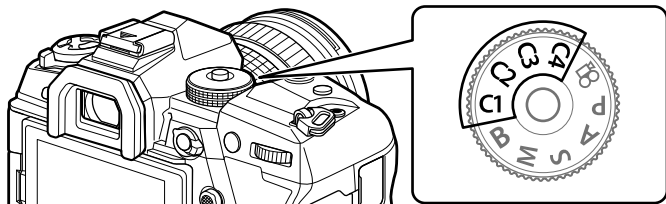

### 4



## Saving Settings to the Mode Dial (Assign to Custom Mode)

Current settings, including the shooting mode, can be saved to positions **C1** through **C4** on the mode dial. At default settings, these modes are equivalent to the default settings for mode **P** (program AE). For information on the settings that can be saved, see "7-4 Default Settings" (P. 640).

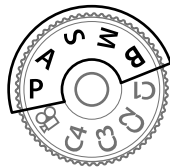
- 1 Rotate the mode dial to **P**, **A**, **S**, **M**, or **B** and adjust settings as desired.
  - See the menu list (P. 640) for information on the settings that can be stored.





- 2 Press the **MENU** button to display the menus.

**3** Highlight [Reset / Custom Modes] in  Shooting Menu 1 and press  on the arrow pad.



- [Reset / Custom Modes] options will be displayed.



**4** Highlight [Assign to Custom Mode] using the   buttons and press the  button.



- [Assign to Custom Mode] options will be displayed.

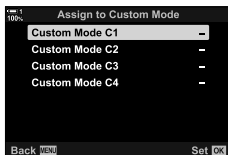

**5** Highlight **C1**, **C2**, **C3**, or **C4** using the   buttons and press the  button.

- The camera will display [Custom Mode] options for the selected mode.



**6** Highlight [Set] using the   buttons and press the **OK** button.

- Current settings will be saved to the selected mode and the camera will return to the [Assign to Custom Mode] display.
- Existing settings for the selected custom mode will be overwritten.
- To reset the selected custom mode to default settings, highlight [Reset] and press the **OK** button.



**7** Press the **MENU** button repeatedly to exit the menus.

Custom settings can be recalled using the mode dial, which restores all saved settings, or via the menus, which restores all settings except the shooting mode. You can choose the settings restored when a custom is selected. The saved settings will be restored when you next select the custom mode.

### ■ Access via the Mode Dial





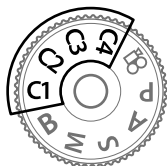



Rotate the mode dial to whichever custom mode (C1, C2, C3, or C4) was originally used to store the settings.

- The settings saved to the selected custom mode will be restored.



### ■ Menu Access

In modes other than  (movie), you can use the menus to recall settings saved to selected custom modes. The shooting mode remains that currently selected with the mode dial.

- 1 Choose the shooting mode in which you wish to use the saved settings.
- 2 Press the **MENU** button to display the menus.
- 3 Highlight [Reset / Custom Modes] in  Shooting Menu 1 and press  on the arrow pad.
  - [Reset / Custom Modes] options will be displayed.
- 4 Highlight [Recall from Custom Mode] using the   buttons and press the  button.
  - [Recall from Custom Mode] options will be displayed.
- 5 Highlight the desired custom mode using the   buttons and press the  button.

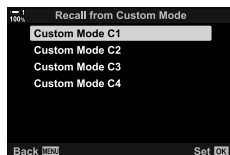



6 Highlight [Yes] using the  $\Delta$   $\nabla$  buttons and press the **OK** button.

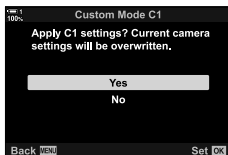

-  Shooting Menu 1 will be displayed.



7 Press the **MENU** button repeatedly to exit the menus.

### ■ Recalling Settings via the Fn Button

Custom settings can be recalled using a control to which [Recall from Custom Mode] has been assigned. This allows custom settings to be recalled at the touch of a button. You can also save and recall the shooting mode. Press the control once to recall saved settings, a second time to restore the settings previously in effect.

  Custom Menu **B1** >  Button Function] (P. 463)

## 4-3 Customizing Buttons and Dials

The camera is equipped with dials and variety of buttons used to adjust settings. Each of these controls has a default function. Each of these functions sees frequent use. Depending on your shooting style, you may nevertheless find yourself using other functions more frequently still. It is for just such situations that the camera has been provided with a variety of options for customizing controls.

Buttons that provide direct access to settings, such as the **ISO** and **WB** buttons, are referred to as “direct” buttons. You can choose the functions assigned to these buttons.

Depending on your subject or shooting style, you may find yourself frequently accessing settings in the menus. Such settings can also be assigned to direct buttons.

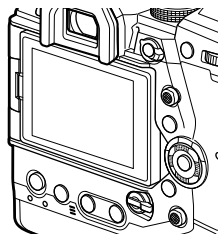

The front and rear dials, which are normally used to adjust exposure settings, can instead be used to adjust such settings as white balance and ISO sensitivity. The roles played by the dials can be selected using the **Fn** lever.

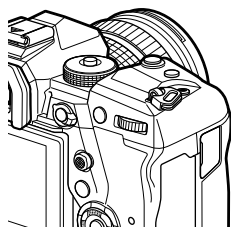

## Assigning Roles to Buttons (📷 Button Function)

Other roles can be assigned to buttons in place of their existing functions. Menu items can be assigned to buttons for quick access during shooting.

[📷 Button Function] is for still photography. The functions assigned to controls using this item are available only in modes **P**, **A**, **S**, **M**, and **B** (still photography modes). The functions assigned using [🎥 Button Function] in the 🎥 video menu take effect in 🎥 (movie) mode (P. 417).

- This setting can be accessed via:
  - The LV super control panel (P. 468)
  - The menus (P. 469)

























### ■ Customizable Controls



Icon	Button (orientation)	Default role
	(exposure compensation) button	Exposure compensation
	ISO button	ISO sensitivity
	(movie) button	Movie recording
	(LV) button	Display selection
	Fn button	AF-target mode
	AEL/AFL button	Exposure/focus lock
	WB button	White balance
	Arrow pad	AF-target selection
	Arrow pad ▷ (right)*	Off (🔌)
	Arrow pad ▽ (down)*	Off (📷/🎥)
	One-touch white balance button	One-touch white balance
	Preview button	Preview
	Vertical-use  (exposure compensation) button	Exposure compensation
	Vertical-use ISO button	ISO sensitivity
	Vertical-use AEL/AFL button	AEL/AFL
	Vertical-use one-touch white balance button	One-touch white balance
	Vertical-use preview button	Preview
	L-Fn (lens focus function buttons)	Lens Fn buttons (autofocus stop)

\* To use ▷ and ▽ on the arrow pad in their assigned roles, select [Direct Function] for (arrow pad).

## ■ Available Roles

Role	Function
<b>AF Stop</b>	Suspend autofocus. Focus locks and autofocus is suspended while the control is pressed. Applies only to lens <b>L-Fn</b> buttons.
<b>AEL/AFL</b> (AEL/AFL)	Lock focus and/or exposure (P. 141). When used for exposure lock, the control locks exposure when pressed and releases the lock when pressed a second time. The behavior of the control can be selected using [AEL/AFL] in <b>Custom Menu A1</b> .
<b>REC</b> (movie recording)	The control functions as a movie-record button. Press to start or stop recording.
<b>Direct Function</b> ([AEL/AFL]/[AEL/AFL])	Assign roles to the buttons on the arrow pad (△ ▽ ◀ ▶). The following roles can be assigned: ◀ button: [AEL/AFL] (AF-target selection) △ button: [AEL/AFL] (exposure compensation) ▶ button: [AEL/AFL] (flash) ▽ button: [AEL/AFL] (drive mode) • Use [AEL/AFL] and [AEL/AFL] to assign roles respectively to the ▶ and ▽ buttons.
<b>Preview</b> (Preview)	Stop aperture down to the selected value. This lets you preview depth of field. Aperture stops down to the currently-selected value while the button is pressed. Preview options can be selected using [Settings] in <b>Custom Menu D2</b> (P. 524).
<b>White Balance</b> (one-touch white balance)	Measure a value for one-touch white balance (P. 207). Frame a reference object (a piece of white paper or the like) in the display, then press and hold the control and press the shutter button. A list of one-touch white balance options will be displayed, from which you can choose the location to which the new value will be saved.
<b>AF Area Select</b> ([AEL/AFL])	Adjust AF-target settings. You can choose the AF-target mode (P. 120) and position (P. 123) and adjust settings for face/eye priority AF (P. 133). Press the control to view the AF-target selection display. Use the front or rear dial to choose AF-target mode and face/eye priority AF settings and the multi selector or arrow pad to position the AF target.
<b>[AEL/AFL] Home</b> (AF home position)	Recall previously-saved [AF Mode], [AF Target Mode], and [AF Target Point] “home position” settings. Press the control to recall saved settings and press it again to restore the settings previously in effect. Home position settings are saved using [AEL/AFL] Set Home in <b>Custom Menu A2</b> (P. 487). • You can save separate home positions for landscape and portrait orientations using [AEL/AFL] Orientation Linked [AEL/AFL] (P. 489) in <b>Custom Menu A2</b> .

Role	Function
<b>MF</b> (AF/MF toggle)	Switch between AF and MF. Press once to select MF and again to return to the previous mode. The focus mode can also be selected by holding the button and rotating a dial. This option has no effect when [mode2] is selected for [Fn Lever Function].
<b>RAW</b>  (RAW quality)	Switch between RAW + JPEG and JPEG [  ] settings. Press the control to switch from RAW or JPEG to RAW + JPEG or from RAW + JPEG to JPEG. You can also choose an image quality setting by holding the button and rotating a dial.
<b>Test Picture</b> (  TEST)	Take a test shot. You can view the effects of selected settings in an actual photograph. If you keep the control pressed while pressing the shutter button, you will be able to view the results but the picture will not be saved to the memory card.
<b>Custom Mode</b> <b>C1–C4</b>	Recall settings for the selected custom mode. Press the control once to recall saved settings, a second time to restore the settings previously in effect (P. 111, 460). The control continues to perform this function when a custom mode is selected with the mode dial.
<b>Exposure</b>  (  )	Adjust exposure settings. Hold the control and rotate the front or rear dial. Alternatively, you can press the button to activate settings and then rotate the dials. The adjustments available vary with the shooting mode:  [P]: Use the front or rear dial or  on the arrow pad for exposure compensation. Use the   buttons for program shift. [A]: Use the front or rear dial or  on the arrow pad for exposure compensation. Use the   buttons for aperture. [S]: Use the front or rear dial or  on the arrow pad for exposure compensation. Use the   buttons for shutter speed. [M]: Use the front dial or   on the arrow pad for shutter speed. Use the rear dial or the   buttons for aperture. [B]: Use   on the arrow pad to switch between bulb/time and live composite photography. Use the rear dial or   buttons to choose the aperture.
<b>Digital Teleconverter</b> (  )	Turn the digital teleconverter on or off (P. 235). Press once to zoom in and again to zoom out.
<b>Keystone Comp.</b> (  )	Press the control to view keystone compensation settings (P. 248). After adjusting settings, press the control again to exit. To cancel keystone compensation, press and hold the control.
<b>Fisheye Compensation</b> (  )	Enable fisheye correction (P. 250). Press once to enable fisheye correction. Press again to disable. Hold the button and rotate the front or rear dial to choose from [Angle] options 1, 2, and 3.

Role	Function
<b>Magnify</b> (Q)	Press the control once to display the zoom frame and again to zoom in (P. 136). Press the control a third time to exit zoom; to hide the zoom frame, press and hold the control. Use the multi selector, touch controls, or the arrow pad (△ ▽ ◀ ▶) to position the zoom frame.
<b>HDR</b> (HDR)	Enable HDR. Press once to enable HDR (P. 195). Press again to disable. Hold the button and rotate the front or rear dial to adjust HDR settings, including HDR bracketing.
<b>BKT</b> (BKT)	Enable bracketing. Press once to enable bracketing (P. 236). Press again to disable. Hold the button and rotate the front or rear dial to adjust [Call BKT Settings] settings.
<b>ISO</b>	Adjust [ISO] settings (P. 181). Hold the control and rotate the front or rear dial. Alternatively, you can press the button to activate settings and then rotate the dials. Use the front or rear dial or ◀▶ on the arrow pad to adjust settings.
<b>WB</b> (white balance)	Adjust [WB] settings (P. 202). Hold the control and rotate the front or rear dial. Alternatively, you can press the button to activate settings and then rotate the dials. Use the front or rear dial or ◀▶ on the arrow pad to adjust settings.
<b>Multi Fn</b> (multi Function)	Configure the control for use as a multi-function button (P. 470). Hold the control and rotate the front or rear dial to choose the function performed. The selected function can be performed by pressing the control.
<b>Peaking</b> (PEAK)	Toggle focus peaking on or off (P. 525). Press the control once to turn peaking on and again to turn it off. When peaking is on, peaking options (color, amount) can be displayed by pressing the <b>INFO</b> button.
<b>Level Disp</b> (  )	Display the digital level gauge. The exposure bar display in the viewfinder functions as a level gauge. Press the control again to exit. This option takes effect when [Style 1] or [Style 2] is selected for [EVF Style] (P. 554) in  Custom Menu  .
<b>View Selection</b> (display selection)	Switch between viewfinder photography and live view. If [Off] is selected for [EVF Auto Switch] (P. 553), the display will switch between the viewfinder and the monitor. Press and hold the control to display [EVF Auto Switch] options.
<b>S-OVF</b> (SOVF)	Enable [S-OVF] (P. 89). Press once to turn OVF simulation on. Press again to turn it off.

Role	Function
<b>AF Limiter (AF Limit)</b>	Enable the AF limiter (P. 143). Press once to enable [AF Limiter]. Press again to disable. Hold the button and rotate the front or rear dial to choose from three stored settings.
<b>Preset MF (PreMF)</b>	Toggle [ AF Mode] > [Preset MF] on or off (P. 129). Press the control once to enable preset MF and again to restore the previous focus mode. Alternatively, you can choose the [ AF Mode] by holding the control and rotating a dial. Focus-mode selection using custom controls is not available when [mode2] is chosen for [ Fn Lever Function] (P. 475).
<b>Lens Info Settings (Exif Lens)</b>	Recall previously-saved lens data (P. 550). Recall saved data for the current lens after changing lenses or the like.
<b>IS Mode (IS)</b>	Toggle [ Image Stabilizer] on or off (P. 176). Press once to select [Off] and again to turn image stabilization on. Hold the control and rotate the front or rear dial to access [ Image Stabilizer] options.
<b>Flicker Scan (Flicker Scan)</b>	Adjust settings for [ Flicker Scan] (P. 193). Press the control to select [On]. You can adjust shutter speed for best results while viewing banding in the display. Press the control again to display shooting information and access other settings. Press and hold the control to select [Off] for [ Flicker Scan].
<b>Lock</b> (touch control lock)	Lock touch controls. Press and hold the button once to lock touch controls and again to unlock. The  and  buttons must first be assigned a function using [Direct Function].
<b>Electronic Zoom (W↔T)</b>	Zoom power zoom lenses in or out. After pressing the control, use the arrow pad to zoom in or out. Use  or  on the arrow pad to zoom in and  or  to zoom out. The  and  buttons must first be assigned a function using [Direct Function].
<b>Flash Mode ()</b>	Adjust flash settings (P. 252). Press once to display flash options and again select the highlighted option and exit. Highlight settings using the front or rear dial or  on the arrow pad. The  and  buttons must first be assigned a function using [Direct Function].
(sequential shooting/self-timer)	Choose a drive (sequential shooting/self-timer) mode (P. 151). Press once to display drive mode options and again select the highlighted option and exit. Highlight settings using the front or rear dial or  on the arrow pad. The  and  buttons must first be assigned a function using [Direct Function].

Role	Function
<b>Live ND Shooting (ND)</b>	Enable the live ND filter (P. 197). Press once to enable [Live ND Shooting]. Press again to disable. Hold the button and rotate the front or rear dial to adjust [Live ND Shooting] settings.
<b>Off</b>	The control is not used.

## ■ Access via the LV Super Control Panel

Select mode **P**, **A**, **S**, **M**, or **B** before using the LV super control panel to access [📷 Button Function]. In 🎞 (movie) mode, the LV super control panel can be used to access [🎞 Button Function] (P. 417).

- 1 Highlight [📷 Button Function] in the LV super control panel and press the **OK** button.

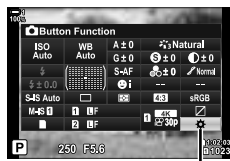

📷 button function

- 2 Highlight the desired control using  $\Delta$   $\nabla$  on the arrow pad and press the  $\triangleright$  button.

- 3 Highlight a function using the  $\Delta$   $\nabla$  buttons and press the **OK** button to assign it to the selected control.
  - Repeat Steps 2 and 3 to assign functions to additional controls.

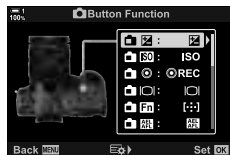

- 4 Press the shutter button halfway to exit the LV super control panel.



## ■ Menu Access

- 1 Press the **MENU** button to display the menus.
- 2 Display  Custom Menu **B1** (Button/Dial/Lever).



- 3 Highlight [ Button Function] using  $\Delta$   $\nabla$  on the arrow pad and press the  $\blacktriangleright$  button.



- 4 Highlight the desired control using the  $\Delta$   $\nabla$  buttons and press the  $\blacktriangleright$  button.



- 5 Highlight the desired option using the  $\Delta$   $\nabla$  buttons and press the **OK** button.
  - Repeat Steps 4 and 5 as required.



- 6 Press the **MENU** button repeatedly to exit the menus.

4

## Multi-Function Button Options (Multi Function)

Assign multiple roles to a single button.







Assigning [Multi Function] (multi-function) to a control turns it into a multi-function button.

The multi-function button can be used to:



<b>Highlight&amp;Shadow Control</b>	Individually adjust the brightness of highlights, shadows, and mid-tones (P. 227, 403).
<b>Color Creator</b>	Adjust saturation and hue. This also selects the [Color Creator] picture mode.
<b>ISO</b>	Display ISO sensitivity options (P. 181, 369).
<b>WB</b>	Display white balance options (P. 202, 380).
<b>Magnify</b>	Display the zoom frame. You can use super spot AF (P. 136, 364).
<b>Image Aspect</b>	Display aspect ratio options (P. 233).
<b>S-OVF</b>	Expand the dynamic range of the viewfinder display. Press again to restore the previous display (P. 89).
<b>Peaking</b>	Enable focus peaking. Press the control again to restore the previous display (P. 525).

- You can choose the options displayed.  "Choosing the Settings Available via Multi-Fn" (P. 472), [Multi Function Settings] (P. 521)

### ■ Assigning [Multi Function] to a Control

Before a control can be used as a multi-function button, it must be assigned the [Multi Function] role. The assignment for modes **P**, **A**, **S**, **M**, and **B** (still photography modes) is made using [ Button Function] (P. 463) in  Custom Menu  and that for  (movie) mode using [ Button Function] (P. 417) in the  video menu. Here's how the assignment can be made using the LV super control panel.

1 Highlight [ Button Function] in the LV super control panel and press the **OK** button.

- In modes **P**, **A**, **S**, **M**, and **B**, [ Button Function] options will be displayed, while in  mode [ Button Function] options will be displayed.

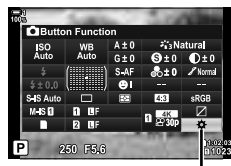

 button function

- 2 Highlight the desired control using  $\Delta$   $\nabla$  on the arrow pad and press the  $\triangleright$  button.

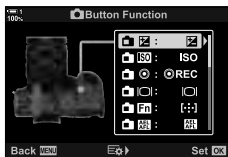

- 3 Highlight [Multi Function] using the  $\Delta$   $\nabla$  buttons and press the **OK** button.
- Depending on the control selected, [Multi Function] may not be available. Select a different control.

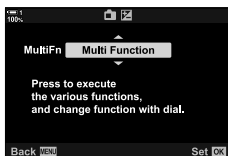

- 4 Press the **OK** button to exit when settings are complete.
- The camera will exit to the shooting display.

## ■ Using Multi-Function Buttons

- 1 Hold the button to which [Multi Function] is assigned and rotate the front or rear dial.
- Rotate the dial until the desired feature is highlighted. Release the button to select the highlighted feature.



- 2 Press the button to which [Multi Function] is assigned.
- 3 Adjust settings.

<b>Highlight&amp;Shadow Control</b>	Adjust brightness using the front or rear dial. Press the <b>INFO</b> button to choose the tone range (highlights, shadows, or mid-tones).
<b>Color Creator</b>	Use the front dial to adjust hue and the rear dial to adjust saturation.
<b>ISO</b>	
<b>WB</b>	Choose a setting using the front or rear dial.
<b>Magnify</b>	The zoom frame will be displayed.
<b>Image Aspect</b>	Choose a setting using the front or rear dial.
<b>S-OVF</b>	
<b>Peaking</b>	Press the button to turn the feature on or off.

## ■ Choosing the Settings Available via Multi-Fn

Choose the settings that can be accessed via multi-function buttons. The selection is made from a menu.

- 1 Press the **MENU** button to display the menus.
- 2 Display **⚙ Custom Menu D1 (Disp/■)/PC**, highlight [Multi Function Settings], and press **▶** on the arrow pad.

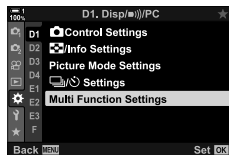

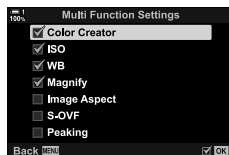

- 3 Choose the settings that can be accessed via multi-Fn.
  - Press the **OK** button to select items; selected items are marked with a **✓** and can be accessed via multi-Fn.
  - If you do not intend to use the item, press the **OK** button again to remove the **✓** and deselect the item.









- 4 Press the **MENU** button when settings are complete.
  - **⚙ Custom Menu D1** will be displayed.
- 5 Press the **MENU** button to exit the menus.
  - Highlight and shadow control is always available via multi-Fn.

## Assigning Roles to the Front and Rear Dials ( Dial Function)

Choose the roles performed by the front and rear dials. You can also choose the function selected using the **Fn** lever (P. 475). You can also choose the operations performed during playback or when menus are displayed.

The functions assigned to controls using this item are available only in modes **P**, **A**, **S**, **M**, and **B** (still photography modes). The functions assigned using [ Dial Function] in the  video menu take effect in  (movie) mode (P. 424).

The roles that can be performed by the dials in photo shooting and  playback modes are listed below. You can choose separate options for Positions 1 and 2 on the **Fn** lever.

Role	Function	Shooting mode				
		P	A	S	M	B
<b>Ps</b> (program shift)	Program shift.	✓	—	—	—	—
<b>Shutter</b>	Choose the shutter speed.	—	—	✓	✓	✓ *
<b>FNo.</b>	Adjust aperture.	—	✓	—	✓	✓
	Adjust exposure compensation.	✓	✓	✓	✓	✓
	Adjust flash compensation.	✓	✓	✓	✓	✓
<b>ISO</b>	Adjust ISO sensitivity.	✓	✓	✓	✓	✓
<b>WB</b>	Adjust white balance.	✓	✓	✓	✓	✓
<b>CWB Kelvin</b>	Choose a color temperature when CWB (custom) is selected for white balance.	✓	✓	✓	✓	✓
<b>Off</b>	None.	✓	✓	✓	✓	✓
 /Value (move cursor up or down)	Move the cursor up or down while menus are displayed.	—				
 (move cursor left or right)	Move the cursor left or right while menus are displayed.					
 (index/playback zoom)	Zoom in or out or switch to the index display during playback.	—				
<b>Prev/Next</b>	View the next or previous image during playback.					

\* Switch between bulb, time, and live composite.

1 Press the **MENU** button to display the menus.

2 Display **Custom Menu B1** (Button/Dial/Lever).



3 Highlight [Dial Function] using  $\Delta$   $\nabla$  on the arrow pad and press the  $\triangleright$  button.



4 Highlight the desired mode and press the  $\triangleright$  button.



**If you selected [P], [A], [S], or [M/B]:**

- Choose a dial using the  $\triangleleft$   $\triangleright$  buttons and use the  $\Delta$   $\nabla$  buttons to choose a role.
- Press the **INFO** button to move between lever positions.
- Press the **OK** button when settings are complete.

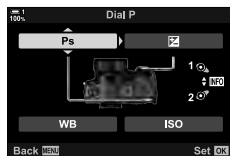

**If you selected [Menu] or [M/B]:**

- Choose a role using the  $\Delta$   $\nabla$  buttons and press the **OK** button.

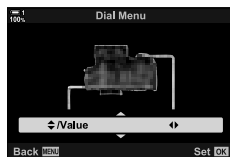

5 Press the **MENU** button repeatedly to exit the menus.

# Customizing the Fn Lever

## (📷 Fn Lever Function)

Choose the role played by the **Fn** lever.

The **Fn** lever can be used to choose the roles of the front and rear dials or to recall focus settings. It can also be used to select movie mode.

This setting takes effect in modes **P**, **A**, **S**, **M**, and **B** (still photography modes). The option selected using [📷 Fn Lever Function] in the [📷 video menu] take effect in [📷 (movie) mode] (P. 426).

<b>mode1</b>	Switch the functions of the front and rear dials. The functions for Positions 1 and 2 conform to the setting selected for [📷 Dial Function] (P. 473).
<b>mode2</b>	Switch between two groups of settings previously selected for [AF Mode], [AF Target Mode], and [AF Target Point].
<b>mode3</b>	Toggle the shooting mode. You can switch to [📷 (movie) mode] without rotating the mode dial.
<b>Off</b>	Changing the position of the <b>Fn</b> lever has no effect.

- This option is not available when [Power 1] or [Power 2] is selected for [Fn Lever/Power Lever] (P. 501) in ⚙ Custom Menu **B1**.

- 1 Press the **MENU** button to display the menus.
- 2 Display ⚙ Custom Menu **B1** (Button/Dial/Lever).



- 3 Highlight [📷 Fn Lever Function] using  $\Delta$   $\nabla$  on the arrow pad and press the  $\triangleright$  button.



- 4 Highlight the desired option using the  $\Delta$   $\nabla$  buttons and press the **OK** button.
  - Pressing the  $\triangleright$  button when [mode2] is highlighted displays focus settings, allowing you to choose the focus settings selected with the **Fn** lever.  
[AF Mode]: S-AF, C-AF, etc.  
[AF Target Mode]: Single, all, etc.  
[AF Target Point]: AF-target position



- 5 Press the **MENU** button repeatedly to exit the menus.

### ■ [📷 Fn Lever Function] > [mode2]

When [mode2] is selected for [📷 Fn Lever Function], the camera will store separate focus settings for Positions 1 and 2.

- The [MF] and [Preset MF] options assigned to controls using [📷 Button Function] cannot be used.

- 1 Rotate the **Fn** lever to Position 1.

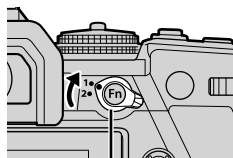

Fn lever

- The camera can store the settings selected for:  
[AF Mode]: S-AF, C-AF, etc.  
[AF Target Mode]: Single, all, etc.  
[AF Target Point]: AF-target position

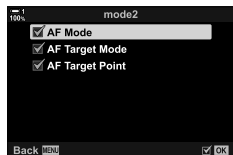

- 2 Repeat the process for Position 2.

4

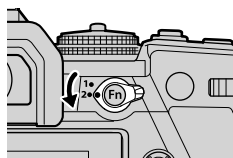

- 3 Rotate the lever to the desired position to recall the saved settings.



## 4-4 “My Menu”

The camera menus contain a profusion of items for different subjects and shooting styles. Quickly find the items you need when, for example, choosing menu options during shooting.



### Creating a Personalized Menu (My Menu)

4

You can use “My Menu” to create a personalized menu tab containing only items you select. “My Menu” can contain up to 5 pages of 7 items each. You can delete items or change the page or item order.

At purchase, “My Menu” contains no items.

- 1 Press the **MENU** button to display the menus.
- 2 Highlight an item for inclusion in “My Menu”.
  - Items that can be added to “My Menu” are indicated by a ★ icon at the top right corner of the display.

Item can be added to  
“My Menu”



**3** Press the **⊙** (movie) button.

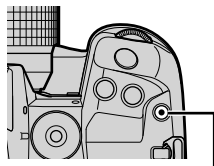

**⊙** (movie) button

- You will be prompted to choose a page. Use **Δ**/**▽** on the arrow pad to choose the "My Menu" page to which the item will be added.



**4** Press the **OK** button to add the item to the selected page.

- The camera will display a message stating that the item has been added to "My Menu".



- Items that have been added to "My Menu" are indicated by a yellow **★**.
- The next available page will be displayed once the seventh item is added to the current page.
- Items marked with a **★** can be removed from "My Menu" by pressing the **⊙** button. A confirmation dialog will be displayed; to proceed, highlight [Yes] and press the **OK** button.
- Items saved to "My Menu" are added to the **★** ("My Menu") tab.



4

**5** To access "My Menu", select the **★** ("My Menu") tab.

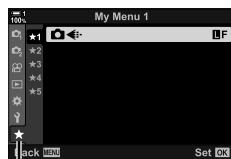

**★** ("My Menu") tab

## ■ Managing “My Menu”

You can reorder items in “My Menu”, move them between pages, or remove them from “My Menu” altogether.

- 1 Press the **MENU** button to display the menus.
- 2 Display the “My Menu” page you want to edit and press the  (movie) button.

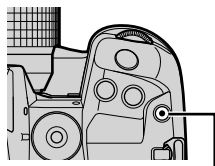

 (movie) button

- The options below will be displayed.
  - [Rearrange Order]: Change the order or items or pages. Use the arrow pad ( $\Delta \nabla \triangleleft \triangleright$ ) to choose the new location.
  - [Remove this item]: Remove the highlighted item from “My Menu”. Highlight [Yes] and press the **OK** button.
  - [Remove this ★ tab]: Remove from “My Menu” all items on the current page. Highlight [Yes] and press the **OK** button.



## 4-5 Customizing Camera Functions

The camera features many menus for customizing camera functions according to your subject or shooting style. Fine-tuning such functions as autofocus, drive mode, or exposure helps you get the most from your camera. These menus may be found under the  (custom) menu.

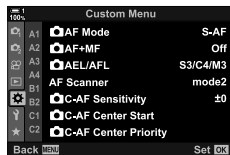

### Focus-Related Items

(Custom Menus **A1**, **A2**, **A3**, and **A4**)

These menus offer a variety of focus-related items.



#### **A1** Focus Mode

( AF Mode)

Choose the focus mode for auto or manual focus.

- This item is for still photography. See page 115 for more information.

<b>S-AF MF</b> */ <b>S-AF</b> (single AF)	Choose for photographs of subjects that are stationary or not moving away from or toward the camera. The camera focuses once each time the shutter button is pressed halfway.
<b>C-AF MF</b> */ <b>C-AF</b> (continuous AF)	Choose to track focus on subjects whose distance to the camera is continuously changing. The camera focuses continuously while the shutter button is pressed halfway.
<b>MF</b> (manual focus)	Focus manually by rotating the lens focus ring.
<b>C-AF+TR MF</b> */ <b>C-AF+TR</b> (tracking AF)	Choose to track focus on a specific subject while keeping the composition roughly the same. On detecting the subject, the camera will continue to track it while the shutter button is pressed halfway.
<b>Preset MF</b> (preset MF)	Focus at a preset distance.

- \* When [On] is selected for [ AF+MF], you can manually adjust focus using the lens focus ring after focusing via autofocus.  “**A1** Combined Auto and Manual Focus ( AF+MF)” (P. 481)

**A1** tab  $\Rightarrow$  [ AF Mode]  $\Rightarrow$  Choose an option

## **A1** Combined Auto and Manual Focus AF+MF

After focusing using autofocus, you can adjust focus manually by keeping the shutter button pressed halfway and rotating the focus ring.

Focus can be adjusted manually using the lens focus ring. Switch from auto to manual focus at will or fine-tune focus manually after focusing with autofocus. The procedure varies with the AF mode selected. [Off] is selected by default (P. 640).

- This item is for still photography. See page 115 for more information.

	Enable manual focus adjustment in autofocus mode. <b>MF</b> is displayed next to [S-AF], [C-AF], or [C-AF+TR].
<b>On</b>	<p><b>S-AF MF</b>: After focusing using single AF, you can keep the shutter button pressed halfway and adjust focus manually. Alternatively, you can switch to manual focus by rotating the focus ring while the camera is focusing. Focus can also be adjusted manually while the shutter is open and during burst photography in [Sequential Low] mode.</p> <p><b>C-AF MF/C-AF+TR MF</b>: You can switch to manual focus by rotating the focus ring while the camera is focusing in continuous AF and continuous tracking AF modes. Press the shutter button halfway a second time to refocus using autofocus. Focus can also be adjusted manually while the shutter is open and during burst photography in [Sequential Low] mode.</p>
<b>Off</b>	Manual focus adjustment disabled during autofocus.

- Autofocus with manual focus is also available when autofocus is assigned to other camera controls.  [AEL/AFL] (P. 141)
- The lens focus ring can be used to interrupt autofocus only when M.ZUIKO PRO (Micro Four Thirds PRO) lenses are used. For information on other lenses, visit the OLYMPUS website.
- In **B** (bulb) mode, manual focus is controlled by the option selected for [Bulb/Time Focusing].

**A1** tab  $\Rightarrow$   AF+MF  $\Rightarrow$  Use  $\Delta$   $\nabla$  to select [On] or [Off]

## A1 Setting Focus and Exposure with the AEL/AFL Button (AEL/AFL)

Choose how the camera sets focus and exposure when the shutter button or **AEL/AFL** button is pressed. The camera normally focuses and locks exposure when the shutter button is pressed halfway, but this can be changed according to the subject or shooting conditions.

- This item is for still photography. See page 141 for more information.

<b>mode1/mode2/ mode3/mode4</b>	Choose the combination of metering and/or focus performed when the <b>AEL/AFL</b> button is pressed or the shutter button is pressed halfway or all the way down.
<b>Half Way AF</b>	Choose whether the camera focuses if the shutter button is pressed halfway when autofocus is assigned to the <b>AEL/AFL</b> button in focus modes [S-AF], [S-AF <b>MF</b> ], [C-AF], and [C-AF <b>MF</b> ].  [Operative]: The camera focuses when the shutter button is pressed halfway.  [Inoperative]: The camera does not focus when the shutter button is pressed halfway.

A1 tab ➔ [AEL/AFL] ➔ Choose an option

## A1 C-AF Lens Scanning (AF Scanner)

Choose whether the camera performs a focus scan. If the camera is unable to focus, it will scan for the focus position by cycling the lens from the minimum focus distance to infinity. You can limit the scanning operation if desired.

- This item is for still photography. See page 146 for more information.
- The selected option takes effect when [C-AF], [C-AF+TR], [C-AF **MF**], or [C-AF+TR **MF**] is chosen for [AF Mode] (P. 115).

<b>mode1</b>	The camera will not scan if unable to focus. This prevents focus changing to such an extent that you lose sight of your subject when attempting to track small objects and the like.
<b>mode2</b>	When unable to focus, the camera scans only once at the start of the focus operation. The camera will not scan again as long as the focus operation continues.
<b>mode3</b>	The camera scans when unable to focus, cycling focus as often as necessary if it loses track of the subject during the focus operation.

A1 tab ➔ [AF Scanner] ➔ Choose an option

## **A1** C-AF Tracking Sensitivity C-AF Sensitivity

Choose how rapidly the camera responds to changes in the distance to the subject during focusing. This can help prevent the camera refocusing when you are unable to track a quickly-moving subject or when an object passes between the subject and the camera.

- This item is for still photography. See page 145 for more information.
- The selected option takes effect when [C-AF], [C-AF+TR], [C-AF MF], or [C-AF+TR MF] is chosen for  AF Mode] (P. 115).
- The higher the value, the higher the sensitivity. Choose positive values for subjects that suddenly enter the frame, that are moving rapidly away from the camera, or that change speed or stop suddenly while moving toward or away from the camera.
- The lower the value, the lower the sensitivity. Choose negative values to prevent the camera refocusing when the subject is briefly obscured by other objects or to prevent the camera focusing on the background when you are unable to keep the subject in the AF target.



**A1** tab ➔  C-AF Sensitivity] ➔ Choose an option

## **A1** C-AF Starting Focus Target C-AF Center Start

When used in combination with an AF-target mode other than single target, [C-AF], [C-AF MF], [C-AF+TR], and [C-AF+TR MF] focus on the center of the selected group only during the initial scan. During later scans, the camera will focus using the surrounding targets. Combining this option with an AF-target mode that covers a wide area makes it easier to focus on erratically-moving subjects.

- This item is for still photography. See page 147 for more information.

**A1** tab ➔  C-AF Center Start] ➔ Highlight options and press the **OK** button

- Center start is enabled in modes indicated by a .
- Center start does not take effect when  C-AF Center Priority] (P. 148) is enabled.

## **A1** C-AF Center Target Priority (📷 C-AF Center Priority)

When focusing using group- or custom-target AF in [C-AF] and [C-AF MF] modes, the camera always assigns priority to the center target in the selected group for a repeated series of focus operations. Only if the camera is unable to focus using the center focus target will it focus using the surrounding targets in the selected focus group. This helps you track subjects that are moving quickly but relatively predictably. C-AF center priority is recommended in most situations.

- This item is for still photography. See page 148 for more information.

**A1** tab ➔ [📷 C-AF Center Priority] ➔ Highlight options and press the **OK** button

- Center priority is enabled in modes indicated by a ✓.



## **A2** Hiding AF Target Modes ( [Mode Settings] )

Choose the target modes displayed during AF-target mode selection (P. 120).  
Hiding unused modes speeds target-mode selection.

- This item is for still photography.

**1** Highlight [ [Mode Settings] in the **A2** (AF/MF) menu and press **▶** on the arrow pad.

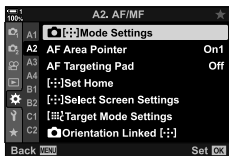

**2** Highlight an AF target mode you wish to have displayed.



**3** Press the **OK** button.

- Selected items are marked with a ✓.

**4** Press the **MENU** button repeatedly to exit when settings are complete.

- Only items marked with ✓ will be available during AF-target mode selection.



- The custom AF-target mode is hidden by default. Select the custom mode to enable custom AF-target selection. [Target Mode Settings] (P. 125)

## A2 AF Target Display Mode (AF Area Pointer)

In autofocus mode, the position of the subject on which the camera has focused is shown by a green focus target. This item controls the display of the focus target.

Off	The focus target is not displayed.
On1	The focus target is displayed only briefly after the camera focuses.
On2	After the camera focuses, the focus target will be displayed while the shutter button is pressed halfway.

A2 tab ➔ [AF Area Pointer] ➔ Choose an option

- [On2] is not available in movie mode.
- To enable cluster AF targeting when **ALL** (all targets) is selected and [S-AF], [S-AF MF], [C-AF], or [C-AF MF] is chosen for [AF Mode] (P. 115), select [On2] for [AF Area Pointer] (P. 486). The camera will display AF targets for all areas that are in focus.



4

## A2 Touch AF Target Selection for Viewfinder Photography (AF Targeting Pad)

Use touch controls in the monitor to select the AF target during viewfinder photography. Glide a finger over the monitor to position the focus target while viewing your subject in the viewfinder.

- This item applies during both still photography and movie recording.

Off	Monitor touch controls cannot be used for AF-target selection during viewfinder photography.
On	Monitor touch controls can be used for AF-target selection during viewfinder photography. Gently tap the monitor twice to enable or disable touch AF-target selection. When the target reaches the edge of the display, you can lift and then glide your finger again to enable <b>ALL</b> (all target) mode.

- When [On] is selected, touch controls can also be used to position the zoom frame (P. 136).

A2 tab ➔ [AF Targeting Pad] ➔ Choose an option

## A2 Choosing the AF Home Position ([::]) Set Home)

Choose the home position for the [::] Home] feature.

The [::] Home] feature lets you recall a previously-saved “home position” for autofocus at the touch of a button. This item is used to choose the home position.

To access [::] Set Home], assign it to a control using [📷 Button Function] (P. 463). You also have the option of assigning it to the multi selector using [🔘 Center Button] (P. 499). If [📷 Orientation Linked [::]] (P. 489) is active, the camera will store separate home positions for landscape (wide) and portrait (tall) orientations.

- This item is for still photography.

<b>AF Mode</b>	Choose the home position autofocus mode.
<b>AF Target Mode</b>	Choose the home position AF target mode. Only options selected for [📷]Mode Settings] are available.
<b>AF Target Point</b>	Choose the home position focus target.

- 1 Highlight [::]Set Home] in the A2 (AF/MF) menu and press  $\triangleright$  on the arrow pad.



- 2 Highlight a setting you wish to store with the home position and press the **OK** button.
  - Selected items are marked with a ✓. Items marked with a ✓ are included in the home position.



- 3 Press  $\triangleright$  on the arrow pad to display options for the highlighted setting.
  - Choose settings for the home position.
  - When [📷 Orientation Linked [::]] is active, you will be prompted to select landscape or portrait (camera rotated left/camera rotated right) orientation before pressing the  $\triangleright$  button to display options.
- 4 Press the **OK** button to save changes when settings are complete.
  - The settings list will be displayed.
- 5 Press the **MENU** button repeatedly to exit when settings are complete.

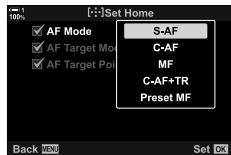

4

## A2 AF-Target Selection ([::] Select Screen Settings)

Choose the roles played by the front and rear dials or arrow pad during AF target selection. The controls used can be selected according to how the camera is used or personal taste. You can choose up to two combinations.

- This item applies during both still photography and movie recording.

### Available Controls

Front dial, rear dial,  $\Delta$   $\nabla$  on the arrow pad, the  $\triangleleft$   $\triangleright$  buttons.

### Available Roles

[ $\cdot$  Pos]: Position the AF target

[[::]]Mode]: Choose the AF target mode (e.g., all, small, or group).

[ $\odot$ ]: Adjust settings for face/eye detection AF.

A2 tab  $\Rightarrow$  [[::]] Select Screen Settings]  $\Rightarrow$  Choose a set\*  $\Rightarrow$  Choose a control (front or rear dials or arrow pad)  $\Rightarrow$  Choose a role

- \* If you select [Set 2], the options in the [[::]] Select Screen Settings] menu will be checked ( $\checkmark$ ). [Set 2] can be recalled by pressing the **INFO** button in the AF-target selection display.

## A2 AF Target Size and Positioning ([::] Target Mode Settings)

Choose the number of AF targets available and how far the AF target moves during AF-target selection. Targets can be larger than group targets or sized for subjects whose motion can be predicted. You can also increase the distance between available targets for faster target selection. The camera can store up to four different combinations of settings.

- This item is for still photography. See page 125 for more information.

Size	Choose the target size. Target width and height can be set separately. Choose from options of 1, 3, 5, 7, 9, and 11.
Step	Choose the number of steps the target moves during target selection. The horizontal and vertical step sizes can be set separately; choose from steps of 1, 2, and 3.

A2 tab  $\Rightarrow$  [[::]] Target Mode Settings]  $\Rightarrow$  Choose an option

- If the AF-target or step size is altered from the default value, a  $\checkmark$  will appear next to the custom target option in [[::]]Mode Settings] (P. 485).

## A2 Matching AF-Target Selection to Camera Orientation (Orientation Linked [:::])

The camera can be configured to change the AF-target position and AF-target mode automatically when it detects that it has been rotated between landscape (wide) or portrait (tall) orientations. Rotating the camera changes the composition and consequently also the position of the subject in the frame. The camera can store the AF target mode and AF target position separately according to camera orientation. When this option is active, [:::] Set Home] (P. 487) can be used to store separate home positions for landscape and portrait orientations.

- This item is for still photography.

<b>AF Target Mode</b>	Choose separate AF target modes (e.g., all, small, or group) for landscape and portrait orientations.
<b>AF Target Point</b>	Choose separate AF targets for landscape and portrait orientations.

- 1 Highlight [Orientation Linked [:::]] in the A2 (AF/MF) menu and press  $\blacktriangleright$  on the arrow pad.

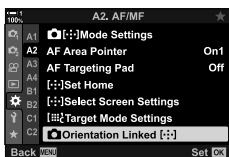

- 2 Highlight a setting you wish saved separately and press the OK button.
  - Selected items are marked with a ✓.

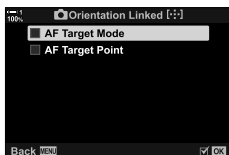

- 3 Press the MENU button repeatedly to exit when settings are complete.
  - Press the MENU button repeatedly to exit the menus.
- 4 Choose the AF target mode or target position with the camera first in one orientation and then the other.
  - Separate settings are stored for landscape orientation, portrait orientation with the camera rotated to the right, and portrait orientation with the camera rotated to the left.

## A3 Lens Focus Range (AF Limiter)

Choose the range in which the camera will focus using autofocus. This is effective in situations in which an obstacle presents itself between the subject and the camera during the focus operation, causing drastic changes in focus. You can also use it to prevent the camera focusing on foreground objects when shooting through a fence, window, or the like.

- This item is for still photography. See page 143 for more information.

<b>Distance settings</b>	Choose the range of focus distances available. The camera can store up to three settings for different situations. Distances are approximate and intended as guides only.
<b>Release Priority</b>	The shutter can still be released if the camera is unable to focus when [On] is selected for [AF Limiter].

A3 tab ➔ [AF Limiter] ➔ Choose an option



[AF Limiter] can be assigned to a button. You then need only press the button to limit focus range. Hold the button and rotate a dial to choose from the three stored settings.

[Button Function] (P. 463)

4

## A3 AF Illuminator Autofocus Assist (AF Illuminator)

The AF illuminator lights to assist the focus operation when lighting is poor.

<b>On</b>	The illuminator lights during autofocus if the subject is poorly lit.
<b>Off</b>	The illuminator does not light even if the subject is poorly lit.





A3 tab ➔ [AF Illuminator] ➔ Choose an option

- To use the AF illuminator during silent photography, you will need to change the option selected for [Silent Mode Settings] (P. 167).

## A3 Face/Eye Priority AF (☺ Face Priority)

The camera detects faces automatically. Depending on the option selected, it can detect and focus on faces or eyes. In either instance, exposure is weighted according to the value metered for the face.

- This item applies during both still photography and movie recording. See pages 133 and 360 for more information.

 (face priority on)	The camera detects and focuses on faces.
<b>OFF</b> (face priority off)	Face priority AF off.
 (face and eye priority)	The camera detects faces and focuses on the eye closest to the camera.
 (face and right eye priority)	The camera detects faces and focuses on the right eye.
 (face and left eye priority)	The camera detects faces and focuses on the left eye.

A3 tab ➔ [☺ Face Priority] ➔ Choose an option

## A3 Tracking Focus on Selected Subjects (📷 Tracking Subject)

The camera can detect and track subjects of specific types when focusing using [C-AF+TR] or [C-AF+TR **ME**]. You may find it hard to focus on the driver or cockpit of a fast-moving subject such as a race car or airplane. This feature detects and focuses specific elements of such subjects.

- This item is for still photography. See page 149 for more information.

<b>Motorsports</b>	The camera detects cars or motorcycles. It tracks focus on such elements as the chassis (chiefly of types used in motor sports) or driver.
<b>Airplanes</b>	The camera detects planes and helicopters. It tracks focus on such elements as the fuselage or cockpit.
<b>Trains</b>	The camera detects trains. It tracks focus on such elements as the cars or driver's compartment.
<b>Off</b>	Tracking subject selection disabled.

A3 tab ➔ [📷 Tracking Subject] ➔ Choose an option

- Selecting an option other than [Off] automatically sets face/eye detection to [Off].
- The following cannot be used while photography is in progress:
  - the live ND filter, interval-timer or HDR photography, keystone compensation, fisheye correction, High Res Shot, focus bracketing, or Pro Capture High

## A3 Fine-Tuning Autofocus (AF Focus Adj.)

Fine-tune phase-detection autofocus. Focus can be fine-tuned by up to  $\pm 20$  steps.

- This item is for still photography.
- Normally there is no need to fine-tune autofocus using this item. Fine-tuning focus may prevent the camera focusing normally.
- Focus fine-tuning has no effect in [S-AF] and [S-AF MF] modes.

<b>Off</b>	Fine-tuning disabled.
<b>Default Data</b>	Fine-tune focus for all lenses.
<b>Lens Data</b>	Save fine-tuning values on a lens-by-lens basis. The camera can store fine-tuning values for up to 20 lenses. Focus for individual lenses can be fine-tuned in specific areas of the frame. In the case of zoom lenses, separate values can be stored for long and short focal lengths.

- 1 Highlight [AF Focus Adj.] in the **A3** (AF/MF) menu and press  $\triangleright$  on the arrow pad.

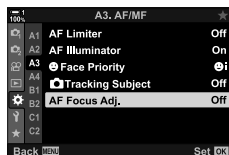

- 2 Highlight [Default Data] or [Lens Data] and press the  $\triangleright$  button.

- If you selected [Default Data], proceed to Step 5.
- To disable fine-tuning, highlight [Off] and press the **OK** button.

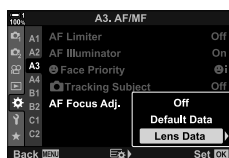

- 3 Highlight [Create Lens Data Set] and press the **OK** button.

- You will be prompted to choose the area of the frame for which focus will be fine-tuned.

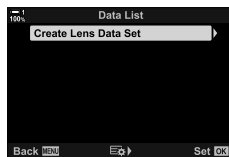

- 4 Use the  $\triangle$   $\nabla$   $\triangleleft$   $\triangleright$  buttons to choose an area of the frame and then press the **OK** button.

- With zoom lenses, you can press the **INFO** button to choose between long (telephoto) and short (wide) focal lengths.

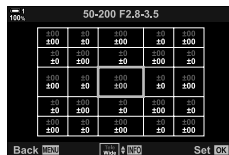



- 5** Choose a fine-tuning value using the  $\Delta$   $\nabla$  buttons and press the **OK** button.
- The selected value will be saved. If you chose [Default Data], the options shown in Step 2 will be displayed.
  - If you chose [Lens Data], the dialog shown in Step 3 will be displayed. The display will show the name of the lens for which the fine-tuning value was saved.
  - Rotate the rear dial to zoom in and check focus.
  - Before pressing the **OK** button, press the shutter button to take a test shot and check focus.
  - To save another fine-tuning value for the current lens, press the  $\triangleright$  button and repeat the process from Step 4.
- 6** To fine-tune focus for the same lens but in a different area of the frame, highlight the lens name using the  $\Delta$   $\nabla$  buttons and press the  $\triangleright$  button.
- Repeat the process from Step 4.

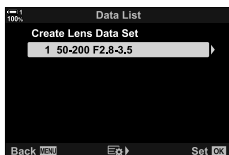

- 7** When the process is complete, press the **MENU** button repeatedly to exit the menus.

## ■ Deleting Saved Values

- 1** Highlight [AF Focus Adj.] in the **A3** (AF/MF) menu and press  $\triangleright$  on the arrow pad.



4

- 2** Highlight [Lens Data] using the  $\Delta$   $\nabla$  buttons and press the  $\triangleright$  button.



- 3** Use the  $\Delta$   $\nabla$  buttons to highlight the name of the lens you wish to delete from the fine-tuning list and then press the  $\triangleright$  button.

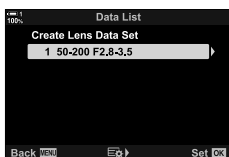

- 4 Highlight [Delete] using the  $\Delta$   $\nabla$  buttons and press the  $\triangleright$  button.

- A confirmation dialog will be displayed.



- 5 Highlight [Yes] using the  $\Delta$   $\nabla$  buttons and press the **OK** button.

- The dialog shown in Step 3 will be displayed. Confirm that the lens name has been deleted.



- To disable AF fine-tuning without deleting the entries for the current lens, select [Off] for [AF Focus Adj.].



- The camera can store multiple values for each lens.

## ■ Enabling Fine-Tuning

Display the lens data list and place checks (✓) next to the items you wish to use.

**A3** tab  $\Rightarrow$  [AF Focus Adj.]  $\Rightarrow$  [Lens Data]  $\Rightarrow$  Highlight items using the  $\Delta$   $\nabla$  buttons and press the **OK** button

4

## **A4** Choosing a Focus Distance for Preset MF (Preset MF distance)

Quickly focus at a previously-stored distance. An example of a situation in which this option might be effective is astronomical photography featuring the moon or stars, when you want to focus quickly at infinity.

- This item applies during both still photography and movie recording. See pages 129 and 357 for more information.

**A4** tab  $\Rightarrow$  [Preset MF distance]  $\Rightarrow$  Choose a value

- If the lens is equipped with a focus limiter, disable it before proceeding.
- The figures displayed are intended as guides only.

## A4 Manual Focus Assist (MF Assist)

This feature is used to assist manual focus. You can set the camera to automatically zoom in on the view through the lens or highlight in-focus areas in color when the lens focus ring is rotated.

- This item applies during both still photography and movie recording.

<b>Magnify</b>	The display automatically zooms in on the view through the lens when the lens focus ring is rotated.
<b>Peaking</b>	In-focus areas are highlighted in color when the lens focus ring is rotated.

- The highlight color and other peaking settings can be adjusted using the [Peaking Settings] item in Custom Menu **D3** (P. 525).
- Focus zoom is not available during movie recording or when [C-AF **MF**] or [C-AF+TR **MF**] is selected for focus mode.

- 1 Highlight [MF Assist] in the **A4** (AF/MF) menu and press on the arrow pad.

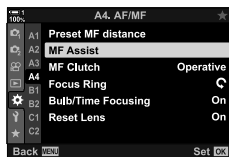

- 2 Highlight [Magnify] or [Peaking] and press the button.

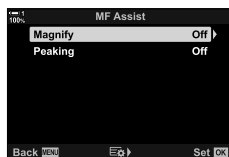

- 3 Choose an option using the buttons and press the **OK** button.

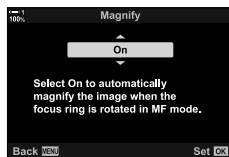



- 4 When settings are complete, press the **MENU** button repeatedly to exit the menus.

- When manual focus is in effect, you can:
  - Rotate the front or rear dial to zoom in or out during focus zoom.
  - Display focus peaking options by pressing the **INFO** button during focus peaking. Highlight options using the front dial or buttons and use the rear dial or buttons to choose settings. You can adjust [Peaking Color], [Highlight Intensity], and [Image Brightness Adj.].

## **A4** Disabling the MF Clutch **(MF Clutch)**

Disable the manual focus clutch. This can prevent autofocus being disabled by the clutch engaging accidentally.

- This item applies during both still photography and movie recording. See pages 128 and 356 for more information.

<b>Operative</b>	The camera responds to the position of the lens focus ring.
<b>Inoperative</b>	The camera focuses according to the option selected for [  AF Mode] or [  AF Mode], regardless of the position of the lens focus ring. Manual focus is not available even when the focus ring is in the manual focus position.



**A4** tab ➔ [MF Clutch] ➔ Choose an option

4

## **A4** Lens Focus Direction **(Focus Ring)**

Choose the direction in which the focus ring is rotated to adjust focus.

- This item applies during both still photography and movie recording.

	Rotate the ring counterclockwise to increase the focus distance.
	Rotate the ring clockwise to increase the focus distance.

**A4** tab ➔ [Focus Ring] ➔ Choose an option

## **A4** Adjusting Focus During Long Exposures (Bulb/Time Focusing)

You can change focus position manually when using bulb photography for a long exposure. This allows you to defocus during the exposure or focus at the end of the exposure. This option takes effect in mode **B**.

- This item is for still photography. See page 107 for more information.

<b>Off</b>	The focus position cannot be adjusted manually during an exposure.
<b>On</b>	The focus position can be adjusted manually during an exposure.

**A4** tab ➔ [Bulb/Time Focusing] ➔ Choose an option

## **A4** Resetting the Lens Position at Shutdown (Reset Lens)

You have the option of not restoring the lens to the reset focus position when the camera is turned off. This lets you turn the camera off without changing the focus position.

- This item applies during both still photography and movie recording.

<b>Off</b>	The lens focus position is not reset when the camera is turned off. Power zoom lenses also return to the zoom position they were in before the camera was turned off.
<b>On</b>	The lens focus position is reset when the camera is turned off.

**A4** tab ➔ [Reset Lens] ➔ Choose an option

## Control-Related Items

### (Custom Menus **B1** and **B2**)

These menus contain items used to customize camera buttons, dials, the multi selector, and switches.

#### **B1** Assigning Roles to Buttons (📷 Button Function)

Other roles can be assigned to buttons in place of their existing roles. Menu items can be assigned to buttons for quick access during shooting.

- This item is for still photography. The functions assigned to controls using this item are available only in modes **P**, **A**, **S**, **M**, and **B** (still photography modes).
- For more information, see “Assigning Roles to Buttons (📷 Button Function)” (P. 463) in “4-3 Customizing Buttons and Dials”.
- The functions assigned using [📹 Button Function] (P. 417) in the 📹 video menu take effect in 📹 (movie) mode.

#### Customizable Controls

Icon	Control (orientation)
	(exposure compensation) button
	ISO button
	(movie) button
	(LV) button
	Fn button
	AEL/AFL button
	WB button
	Arrow pad
	Arrow pad  (right)
	Arrow pad  (down)

Icon	Control (orientation)
	One-touch white balance button
	Preview button
	Vertical-use  (exposure compensation) button
	Vertical-use ISO button
	Vertical-use AEL/AFL button
	Vertical-use one-touch white balance button
	Vertical-use preview button
	L-Fn (the Fn buttons on the lens)

- B1** tab → [📷 Button Function] → Select a control using on the arrow pad  
→ Select a role using on the arrow pad

## **B1** Multi Selector Press (Center Button)

Choose the operation performed by pressing the multi selector. The multi selector can then function as a button.

- This item applies during both still photography and movie recording.

<b>Off</b>	No role assigned. Pressing the multi selector has no effect.
<b>[:::]</b> (AF target selection)	Press the multi selector to adjust settings for AF target selection, AF target mode, or face priority AF. The arrow pad or front and rear dials can be used according to the setting selected for <b>[:::]</b> Select Screen Settings] (P. 488) in <b>Custom Menu A2</b> .
<b>[:::]HP</b> (AF area HOME)	The multi selector functions as a <b>[:::] Home</b> button. This option applies in still photography modes only. <b>[:::] Button Function</b> (P. 463)

**B1** tab ➔ **[Center Button]** ➔ Choose an option

## **B1** Multi Selector Tilt (Direction Key)

Choose the operation performed by tilting the multi selector. The multi selector is normally used to position the AF target, but this function can be disabled to prevent unintended operation.



- This item applies during both still photography and movie recording.

<b>Off</b>	Pressing the multi selector up, down, left, or right has no effect.
<b>[:::]</b> (AF-target selection)	The multi selector can be used to position the AF-target (P. 123, 352).



**B1** tab ➔ **[Direction Key]** ➔ Choose an option

## **B1** Assigning Roles to the Front and Rear Dials ( Dial Function)

Choose the roles performed by the front and rear dials. You can also choose the function selected using the **Fn** lever. You can also choose the operations performed during playback or when menus are displayed.

- This item is for still photography. The functions assigned to controls using this item are available only in modes **P**, **A**, **S**, **M**, and **B** (still photography modes). See page 473 for more information. The functions assigned in the  video menu take effect in  (movie) mode (P. 424).

### **Available Roles**

- Ps (program shift)
- Shutter speed
- Aperture
- Exposure compensation
- Flash compensation
- ISO sensitivity
- WB mode
- CWB color temperature
- Off
- /Value (move cursor up or down)
-  (move cursor left or right)
-  (index/playback zoom)
- Frame advance/rewind

**B1** tab ➔ [ Dial Function] ➔ Select a mode ➔ Select a role

4

## **B1** Changing the Dial Direction (Dial Direction)

Choose the direction in which the dials are rotated to set exposure.

- This item applies during both still photography and movie recording.



<b>Exposure</b>	Choose the direction the dials are rotated to set aperture and shutter speed in <b>A</b> , <b>S</b> , <b>M</b> , and <b>B</b> modes.
<b>Ps</b>	Choose the direction the dials are rotated for program shift (mode <b>P</b> ).



**B1** tab ➔ [Dial Direction] ➔ Choose an option ➔ Choose a setting





## **B1** Assigning a Role to the Fn Lever (Fn Lever Function)

Choose the role performed by the **Fn** lever.

- This item is for still photography. The functions assigned to controls using this item are available only in modes **P**, **A**, **S**, **M**, and **B** (still photography modes). See page 475 for more information. The functions assigned in the  video menu take effect in  (movie) mode (P. 426).

<b>mode1</b>	Switch the functions of the front and rear dials. The functions for Positions 1 and 2 conform to the setting selected for  Dial Function] (P. 473).
<b>mode2</b>	Switch between two groups of settings previously selected for [AF Mode], [AF Target Mode], and [AF Target Point].
<b>mode3</b>	Toggle the shooting mode. You can switch to  (movie) mode without rotating the mode dial.
<b>Off</b>	Changing the position of the <b>Fn</b> lever has no effect.

**B1** tab →  Fn Lever Function] → Highlight an option and press the **OK** button.



- When [mode2] is highlighted, you can press  on the arrow pad to display AF settings.
- Available AF target modes are indicated by check marks (✓).
- The option selected for  Fn Lever Function] does not take effect in [mode3].

## **B1** Turning the Camera On or Off with the Fn lever (Fn Lever/Power Lever)



4

The **Fn** lever can be used as an on/off lever. Use this feature if you would like to use your right hand to turn the camera on or off during shooting.

- This item applies during both still photography and movie recording.



<b>Fn</b>	The lever functions according to the options selected for  Fn Lever Function] and  Fn Lever Function] (P. 426).
<b>Power 1</b>	The lever functions as an on/off lever. Position 1 is on and Position 2 is off.
<b>Power 2</b>	The lever functions as an on/off lever. Position 1 is off and Position 2 is on.

**B1** tab → [Fn Lever/Power Lever] → Choose an option

- The **ON/OFF** lever cannot be used to turn the camera off when [Power 1] or [Power 2] is selected.  Fn Lever Function] and  Fn Lever Function] are similarly unavailable.

## **B2** Power Zoom Lenses ( Elec. Zoom Speed)

Choose the speed at which power zoom lenses zoom in or out when the zoom ring is rotated. Adjust zoom speed if it is so quick that you find it hard to frame your subject. Choose from [Low], [Normal], and [High].

- This item is for still photography. The option selected for  Elec. Zoom Speed] in the  video menu takes effect in  (movie) mode (P. 408).

<b>Low</b>	Slow zoom. A good choice when precise adjustments are needed.
<b>Normal</b>	Normal zoom speed.
<b>High</b>	Fast zoom.

**B2** tab ➔  Elec. Zoom Speed] ➔ Choose an option

## B2 Configuring the Lock Lever

## (C-LOCK Settings)

Choose the controls locked when the lock lever on the back of the camera is set to **C-LOCK**. The lock lever can be used to lock controls and prevent them being used. In the **C-LOCK** position, you can choose the controls locked.

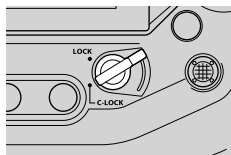

- This item applies during both still photography and movie recording.
- The controls that can be locked with the lock lever are listed below. The items in the **LOCK** column cannot be changed. The items in the **C-LOCK** column can be changed using this option.

Control	LOCK	C-LOCK
Front dial	—	✓
Rear dial	—	✓
ⓘ (BKT, AF, and flash/sequential shooting/self-timer) buttons	—	✓
Multi selector	—	✓
<b>Fn</b> lever	—	✓
Arrow pad	—	✓
<b>OK</b> button	—	✓
Touch screen	—	✓
Vertical-use shutter button	✓	✓
Vertical-use front dial	✓	✓
Vertical-use rear dial	✓	✓
Vertical-use exposure compensation button	✓	✓
Vertical-use <b>ISO</b> button	✓	✓
Vertical-use <b>AEL/AFL</b> button	✓	✓
Vertical-use multi selector	✓	✓

- The selected control is locked not only during shooting but also while settings are being adjusted, for example in the menus or LV super control panel.
- The role selected for the **Fn** lever cannot be changed while controls are locked.
- The lock does not apply to the **Fn** lever if it has been configured to act as an on/off lever using [Fn Lever/Power Lever] (P. 501).

- 1 Highlight [C-LOCK Settings] in the **B2** (Button/Dial/Lever) menu and press **▶** on the arrow pad.

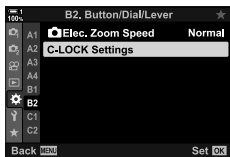

- 2 Highlight controls you want locked when the lock lever is the **C-LOCK** position and press the **OK** button.
- Selected items are marked with a **✓**. Selected items will be locked.

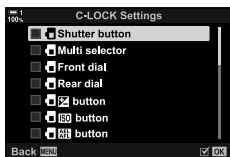

- 3 Press the **MENU** button repeatedly to exit when settings are complete.

## Release-Related Items (Custom Menus **C1** and **C2**)

These menus contain items used to customize features related to the shutter release, including burst shooting options.

### **C1** Choosing the Operation Performed If Focus Fails with [S-AF] Selected for [📷 AF Mode] (S-AF Release Priority)

Choose whether the camera will take a photograph if unable to focus with [S-AF] or [S-AF **MF**] selected for [📷 AF Mode].

- This item is for still photography.

<b>On</b>	A photo will be taken when the shutter button is pressed all the way down, even if the camera is unable to focus.
<b>Off</b>	No photo will be taken when the shutter button is pressed all the way down unless the camera is able to focus. If a flash is used, the shutter will not be released until the flash has charged.

**C1** tab ➔ [S-AF Release Priority] ➔ Choose an option

### **C1** Choosing the Operation Performed If Focus Fails with [C-AF] Selected for [📷 AF Mode] (C-AF Release Priority)

Choose whether the camera will take a photograph if unable to focus with [C-AF], [C-AF **MF**], [C-AF+TR], or [C-AF+TR **MF**] selected for [📷 AF Mode].

- This item is for still photography.



<b>On</b>	A photo will be taken when the shutter button is pressed all the way down, even if the camera is unable to focus.
<b>Off</b>	No photo will be taken when the shutter button is pressed all the way down unless the camera is able to focus. If a flash is used, the shutter will not be released until the flash has charged.

**C1** tab ➔ [C-AF Release Priority] ➔ Choose an option

# C1 [Sequential Low] Frame Rates and Burst Limits (L Settings)

Customize settings for [Sequential Low], [L Anti-Shock (♦)], [L Silent (♥)], and [Pro Capture Low] modes.

- This item is for still photography. For more information, see the pages listed below.

 (sequential low/anti-shock sequential low)	Choose the frame rate and maximum number of shots (P. 155). [Max fps]: 1–10 fps [Frame Count Limiter]: 2–99, Off (no limit)
 (silent sequential low)	Choose the frame rate and maximum number of shots (P. 155). [Max fps]: 1–10, 15, or 18 fps [Frame Count Limiter]: 2–99, Off (no limit)
 Pro Cap (Pro Capture low)	Choose the frame rate, the maximum number of shots taken before the shutter button is pressed all the way down, and maximum total shots (P. 168). [Max fps]: 10, 15, or 18 fps [Pre-shutter Frames]: 0–35 [Frame Count Limiter]: 0–99, Off (no limit) Includes shots captured before recording begins.

4

- 1 Highlight [L Settings] in the C1 (Release/Image Stabilizer) menu and press  $\blacktriangleright$  on the arrow pad.

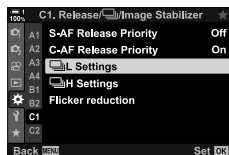

- 2 Highlight an option using the  $\Delta$   $\nabla$  buttons and press the  $\blacktriangleright$  button.



- 3 Highlight a sub-option using the  $\Delta$   $\nabla$  buttons and press the  $\blacktriangleright$  button.

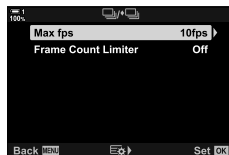

- 4 Highlight a setting using the  $\Delta$   $\nabla$  buttons and press the **OK** button.

- When choosing the [Frame Count Limiter] for [Pro Cap], highlight a value and press the  $\triangleright$  button. When prompted to choose the maximum number of shots, highlight a value using the  $\Delta$   $\nabla$   $\triangleleft$   $\triangleright$  buttons and press the **OK** button.

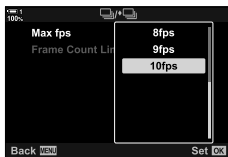



- 5 When settings are complete, press the **MENU** button repeatedly to exit the menus.

## [Sequential High] Frame Rates and Burst Limits ( H Settings)

Customize settings for [Sequential High], [ H Silent  $\heartsuit$ ], and [Pro Capture High] modes.

4

- This item is for still photography. For more information, see the pages listed below.

 (sequential high)	Choose the frame rate and maximum number of shots (P. 155). [Max fps]: 10–15 fps [Frame Count Limiter]: 2–99, Off (no limit)
 (silent sequential high)	Choose the frame rate and maximum number of shots (P. 155). [Max fps]: 15, 20, 30, or 60 fps [Frame Count Limiter]: 2–99, Off (no limit)
Pro Cap (Pro Capture high)	Choose the frame rate, the maximum number of shots taken before the shutter button is pressed all the way down, and maximum total shots (P. 168). [Max fps]: 15, 20, 30, or 60 fps [Pre-shutter Frames]: 0–35 [Frame Count Limiter]: 0–99, Off (no limit) Includes shots captured before recording begins.

- 1** Highlight [Image Stabilizer] in the **C1** (Release/Image Stabilizer) menu and press **▶** on the arrow pad.

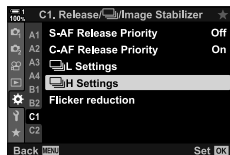

- 2** Highlight an option using the **▲▼** buttons and press the **▶** button.

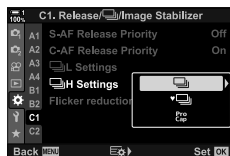

- 3** Highlight a sub-option using the **▲▼** buttons and press the **▶** button.

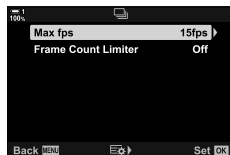

- 4** Highlight a setting using the **▲▼** buttons and press the **OK** button.

- When choosing the [Frame Count Limiter] for [Pro], highlight a value and press the **▶** button. When prompted to choose the maximum number of shots, highlight a value using the **▲▼** buttons and press the **OK** button.

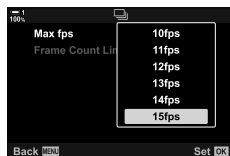

- 5** When settings are complete, press the **MENU** button repeatedly to exit the menus.



## **C1** Release Timing (Flicker Reduction)

When shooting under fluorescent or other artificial workplace or outdoor lighting, you may notice flicker in the live view display or uneven exposure in photos taken at fast shutter speeds. This item reduces these effects.

- For more information on flicker reduction, read the explanation on page 190.





<b>Anti-Flicker LV</b>	<p>Reduce flicker under fluorescent lighting and the like. Choose this option if flicker makes the display difficult to view.</p> <p>[Auto]: The camera detects and reduces flicker.</p> <p>[50Hz]: Reduce flicker under workplace or outdoor lighting powered by alternating current with a frequency of 50 Hz.</p> <p>[60Hz]: Reduce flicker under workplace or outdoor lighting powered by alternating current with a frequency of 60 Hz.</p> <p>[Off]: Flicker reduction off.</p>
<b>Anti-Flicker Shooting</b>	<p>The camera automatically detects the frequency of the flicker and times the shutter release appropriately. This item is for still photography. It applies to photos taken with the mechanical shutter.</p>

**C1** tab ➔ [Flicker reduction] ➔ Choose an option ➔ Choose a setting





- Enabling [Anti-Flicker Shooting] disables functions that use the electronic shutter, including silent mode, High Res Shot, and Pro Capture.
- Flicker detection may fail under some conditions. In this case, normal release timing will be used.
- Normal release timing is used at slow shutter speeds.
- Enabling [Anti-Flicker Shooting] may cause release lag, slowing the frame advance rate during burst photography.

## Reducing Camera Blur Image Stabilizer

Reduce blur caused by the camera shake that commonly occurs, for example, when the subject is poorly lit or in photos taken at high zoom ratios.



- This item is for still photography. See page 176 for more information. The option selected for [ AF/IS Settings] > [ Image Stabilizer] (P. 376) in the  video menu takes effect in  (movie) mode.

<b>S-IS Off</b>	Image stabilization disabled. Select this option when using a tripod.
<b>S-IS AUTO</b> (auto)	Image stabilization applies to motion on all axes. If panning motion is detected, the camera will automatically suspend image stabilization on that axis.
<b>S-IS</b> (multi-directional)	Image stabilization applies to all camera motion.
<b>S-IS</b> (vertical)	Image stabilization applies to motion at right angles to the camera base. Use when panning the camera horizontally.
<b>S-IS</b> (horizontal)	Image stabilization applies to motion parallel to the camera base. Choose when panning left or right with the camera in portrait (tall) orientation.

- When using lenses other than Micro Four Thirds or Four Thirds system lenses, you will need to specify the lens focal length. Press  on the arrow pad in the menu where you select an option, then use the     button to highlight a value and press the **OK** button. If the lens information saved with [Lens Info Settings] (P. 550) is used, the saved focal length will be applied.
- The setting selected with the lens image stabilization switch, if any, takes priority over that selected with the camera.

4



- You can choose whether image stabilization will be performed while the shutter button is pressed halfway.   Custom Menu  > [Half Way Rls With IS] (P. 178)

 tab  [ Image Stabilizer]  Choose an option

## **Burst Mode Image Stabilization** ( **Image Stabilization** )

Choose the type of image stabilization applied during burst shooting.

To maximize the effects of image stabilization during burst shooting, the camera centers the image sensor for every shot. This slightly reduces the frame advance rate.

- This item is for still photography. See page 174 for more information.

<b>IS Priority</b>	Priority is given to image stabilization. The frame advance rate drops slightly.
<b>Fps Priority</b>	Priority is given to the frame advance rate. Image stabilization may be slightly less effective under some conditions.

 tab ➔ [ Image Stabilization] ➔ Choose an option

## **Half-Press Image Stabilization** ( **Half Way RIs With IS** )

Choose whether image stabilization applies while the shutter button is pressed halfway. An example of a situation in which you might want to suspend image stabilization would be when using the level gauge to keep the camera level while framing photographs.

- This item is for still photography. See page 178 for more information.

<b>On</b>	Image stabilization is performed while the shutter button is pressed halfway.
<b>Off</b>	Image stabilization is not performed while the shutter button is pressed halfway.

 tab ➔ [Half Way RIs With IS] ➔ Choose an option

## Image Stabilization for IS Lenses (Lens I.S. Priority)

When using a third-party lens with an on-board image stabilizer, choose whether image stabilization gives priority to the camera or the lens. This option has no effect if the lens is equipped with an IS switch that can be used to enable or disable image stabilization.

- This item applies during both still photography and movie recording.

<b>On</b>	Priority is given to lens image stabilization.
<b>Off</b>	Priority is given to camera image stabilization.

 tab ➔ [Lens I.S. Priority] ➔ Choose an option

## Display-, Sound-, and Connection-Related Items (Custom Menus **D1**, **D2**, **D3**, and **D4**)

These menus contain items pertaining to the information displayed in the monitor and viewfinder to aid shooting, the choice of on-screen controls, the settings used for connection to external devices, and the like.

### **D1** Viewing On-Screen Controls (📷 Control Settings)

View or hide on-screen controls during shooting.

Use this option to hide on-screen controls (live controls and the LV super control panel) so that they cannot be displayed via the **INFO** button.

- This item is for still photography. The option selected for [📷 Display Settings] > [📷 Control Settings] in the 📷 video menu takes effect in 📷 (movie) mode. See page 428 for more information.
- For more information, see the section for each of the on-screen controls.

<b>Live Control</b>	Live controls are used to view and adjust core shooting settings during live view. The effects of the selected settings can be previewed in the live view display. For more information, see page 68.
<b>Live SCP</b>	The LV super control panel is used to list and adjust shooting settings. It can also be used to view current settings. For more information, see page 62.

- 1 Highlight [📷 Control Settings] in the **D1** (Disp/📷)/PC) menu and press **▶** on the arrow pad.

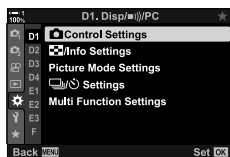

- 2 Highlight items using the **▲ ▼** buttons and press the **OK** button.
  - Selected items are marked with a **✓**. Selected items will be displayed.



- 3 When settings are complete, press the **MENU** button repeatedly to exit the menus.

## ■ Displaying On-Screen Controls

- 1 Press the **OK** button during live view in **P**, **A**, **S**, **M**, or **B** mode.
  - The LV super control panel will be displayed.



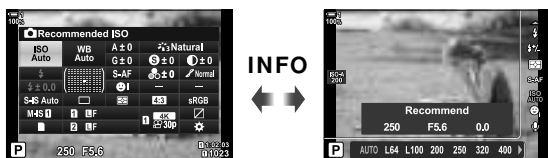

- 2 Press the **INFO** button to display live controls.
  - The on-screen controls displayed change each time the **INFO** is pressed.













- 3 After adjusting settings, press the **OK** button to exit the on-screen controls.
    - Pressing the **OK** button will in future display the last on-screen controls used.
- The **INFO** button cannot be used to toggle on-screen controls if it can be used to display options for the item currently selected in the live control display. Select a different item before using the **INFO** button to toggle the display.

## **D1** Choosing the Information Displayed with the INFO Button /Info Settings

The **INFO** button is used to select the content and type of the information displayed during shooting or playback. This option is used to choose the items displayed.

- This item applies during still photography and playback. The option selected for  Info Settings] in the  video menu applies in  (movie) mode (P. 429).

 <b>Info</b>	<p>Choose the info displayed during playback. Press the <b>INFO</b> button to cycle the displays in the chosen order when viewing photos.</p> <p>[Image Only]: Display images only.            [Overall]: Display a histogram and shooting info.  : Superimpose a histogram on the playback display.            [Highlight&amp;Shadow]: Use tints to indicate over- and under-exposed areas.            [Field Sensor Info]: Display GPS and other sensor data.            [Light Box]: Display two images side-by-side.</p>
 <b>Info</b>	<p>Choose the  (magnify) display for playback zoom.</p> <p>[Magnify Frame]: Display the zoom frame.            [Magnify Scroll]: Scroll the playback zoom display.            [Select Frame]: Display other images during playback zoom.</p>
<b>LV-Info</b>	<p>Choose the info shown in the live view shooting display. Available items include not only the level gauge and histogram, but also GPS and other sensor data. Customize the display to suit your preferences.  "Choosing the Information Displayed" (P. 84)</p> <p>[Image Only]: Info hidden.            [Custom1]/[Custom2]: Enable or disable the , [Highlight&amp;Shadow], and [Level Gauge] displays. You can choose the combination of indicators available.            [Field Sensor Info]: Display GPS and other sensor data.</p>
<b>LV OFF-Info</b>	<p>Display sensor data in the monitor in place of the LV super control panel.            [Field Sensor Info]: Display GPS and other sensor data.</p>
 <b>Settings</b>	<p>Choose the number of thumbnails displayed per page or enable the calendar display during index playback.</p> <p>4/9/25/100]: Choose the number of images displayed.            [Calendar]: Enable calendar playback.</p>

- 1 Highlight [Info Settings] in the **D1** (Disp/■)/PC) menu and press **▷** on the arrow pad.

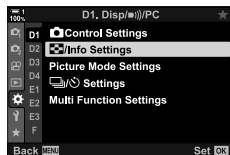

- 2 Highlight an item and press the **▷** button.

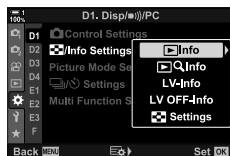

- 3 Highlight the items you wish displayed press the **OK** button.

- Selected items are marked with a **✓**. Selected items will be displayed.
- To choose the information displayed when the shutter button is pressed halfway, select [LV-Info], highlight [Image Only] and press the **▷** button.  
[On]: Shooting info is displayed while the shutter button is pressed halfway.  
[Off]: Shooting info is not displayed while the shutter button is pressed halfway.

Highlight the desired item and press the **OK** button to return to the [LV-Info] menu.

- Pressing the **▷** button when [Custom1] or [Custom2] is highlighted lists the displays available; highlight the desired items and press the **OK** button.

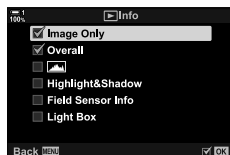

- 4 Press the **MENU** button repeatedly to exit when settings are complete.



## ■ Info: Available Displays

The displays corresponding to the different options are shown below. Press the **INFO** button to cycle the display during playback.

### Basic Info

Display a limited amount of shooting info.

- Basic info is displayed at all times, regardless of the option selected (P. 266).



### Image Only

Only images are displayed.



### Overall

Display all shooting settings, the histogram, and other information (P. 266).

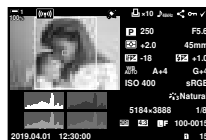

### (Histogram)

A histogram is superimposed on the playback display (P. 84).

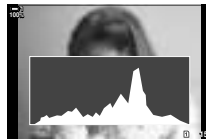

### Highlight&Shadow

Tints are added to show over- and under-exposed areas during playback (P. 84).





### Field Sensor Info

Display GPS and other sensor data (P. 574).



### Light Box

Compare two images side-by-side.  “ Info: The Light Box Display” (P. 518)



## ■ Info: The Light Box Display

Compare two images by displaying them side-by-side and zooming in and out.

**1** Press the  button.

- A picture will be displayed.



**2** Press the **INFO** button repeatedly until the light box is displayed.

- Two images will be displayed side-by-side.
- The picture that serves as the standard for comparison (the "base picture") is displayed on the left, the currently-selected picture on the right.



**3** Display the desired picture in the right box (the base picture).

- Rotate the front dial until the desired picture is displayed and press the **OK** button. The picture will appear in the left box.

**4** Choose the picture displayed in the right box.

- Rotate the front dial until the desired picture is displayed.
- To use the picture currently selected in the right box as the base picture, press the **OK** button.





**5** Press the **Fn** button to enable scrolling for the current picture (the picture in the right box).



- Use the arrow pad or the multi selector to scroll the current picture.
- Press the **Fn** button again to allow both pictures to be scrolled simultaneously.
- Use the rear dial to zoom both pictures in or out.





- The current picture (in the right box) can be selected () , protected, or marked for sharing using the same operations as in single-frame playback.

## ■ Info: Playback Zoom

A playback info settings option. It is used to choose the operations available during playback zoom. It also determines the behavior of the button to which  (magnify) has been assigned using the  Button Function] (P. 463) option.

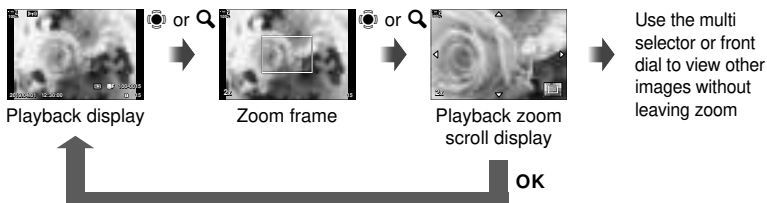
<b>Magnify Frame</b>	Pressing the multi selector or the control to which  (magnify) is assigned displays the zoom frame. If [Magnify Frame] is not checked (  ) , the camera will instead zoom in without first displaying the zoom frame.
<b>Magnify Scroll</b>	Scroll the image in the playback zoom display.
<b>Select Frame</b>	View other images during playback zoom.



- If no options are selected, zoom will not be available via the rear dial or the control to which  (magnify) is assigned.

## ■ Settings: Index Playback

Adjust settings for the index display, which is activated by rotating the rear dial toward  during playback. Choose the number of thumbnails displayed or enable calendar playback (P. 268).

The display changes each time the rear dial is rotated toward .

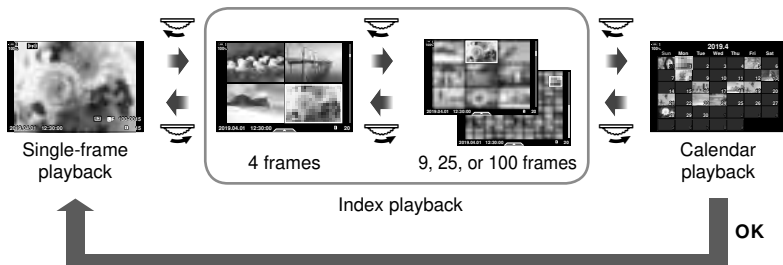

- If no options are selected, index and calendar playback using the rear dial will be disabled.

## **D1** Picture Mode Selection (Picture Mode Settings)

Limit the choice of picture modes to include only those you require. This applies to displays such as the live controls and LV super control panel.

- This item applies during both still photography and movie recording.
- See the relevant sections for information on the picture modes available for still photography (P. 215) and movie recording (P. 388).

**D1** tab ➔ [Picture Mode Settings] ➔ Highlight options and press the **OK** button

- Items indicated by check marks (✓) are displayed in picture mode menus.
- [Natural] is always available.

4

## **D1** Drive Mode Selection (Settings)

Limit the choice of drive (sequential shooting/self-timer) modes to include only those you require. This applies to displays such as the live controls and LV super control panel.

- This item is for still photography.
- For information on drive modes, see the explanation on page 151.

**D1** tab ➔ [Settings] ➔ Highlight options and press the **OK** button

- Items indicated by check marks (✓) are displayed in drive mode menus.
- [ ] (single frame) mode is always available.
- [Anti-Shock [♦]] (P. 160) and [Silent [♥]] (P. 163) must be enabled or disabled using [Anti-Shock [♦]/Silent [♥]].

## **D1** Multi Fn Display Options (Multi Function Settings)

Choose the functions available when accessing the multi-function feature.

- This item applies during both still photography and movie recording.
- For information on the multi-function feature, see the explanation on page 470.

**D1** tab ➔ [Multi Function Settings] ➔ Highlight options and press the **OK** button

- Items indicated by check marks (✓) are accessible via the multi-function toggle.
- [Highlight & Shadow Control] is always displayed.

## **D2** Live View Exposure Preview (Live View Boost)

Exposure settings such as exposure compensation can be previewed during live view. You can instead adjust brightness for ease of viewing under night skies and in other dark environments. Settings can be adjusted separately for mode **M**, long exposures, live composite photography, and the like.

- This item is for still photography.
- For information on live boost, see the explanation on page 200.

<b>Off</b>	Preview exposure in live view. Exposure can be previewed before shooting. <ul style="list-style-type: none"><li>• This option does not apply during bulb or time photography.</li></ul>
<b>On1</b>	Exposure preview disabled; brightness is adjusted for ease of viewing. The brightness of the preview differs from the final photograph.
<b>On2</b>	As for [On1] but brighter. Choose when framing shots of the night sky or the like. <ul style="list-style-type: none"><li>• The brightness of the preview differs from the final photograph. Subject motion may also appear slightly jerky.</li><li>• You can prioritize either the display rate or image quality according to the type of subject.</li></ul>

**D2** tab ➔ [Live View Boost] ➔ Choose a mode ➔ Choose options

- To view additional options when [On2] is highlighted, press **▷** on the arrow pad.
- The display rate slows if dark subjects are photographed with [Quality Priority] selected for [On2]. If [Frame Rate Priority] is selected, colors may be affected and the quality of the display will be reduced.

## **D2** Art Filter Preview **(Art LV Mode)**

You can preview the effects of art filters in the monitor or viewfinder during shooting. Some filters may cause subject movement to appear jerky, but this can be minimized so as to not influence photography.

- This item applies during both still photography and movie recording.

<b>mode1</b>	The effects of art filters can be previewed during shooting.
<b>mode2</b>	While the shutter button is pressed halfway, the camera gives priority to maintaining the display rate and reduces the effects of art filters on the preview display. Motion is smooth.

**D2** tab ➡ [Art LV Mode] ➡ Choose an option

4

## **D2** Viewfinder Display Rate **(Frame Rate)**

Choose the viewfinder display refresh rate. Choose a high frame rate to smooth the motion of fast-moving subjects.

- This item is for still photography.
- For information on the display rate, see the explanation on page 175.

<b>Normal</b>	The standard frame rate. This is the preferred choice in most situations.
<b>High</b>	Smooth the motion of fast-moving subjects. Fast-moving subjects are easier to track. This setting reverts to [Normal] automatically if the internal temperature of the camera rises during shooting.

**D2** tab ➡ [Frame Rate] ➡ Choose a mode ➡ Choose options

## **D2** Zoom AF Display Options (LV Close Up Settings)

Choose display options for use with focus zoom.

- This item applies during both still photography and movie recording.
- For information on live view zoom options, see the explanation on page 139.

<b>LV Close Up Mode</b>	<p>Choose what happens if the shutter button is pressed halfway during focus zoom.</p> <p>[mode1]: Focus zoom ends. You can check the composition after focusing using focus zoom.</p> <p>[mode2]: Focus zoom remains in effect while the camera focuses. Compose the shot before focusing, then zoom in for precise focus and take a picture without ever ending zoom.</p>
<b>Live View Boost</b>	<p>Choose whether the display brightens during focus zoom.</p> <p>[On]: The area in the zoom frame brightens for ease of viewing. Use for a clearer focus display during macro photography or the like.</p> <p>[Off]: Display brightness does not change. Exposure can be previewed during focus zoom.</p> <ul style="list-style-type: none"><li>• This option is available when [Off] is selected for [Live View Boost] (P. 521) in  Custom Menu <b>D2</b>.</li></ul>

**D2** tab ➔ [LV Close Up Settings] ➔ Choose an option ➔ Choose a setting

## **D2** Choosing the Playback Zoom Ratio ( Default Setting)

4

Choose the starting zoom ratio for playback zoom (close-up playback).

- This item applies during still photography and playback.

<b>Recently</b>	Zoom in to the most recently selected zoom ratio.
<b>Equally Value</b>	Images are displayed at a zoom ratio of 1:1. A  icon appears in the monitor.
<b>×2, ×3, ×5, ×7, ×10, ×14</b>	Choose the starting zoom ratio.



**D2** tab ➔ (   Default Setting) ➔ Choose an option

## D2 Depth-of-Field Preview

(Settings)

Choose the behavior of the control used for depth-of-field preview and adjust settings for the depth-of-field preview display.

- This item is for still photography.

 <b>Lock</b>	Choose the behavior of the control used for depth-of-field preview.  [Off]: Aperture stops down while the control is pressed. [On]: Aperture stops down when the control is pressed; to end depth-of-field preview, press the control a second time.
<b>Live View Boost</b>	Adjust settings for the depth-of-field preview display.  [Off]: The display uses the value metered for exposure before aperture was stopped down for the depth-of-field preview. You can preview changes to exposure that result from changes to aperture while depth-of-field preview is in effect. [On]: The display brightens for ease of viewing. The added brightness makes it easier to see how changes to aperture affect depth of field.  • This option is available when [Off] is selected for [Live View Boost] (P. 521) in  Custom Menu <b>D2</b> .









**D2** tab ➔  Settings] ➔ Choose an option ➔ Choose a setting

## D3 Framing Guide Options



(Grid Settings)

Guides can be displayed to assist composition. Select guide color and transparency and choose whether guides are shown in the viewfinder.

- This item applies during both still photography and movie recording.

<b>Display Color</b>	Adjust guide color and transparency. The camera can store up to two combinations of settings.
<b>Displayed Grid</b>	Select the type of guides displayed. Choose from: •  ,  ,  ,  ,  , and  • When  is selected, the guides are adjusted for a 16:9 movie frame when movies are shot in still photography mode. Depending on the option selected for  , the guides may be displayed with an aspect ratio of 17:9.
<b>Apply Settings to EVF</b>	Choose whether the option selected for [Displayed Grid] is reflected in the viewfinder display. The option selected for [EVF Grid Settings] in  Custom Menu <b>D1</b> (P. 556) has no effect.

**D3** tab ➔ [Grid Settings] ➔ Choose an option ➔ Choose a setting

- Use   on the arrow pad to choose a setting for [Display Color].
- The framing grid selected here is not displayed during focus stacking (P. 243).



## **D3** Focus Peaking Options (Peaking Settings)

Highlight objects using color outlines. This makes objects that are in focus easier to see during manual focus and the like.

- This item applies during both still photography and movie recording.

<b>Peaking Color</b>	Choose the focus peaking color.
<b>Highlight Intensity</b>	Choose the focus peaking level.
<b>Image Brightness Adj.</b>	Adjust background brightness to make focus peaking easier to see.

- When [On] is selected for [Image Brightness Adj.], the live view display may be brighter or darker than the final photograph.

**D3** tab ➔ [Peaking Settings] ➔ Choose an option ➔ Choose a setting

### ■ Using Focus Peaking

The following options are available for using focus peaking.

- **Assigning [Peaking Settings] to a control using [📷 Button Function] or [🎞️ Button Function]:**

Focus peaking can be assigned to a control by selecting [Peaking] for [📷 Button Function] (P. 463) or [🎞️ Button Function] (P. 417). Pressing the button enables focus peaking.

[Peaking] can also be selected for [Multi Function] (P. 470). In [🎞️] (movie) mode, [Peaking] is assigned to the [📷] (one-touch white balance) button by default.

- **Using [Peaking] for [MF Assist]:**

If [Peaking] is selected for [MF Assist], focus peaking will activate automatically when the lens focus ring is rotated. Press the **INFO** button to view peaking options. [📷] [MF Assist] (P. 495)

## **D3** Histogram Exposure Warning (Histogram Settings)

Choose the brightness levels that the histogram shows as overexposed (highlights) or underexposed (shadows). These levels are used for exposure warnings in the histogram displays during shooting and photo playback.

- This item applies during both still photography and movie recording.
- The areas shown in red or blue in the monitor and viewfinder [Highlight&Shadow] displays are also selected according to the values chosen for this option.

<b>Highlight</b>	Choose the minimum brightness for the highlight warning.
<b>Shadow</b>	Choose the maximum brightness for the shadow warning.

**D3** tab ➔ [Histogram Settings] ➔ Choose values using  $\Delta$   $\nabla$  on the arrow pad

4

## **D3** Shooting Mode Selection Help (Mode Guide)

Choose whether the camera displays help text when you rotate the mode dial to select a shooting mode.

<b>On</b>	Help is displayed.
<b>Off</b>	Help is not displayed.

**D3** tab ➔ [Mode Guide] ➔ Choose an option

## **D3** Selfie Assist **(Selfie Assist)**

Choose the display used when the monitor is reversed for self-portraits.

- This item applies during both still photography and movie recording.

<b>On</b>	When reversed for self-portraits, the monitor shows a mirror image of the view through the lens.
<b>Off</b>	The display does not change when the monitor is reversed.

**D3** tab ➔ [Selfie Assist] ➔ Use  $\Delta$   $\nabla$  to select [On] or [Off]

## **D4** Disabling the Focus Beep **( $\blacksquare$ )**

Disable the beep that sounds when the camera focuses.

<b>On</b>	A beep sounds after successful autofocus operations. The beep sounds only when the camera first focuses using [C-AF].
<b>Off</b>	A beep does not sound after successful autofocus operations.

**D4** tab ➔ [ $\blacksquare$ ] ➔ Choose an option

- You may need to adjust settings in the [Silent [ $\heartsuit$ ] Mode Settings] menu in order to enable the focus beep (P. 167).

## D4 External Monitor Display Options (HDMI)

Choose the signal output to external monitors connected via HDMI. Adjust the frame rate, movie frame size, and other settings according to monitor specifications.

- This item applies during both still photography and movie recording. See the relevant sections for details.  "External Monitor Display Options (HDMI)" (P. 434), "6-7 Connecting to TVs or External Displays via HDMI" (P. 626)

<b>Output Size</b>	Choose the type of signal output to the HDMI connector. [C4K]: The signal is output in 4K digital cinema (4096 × 2160) format. [4K]: If possible, the signal is output in 4K (3840 × 2160). [1080p]: If possible, the signal is output in Full HD (1080p). [720p]: If possible, the signal is output in HD (720p). [480p/576p]: The signal is output in 480p/576p format.
<b>HDMI Control</b>	Selecting [On] allows the camera to be controlled using a remote that supports HDMI control.
<b>Output Frame Rate</b>	Choose the signal frame rate according to whether the device supports NTSC or PAL.

D4 tab ➡ [HDMI] ➡ Choose an option ➡ Choose a setting

## **D4** Choosing a USB Connection Mode (USB Mode)

Choose how the camera functions when connected to external devices via USB.

- This item applies during both still photography and movie recording.

<b>Auto</b>	You will be prompted to choose a connection mode each time a USB cable is connected.
<b>Storage</b>	The camera functions as an external storage device. The data on the camera memory card can be copied to the computer.
<b>MTP</b>	The pictures on the memory card can be viewed or copied to the computer using standard software supplied with Windows Vista or later.
	The camera can be controlled from the computer, while pictures shot using OLYMPUS Capture can be downloaded as they are taken. For more information, see “6-5 Connecting to Computers via USB” (P. 620).
<b>PCM Recorder</b>	The camera can be connected to and control PCM recorders. For more information, see “Using the Olympus LS-100 IC Recorder” (P. 415) in “3-11 Audio Recording”.
<b>USB PD</b>	The camera can be powered by external devices connected via USB. For more information, see “6-6 Powering the Camera via USB (USB Power Delivery)” (P. 625).

**D4** tab ➔ [USB Mode] ➔ Choose an option

## Exposure-Related Items

### (Custom Menus **E1**, **E2**, and **E3**)

These menus contain exposure-related items. Included are items for customizing ISO sensitivity, bulb photography, and other functions.

#### **E1** EV Steps for Exposure Control (EV Step)

Choose the size of the increments used when adjusting shutter speed, aperture, exposure compensation, and other exposure-related settings. Choose from 1/3, 1/2, and 1 EV.

- This item applies during both still photography and movie recording.

**E1** tab ➔ [EV Step] ➔ Choose an option

4

#### **E1** EV Steps for ISO Sensitivity Control (ISO Step)

Choose the size of the increments used when adjusting ISO sensitivity. Choose from 1/3 and 1 EV.

- This item applies during both still photography and movie recording.

**E1** tab ➔ [ISO Step] ➔ Choose an option

## **E1** [📷 ISO] > [AUTO] Control Range (📷 ISO-Auto Set)

Choose the range of ISO sensitivity values selected by the camera and the shutter speed at which auto ISO sensitivity control takes effect when [AUTO] is selected for [📷 ISO].

- This item is for still photography. See page 183 for more information.
- The option selected for [📷M ISO-Auto Set] in the [📷] video menu takes effect in [📷] (movie) mode (P. 372).

<b>Upper Limit / Default</b>	[High Limit]: Choose the maximum sensitivity selected automatically by the camera. [Default]: Choose the default sensitivity. <ul style="list-style-type: none"><li>• The maximum is 6400. Sensitivity may drop below the default value if optimal exposure cannot be achieved at the current aperture and shutter speed.</li></ul>
<b>Lowest S/S Setting</b>	Choose the shutter speed at which the camera will start to raise ISO sensitivity when [AUTO] is selected for [📷 ISO]. This option takes effect in modes <b>P</b> and <b>A</b> . Select [Auto] to let the camera choose the minimum shutter speed automatically.

**E1** tab ➔ [📷 ISO-Auto Set] ➔ Choose an option ➔ Choose a setting

## **E1** [📷 ISO] > [AUTO] Availability (📷 ISO-Auto)

Choose the shooting modes in which auto ISO sensitivity control will take effect when [AUTO] is selected for [📷 ISO]. Choose whether auto ISO sensitivity control is available in modes **P**, **A**, **S**, and **M** or only in modes **P**, **A**, and **S**.

- This item is for still photography. See page 185 for more information.

<b>P/A/S</b>	[📷 ISO] > [AUTO] takes effect only in modes <b>P</b> , <b>A</b> , and <b>S</b> . If [AUTO] is in effect when mode <b>B</b> is selected, [📷 ISO] will be set to ISO 200.
<b>All</b>	[📷 ISO] > [AUTO] takes effect only in modes <b>P</b> , <b>A</b> , <b>S</b> , and <b>M</b> .

**E1** tab ➔ [📷 ISO-Auto] ➔ Choose an option

## **E1** High [📷 ISO] Noise Reduction Options (📷 Noise Filter)

Reduce image artifacts (“noise”) in pictures taken at high ISO sensitivities. This can help reduce “graininess” in photos shot under low light. You can choose the amount of noise reduction performed.

- This item is for still photography.
- The option selected for [📷 Noise Filter] in the 📷 video menu takes effect in 📷 (movie) mode (P. 379).

<b>Off</b>	Noise reduction is not performed.
<b>Low/Standard/High</b>	Choose the amount of noise reduction performed.

**E1** tab ➔ [📷 Noise Filter] ➔ Choose an option

4

## **E1** Image Processing Options (📷 Low ISO Processing)

Choose the type of processing applied to photographs taken at low ISO sensitivities.

- This item is for still photography.

<b>Drive Priority</b>	Image processing is adapted so as not to curtail the number of pictures that can be taken in a single burst.
<b>Detail Priority</b>	Image processing prioritizes image quality.

**E1** tab ➔ [📷 Low ISO Processing] ➔ Choose an option



## **E1** Long Exposure Noise Reduction Options (Noise Reduct.)

Choose whether to process photos taken at slow shutter speeds to reduce image artifacts ("noise"). At slow shutter speeds, noise is caused by the heat generated from the camera itself. After each photo is taken, the camera captures a second image for noise reduction, causing a delay equal to the selected shutter speed before the next photo can be taken.

- This item is for still photography.

<b>Off</b>	Noise reduction not performed.
<b>On</b>	Noise reduction is performed at all shutter speeds.
<b>Auto</b>	Noise reduction is performed automatically when the camera's internal temperature is elevated.

- During noise reduction, the camera displays the time remaining until the process is complete.
- During sequential shooting, [Off] is selected automatically and noise reduction is not performed.
- Noise reduction may not produce the desired effects depending on the subject and shooting conditions.

**E1** tab ➔ [Noise Reduct.] ➔ Choose an option

## **E2** Choosing the Maximum Time for Long Exposures (Bulb/Time Timer) **4**

Choose the maximum exposure time for **B** (bulb) mode. The shutter will close automatically when the selected limit is reached.

- This item applies during still photography when [BULB] or [TIME] is selected in mode **B** (bulb).
- Choose from the following options:  
1 minute/2 minutes/4 minutes/8 minutes/15 minutes/20 minutes/25 minutes/  
30 minutes

**E2** tab ➔ [Bulb/Time Timer] ➔ Choose an option

## **E2** Long Exposure Display Brightness (Bulb/Time Monitor)

Choose the brightness of the monitor when shooting in **B** (bulb) mode. The monitor can be brightened for ease of viewing in the dark conditions typical of bulb photography.

- This item applies during still photography in **B** (bulb) mode.
- Choose from values between -7 and +7.

**E2** tab ➔ [Bulb/Time Monitor] ➔ Choose an option

4

## **E2** Live Bulb Update Frequency (Live Bulb)

Choose the frequency with which the display is updated during live bulb photography in mode **B** (bulb). The display will be refreshed at the selected interval while live bulb photography is in progress, allowing you to view the results in the display.

- This item applies during still photography in **B** (bulb) mode. See page 104 for more information on live bulb photography.

**E2** tab ➔ [Live Bulb] ➔ Choose an option

- [Live Bulb] options can also be displayed by pressing the **MENU** button during [BULB] or [LIVE BULB] photography.

## **E2** Live Time Update Frequency (Live Time)

Choose the frequency with which the display is updated during live time photography in mode **B** (bulb). The display will be refreshed at the selected interval while live time photography is in progress, allowing you to view the results in the display.

- This item applies during still photography in **B** (bulb) mode. See page 104 for more information on live time photography.

**E2** tab ➔ [Live Time] ➔ Choose an option

- [Live Time] options can also be displayed by pressing the **MENU** button during [TIME] or [LIVE TIME] photography.

## **E2** Composite Photography Shutter Speed (Composite Settings)

Choose the shutter speed for composite photography in **B** (bulb) mode. Composite photography combines multiple photographs. This item is used to choose the shutter speed.

- Live composite photography can continue for up to three hours.
- This item applies during still photography in **B** (bulb) mode. See page 110 for more information on composite photography.

**E2** tab ➔ [Composite Settings] ➔ Choose an option

- [Composite Settings] options can also be displayed by pressing the **MENU** button in [LIVE COMP] mode.

## **E2** Reducing Flicker Under LED Lighting (📷 Flicker Scan)

Adjust shutter speed while viewing the display to eliminate banding under LED lighting.

Banding may occur in photographs taken under LED lighting. Use [📷 Flicker Scan] to optimize shutter speed while viewing banding in the display.

This item can be used in **S**, **M**, and silent mode and with High Res Shot and Pro Capture photography.

- The range of available shutter speeds is reduced.
- This item is for still photography. See page 193 for more information. The option selected for [📷 Flicker Scan] in the 📷 video menu takes effect in 📷 (movie) mode (P. 374).





**E2** tab ➔ [📷 Flicker Scan] ➔ Choose an option

4

## **E3** Exposure Metering (Metering)

Choose the method used to measure subject brightness.

- This item is for still photography. See page 186 for more information.
- [📷] (digital ESP metering) is used in 📷 (movie) mode.

 (digital ESP metering)	The camera sets exposure based on metering data from 324 areas of the frame.
 (center-weighted averaging)	The camera sets exposure based on the average light level for the entire frame while assigning the greatest weight to the area in the center.
 (spot metering)	The camera meters a small portion (approximately 2%) of the frame.
 (spot highlight metering)	Brightens the spot metering area, brightening highlights.
 (spot shadow metering)	Darkens the spot metering area, darkening shadows.





**E3** tab ➔ [Metering] ➔ Choose an option

- Metering can also be selected via a direct button (the **AF**  button), live controls, or the LV super control panel.

## **E3** AE Lock Exposure Metering (AEL Metering)

Choose the metering method used to meter exposure when exposure is locked using the **AEL/AFL** button. This allows you to use metering method when exposure is locked by pressing the shutter button halfway and another when exposure is locked by pressing the **AEL/AFL** button.



- This item is for still photography. For more information on AE lock, see page 188.

<b>Auto</b>	Exposure is metered using the method selected for [Metering] (P. 536).
 (center-weighted averaging)	The camera sets exposure based on the average light level for the entire frame while assigning the greatest weight to the area in the center.
 (spot metering)	The camera meters a small portion (approximately 2%) of the frame.
 (spot highlight metering)	Brightens the spot metering area, brightening highlights.
 (spot shadow metering)	Darkens the spot metering area, darkening highlights.

**E3** tab ➔ [AEL Metering] ➔ Choose an option

## **E3** Metering the Focus Target ([] Spot Metering)

Choose whether the camera meters the current AF target when [] is selected for [Metering]. Settings can be adjusted separately for spot, spot highlight, and spot shadow metering.

- This item is for still photography.
- [ Face Priority] turns off automatically.
- The selected option takes effect when [] (single target) or []s (small target) is selected as the AF-target mode (P. 120).
- The camera zooms in on the selected AF target during focus zoom (P. 136).



**E3** tab ➔ [] Spot Metering ➔ Choose an option

- Highlight the desired metering method and press the **OK** button. Selected methods are marked with a .

## **E3** Fine-Tuning Exposure (Exposure Shift)

Fine-tune exposure. Use this option if you want the results of auto exposure to be consistently brighter or darker.

- This item applies during both still photography and movie recording.
- Fine-tuning is not normally required. Use only as necessary. In normal circumstances, exposure can be adjusted using exposure compensation (P. 180, 367).
- Fine-tuning exposure reduces the amount of exposure compensation available in the direction (+ or -) exposure was fine-tuned.
- Exposure fine-tuning can be applied to the following metering methods.

Metering	Fine-tuning amount
 (digital ESP)	-1 to +1 EV in steps of 1/6 EV
 (center-weighted averaging)	
 (spot)	

**E3** tab ➔ [Exposure Shift] ➔ Choose an option ➔ Choose a value

This menu contains flash-related items. It includes flash sync settings and options for remote flash photography in RC mode.

## **F** Choosing a Flash Sync Speed (⚡X-Sync.)

Choose the fastest shutter speed available for flash photography.

Choose the fastest shutter speed available for flash photography, irrespective of subject brightness.

- This item is for still photography. See page 260 for more information.

**F** tab → [⚡X-Sync.] → Choose an option

## **F** Choosing the Minimum Shutter Speed (⚡Slow Limit)

Choose the slowest shutter speed available for flash photography.

This item is used to select the slowest setting available to the camera when selecting the shutter speed automatically during flash photography, regardless of how dark the subject may be. It does not take effect in slow-sync (⚡Slow, ⚡Slow2, and 📷Slow) modes.

- **Available values:** 30 s to value selected for [⚡X-Sync.]
- This item is for still photography. See page 261 for more information.

**F** tab → [⚡Slow Limit] → Choose an option

## **F** Flash and Exposure Compensation (⚡+⌘)

Choose whether exposure compensation is added to the value for flash compensation. For information on flash compensation, see page 259.

- This item is for still photography.

<b>Off</b>	Flash and exposure compensation are set independently.
<b>On</b>	The value for exposure compensation is added to the value for flash compensation.

**F** tab ⇒ [⚡+⌘] ⇒ Choose an option

4

## **F** Flash White Balance (⚡+WB)

Choose the white balance used for photos taken with a flash. Instead of using a setting adapted to flash lighting, you can opt to prioritize the value selected for non-flash photography. Use this option to automatically switch from one white balance setting to another when you find yourself frequently enabling and disabling the flash.

- This item is for still photography.

<b>Off</b>	The camera uses the value currently selected for white balance.
<b>WB AUTO</b>	The camera uses auto white balance ([Auto]).
<b>WB ⚡</b>	The camera uses flash white balance ([WB ⚡]).

**F** tab ⇒ [⚡+WB] ⇒ Choose an option



## **F** Wireless Remote Flash Control (⚡ RC Mode)

Adjust settings for wireless remote flash control. Remote control is available with optional flash units that support wireless remote control ("wireless RC flash"). For information on using wireless remote flash control, see page 262.

- This item is for still photography.

<b>Off</b>	Wireless remote flash control disabled.
<b>On</b>	Wireless remote flash control enabled. The camera displays settings for wireless remote flash control.

**F** tab ➔ [⚡ RC Mode] ➔ Choose an option

- Selecting [On] displays the RC mode LV super control panel in the camera monitor. To view the regular LV super control panel, press the **INFO** button.

# Image Quality, White Balance, and Color-Related Items (Custom Menu **G**)

This menu contains image-enhancement items, including options for fine-tuning white balance and for selecting image quality and size.

## **G** Image Quality and Size

(**←** Set)

Choose the image size and compression (quality) options available in the [**📷** **←**] menu (P. 78). The camera can store up to four image quality and size combinations ([**←**-1] to [**←**-4]).

- This item is for still photography. See page 81 for more information.

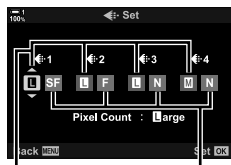

Image size

Compression ratio

The following options are available.

### Image Size (Pixels)

<b>L</b> (Large)	5184 × 3888
<b>M</b> (Medium)*	3200 × 2400
<b>S</b> (Small)*	1280 × 960

### Compression Ratio

<b>SF</b> (Super Fine)	1/2.7
<b>F</b> (Fine)	1/4
<b>N</b> (Normal)	1/8

\* The values for [**M**] and [**S**] are defaults and can be changed using **⚙** Custom Menu **G** → [Pixel Count] (P. 82).

**G** tab → [**←** Set] → Choose an option

## **G** Choosing Values for [M] and [S] Sizes (Pixel Count)

Choose the size, in pixels, of the [M] (Middle) and [S] (Small) [📷↔️] options (P. 78).

- This item is for still photography. See page 82 for more information.

The sizes available for the [M] and [S] options are:

<b>M</b> iddle (medium)	3200×2400, 1920×1440
<b>S</b> mall (small)	1280×960, 1024×768

**G** tab ➔ [Pixel Count] ➔ [M]iddle or [S]mall ➔ Choose a setting

## **G** Peripheral Illumination (Shading Comp.)

Compensate for the drop in brightness at the edges of the frame due to the optical characteristics of the lens. Some lenses may exhibit a drop in brightness at the edges of the frame. The camera can compensate for this by making the edges brighter.

- This item applies during both still photography and movie recording.

<b>Off</b>	Shading compensation disabled.
<b>On</b>	The camera detects and compensates for reduced peripheral illumination.

- [On] has no effect when a teleconverter or extension tube is attached.
- Noise may be more noticeable at the edges of the frame at high ISO sensitivities.

**G** tab ➔ [Shading Comp.] ➔ Choose an option

Compensate for changes in color due to the color of the light source. White balance makes white objects look white. Although [Auto] works well in most situations, you can choose an option suited to the light source if [Auto] fails to make white objects appear white or if instead you wish to deliberately lend white objects a color cast.

- This item is for still photography. See page 202 for more information. The option selected for WB in the video menu takes effect in (movie) mode (P. 380).

White balance mode	Color temperature	Choose for
Auto white balance	<b>Auto</b> —	Most normal scenes (scenes containing objects that are white or close to white) <ul style="list-style-type: none"> <li>• This mode is recommended in most situations.</li> </ul>
Preset white balance		5300 K Sunlit outdoor scenes, sunsets, fireworks
		7500 K Daylight shots of subjects in the shade
		6000 K Shots taken in daylight under overcast skies
		3000 K Subjects under incandescent lighting
		4000 K Subjects under fluorescent lighting
		— Underwater photography
		5500 K Flash photography
One-touch white balance	 Value selected for one-touch white balance	Subjects containing white or gray areas that can be used to measure white balance and that are under mixed lighting or lit by a flash with unknown characteristics
Custom white balance	<b>CWB</b> 2000 K–14000 K	Situations in which you can identify the appropriate color temperature

- Fine-tuning is available for each mode. White balance can be fine-tuned on the A (amber–blue) and G (green–magenta) axes.
- One-touch white balance can be used to choose from previously-selected values. For more information on one-touch white balance, see page 207.
- Custom white balance offers settings of from 2000 to 14000 K.

## G tab → WB → Choose an option

- When custom white balance (CWB) is highlighted, you can press on the arrow pad and use the buttons to choose the color temperature.
- To fine-tune white balance, highlight an option, press the button to display fine-tuning options, and then make the desired adjustments.
- Press the (movie) button in the A or G fine-tuning display to preview the effect in the monitor. Press the button again to return to the A or G fine-tuning display.
- White balance can be adjusted using a direct button (the **WB** button), the LV super control panel, or live controls. The same controls can be used to adjust white balance in (movie) mode.

## **G** Fine-Tuning [ WB] ( All )

Fine-tune white balance across the board. White balance is set by choosing a mode that matches the light source; this item fine-tunes all modes by the same amount.

- This item is for still photography. The option selected for [ All ] takes effect in mode (P. 385).

<b>All Set</b>	Fine-tune white balance for all modes. White balance can be fine-tuned on the A (amber–blue) and G (green–magenta) axes.
<b>All Reset</b>	Reset fine-tuning for all modes to default values.

**G** tab → [ All ] → Choose an option

- After selecting [All Set], fine-tune white balance on the A and G axes. After selecting [All Reset], highlight [Yes] and press the **OK** button.

## **G** Preserving Warm Colors Under Incandescent Lighting ( <sup>WB</sup><sub>AUTO</sub> Keep Warm Color )

4

When [Auto] is selected for [ WB], you can opt to preserve the warm colors seen under incandescent lighting. Although white balance will still be automatically adjusted for the light source, the warm colors produced by incandescent lighting will be preserved.

- This item is for still photography. The option selected for [ <sup>WB</sup><sub>AUTO</sub> Keep Warm Color] takes effect in mode (P. 383).

<b>On</b>	Preserve warm colors under incandescent lighting.
<b>Off</b>	Do not preserve warm colors under incandescent lighting.

**G** tab → [ <sup>WB</sup><sub>AUTO</sub> Keep Warm Color] → Choose an option

## **G** Choosing a Color Space (Color Space)

Choose a color space to ensure accurate color reproduction when photos are output to a printer or external display.

- This item is for still photography. See page 232 for more information.

<b>sRGB</b>	A color space established as the standard for Windows computers. It is used in standard displays, printers, digital cameras, and applications. This option is recommended in most situations.
<b>AdobeRGB</b>	A color space standard defined by Adobe Systems. It reproduces a wider gamut of colors than sRGB. Compliant software and displays, printers, and other equipment that support this standard are required for accurate color reproduction. An underscore (“_”) appears at the beginning of the file name (e.g., “_xxx0000.jpg”).

- [AdobeRGB] is not available in art filter picture modes or during HDR photography. [sRGB] is selected instead.

**G** tab ➔ [Color Space] ➔ Choose an option





# Storage- and Deletion-Related Items

## (Custom Menus **H1** and **H2**)

These menus contain items pertaining chiefly to the storage and deletion of the image data recorded with the camera.

### **H1** Card Slot Selection (Card Slot Settings)

The camera has slots for two memory cards. Choose a role for the card in each slot. For more information, see “2-3 Card-Related Settings” (P. 71) and “3-3 Card-Related Settings” (P. 316).

 <b>Save Settings</b>	Choose how the camera saves photos when two memory cards are inserted. Choose standard, overflow, split, or backup storage. You can opt to record each picture twice, once to each memory card and with each of the two copies in a different format, or to record pictures to only one card at a time, switching to the remaining card automatically when the first card is full (P. 72).
 <b>Save Slot</b>	Choose the card used to record photos when two cards are inserted (P. 74). This option is available when [□] (Standard) or [□] (Auto Switch) is selected for [📷 Save Settings].
 <b>Save Slot</b>	Choose the card used to record movies when two cards are inserted (P. 316).
 <b>Slot</b>	Choose the card used for playback when two memory cards are inserted. Pressing the [▶] button displays the images on the selected card (P. 57, 302). This option is not available if [□] (Standard) or [□] (Auto Switch) is selected for [📷 Save Settings].
<b>Assign Save Folder</b>	Choose the folder used to store image data. <ul style="list-style-type: none"><li>• This option is also available when only one card is inserted.</li><li>• This option applies to both photos and movies (P. 76, 319).</li></ul>

4

- The card used for playback or to record new photos and movies can be chosen by:
  - Pressing the **CARD** button and then rotating the front or rear dial
  - Holding the [▶] button and rotating the front or rear dialThis does not change the option selected for [▶ Slot].
- The option selected for image quality may change if you switch cards by changing settings or inserting or removing cards when [Dual Independent ↓□] or [Dual Independent ↑□] is selected for [📷 Save Settings]. Check the option selected for image quality before shooting.
- Settings other than [📷 Save Slot] and [Assign Save Folder] can only be accessed in still photography modes.

**H1** tab ➡ [Card Slot Settings] ➡ Choose an option ➡ Choose a setting

- When [□] (Auto Switch) is selected for [📷 Save Settings], the camera will automatically switch between the last picture on the first card and the first picture on the second card.
- In [📷 (movie) mode], the slot selected for [📷 Save Slot] also serves as the [▶ Slot].

## H1 File Naming Options (File Name)

Choose how the camera names files when saving photos or movies to memory cards. Filenames consist of a four-character prefix and a four-digit number. Use this option to choose how file numbers are assigned.

- When two cards are inserted, the camera may create new folders or fail to number files consecutively depending on the file and folder numbers currently in use on each card.

<b>Auto</b>	When a new memory card is inserted, file numbering continues from the last number used. If the card already contains a file with the same or a higher number, numbering will continue from the highest number.
<b>Reset</b>	Folder numbering is reset to 100 and file numbering to 0001 when a new card is inserted. If the card already contains images, numbering will continue from the highest number.

H1 tab ➔ [File Name] ➔ Choose an option

4

## H1 Naming Files (Edit Filename)

Choose how the camera names files when saving photos and movies to memory cards. File names consist of a four-letter prefix followed by a four-digit file number. You can change the prefix as desired. The editable portion varies with the option selected for [Color Space] (P. 232).

**[sRGB] selected for [Color Space]:**

**Pmdd0000.jpg** — The "Pmdd" portion can be changed

**[AdobeRGB] selected for [Color Space] (photos only):**

**\_mdd0000.jpg** — The "mdd" portion can be changed

H1 tab ➔ [Edit Filename] ➔ Choose an option ➔ Choose a setting

- Select [Off] to use the default prefixes.



## H1 Output Resolution (dpi Settings)

Choose the output resolution information (in dots per inch, or dpi) stored with photo image files. The selected resolution will be used when the images are printed.

- This item is for still photography.

H1 tab ➔ [dpi Settings] ➔ Choose the desired setting

## H1 Adding Copyright Information (Copyright Settings)

Choose the copyright information stored with photos when they are saved. Copyright information is stored as Exif tags.

- This item is for still photography.

Olympus will not be held liable for any disputes or damages arising from use of the [Copyright Settings] feature. Use at your own risk.

<b>Copyright Info.</b>	Add Exif tags naming the photographer and/or copyright holder.
<b>Artist Name</b>	Enter the name of the photographer.
<b>Copyright Name</b>	Enter the name of the copyright holder.

H1 tab ➔ [Copyright Settings] ➔ Highlight an option and press  $\triangleright$  on the arrow pad

- [Copyright Info.]: Highlight [Off] or [On] and press the **OK** button.
- [Artist Name]/[Copyright Name]: Highlight and press the  $\triangleright$  button to view the text entry display.

### Entering the Photographer/Copyright Holder Name

- 1) Highlight letters and press the **OK** button.
  - The letters will appear in the text display area.
  - To delete the current character, press the  $\text{⏏}$  button.
- 2) To delete previously-entered characters, press the **INFO** button to position the cursor in the text display area.
  - Highlight letters and press the  $\text{⏏}$  button to delete.
- 3) Highlight [END] and press the **OK** button when entry is complete.



Use the front or rear dial, arrow pad, or multi selector to position the cursor.

## **H1** Saving Lens Data (Lens Info Settings)

Add user-specified lens data to image Exif data. You can add information as necessary when using lenses that do not supply lens data to the camera. The camera can store information for up to 10 lenses. These data also supply the focal length used for the image stabilization and keystone compensation features.

- This item is for still photography.

<b>Create Lens Information</b>	Enter the desired information. You can specify the lens name, focal length, and maximum aperture.
<b>1-10</b>	View previously-saved lens data.

### ■ Saving Lens Data

**H1** tab ➔ [Lens Info Settings] ➔ Highlight [Create Lens Information] and press **▷** on the arrow pad

- [Lens Name]: Highlight and press the **▷** button to view the text entry display.
- [Focal Length]/[Aperture Value]: Highlight and press the **▷** button to view options. Choose a value using the arrow pad and press the **OK** button.

#### Entering Lens Names

- 1) Highlight letters and press the **OK** button.
  - The letter will appear in the text display area.
  - To delete the current character, press the **✖** button.
- 2) To delete previously-entered characters, press the **INFO** button to position the cursor in the text display area.
  - Highlight letters and press the **✖** button to delete.
- 3) Highlight [END] and press the **OK** button when entry is complete.

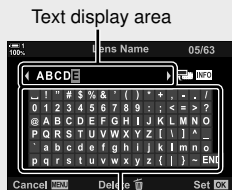

Use the front or rear dial, arrow pad, or multi selector to position the cursor.

### ■ Appending Lens Data to Image Information

If the camera is unable to obtain lens data from the current lens, you can instead supply previously-saved lens data.

**H1** tab ➔ [Lens Info Settings] ➔ Highlight the lens name and press the **OK** button



- The selected lens is indicated by a **✓**.



- [Lens Info Settings] can be assigned to a camera control using [📷 Button Function] (P. 463) or [🔍 Button Function] (P. 417). Lens info can be selected when, for example, you change lenses.

## H2 Disabling Deletion Confirmation (Quick Erase)

If this option is enabled when the  button is pressed to delete photos or movies, the camera will not display a confirmation dialog but will instead delete the images immediately.

Off	A confirmation dialog is displayed when the  button is pressed.
On	No confirmation dialog will be displayed when the  button is pressed.

H2 tab ➔ [Quick Erase] ➔ Choose an option

## H2 RAW+JPEG Deletion Options (RAW+JPEG Erase)

Choose operation performed when [RAW+JPEG] images are deleted one at a time.

JPEG	Only the JPEG copy is deleted.
RAW	Only the RAW copy is deleted.
RAW+JPEG	Both the RAW and JPEG copies are deleted.

- When [RAW+JPEG] pictures are erased using [All Erase] (P. 276) or [Erase Selected] (P. 279), both the RAW and the JPEG copies will be deleted.

H2 tab ➔ [RAW+JPEG Erase] ➔ Choose an option

## **H2** [Yes]/[No] Default (Priority Set)

Choose the option highlighted by default when a [Yes]/[No] confirmation is displayed.

<b>No</b>	[No] is highlighted by default.
<b>Yes</b>	[Yes] is highlighted by default.

**H2** tab ➔ [Priority Set] ➔ Choose an option

This menu contains items pertaining to the electronic viewfinder (EVF) display.

- “EVF” stands for “electronic viewfinder”.

## **1** Automatic Display Selection (EVF Auto Switch)

Choose whether the camera switches automatically between the viewfinder and monitor live view.

- This item applies during both still photography and movie recording. For more information, see “2 Taking and Viewing Photographs” (P. 51) and “3 Shooting and Viewing Movies” (P. 293).

<b>On</b>	The display switches automatically when you put your eye to the viewfinder.
<b>Off</b>	Press the <b>[ ]</b> button to switch between the monitor and viewfinder.

**1** tab ➔ [EVF Auto Switch] ➔ Choose an option



## **1** Viewfinder Brightness and Hue (EVF Adjust)

Adjust viewfinder brightness and hue. The display switches to the viewfinder while these settings are being adjusted.

- This item applies during both still photography and movie recording.

<b>EVF Auto Luminance</b>	[On]: Viewfinder brightness and indicator contrast adapt automatically to ambient lighting conditions. The [EVF Adjust] >  (brightness) option is not available. [Off]: Adjust settings using [EVF Adjust].
<b>EVF Adjust</b>	Adjust EVF display settings manually. Choose the display color temperature and choose a setting for brightness of from +7 to -7.

**1** tab ➔ [EVF Adjust] ➔ Choose an option ➔ Choose a setting

- After selecting [EVF Auto Luminance], highlight [On] or [Off] and press the **OK** button.
- The viewfinder turns on automatically when you select [EVF Adjust]. Highlight  (brightness) or  (color temperature) using **<D>** on the arrow pad and use the **Δ** **▽** buttons to choose a value.

# I Viewfinder Display Style (EVF Style)

Choose the viewfinder display style.

- This item applies during both still photography and movie recording.
- For information on the display, see pages 83 (photo mode) and 326 (movie mode).
- For more information on the content of the viewfinder display, see “Viewfinder (Still Photography)” (P. 88) or “Viewfinder (Movie Recording)” (P. 330).

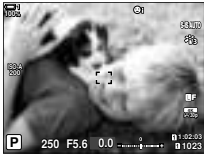
<b>Style 1</b>		
<b>Style 2</b>	Similar to film camera viewfinder displays.	
<b>Style 3</b>	The same as the monitor display.	

I tab ➔ [EVF Style] ➔ Choose an option

## **I** Viewfinder Info Display Options (Info Settings)



Choose the information that can be viewed by pressing the **INFO** button in the viewfinder display.

Just as you can with the monitor, you can display a histogram or level gauge in the viewfinder by pressing the **INFO** button. This item is used to choose the types of display available. It takes effect when [Style 1] or [Style 2] is selected for [EVF Style].

- This item is for still photography. The option selected for [Info Settings] takes effect in  mode (P. 429).
- You can choose from two custom displays containing the indicators you select and a third display showing field sensor info.

<b>Basic Information</b>	The camera displays icons and the like showing camera settings.
<b>Custom1/ Custom2</b>	In addition to the base display, you can opt to view or hide:  [  ]: A histogram superimposed on the display in the viewfinder.  [Highlight&Shadow]: Tints applied to over- and under-exposed areas.  [Level Gauge]: The level gauge.
<b>Field Sensor Info</b>	Display info from GPS and other sensors.

**I** tab → [Info Settings] → Highlight options and press the **OK** button

- Items marked with a  appear in the viewfinder display.
- To choose the custom displays available in the viewfinder, highlight [Custom1] or [Custom2] and press  on the arrow pad.

## I Viewfinder Framing Grid Options (EVF Grid Settings)

Choose whether to display a framing grid in the viewfinder. You can also choose guide color and transparency. This item takes effect when [Style 1] or [Style 2] is selected for [EVF Style].

- This item applies during both still photography and movie recording.
- The option chosen for this item is ignored when [On] is selected for Custom Menu > [Grid Settings] > [Apply Settings to EVF].

<b>Display Color</b>	Adjust guide color and transparency. The camera can store up to two combinations of settings.
<b>Displayed Grid</b>	Select the type of guides displayed. Choose from: <ul style="list-style-type: none"><li>•  ,  ,  ,  ,  , and  </li><li>• When  is selected, the guides are adjusted for a 16:9 movie frame when movies are shot in still photography mode. Depending on the option selected for   , the guides may be displayed with an aspect ratio of 17:9.</li></ul>

I tab  $\Rightarrow$  [EVF Grid Settings]  $\Rightarrow$  Choose an option  $\Rightarrow$  Choose a setting

- Use  $\Delta$   $\nabla$  on the arrow pad to choose a setting for [Display Color].
- The framing grid selected here is not displayed during focus stacking (P. 243).

4

## I Displaying the Level Gauge ( Half Way Level )

Choose whether the level gauge can be displayed in the viewfinder by pressing the shutter button halfway when [Style 1] or [Style 2] is selected for [EVF Style].



Display when shutter button is pressed halfway

<b>On</b>	The level gauge is displayed in the viewfinder while the shutter button is pressed halfway. The level gauge appears in place of the exposure bar.
<b>Off</b>	The level gauge is not displayed.

I tab  $\Rightarrow$  Half Way Level  $\Rightarrow$  Choose an option



## **I** Optical Viewfinder Simulation (S-OVF)

Increase the dynamic range of the viewfinder display, increasing the amount of detail visible in highlights and shadows in a manner similar to optical viewfinders. Backlit subjects and the like are easier to see.

- The effects of exposure, white balance, picture mode art filters, and other shooting settings cannot be previewed while optical viewfinder simulation is in effect.
- This item is for still photography. See page 89 for more information.

Off	The effects of exposure and other settings are visible in the viewfinder display. Choose to preview the effects of settings while shooting.
On	Dynamic range is increased. The effects of exposure, white balance, and other shooting settings are not visible in the display.

**I** tab ➔ [S-OVF] ➔ Choose an option



- [S-OVF] can be assigned to a control using [📷 Button Function] (P. 463). This allows optical viewfinder simulation to be turned on or off at the touch of a button.

## Other Custom Settings

### (Custom Menus **J1**, **J2**, and **J3**)

These menus contain items related to touch-screen controls, batteries, and the like. GPS-related items can also be found here, as well as an item for reducing distortion in pictures taken with fisheye lenses.

#### **J1** Image Processing Check (Pixel Mapping)

Check the image sensor and image processing functions simultaneously. For best results, end shooting and playback and wait at least a minute before proceeding.

- Be sure to perform the check again if you accidentally turn the camera off while the check is in progress.













**J1** tab ➔ [Pixel Mapping] ➔ Highlight [Start] and press the **OK** button

#### **J1** Button Hold Options (Press-and-hold Time)

Choose how long buttons must be pressed to perform resets and other similar functions for various features. For ease of use, button hold times can be set separately for different features.

- This item applies during both still photography and movie recording. See the relevant sections for more information on the features below.

#### Available Features

- End LV 
- Reset LV  Frame
- End  (movie teleconverter zoom frame display)
- Reset  Frame (movie teleconverter zoom frame position)
- Reset 
- Reset  (flash compensation)
- Reset  (highlight and shadow control)
- Reset  (color creator)
- Reset 
- Call EVF Auto Switch
- End 
- Insert Slate Tone
- End 
- Reset 
- Switch  Lock (touch controls)
- Call BKT Settings
- End Flicker Scan

**J1** tab ➔ [Press-and-hold Time] ➔ Choose an option ➔ Choose a setting

## **J1** Calibrating the Level Gauge (Level Adjust)

Correct deviation in the level gauge. Calibrate the gauge if you find it is no longer truly plumb or level.

- This item applies during both still photography and movie recording.

<b>Reset</b>	Reset the gauge to factory default settings.
<b>Adjust</b>	Choose the reference (zero) point. Calibrate the level gauge after positioning the camera appropriately.

**J1** tab ➔ [Level Adjust] ➔ Highlight an option ➔ Press **OK**

## **J1** Disabling Touch Controls (Touchscreen Settings)

Enable or disable touch controls.

- This item applies during both still photography and movie recording.

<b>Off</b>	Disable touch controls.
<b>On</b>	Enable touch controls

**J1** tab ➔ [Touchscreen Settings] ➔ Choose an option

## **J1** Storing the Cursor Position (Menu Recall)

The camera stores the current cursor position at the time you exit the menus and returns to that position when next the menus are displayed.

- This item applies during both still photography and movie recording.

<b>Recall</b>	The camera stores the cursor position. The cursor appears in the saved position the next time menus are displayed. The camera stores the position even when off.
<b>Reset</b>	The camera does not store the cursor position. The  Shooting Menu 1 tab is displayed.

**J1** tab ➔ [Menu Recall] ➔ Choose an option

4

## **J1** Reducing Fisheye Distortion (Fisheye Compensation)



Reduce distortion when shooting with fisheye lenses for results similar to those produced by extremely wide-angle lenses. You can choose from three different levels. You can also simultaneously reduce distortion when shooting under water.

- This item is for still photography. See page 250 for more information.
- This option is only available with compatible fisheye lenses.

As of January 2019, it could be used with the M.ZUIKO DIGITAL ED 8mm f1.8 Fisheye PRO.

<b>Angle</b>	After correcting distortion caused by the lens, the image is cropped to fill the frame. The picture angle of the cropped image varies with the lens. Choose from three different crops.
 <b>Correction</b>	In addition to [Angle], the camera simultaneously corrects for distortion occurring under water.

**J1** tab ➔ [Fisheye Compensation] ➔ Choose an option ➔ Highlight a setting and press the **OK** button

- When fisheye compensation is enabled, a  icon will be displayed together with the selected crop. To disable fisheye correction, open the menu and select [Off].
- [Fisheye Compensation] can be assigned to a button. It can then be turned on or off simply by pressing the button. The control can be assigned using the [ Button Function] item in  Custom Menu **B1** (P. 463).

## **J2** Battery Order and Status (Battery Settings)

View battery status and choose the order in which the batteries are used.

- This item applies during both still photography and movie recording.

<b>Battery Priority</b>	Choose the battery the camera uses first. Choose from [1] Battery] and [2] Battery].
<b>Battery Status</b>	View the status of the batteries inserted in the camera.

**J2** tab ➔ [Battery Settings] ➔ Choose an option ➔ Choose a setting

- To view battery status, highlight [Battery Status] and press **▶** on the arrow pad.

## **J2** Dimming the Backlight (Backlit LCD)

Choose the length of time before the monitor backlight dims when no operations are performed. Dimming the backlight reduces the drain on the battery.

- This item applies during both still photography and movie recording.
- Choose from [Hold], [8sec], [30sec], and [1min]. The backlight will not dim if [Hold] is selected.

**J2** tab ➔ [Backlit LCD] ➔ Choose an option

## J2 Sleep (Power Saving) Options (Sleep)

Choose the delay before the camera enters sleep mode when no operations are performed. In sleep mode, camera operations are suspended and the monitor turns off.

- This item applies during both still photography and movie recording.
- Choose from [Off], [1min], [3min], and [5min].
- The camera will not enter sleep mode if [Off] is selected.
- Normal operation can be restored by pressing the shutter button halfway or by using the buttons or multi selector.
- The camera will not enter sleep mode:
  - while a multiple exposure is in progress or while connected to an HDMI device or via Wi-Fi or USB to a smartphone or computer
- Controls that are currently locked via the lock lever cannot be used to reactivate the camera (P. 503).
- The camera may require additional time to recover from sleep mode when [On] (enabled) is selected for [Wi-Fi/Bluetooth Settings] > [Power-off Standby].  "Connecting When the Camera Is Off (Power-off Standby)" (P. 590)

J2 tab ➡ [Sleep] ➡ Choose an option

4

## J2 Auto Power Off Options (Auto Power Off)

The camera will turn off automatically if no operations are performed for a set time after it has entered sleep mode. This option is used to choose the delay before the camera turns off automatically.

- This item applies during both still photography and movie recording.
- Choose from [Off], [5min], [30min], [1h], and [4h].
- The camera will not turn off automatically if [Off] is selected.
- To reactivate the camera after it has turned off automatically, turn the camera on using the **ON/OFF** lever.

J2 tab ➡ [Auto Power Off] ➡ Choose an option

## **J2** Reducing Power Consumption (Quick Sleep Mode)

Further reduce power consumption during viewfinder photography. The delay before the backlight turns off or the camera enters sleep mode can be shortened.

- This item is for still photography.
- Power saving is not available:
  - during live view photography, while the viewfinder is on, while multiple exposure or interval timer photography is in progress, or while connected to an HDMI device or via Wi-Fi or USB to a smartphone or computer

<b>On</b>	The camera is quick to enter power-saving mode. [Backlit LCD] and [Sleep] can be set to shorter intervals than normal. <b>ECO</b> is displayed in the monitor while power-saving is in effect.
<b>Off</b>	The camera does not enter power-saving mode.

- J2** tab ➔ [Quick Sleep Mode] ➔ Highlight [On] and press **▶** on the arrow pad  
➔ Highlight an option using the **▲ ▼** buttons and press the **▶** button ➔ Use the **▲ ▼** buttons to choose a setting
- Once settings are complete, press the **OK** button repeatedly to return to **⚙** Custom Menu **J2**.

### ■ Reducing Power Consumption

- 1 Select [On] for [Quick Sleep Mode].
- 2 Select [On] for [EVF Auto Switch] (P. 553).
- 3 Enable viewfinder photography.
  - At default settings, viewfinder photography can be enabled by pressing the **[O]** (LV) button in live view.
  - A **ECO** icon will appear in the display.



### **J3** Enabling or Disabling GPS (Record GPS location)

Enable GPS. GPS co-ordinates are included in the information recorded with photos, together with data from other sensors. For more information, see “5 Using Field Sensor Data” (P. 567).

- This item is for still photography.

<b>On</b>	Enable GPS.
<b>Off</b>	Disable GPS.

**J3** tab ➔ [Record GPS location] ➔ Choose an option

- To disable GPS completely, disable all three of the following options: [Record GPS location], [Field Sensor Logger] (P. 571), and [Auto Time Adjust] (P. 455).

4

### **J3** GPS Receiver Options (GPS Priority)

Choose the GPS mode. You can prioritize accuracy over power saving or power saving over accuracy. For more information, see “5 Using Field Sensor Data” (P. 567).

<b>GPS accuracy</b>	Prioritize accuracy over power saving. Power consumption increases.
<b>Battery power</b>	Reduce power consumption. The size of the error in the location data increases slightly.

**J3** tab ➔ [GPS Priority] ➔ Choose an option



## **J3** Sensor Info Options (Elevation/Temperature)

Choose the units in which information is displayed. You can also calibrate the altitude display. For more information, see “5 Using Field Sensor Data” (P. 567).

<b>Calibrate Elevation</b>	Calibrate the altitude display. Use this option if you notice error in the altitude display.
<b>m/ft</b>	Choose the units used for altitude.
<b>°C/°F</b>	Choose the units used for temperature.

**J3** tab ➔ [Elevation/Temperature] ➔ Choose an option ➔ Choose a setting

## **J3** Log Recording (Field Sensor Logger)

Record a log and save it to a memory card. For more information, see “5 Using Field Sensor Data” (P. 567).

- Logging ends when:
  - The battery level falls below 15%
  - The camera can no longer store the log internally

<b>Start Log</b>	Start logging.
<b>Stop Log</b>	End logging. The log stored in the camera's internal memory will be saved to a memory card. If two memory cards are inserted, you can choose the card used to store the log.
<b>Save Log</b>	Copy the log data currently stored in the camera's internal memory to a memory card. If two memory cards are inserted, you can choose the card used to store the log. This option is displayed if, for example, log recording has been suspended.

**J3** tab ➔ [Field Sensor Logger] ➔ Highlight an option ➔ Press the **OK** button

### **J3** Viewing Certificates (Certification)

Display the compliance certificates for some of the standards with which the camera complies. The remaining certificates can be found on the camera itself or in the camera manual.

**J3** tab ➔ [Certification] ➔ Press the **OK** button

# 5 Using Field Sensor Data

---

Read this chapter for information on using the GPS feature and the camera's built-in sensors, including sensors for temperature and barometric pressure.

## 5-1 Notes on Field Sensors

The camera can log data on position, altitude, and heading acquired via GPS, as well as data from temperature and pressure sensors. These data can also be recorded with photographs. Logs can be viewed using the “OLYMPUS Image Track” (OI.Track) smartphone app.

For more information on OI.Track, visit:

<http://app.olympus-imaging.com/oitrack/>

- The camera also supports the Quazi-Zenith Satellite System (QZSS) and GLONASS.
- The latitude and longitude are recorded with photos shot with location data enabled.
- The camera is not equipped for navigation.
- Use the latest version of OI.Track.

### **GPS and Other Data Displays**

These displays are not intended for applications that require a high degree of precision, and the accuracy of the data (latitude and longitude, heading, altitude, temperature, and the like) they provide is not guaranteed. The accuracy of these displays may be also affected by factors not under the control of the manufacturer.

## GPS: Precautions for Use

Disable wireless LAN, **Bluetooth**<sup>®</sup>, and GPS in countries, regions, or locations in which their use is prohibited.

5

The camera is equipped with wireless LAN, **Bluetooth**<sup>®</sup>, and GPS. Use of these features in countries outside the region of purchase may violate local wireless regulations.

Further, some countries and regions may prohibit the acquisition of location data without prior governmental permission. In some Olympus sales areas, the camera may consequently ship with location data displays disabled.

Each country and region has laws and regulations you must obey when using the camera abroad. Check the regulations for your destination before traveling. Olympus assumes no liability for failure to observe local laws and regulations.

Disable Wi-Fi and GPS on airplanes and in other locations where their use is prohibited.  “5-3 Disabling GPS” (P. 580), “Ending the Connection” (P. 598)

Depending on the status of the camera and communication, it may take time to acquire the position information. When the A-GPS is used, the position determination time can be shortened from a few seconds to a few tens of seconds. The A-GPS data can be updated using the smartphone app “OLYMPUS Image Track” (OI.Track) or the PC software “OLYMPUS A-GPS Utility”.

Make sure that the camera date is set correctly.

- A-GPS data must be updated every 4 weeks. The position information may have changed when time has elapsed after updating the data. Use as new A-GPS data as possible.
- The provision of A-GPS data may be terminated without prior notice.

### Updating the A-GPS Data Using a Smartphone

Before update, install the smartphone app “OLYMPUS Image Track” (OI.Track) on your smartphone. Refer to the URL below for details on how to update the A-GPS data.

<http://app.olympus-imaging.com/oitrack/>

Adjust Wi-Fi settings on the camera and establish a connection to the smartphone before proceeding (P. 584). Select [Update GPS Assist Data] in the OI.Track settings dialog.

- If a connection error is displayed, you will need to re-establish the connection between the camera and smartphone

### Updating the A-GPS Data Using a PC

Download the OLYMPUS A-GPS Utility software from the URL below, and install it on your PC.

<http://sdl.olympus-imaging.com/agps/>

Refer to “OLYMPUS A-GPS Utility Instruction Manual” on the website with above URL for details on how to update the data.

- If you are using the GPS function for the first time and the A-GPS has not been updated, or if the function has not been used for a long time, it may take a few minutes for the position measurement to end.





## 5-2 Using Field Sensors

### Recording Location Data (Record GPS location)



With the exception of location data, data provided by camera sensors are recorded with every picture. GPS must be enabled before location data will be recorded.

- Pictures with location data are indicated by a  icon during playback.





- 1 Press the **MENU** button to display the menus.
- 2 Highlight [Record GPS location] in  Custom Menu  (  Utility) and press  on the arrow pad.



- 3 Highlight an option using the   buttons and press the **OK** button.





- 4 Press the **MENU** button repeatedly to exit the menus.
  - A  icon is displayed when [On] is selected for [Record GPS location].
  - The  icon will flash while the camera calculates its position, stopping when the process is complete.



- Location data will not be recorded with pictures taken while the camera is calculating its position.

## Field Sensor Logs

The camera records sensor and GPS data at regular intervals to create a log. Logs can be viewed using the “OLYMPUS Image Track” (OI.Track) smartphone app. You can see the route you traveled with your camera and the locations where pictures were taken.

Use [Field Sensor Logger] in  Custom Menu  to start logging sensor data. Location data will be recorded if they can be acquired via GPS.

### Logging Data (Field Sensor Logger)

When logging starts, the camera records the data internally. The data are saved to a memory card when logging ends. Logging will continue even while the camera is off. Logging is available only if the camera clock is set.  [Settings] (P. 455)

- Logging ends if:
  - The battery level falls below 15%
  - The camera can no longer record the log data internally

The following options are available:

<b>Start Log</b>	Start logging.
<b>Stop Log</b>	End logging. The data recorded internally will be transferred to a memory card. If two cards are inserted, you will be prompted to choose the card used to store the log.
<b>Save Log</b>	Copy the current log from internal memory to a memory card. If two cards are inserted, you will be prompted to choose the card used to store the log. Saving the log may take a few minutes.

- Logging cannot start or end while the camera is connected to a smartphone.
- A message will be displayed while the log is transferred to the memory card. Do not remove the card while the message is displayed. Failure to observe this precaution could result in the log being lost or in damage to the camera or card.
- Logs cannot be saved if the memory card is full or otherwise unusable. Delete unwanted data or take such other steps as may be needed to save the log.
- Each memory card can store a maximum of 199 log files. A warning will be displayed as this limit approaches (P. 637). Insert another memory card or delete log files after copying them to a computer.
- Selecting [Full] for [Reset / Custom Modes] (P. 91) > [Reset] in  Shooting Menu 1 does not affect the option selected for [Field Sensor Logger]. The log currently stored in the camera's memory is not deleted and logging continues without interruption.
- The current log may be deleted from the camera's internal memory during firmware updates. Be sure to save the log to a memory card before updating camera firmware.
- While the camera is off, the power needed to log data is drawn from whichever battery currently has the greatest charge, regardless of the chosen battery order.

- 1 Press the **MENU** button to display the menus.
- 2 Highlight [Field Sensor Logger] in **Custom Menu** **J3** (📷 Utility) and press **▷** on the arrow pad.

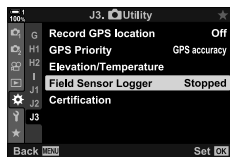

- 3 Press the **OK** button when [Start Log] is displayed.
  - The item displayed varies with log status. See “Menu Items”, below.



- 4 Press the **MENU** button repeatedly to exit the menus.
  - A **LOG** icon will appear when sensor data are viewed in the information display (P. 429, 515).



**LOG** icon

## Menu Items



The content of the [Field Sensor Logger] menu varies with the camera's operational status.

Camera status	Item displayed
<b>Logging off</b>	[Start Log]: Start a new log.
<b>Logging in progress</b>	[Stop Log]: End the current log and save it to the memory card.
<b>⚠ Paused</b>	[Save Log]: Save the current log to the memory card.



## Warnings

The following table describes the steps to be taken when a warning is displayed.

Warning	Problem	Solution
 (flashes red)	The number of log files stored on the current card is approaching the maximum.	Delete unwanted files after copying the logs to a computer.
	Log files cannot be saved to the current card.	Insert a write-enabled card.
	Logging paused, either because the batteries are low or the built-in memory the camera uses to store the current log file is full.	Save the current log to a memory card.

GPS and other sensor data can be viewed in an electronic compass display.

Sensor data can be added to the displays available during live view photography. An electronic compass display is available during viewfinder photography and on other occasions when live view is not available.

### Sensor Data (Live View)



- ① Receiving GPS data  
Steady: Position acquired  
Flashing: Calculating position
- ② Field sensor log status  
LOG (green): Log in progress  
LOG (red): Log in progress (no memory card available to store current log or maximum log file count approaching)  
LOG: Logging suspended or unsaved log remaining in memory

• Camera orientation is shown as follows:



Lens direction

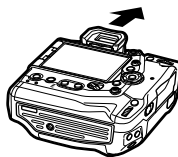

Orientation of camera top

### Electronic Compass (Viewfinder Photography)

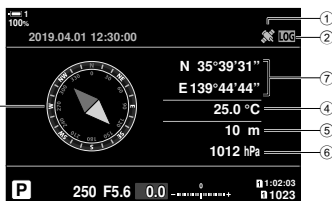

- ③ Heading
- ④ Temperature
- ⑤ Altitude
- ⑥ Barometric pressure
- ⑦ Location data (longitude/latitude)

- Location data are only shown in the sensor data display when GPS is enabled. GPS can be enabled using any of the following items:
  - [Record GPS location] in **Custom Menu D3** (P. 570)
  - [Field Sensor Logger] in **Custom Menu D3** (P. 571)
  - [Auto Time Adjust] in the **Y** setup menu (P. 455)

## Enabling Sensor Data Display

### ■ Still Photography Modes (Info/Info Settings)

- 1 Press the **MENU** button to display the menus.
- 2 Highlight [Info/Info Settings] in **Custom Menu D1** (Disp/Info)/PC) and press **▶** on the arrow pad.

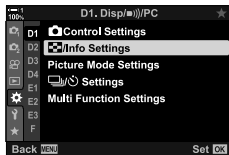

- 3 Highlight options using the **Δ** **▽** buttons and press the **▶** button.

- **To enable the live view sensor data display:** Select [LV-Info], then highlight [Field Sensor Info] and press the **OK** button. The selected item will be marked with a check (✓).
- **To enable the electronic compass display:** Select [LV OFF-Info], then highlight [Field Sensor Info] and press the **OK** button. The selected item will be marked with a check (✓).

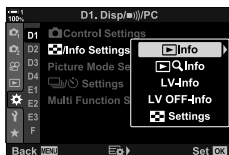

- 4 Press the **MENU** button when settings are complete.
  - **Custom Menu D1** will be displayed.
- 5 Press the **MENU** button repeatedly to exit the menus.
  - You can also exit the menus by pressing the shutter button halfway.

## 6 Display sensor data or the electronic compass.

- Sensor data appear in the live view display. Press the **INFO** button repeatedly until sensor data are displayed.

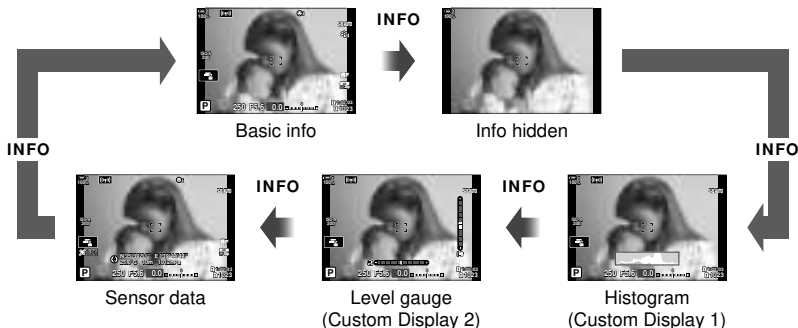

- You can also hold the **INFO** button and rotate the front or rear dial to choose the information displayed. The displays can be cycled in either direction.
- The electronic compass is displayed when the monitor is not being used for live view. Press the **INFO** button to toggle the information displayed.

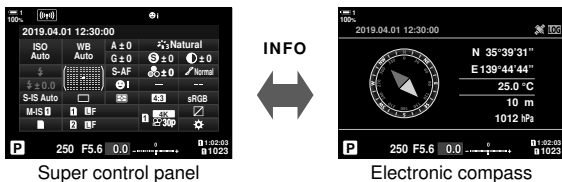

- To view sensor info in the viewfinder when [Style 1] or [Style 2] is selected for [EVF Style], select [Field Sensor Info] for [Info Settings] in **Custom Menu 1** (P. 555).

## ■ Movie Mode (📽️ Info Settings)

- 1 Press the **MENU** button to display the menus.
- 2 Highlight [📽️ Display Settings] in the 📽️ video menu and press **▶** on the arrow pad.
- 3 Highlight [📽️ Info Settings] using the **△ ▽** buttons and press the **▶** button.
  - [Field Sensor Info] will be marked with a check (✔).
- 4 Highlight [Field Sensor Info] using the **△ ▽** buttons and press the **OK** button.

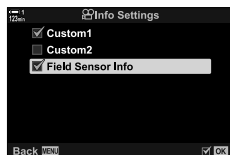
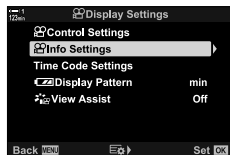

- 5 Press the **MENU** button repeatedly to exit the menus.
- 6 Press the **INFO** button repeatedly to view sensor data in the shooting display.

# Sensor Data Display Options (Elevation/Temperature)

Choose the units used for temperature and altitude in the sensor data display. You can also calibrate altitude.

<b>Calibrate Elevation</b>	Calibrate altitude when the current altitude and the value shown by the camera do not match.
<b>m/ft</b>	Choose whether altitude is shown in meters (m) or feet (ft).
<b>°C/°F</b>	Choose whether the temperature is displayed in degrees Celsius (°C) or degrees Fahrenheit (°F).

- 1 Press the **MENU** button to display the menus.
- 2 Highlight [Elevation/Temperature] in **Custom Menu** **J3** (Utility) and press **▶** on the arrow pad.

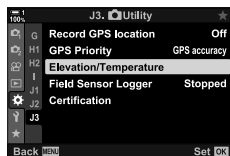

- 3 Highlight an item using the **▲▼** buttons and press the **▶** button.
  - Options for the selected item will be displayed.

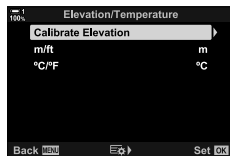

- 4 Highlight an option using the **▲▼** buttons and press the **OK** button.
  - **Custom Menu J3** will be displayed.
- 5 Press the **MENU** button repeatedly to exit the menus.

Choose the GPS mode.

<b>GPS accuracy</b>	Prioritize accuracy over power saving. Power consumption increases.
<b>Battery power</b>	Prioritize power saving over accuracy. The size of the error in the location data increases slightly.

- 1 Press the **MENU** button to display the menus.
- 2 Highlight [GPS Priority] in **Custom Menu J3** (📷 Utility) and press **▶** on the arrow pad.



- 3 Highlight an option using the **Δ** **∇** buttons and press the **OK** button.
  - **Custom Menu J3** will be displayed.

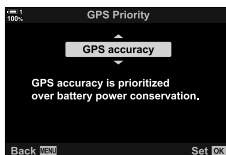

- 4 Press the **MENU** button repeatedly to exit the menus.

## 5-3 Disabling GPS

The use of GPS or Wi-Fi may be prohibited in some countries, regions, or locations. To disable GPS, disable all the following settings as described below.

- ⚙ Custom Menu **B** > [Record GPS location] (P. 570)
  - ➔ Select [Off]
- ⚙ Custom Menu **B** > [Field Sensor Logger] (P. 571)
  - ➔ Confirm that [Stop Log] is selected
- ⚙ setup menu > [⌚ Settings] (P. 455) > [Auto Time Adjust]
  - ➔ Select [Off]

### ■ Menu Access

- 1** **B** (📷 Utility) tab ➔ [Record GPS location] (P. 570) ➔ [Off]
- 2** **B** (📷 Utility) tab ➔ [Field Sensor Logger] (P. 571) ➔ Confirm that [Stop Log] is selected
- 3** ⚙ (setup menu) tab ➔ [⌚ Settings] (P. 455) ➔ [Auto Time Adjust] ➔ [Off]



# 6

## Connecting the Camera to External Devices

---

Connect the camera to external devices such as computers or displays using cables or via wireless LAN.

## 6-1 Connection Types and Software

A number of tasks can be accomplished by connecting the camera to an external device such as a computer or smartphone. Choose a connection type and software according to your goals.

### **Connecting to Smartphones via Wi-Fi**

With a direct Wi-Fi link to the camera, smartphones can be used to view the pictures on the camera and take pictures remotely. With a **Bluetooth®** or Wi-Fi connection, you can view and download pictures using smartphone controls without even turning the camera on.

Connect using the “OLYMPUS Image Share” (OI.Share) app.

### **Connecting to Computers via Wi-Fi**

Pictures can be automatically uploaded to a computer connected via a router or access point. You can take pictures using the camera and view them on the computer.

Connect using “OLYMPUS Capture” computer software.

### **Connecting to Computers via USB**

Connect the camera via USB to control it remotely and take pictures from a computer. You also have the option of uploading pictures to the computer automatically. Computers can be used to both take and view pictures at the same time.

Connect using “OLYMPUS Capture” computer software.

Photos and movies that have been uploaded to the computer can be edited or organized using “Olympus Workspace”.

### **Connecting to External Displays**

Pictures can be displayed on televisions connected to the camera via HDMI. Use the television to display pictures to an audience. When connected to a television, the camera can be controlled using the TV remote. No app or other software is required.

You can also connect the camera to HDMI monitors or video recorders. For more information, see page 434.

## Precautions for Using Wi-Fi and Bluetooth®

Disable wireless LAN, **Bluetooth®**, and GPS in countries, regions, or locations in which their use is prohibited.

The camera is equipped with wireless LAN, **Bluetooth®**, and GPS. Use of these features in countries outside the region of purchase may violate local wireless regulations.

Some countries and regions may prohibit the acquisition of location data without prior governmental permission. In some Olympus sales areas, the camera may consequently ship with location data displays disabled.

Each country and region has its own laws and regulations. Check them before traveling and observe them while abroad. Olympus assumes no liability for any failure on the part of the user to observe local laws and regulations.

Disable Wi-Fi and GPS on airplanes and in other locations where their use is prohibited.  “5-3 Disabling GPS” (P. 580), “Ending the Connection” (P. 598)

- Wireless transmissions are vulnerable to interception by third parties. Use wireless features with this in mind.
- The wireless transceiver is located in the camera grip. Keep it as far away as practicable from metal objects.
- When transporting the camera in a bag or other container, be aware that the contents of the container or the materials of which it is constructed may interfere with wireless transmissions, which can prevent the camera connecting to a smartphone.
- Wi-Fi connections increase the drain on the batteries. The connection may be lost during use if the batteries are low.
- Devices such as microwave ovens and cordless phones that generate radio-frequency emissions, magnetic fields, or static electricity may slow or otherwise interfere with wireless data transmission.
- Some wireless LAN features are unavailable when the memory card write-protect switch is in the “LOCK” position.

## 6-2 Connecting to Smartphones via Wi-Fi

Connect the camera and smartphone using a direct Wi-Fi link.

Use the “OLYMPUS Image Share” (OI.Share) smartphone app to connect to the camera from a smartphone.

Once installed on your smartphone, OI.Share can be used to view the scene visible through the camera lens and take pictures remotely.

OI.Share can also be used to view and download the photos and movies on the camera memory card. Using **Bluetooth**® and Wi-Fi, you can operate the camera using smartphone controls alone. You can also download previously-selected pictures to the smartphone while the camera is off.

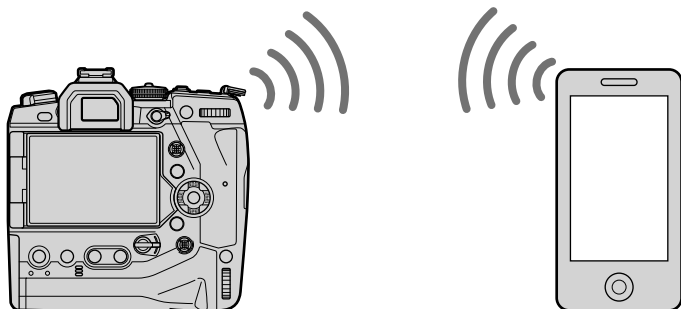

## Installing Apps

To connect to the camera from your smartphone via Wi-Fi, use “OLYMPUS Image Share” (OI.Share).

### **OLYMPUS Image Share**

Use the smartphone to control the camera remotely and download pictures. For more information, visit:

<http://app.olympus-imaging.com/oishare/>

In addition to OI.Share, Olympus offers the following apps for viewing sensor logs and retouching pictures:

- **OLYMPUS Image Track**

Use “OLYMPUS Image Track” (OI.Track) to view and manage field sensor logs recorded with the camera. For more information, visit:

<http://app.olympus-imaging.com/oitrack/>

- **OLYMPUS Image Palette**

Use “OLYMPUS Image Palette” (OI.Palette) to retouch pictures downloaded to the smartphone. Supported are such features as art filters, the Color Creator, and cropping pictures. For more information, visit:







<http://app.olympus-imaging.com/oipalette/>

# Connecting to Smartphones (Wi-Fi/Bluetooth Settings)

Adjust camera settings for connection to a smartphone. OI.Share is required. Changes made using OI.Share apply to both Wi-Fi and **Bluetooth**®. Install the app on the smartphone before proceeding.

## Readying the Camera (Availability)

Enable Wi-Fi and **Bluetooth**® on the camera. Note that this is not necessary at default settings, as Wi-Fi is enabled by default. The camera displays a  icon when Wi-Fi is enabled.

- 1 Press the **MENU** button to display the menus.
- 2 Highlight [Wi-Fi/Bluetooth Settings] in the  setup menu and press  on the arrow pad.
- 3 Highlight [Availability] using the   buttons and press the  button.
- 4 Highlight [On] using the   buttons and press the **OK** button.
  - [Wi-Fi/Bluetooth Settings] options will be displayed.

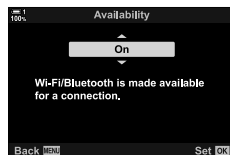
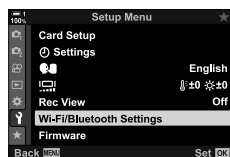

- 5 Press the **MENU** button repeatedly to exit the menus.
  - A  icon will be displayed.



## Pairing the Camera and Smartphone

Follow the steps below when connecting the devices for the first time.

- Adjust pairing settings using OI.Share, not the settings app that is part of the smartphone operating system.

- 1 Launch the copy of the dedicated OI.Share app previously installed on your smartphone.



- 2 Press the **MENU** button on the camera to display the camera menus.

- 3 Highlight [(Wi-Fi)] Wi-Fi Connect in the [▶] playback menu and press [▶] on the arrow pad.

- [(Wi-Fi)] Wi-Fi Connect options will be displayed.
- This item is only available when [On] is selected for [Wi-Fi/Bluetooth Settings] > [Availability] in the camera [⌵] setup menu.

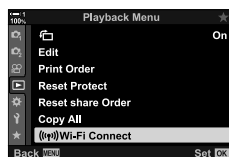

- 4 Highlight [Device Connection] using the [Δ] [▽] buttons and press the **OK** button.
  - A pairing guide will be displayed in the camera monitor.



- 5 Press the **OK** button after reading each page of instructions.
  - Stop when you reach the following display.

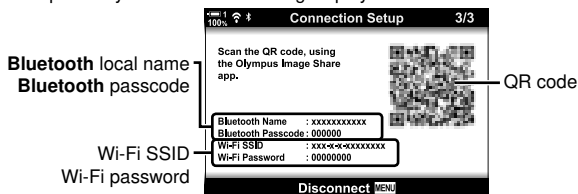

- The display lists the **Bluetooth** local name and passcode, the Wi-Fi SSID and password, and a QR code.

6

**6** Tap the camera icon at the bottom of the OI.Share display.

- An [Easy Setup] tab will be displayed.



**7** Following the instructions displayed by OI.Share, scan the QR code to proceed with pairing.

- OI.Share will display a message when settings are complete.
- Smartphones that are unable to scan QR codes must be configured manually. Tap [Can't scan the QR code?] in the OI.Share QR scan display and follow the on-screen instructions.
- If the smartphone is currently connected via Wi-Fi to another network or device, you will need to select the camera in the Wi-Fi connection section of the smartphone settings app.
-  will be displayed when pairing is complete.

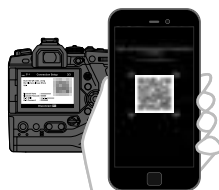

**8** Once the devices are paired, tap [Import Photos] in the smartphone OI.Share display to view the pictures on the camera memory card.

- To end the connection, press the camera **MENU** button or tap [Disconnect] in the monitor.
- You can also end the connection by turning the camera off from inside the OI.Share display.





- You can change the connection password generated by the camera (P. 618).
- If the smartphone is unable to read the QR code, you will need to configure the device manually following the instructions displayed by OI.Share.

**Bluetooth®:** In the OI.Share **Bluetooth®** settings dialog, select the local name displayed in the camera monitor and enter the passcode.

**Wi-Fi:** Display Wi-Fi settings in the smartphone settings app and enter the SSID and password displayed by the camera. For information on the settings app, see the documentation for your smartphone.

# Connecting When the Camera Is Off (Power-off Standby)

The camera can be configured not to end the connection to the smartphone when turned off. The smartphone can then access the camera and automatically download pictures while the camera is off.

- Before proceeding, confirm that:
  - [On] is selected for [Wi-Fi/Bluetooth Settings] > [Availability] (P. 586),
  - the camera and smartphone are paired (P. 587), and
  - a memory card is inserted
- The camera performs network-related processing while powering down with [On] (enabled) selected for [Power-off Standby]. It may therefore require additional time to power on immediately after having been turned off.

<b>Select</b>	When turning the camera off via the <b>ON/OFF</b> lever, you will be prompted to choose whether the wireless connection to the smartphone remains active while the camera is off.
<b>Off</b>	Turning the camera off ends the wireless connection to the smartphone.
<b>On</b>	The wireless connection to the smartphone remains active after the camera is turned off. The smartphone can be used to download pictures from the camera or view the pictures on the camera memory card.

- 1 Press the **MENU** button to display the menus.
- 2 Highlight [Wi-Fi/Bluetooth Settings] in the **↓** setup menu and press **▷** on the arrow pad.
- 3 Highlight [Power-off Standby] using the **△** **▽** buttons and press the **▷** button.

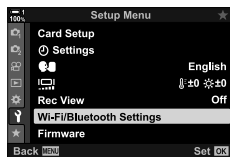

- 4 Highlight an option using the **△** **▽** buttons and press the **OK** button.

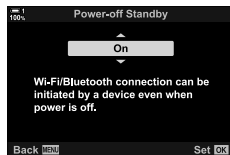

- 5 Press the **MENU** button repeatedly to exit the menus.

## [Select]

If you select [Select] for [Power-off Standby], a confirmation dialog will be displayed the next time the camera is turned off. Highlight an option using  $\Delta$   $\nabla$  on the arrow pad and press the **OK** button.

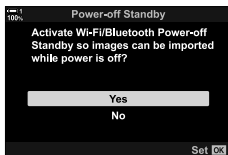

<b>Yes</b>	The camera will turn off, leaving the wireless connection to the smartphone active.
<b>No</b>	The camera will end the connection to the smartphone before turning off.

- If no operations are performed about a minute after the confirmation dialog is displayed, the camera will end the wireless connection to the smartphone and turn off automatically.
- The connection will end automatically under the conditions listed below. The connection will be re-enabled when next you turn the camera on.
  - 24 hours pass with no data being exchanged with the smartphone.
  - The memory card is removed and reinserted.
  - The batteries are replaced.

## Copying Pictures to Smartphones

Pictures on the camera memory card can be downloaded to a smartphone using either of the following methods:

- Use the smartphone to select pictures for download.
- Automatically download previously-selected pictures while the camera is off.

These methods are described below.

### Downloading Pictures Selected with OI.Share

Use the smartphone to view the pictures on the camera and select pictures for download.

- 1 Launch the dedicated OI.Share app on the smartphone.
- 2 Start the connection using camera menus or touch controls.

- **To start the connection from the menus:** Highlight **[Wi-Fi Connect]** in the **[Playback Menu]** and press **[OK]** on the arrow pad. Highlight **[Device Connection]** and press the **OK** button. **Wi-Fi** will be displayed when a connection is established.



- **To start the connection using touch controls:** Tap **[Wi-Fi]** in the camera monitor and tap **[Device Connection]** when prompted. **Wi-Fi** will be displayed when a connection is established.

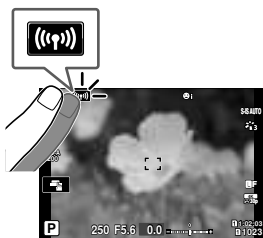

- If you have previously connected to the smartphone, the camera will start the connection automatically.

- 3** Tap [Import Photos] in OI.Share.
- OI.Share will list the images on the camera.
  - The memory card can be selected using OI.Share.



- 4** Select pictures and tap the save button.
- Once download is complete, you can turn the camera off from OI.Share.





- If the following options are selected for [Wi-Fi/Bluetooth Settings] in the  $\Upsilon$  (setup) menu, you will also be able to download pictures to the smartphone as described in Steps 3 and 4 while the camera is off.
  - [Availability]: [On]
  - [Power-off Standby]: [On]

## Auto Download

Pictures previously marked for sharing on the camera can be downloaded automatically when the camera is off.

### 1 Mark pictures for sharing.

- Display pictures and mark them for sharing. See “Selecting Pictures for Sharing (Share Order)” (P. 277) and “Selecting Movies for Sharing (Share Order)” (P. 446) for more information.
- Press the  (share) button to mark pictures for sharing during playback. Pictures that have been selected for sharing are indicated by a  icon.
- You can also press the **OK** button and select the desired option from a menu.

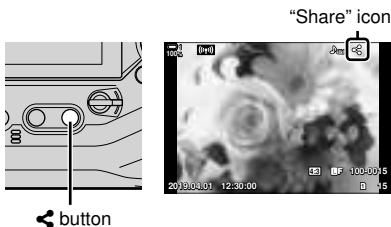

### 2 Choose the operation performed when the camera is off.

- Choose an option for [Power-off Standby]. See page 590 for details.  
**MENU** button  $\Rightarrow$   $\uparrow$  (setup menu)  $\Rightarrow$  [Wi-Fi/Bluetooth Settings]  $\Rightarrow$  [Power-off Standby]  $\Rightarrow$  Highlight [On] or [Select] and press the **OK** button

### 3 Turn the camera off.

- The selected photos and movies will be uploaded to the smartphone automatically. If you are using an iOS device, launch OI.Share on the smartphone before turning the camera off.
- If [Select] is chosen for [Power-off Standby], a confirmation dialog will be displayed (P. 591). Highlight [Yes] and press the **OK** button.
- Up to 200 pictures on each slot can be marked for sharing at a time.
- iOS devices will not connect to the camera automatically via a router or other wireless access point. Use OI.Share to download pictures.
- Some smartphones may end download on entering sleep mode. Configure the smartphone to not enter sleep mode.





## Removing Share Marking (Reset Share Order)

Remove share marking from all the pictures on the card in a selected slot. Share marking can be removed from multiple pictures in one operation. See “Selecting Pictures for Sharing (Share Order)” (P. 277) and “Selecting Movies for Sharing (Share Order)” (P. 446).

- **MENU** button ➔  (playback menu) tab ➔ [Reset share Order] ➔ Highlight [Yes] and press the **OK** button

## Remote Photography Using a Smartphone

Use OI.Share to control the camera remotely and take pictures from a smartphone.



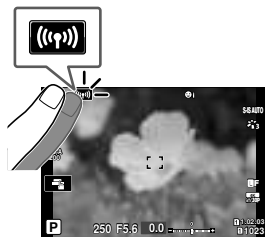

- 1 Launch the dedicated OI.Share app on the smartphone.
- 2 Tap  in the camera monitor and tap [Device Connection] when prompted.
  - If connection options are displayed, highlight [Device Connection] and press the **OK** button.
  - If you have previously connected to the smartphone, the camera will start the connection automatically.
  - To connect from the camera menus, highlight  Wi-Fi Connect] in the  playback menu and press  on the arrow pad. Highlight [Device Connection] and press the **OK** button.
  -  1 will be displayed when a connection is established.
- 3 Tap [Remote Control] in OI.Share.
  - Remote control options will be displayed.
- 4 Tap the shutter button to take pictures.
  - The pictures will be saved to the memory card.





## Accessing Field Sensor Logs

Use OI.Share to view sensor logs created with the camera.  [Field Sensor Logger] (P. 565)

- 1 Launch the dedicated OI.Share app on the smartphone.
- 2 Tap  in the camera monitor and tap [Device Connection] when prompted.
  - If the camera prompts you to choose a connection, highlight [Device Connection] and press the **OK** button.
  - If you have previously connected to the smartphone, the camera will start the connection automatically.
  - To connect from the camera menus, highlight  Wi-Fi Connect] in the  playback menu and press  on the arrow pad. Highlight [Device Connection] and press the **OK** button.
  -  1 will be displayed when a connection is established.
- 3 Tap [Add Geotag] in OI.Share.
  - OI.Track will start.
  - If OI.Track is not installed, install it as directed in the on-screen instructions.
- 4 Tap [Add Logs from Camera] in OI.Track.
  - OI.Track will list the logs recorded by the camera. Tap a log to display it.

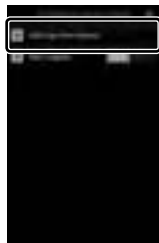
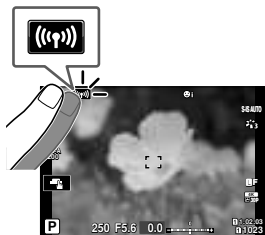

## Ending the Connection

End the connection to the smartphone. The camera uses Wi-Fi and **Bluetooth®** when connecting to smartphones. The use of these features may be prohibited in some countries or regions, in which case they should be disabled.

### Ending the Current Connection

- 1 Use the [Power Off] slider in the OI.Share or OI.Track settings dialog.
  - Alternatively, you can press the camera **MENU** button and tap [Disconnect] in the monitor.

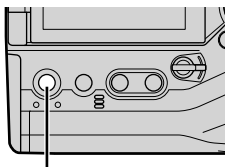

MENU button



Disconnect



- 2 Select [Off] for [Power-off Standby] to disable the “auto upload while off” feature.
  - **MENU** button ➔ **⌵** setup menu ➔ [Wi-Fi/Bluetooth Settings] ➔ [Power-off Standby] ➔ [Off]

### Disabling Wi-Fi/Bluetooth®

- 1 Press the **MENU** button to display the menus.
- 2 Highlight [Wi-Fi/Bluetooth Settings] in the **⌵** setup menu and press **▶** on the arrow pad.

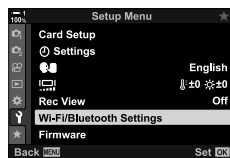

- 3 Highlight [Availability] using the **Δ**/**∇** buttons and press the **▶** button.



- 4 Highlight [Off] using the  $\Delta$   $\nabla$  buttons and press the **OK** button.

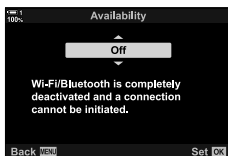

## 6-3 Connecting to Computers via Wi-Fi

Connect the camera and computer via Wi-Fi. Using Wi-Fi, the camera can connect via a router to a computer on a household network or the like.

Use “OLYMPUS Capture” computer software to connect to the camera from a computer. Pictures taken with the camera are uploaded automatically to the computer, where you can view the results while shooting is in progress.

Using this feature requires that you install the software on the computer, pair the computer with the camera, and adjust camera settings for connection via the router or access point.

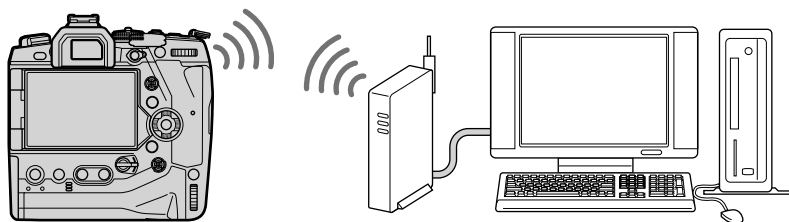

## Installing Software

Use “OLYMPUS Capture” to connect the camera and computer via Wi-Fi.

### **OLYMPUS Capture**

Use “OLYMPUS Capture” to automatically download and view pictures taken with a camera connected via Wi-Fi to the same network as the computer. To learn more or to download the software, visit the website below. When downloading the software, be prepared to provide the camera serial number.

<http://app.olympus-imaging.com/olympuscapture/>

Follow the on-screen instructions to install the software. System requirements and installation instructions are available at the website above.

## Readying the Computer (Windows)

If Windows is unable to detect a camera connected via a router or access point, follow the steps below to register the device manually.

### ■ Windows 8/Windows 10

- 1 Connect the camera and computer using a USB cable.
- 2 Click  on the computer desktop to display [Windows Settings] options.
- 3 Click [Devices] to display options for [Bluetooth & other devices].



- 4 Click [Add Bluetooth or other devices].
- 5 Click [+ Everything else].
  - An [Add a device] window will open and [E-M1X] will be displayed after a short pause.
- 6 Click [E-M1X].
  - When a message is displayed stating the preparation is complete, click [Done].

### ■ Windows 7

- 1 Connect the camera and computer using a USB cable.
  - [E-M1X] will be displayed in Windows Explorer.
- 2 Right-click [E-M1X] and select [Install].
  - A message will be displayed when device registration is complete.
  - Check that the device is registered in the Device Manager.



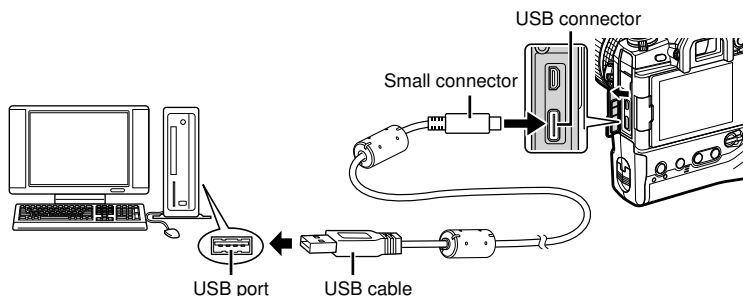

## Pairing the Computer with the Camera (New Link)

The camera and computer must be paired in order to connect. Up to four computers can be paired with the camera at a time. To pair a computer with the camera, connect it via USB. Pairing need only be performed once per computer.

- 1 After confirming that the camera is off, connect it to the computer using the USB cable.
  - Use the supplied cable protector and cable clip to prevent damage to the connectors when the USB cable is connected.  “Attaching Cable Protectors” (P. 29)



- The locations of USB ports vary from computer to computer. See the documentation provided with the computer for information on USB ports.

- 2 Turn the camera on.
  - The camera will display a message prompting you to identify the device to which the USB cable is connected.
  - If the message is not displayed, select [Auto] for [USB Mode] (P. 529) in  Custom Menu .
  - If the batteries are very low, the camera will not display a message when connecting to a computer. Be sure the batteries are charged.
- 3 Highlight  using   on the arrow pad and press the **OK** button.

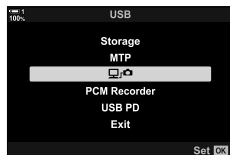

**4** Launch the copy of “OLYMPUS Capture” installed on the computer.

- After starting up, “OLYMPUS Capture” will prompt you to choose the connection type.



**5** Click [Create new link].

- If nothing happens, reconnect the camera.



[Create new link]

- Enter the name that will be used on the camera to identify the computer. The default is the computer's "Computer Name".
- The name used on the camera can be up to 15 characters long.

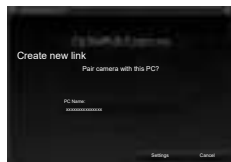

**6** Click [Settings] in “OLYMPUS Capture”.

- When a message is displayed stating that pairing is complete, disconnect the camera as instructed.



[Settings]



- Repeat the above steps to pair the camera with each additional computer.
- The pairing information stored on the camera can be viewed and deleted using “OLYMPUS Capture”.



Adjust settings for connection to the network to which the paired computer belongs.

Before the camera can connect to the computer via Wi-Fi, it must be configured for connection to the network via the Wi-Fi router or access point. Multiple network profiles can be stored on the camera and recalled as desired. (((Wi-Fi))) Wi-Fi Connect settings can be adjusted via the following methods:

<b>Connect by WPS</b>	<p>Configure the camera for automatic connection (P. 607). To connect using a WPS router or access point, simply press the device's WPS button.</p> <p>[PBC Method]: Connect using only the router WPS button. The camera connects automatically when the button is pressed.</p> <p>[PIN Method]: The camera connects in PIN mode. Enter the camera PIN on the router to connect.</p>
<b>Connect from Access Point List</b>	<p>Choose the network from a list (P. 612). The camera will search for available networks; to connect, select a network from the list and enter the network password.</p>
<b>Connect manually</b>	<p>Adjust connection settings manually (P. 609). To connect, enter the network name (SSID) and other settings.</p>

- WPS connections require a WPS-compatible router or access point.
- Connecting via WPS in PIN mode requires that the router itself be connected to a administrator computer from which the PIN can be entered.
- Manual connection requires that you have information on the network to which you are connecting.
- The camera can connect via routers or access points of the following types:
  - Standard: IEEE802.11a/b/g/n/ac
  - Band: 2.4 GHz or 5 GHz
  - Security: WPA2
- The camera can store settings for up to eight networks. The camera will automatically connect to networks to which it has previously connected.
- Each new connection after the eighth overwrites settings for the connection that has been left unused for the longest period of time.
- Adding a network profile for an access point with the same MAC address as existing profile overwrites the settings for the existing profile.
- For information on using routers or access points, see the documentation provided with the device.
- Network profiles are not reset when you select [Full] for [Reset / Custom Modes] (P. 91) > [Reset] in  Shooting Menu 1. To reset network settings, use [Wi-Fi/Bluetooth Settings] (P. 457) > [Reset Settings] in the  setup menu.

## Enabling Camera Wi-Fi (Wi-Fi/Bluetooth Settings)

Before connecting to a network via Wi-Fi, you will need to enable Wi-Fi on the camera. Note that this is not necessary at default settings, as Wi-Fi is enabled by default. Proceed to page 607.

- 1 Press the **MENU** button to display the menus.
- 2 Highlight [Wi-Fi/Bluetooth Settings] in the **↓** setup menu and press **▶** on the arrow pad.

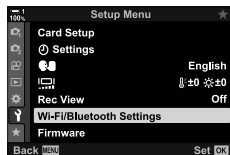

- 3 Highlight [Availability] using the **△** **▽** buttons and press the **▶** button.



- 4 Highlight [On] using the **△** **▽** buttons and press the **OK** button.
  - [Wi-Fi/Bluetooth Settings] options will be displayed.



- 5 Press the **MENU** button repeatedly to exit the menus.

## Connecting via WPS (Connect by WPS)

Connect using the WPS feature on the router or access point.

- 1 Press the **MENU** button on the camera to display the camera menus.
- 2 Highlight [(Wi-Fi)] Wi-Fi Connect] in the [▶] playback menu and press [▶] on the arrow pad.
  - [(Wi-Fi)] Wi-Fi Connect] options will be displayed.
  - This item is only available when [On] is selected for [Wi-Fi/Bluetooth Settings] > [Availability] in the camera [↵] setup menu.
- 3 Highlight [Access Point Connection] using the [Δ] [▽] buttons and press the **OK** button.
  - [Access Point Connection] options will be displayed.
- 4 Highlight [Connect by WPS] using the [Δ] [▽] buttons and press the **OK** button.
- 5 Highlight an option using the [Δ] [▽] buttons and press the **OK** button.
  - If you selected [PBC Method], press the WPS button on the router or access point.
  - Press the camera **OK** button to start the connection.
  - Some time may be required for connection after the button is pressed.
  - If you selected [PIN Method], the camera will display a PIN; enter it on the router or access point. Press the camera **OK** button when the router is ready to connect.

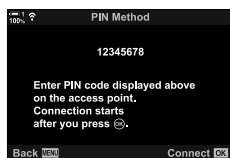

**6** If the camera is able to connect, the network will be displayed with a check (✓) next to the network name.

- If the camera has been paired with more than one computer, you will be prompted to choose a computer before the network is displayed. Highlight the desired computer using the  $\Delta$   $\nabla$  buttons and press the **OK** button.
- The camera can be used only with the selected computer. To select a different computer, you must first terminate the current connection.
- If the connection fails, the camera will display a message to that effect, followed by the options shown in Step 5. Repeat Steps 5–6.

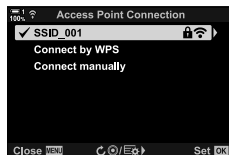

**7** Press the **OK** button to exit to the shooting display.

- The camera will return to the standard shooting display. A  icon will be displayed in the monitor.

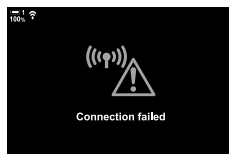

## Connecting Manually (Manual Connections)

Adjust network settings manually. You will need to provide:

<b>SSID</b>	The network name (SSID).
<b>Authentication</b>	The type of security used on the network.
<b>Password</b>	The password for connection to a secured network.
<b>IP Address Assign</b>	Choose whether the camera IP address is assigned automatically by the network DHCP server.
<b>IP Address</b>	These fields are required when the IP address is assigned manually. The settings used vary with the network.
<b>Subnet Mask</b>	
<b>Default Gateway</b>	
<b>DNS</b>	

- 1 Press the **MENU** button on the camera to display the camera menus.
- 2 Highlight [(Wi-Fi)] Wi-Fi Connect] in the [▶] playback menu and press [▶] on the arrow pad.
  - [(Wi-Fi)] Wi-Fi Connect] options will be displayed.
  - This item is only available when [On] is selected for [Wi-Fi/Bluetooth Settings] > [Availability] in the camera [⌵] setup menu.
- 3 Highlight [Access Point Connection] using the [Δ] [∇] buttons and press the **OK** button.
  - [Access Point Connection] options will be displayed.
- 4 Highlight [Connect manually] using the [Δ] [∇] buttons and press the **OK** button.

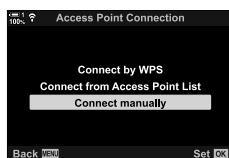

6

- 5** Highlight items using the  $\Delta$   $\nabla$  buttons and press the **OK** button.

- Options for the selected item will be displayed.

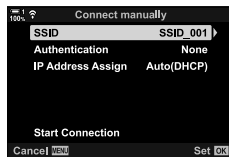

<b>SSID</b>	Enter the network SSID.
<b>Authentication</b>	Select the type of security used on the network. Choose from [None] and [WPA2].
<b>Password</b>	If you selected [WPA2] for [Authentication], enter the network password.
<b>IP Address Assign</b>	Choose from [Auto(DHCP)] and [Manual]. Automatic IP address assignment requires a network with a DHCP server configured to supply IP addresses automatically.
<b>IP Address</b>	These fields are required when [Manual] is selected for [IP Address Assign].
<b>Subnet Mask</b>	
<b>Default Gateway</b>	
<b>DNS</b>	

- 6** Highlight [Start Connection] using the  $\Delta$   $\nabla$  buttons and press the **OK** button.

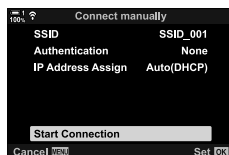

- 7** If the camera is able to connect, the network will be displayed with a check (✓) next to the network name.

- If the camera has been paired with more than one computer, you will be prompted to choose a computer before the network is displayed. Highlight the desired computer using the  $\Delta$   $\nabla$  buttons and press the **OK** button.
- The camera can be used only with the selected computer. To select a different computer, you must first terminate the current connection.
- If the connection fails, the camera will display a message to that effect, followed by the options shown in Step 6. Repeat Steps 5–6.

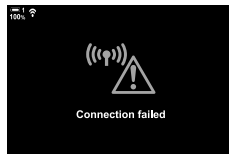
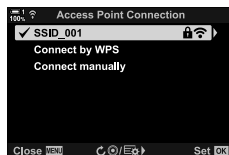

**8** Press the **OK** button to exit to the shooting display.

- Standard shooting indicators will be displayed. A  icon will appear in the monitor.

 icon



## Choosing a Network from a List



### (Connect from Access Point List)

The camera will search for available networks and display them in a list from which you can choose the network to which you wish to connect.

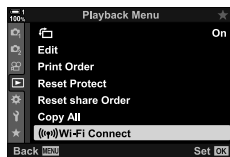
- 1 Press the **MENU** button on the camera to display the camera menus.
- 2 Highlight [(Wi-Fi) Wi-Fi Connect] in the [▶] playback menu and press [▶] on the arrow pad.
  - [(Wi-Fi) Wi-Fi Connect] options will be displayed.
  - This item is only available when [On] is selected for [Wi-Fi/Bluetooth Settings] > [Availability] in the camera [Y] setup menu.
- 3 Highlight [Access Point Connection] using the [Δ] [▽] buttons and press the **OK** button.
  - [Access Point Connection] options will be displayed.
- 4 Highlight [Connect from Access Point List] using the [Δ] [▽] buttons and press the **OK** button.
  - A list of available networks will be displayed.
- 5 Highlight the desired network using the [Δ] [▽] buttons and press the **OK** button.
  - If the network is password-protected, you will be prompted to enter a password. Enter the password and press the **OK** button.
  - Press the [▶] button to display [Detail Settings] for the highlighted network. You can enter an IP address and adjust other settings manually.
  - Press the [⊙] button to repeat the search and update the network list.







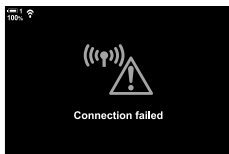

- 6** If the camera is able to connect, the network will be displayed with a check (✔) next to the network name.
- Password-protected networks are indicated by a  icon.
  - If the camera has been paired with more than one computer, you will be prompted to choose a computer before the network is displayed. Highlight the desired computer using the   buttons and press the **OK** button.
  - The camera can be used only with the selected computer. To select a different computer, you must first terminate the current connection.
  - If the connection fails, the camera will display a message to that effect, followed by the options shown in Step 5. Repeat Steps 5–6.



- 7** Press the **OK** button to exit to the shooting display.
- Standard shooting indicators will be displayed. A  icon will appear in the monitor.



#### **Connecting to Previously-Selected Networks**

- The camera will automatically reconnect to previously-selected networks when you select [Access Point Connection] via the  icon. You will not be required to supply a password.
- If multiple networks are available, the camera will connect first to the most recently-used network.
- Once the camera has connected, it will display a list of available networks with the current network shown by a check mark .
- To connect to a different network, highlight it in the list and press the **OK** button.
- If the camera has been paired with more than one computer on the network, you will be prompted to choose a computer before the network list is displayed. Highlight the desired computer using the   buttons and press the **OK** button.

# Uploading Pictures as They Are Taken

Take pictures and upload them to a computer on the same network as the camera. Before proceeding, connect the camera and computer as described in “Pairing the Computer with the Camera (New Link)” (P. 603).

- 1 Launch “OLYMPUS Capture” on destination computer.
  - If prompted to choose a connection type, click [Wi-Fi Connection].
  - The computer will display the message, [Camera connected] when the camera is detected.



[Wi-Fi Connection]

- The camera will display the message shown at right when a connection is established.

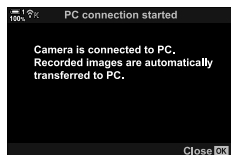

- 2 Configure “OLYMPUS Capture” to automatically download pictures as they are taken.
  - Select the source card slot (1 or 2) and the type of pictures (JPEG photos, RAW photos, or movies) to be downloaded.
  - Choose a destination for the downloaded pictures.



The “OLYMPUS Capture” control window

- 3 Take pictures using camera controls.
  - The pictures will be uploaded to the computer after they are saved to the camera memory card.
  - A **PC** (“image upload”) icon will be displayed while upload is in progress.
  - The camera will upload only photos and movies recorded while the camera and computer are connected. Any pictures taken before Wi-Fi was enabled on the camera will not be uploaded.

Image upload

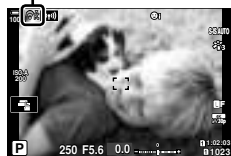

- While the camera is connected to a network:
  - Sleep mode is disabled
  - Interval-timer photography is not available
  - Some restrictions apply to the options available during playback
- [PC connection ended] options will be displayed when the camera's connection to the network ends. Upload of any remaining data will resume when the connection is re-established. Note, however, that remaining data will not be uploaded if:
  - The Wi-Fi connection is ended using camera controls
  - The camera is turned off
  - The source memory card is removed
- The upload queue for each card can contain no more than 3000 pictures.
- If "OLYMPUS Capture" displays the message [This application is unable to find a camera in the camera control mode.], check:
  - that the camera has been paired with the computer,
  - that you selected the correct computer when connecting to the network, and
  - that the camera is registered with the computer (Windows only).  "Readying the Computer (Windows)" (P. 602)

## Ending the Connection

End the Wi-Fi connection. The use of Wi-Fi may be prohibited in some countries or regions, in which case Wi-Fi should be disabled.

### Ending the Current Connection

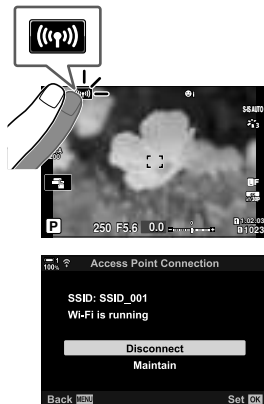

1 Tap  in the camera monitor.



- You will be prompted to confirm whether you wish to disconnect.
- The network SSID is shown in the display.

2 Highlight [Disconnect] using  $\Delta$   $\nabla$  on the arrow pad and press the **OK** button.

- The camera will terminate the connection and exit to the shooting display.
- A confirmation dialog will be displayed if data remain to be uploaded. To terminate the connection, highlight [Yes] and press the **OK** button.

3 To reconnect, tap  or select [ Wi-Fi Connect] > [Access Point Connection] in the  playback menu and press the **OK** button.

- The camera will automatically reconnect to previously-selected networks.
- To connect to a new network, highlight [Maintain] in Step 2 and press the **OK** button. Choose from a list of available networks and adjust settings as described in “Choosing a Network from a List (Connect from Access Point List)” (P. 612).
- If you turn the camera off while upload is in progress, you will be prompted to choose whether to power the camera down and terminate the Wi-Fi connection immediately or to power the camera down only after upload is complete.

## Disabling Wi-Fi/Bluetooth®

- 1 Press the **MENU** button to display the menus.
- 2 Highlight [Wi-Fi/Bluetooth Settings] in the **Y** setup menu and press **▶** on the arrow pad.
  - [Wi-Fi/Bluetooth Settings] options will be displayed.
- 3 Highlight [Availability] using the **Δ** **∇** buttons and press the **▶** button.
- 4 Highlight [Off] using the **Δ** **∇** buttons and press the **OK** button.

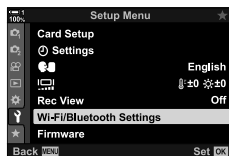

## 6-4 Network Settings

Change the password used for Wi-Fi connections from a smartphone or restore default Wi-Fi settings used for connection to a computer. The latter are not restored when a camera reset is performed and can only be restored as described below.

### Changing Passwords (Connection Password)

Generate new passwords for use when connecting to the camera from a smartphone via Wi-Fi or **Bluetooth®**.

- 1 Press the **MENU** button to display the menus.
- 2 Highlight [Wi-Fi/Bluetooth Settings] in the  $\updownarrow$  setup menu and press  $\triangleright$  on the arrow pad.
  - [Wi-Fi/Bluetooth Settings] options will be displayed.
- 3 Highlight [Connection Password] using the  $\Delta \nabla$  buttons and press the  $\triangleright$  button.
  - The current password will be displayed.

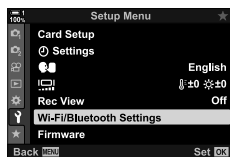

- 4 Press the  $\odot$  (movie) button.
  - The password changes each time the button is pressed.
  - Both the Wi-Fi and **Bluetooth®** passwords change.
  - Press the **OK** button to exit the [Connection Password] display.
- 5 Press the **OK** button again to exit the [Wi-Fi/Bluetooth Settings] menu.
  - Press the **MENU** button repeatedly to exit the menus.
  - After changing the password, you will need to update smartphone connection settings (P. 586).

# Restoring Default Wi-Fi/Bluetooth® Settings (Reset Settings)

Restore default Wi-Fi and **Bluetooth**® settings. All settings, including those for connection via a router and pairing information for the computers on the network, are reset.

- 1 Press the **MENU** button to display the menus.
- 2 Highlight [Wi-Fi/Bluetooth Settings] in the **Y** setup menu and press **▷** on the arrow pad.
  - [Wi-Fi/Bluetooth Settings] options will be displayed.
- 3 Highlight [Reset Settings] using the **△ ▽** buttons and press the **▷** button.
  - [Reset Settings] options will be displayed.
- 4 Highlight [Yes] using the **△ ▽** buttons and press the **OK** button.
  - Settings will be reset and the camera will exit to the [Reset Settings] display.
  - Both the Wi-Fi and **Bluetooth**® passwords will be reset.
- 5 Press the **MENU** button repeatedly to exit the menus.

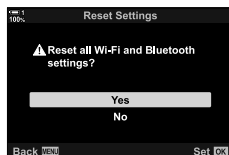
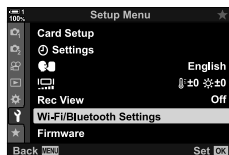

## 6-5 Connecting to Computers via USB

Connect the camera to a computer using the USB cable.

Pictures can be uploaded to the computer as they are taken and the results viewed while shooting is in progress. You can also control the camera from a computer, including taking pictures remotely while viewing camera settings in the computer display. Note that dedicated “OLYMPUS Capture” software is required for remote control of cameras connected via USB.

Pictures on the camera memory cards can be downloaded directly to the computer via USB and organized using a computer application. Use Olympus Workspace to manage your pictures.

You can also use the computer to download and perform firmware updates. Product firmware updates can be performed using Olympus Workspace.

You can also treat the connected camera as a storage device and copy data from camera memory cards to the computer.

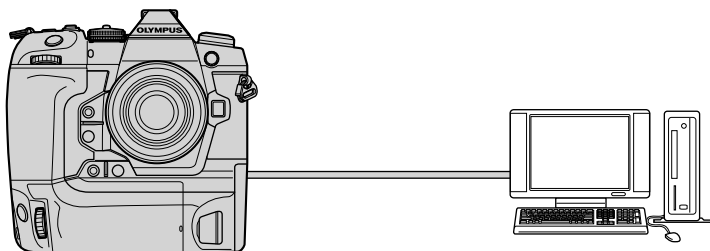



## Compatible Computers

Connect the camera to the computer using the supplied USB cable.

- Note that even if the computer is equipped with USB connectors, operation is not guaranteed with:
  - USB expansion ports, computers not running the operating system with which they shipped, or homemade computers.
- The camera can be connected to computers that meet the following system requirements.
  - Windows: Windows 7, Windows 8, Windows 8.1, Windows 10
  - Mac: OS X versions 10.9–10.11, macOS versions v10.12–v10.14

## Installing Software

Install the following software to access the camera while it is connected directly to the computer via USB.

### OLYMPUS Capture

Use “OLYMPUS Capture” to automatically download and view pictures as they are taken or control the camera remotely. To learn more or to download the software, visit the website below. When downloading the software, be prepared to provide the camera serial number.

<http://app.olympus-imaging.com/olympuscapture/>

Follow the on-screen instructions to install the software. System requirements and installation instructions are available at the website above.

### Olympus Workspace

This computer application is used to download, view, and manage photos and movies recorded with the camera. It can also be used to update the camera firmware. The software can be downloaded from the website below. Be prepared to provide the camera serial number when downloading the software.

<https://support.olympus-imaging.com/owdownload/>

Connect the camera to a computer via USB to upload pictures as they are taken. You can take pictures using the controls on the camera body or while controlling the camera remotely from the computer.

## 1 After confirming that the camera is off, connect it to the computer using the USB cable.

- Use the supplied cable protector and cable clip to prevent damage to the connectors when the USB cable is connected. “Attaching Cable Protectors” (P. 29)

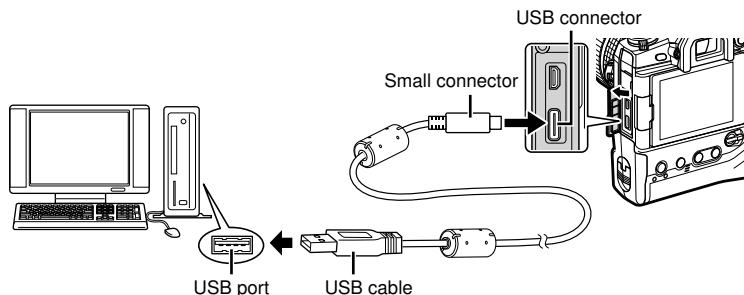

- The locations of USB ports vary from computer to computer. See the documentation provided with the computer for information on USB ports.

## 2 Turn the camera on.

- The camera will display a message prompting you to identify the device to which the USB cable is connected.
- If the message is not displayed, select [Auto] for [USB Mode] (P. 529) in Custom Menu **D4**.
- If the batteries are very low, the camera will not display a message when connecting to a computer. Be sure the batteries are charged.

## 3 Highlight using on the arrow pad and press the **OK** button.

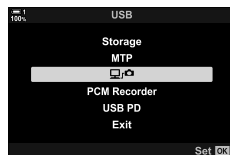

**4** Launch the copy of “OLYMPUS Capture” installed on the computer.

- When prompted to choose the connection type, click [USB Connection].



[USB Connection]

**5** Configure “OLYMPUS Capture” for download.

- Choose a destination for the downloaded pictures.

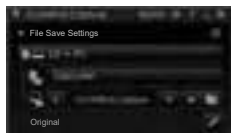

The “OLYMPUS Capture” control window

**6** Take pictures using camera or computer controls.

- The pictures will be downloaded to the computer according to the options chosen.
- The computer cannot be used to change the camera shooting mode.
- The computer cannot be used to delete pictures from the memory cards inserted in the camera.
- The camera display frame rate may drop if the view through the camera lens is displayed simultaneously both on the computer and in the camera monitor.
- See online help for more information on using the software.
- The connection to the computer will end if you:
  - exit “OLYMPUS Capture”,
  - insert or remove memory cards, or
  - turn the camera off.



## Copying Pictures to the Computer (Storage)

When connected to a computer, the camera can function as external storage in much same way as a hard drive or other external storage device. Data can be copied from the camera to the computer.

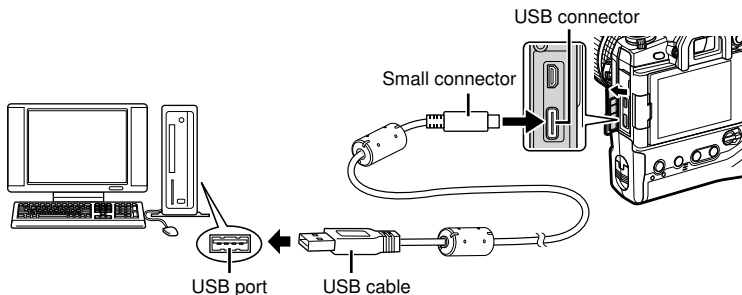
- 1 After confirming that the camera is off, connect it to the computer using the USB cable.
  - Use the supplied cable protector and cable clip to prevent damage to the connectors when the USB cable is connected.  "Attaching Cable Protectors" (P. 29)



- The locations of USB ports vary from computer to computer. See the documentation provided with the computer for information on USB ports.

- 2 Turn the camera on.
  - The camera will display a message prompting you to identify the device to which the USB cable is connected.
  - If the message is not displayed, select [Auto] for [USB Mode] (P. 529) in  Custom Menu **D4**.
  - If the batteries are very low, the camera will not display a message when connecting to a computer. Be sure the batteries are charged.
- 3 Highlight [Storage] using   on the arrow pad and press the **OK** button.

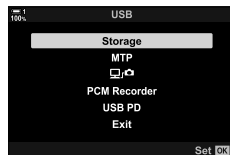

- 4 The camera will connect to the computer as new storage device.
  - To use Windows Photo Gallery, select [MTP] in Step 3.
  - Camera functions cannot be used while the camera is connected to the computer.
  - To enable the use of camera functions while the camera is connected, select  (P. 622).

## 6-6 Powering the Camera via USB (USB Power Delivery)

Mobile batteries or USB AC adapters conforming to the USB Power Delivery (USB PD) standard can be used to power the camera. The devices must:

Standard: Conform to the USB Power Delivery (USB PD) standard

Output: Be rated for an output of 9 V 3 A, 15 V 2 A, or 15 V 3 A

- This feature cannot be used at battery levels of 10% or less.

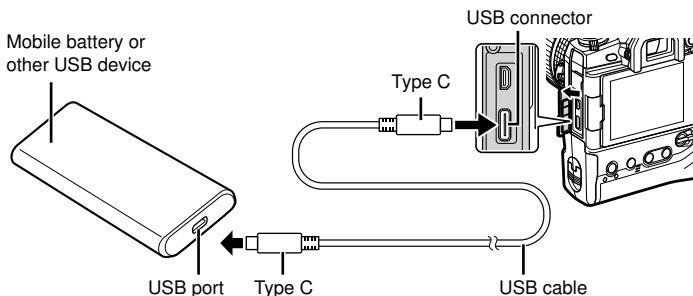

**1** After confirming that the camera is off, use the USB cable to connect it to the device.

- Use the supplied cable protector and cable clip to prevent damage to the connectors when the USB cable is connected.  “Attaching Cable Protectors” (P. 29)



- The supplied USB cable (CB-USB11) cannot be used for USB Power Delivery (USB PD).
- The method used for connection varies from device to device. See the documentation provided with the device for details.
- You may be unable to use USB Power Delivery (USB PD) with some USB devices. See the manual supplied with the USB device.

**2** Turn the camera on.

- The camera will display a message prompting you to identify the device to which the USB cable is connected.
- If the message is not displayed, select [Auto] for [USB Mode] (P. 529) in  Custom Menu .
- If the batteries are very low, the display will remain blank when the camera is connected to the USB device. Be sure the batteries are charged.

**3** Highlight [USB PD] using   on the arrow pad and press the OK button.

- The camera will draw power from the connected USB device.

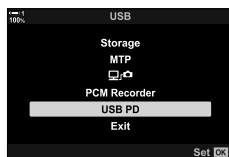

## 6-7 Connecting to TVs or External Displays via HDMI

Pictures can be displayed on televisions connected to the camera via HDMI. Use the television to display pictures to an audience. The TV remote can be used to control the display while the television is connected to the camera. No app or other software is required.

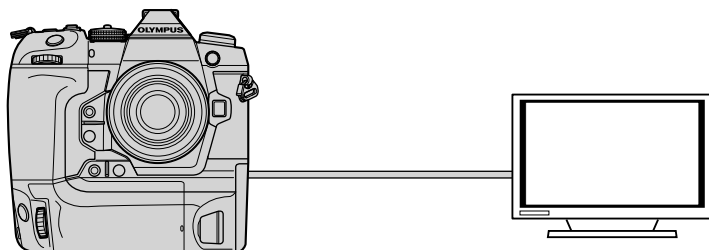

You can also film movies while the camera is connected to an external monitor or video recorder via HDMI. For more information, see page 434.

- HDMI cables are available from third-party suppliers. Use an HDMI-certified cable.

Photos and movies can be viewed on a high-definition TV connected directly to the camera by means of an HDMI cable. A remote control can be used to operate the display while it is connected to the camera.

## HDMI Output

Choose the signal output to the HDMI device. You can adjust movie frame size and frame rate to match TV specifications and the video standards supported in your country or region. Match output settings to the input settings on the TV.

<b>Output Size</b>	The format for the video signal output via the HDMI connector can be chosen from the options below. <ul style="list-style-type: none"> <li>• [C4K]: 4K Digital Cinema (4096 × 2160)</li> <li>• [4K]: 4K (3840 × 2160) priority</li> <li>• [1080p]: Full High Definition (1080p) priority</li> <li>• [720p]: High Definition (720p) priority</li> <li>• [480p/576p]: 480p/576p</li> </ul>
<b>HDMI Control</b>	When the camera is in playback mode, it can be operated using the television remote control (P. 630). Choose from [Off] and [On]. When [On] is selected, the camera can be used for playback only.
<b>Output Frame Rate</b>	Choose a frame rate for the signal output via the HDMI connector according to whether the television supports NTSC (60p) or PAL (50p).

- [HDMI Control] and [Output Frame Rate] settings cannot be changed while the camera is connected to another device via HDMI.
- Audio can be output only on devices that support the audio format selected with the camera.
- The options available via [HDMI Control] vary with the device connected. See the device manual for details.

**1** Press the **MENU** button to display the menus.

**2** Display **⚙ Custom Menu D4 (Disp./■)/PC**.

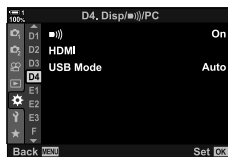

6

**3** Highlight [HDMI] using **△ ▽** on the arrow pad and press the **▶** button.

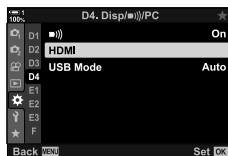

- 4 Highlight an item using the  $\Delta$   $\nabla$  buttons and press the  $\triangleright$  button.

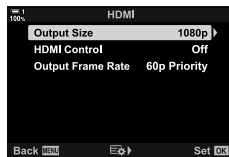

- 5 Highlight the desired option using the  $\Delta$   $\nabla$  buttons and press the **OK** button.
- Repeat Steps 4 and 5 as required.

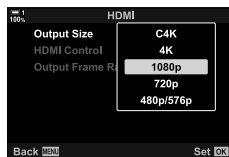

- 6 Press the **MENU** button repeatedly to exit the menus.





## Connecting the Camera to a TV

Connect the camera using an HDMI cable.

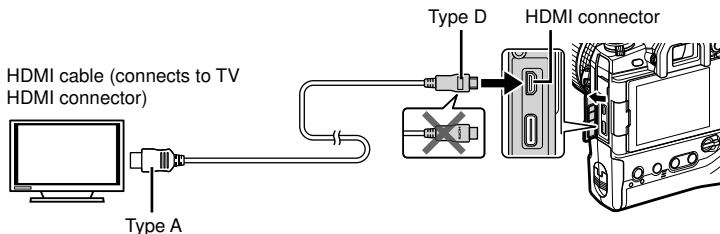
- 1 After confirming that the camera is off, connect it to the TV using an HDMI cable.
  - Use the supplied cable protector and cable clip to prevent damage to the connectors when an HDMI cable is connected.  “Attaching Cable Protectors” (P. 29)



- 2 Switch the TV to HDMI input and turn the camera on.
  - The TV will show the contents of the camera monitor. Press the  button to view pictures.
  - If [On] is selected for [HDMI Control] (P. 630), the camera monitor will turn off when an HDMI cable is connected.
  - For information on switching to HDMI input, see the manual provided with the TV.
  - Depending on TV settings, the image may be cropped and some indicators may not be visible.
  - HDMI cannot be used while the camera is connected to a computer via USB.
  - If [Record Mode] is selected for [ HDMI Output] (P. 432) > [Output Mode] in the  video menu, the signal will be output at the current movie frame size. No image will be displayed if the TV does not support the selected frame size.
  - If [4K] or [C4K] is selected, 1080p priority format will be used during still photography.

When connected to a TV via an HDMI cable, the camera can be operated using the television remote control.

- The television must support HDMI control. See the television manual for more information.

<b>On</b>	The television remote control can be used to operate the camera in playback mode. The camera can be used for playback only.
<b>Off</b>	The television remote control cannot be used to operate the camera. Indicators appear only in the TV display.

- 1 Press the **MENU** button to display the menus.
- 2 Highlight [HDMI] in **Custom Menu D4 (Disp/■)/PC** and press **▶** on the arrow pad.
- 3 Highlight [HDMI Control] using the **▲▼** buttons and press the **▶** button.
- 4 Highlight [On] using the **▲▼** buttons and press the **OK** button.

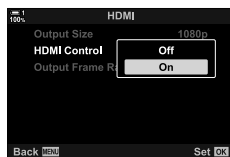
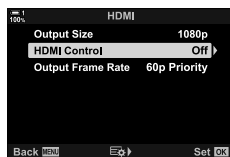
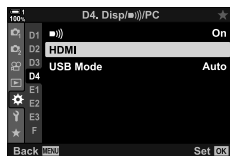

- 5 Press the **MENU** button repeatedly to exit the menus.
  - 6 Connect the camera and TV via HDMI.
    - Play pictures back using the TV remote. Follow the guide displayed on the TV screen.
    - In single-frame playback, use the "red" button to choose the information displayed and the "green" button to switch to the index display.
- Some functions may be unavailable on some televisions.
  - The camera monitor turns off while the TV is used for playback.

# 7 **Technical Notes**

---

This chapter covers such topics as camera maintenance and provides a list of default settings that you can refer to while using the camera.

# 7-1 Storage and Maintenance

## Cleaning

---

Before cleaning the camera, turn it off and remove the batteries.

- Never use chemically-treated dust cloths or strong solvents such as benzine or alcohol.

### Camera Exterior

- Gently clean the exterior with a soft cloth. To remove stubborn stains, use a cloth that has been moistened in a solution of water and neutral detergent and then thoroughly wrung out. The camera should then be dried carefully using a dry cloth. After using the camera at the seaside, clean it with a cloth that has been moistened in fresh water and then thoroughly wrung out.

### The Monitor

- Gently clean the monitor with a soft cloth.

### Lens

- Use a lens blower (available from third-party suppliers) to remove dust and lint. Clean the lens gently using a lens cleaning wipe.

## Storage

---

- Remove the batteries and memory cards before putting the camera away for an extended period. Store the camera in a cool, dry, and well-ventilated location.
- Periodically reinsert the batteries and check that the camera is functioning normally.
- Remove dust and lint from the body and rear caps before putting them in place.
- If the camera will be stored without a lens attached, attach the body cap to prevent dust entering the camera. Be sure to replace the front and rear caps on the lens before putting it away.
- Clean the camera before putting it away.
- Do not store the camera with insect repellent.
- Do not store the camera in areas where chemicals are handled, as this could cause corrosion or other forms of damage.
- Leaving the lens dirty could encourage the growth of mold.
- If the camera has been left unused for a long period of time, inspect all parts before use. Be sure to take a test shot to confirm that the camera is functioning normally before using it on a trip or on other important occasions.

## Cleaning and Checking the Image Sensor

In addition to a design that prevents dust accumulating on the image sensor, the camera is equipped with a dust-reduction feature that vibrates the sensor at high frequencies to remove dust from its front surface. Dust reduction is performed automatically when the camera is turned on.

Dust reduction is also performed during pixel mapping, which is used to check the image sensor and image processing circuits. Note that because dust reduction is performed during camera startup, you should do what you can to keep the camera upright as you turn it on.

### Image Processing Check (Pixel Mapping)

Perform a simultaneous check of both the image sensor and image processing functions. For best results, perform pixel mapping no sooner than one minute after taking or viewing pictures.

- 1 Press the **MENU** button to display the menus.
- 2 Highlight [Pixel Mapping] in **Custom Menu** (Utility) and press **▶** on the arrow pad.



- 3 Press the **OK** button.
  - A progress bar ([Busy]) will be displayed while pixel mapping is in progress. The menu will be displayed when the process is complete.



- Should you inadvertently turn the camera off while pixel mapping is in progress, be sure to perform pixel mapping again after turning the camera on.

## 7-2 Troubleshooting

### **The camera does not turn on.**

#### **The batteries are not charged.**



- Charge the batteries in the battery charger.

#### **Cold temperatures have caused a temporary drop in battery performance.**

- Battery performance drops at low temperatures. Resume use after warming the batteries slightly by removing them from the camera and placing them in your pocket or other warm location.

### **No picture is taken when the shutter button is pressed.**

#### **The camera has turned off automatically.**

- The camera will enter sleep mode if no operations are performed for a set period. Press the shutter button halfway to reactivate the camera.  [Sleep] (P. 562)  
If no operations are performed for a set period after the camera has entered sleep mode, the camera will turn off.  [Auto Power Off] (P. 562)

#### **The flash is charging.**

- A  indicator blinks in the display while the flash charges. Press the shutter button after the indicator has stopped flashing.

#### **Camera controls are locked.**

- Rotating the lock lever to the lock position locks portrait-orientation buttons and other selected controls (P. 503).

## **The camera is unable to focus.**

- The camera may be unable to focus (and the monitor in-focus indicator may flash) if the subject is too close or unsuited to autofocus. Move away from your subject or focus on a high-contrast object at the same distance from the camera and recompose the shot using focus lock.

### **Subjects Unsuited to Autofocus**

The camera may be unable to focus in the following situations.

In-focus indicator flashes and camera does not focus



Subject lacks contrast



Center of frame contains very bright object

The in-focus indicator does not flash but the camera fails to focus



AF target contains objects at different distances from camera

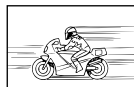

Subject is moving quickly



Subject is not in AF target.

## **Long-exposure noise reduction is enabled.**

- “Noise” (mottling) is more noticeable in photos taken at slow shutter speeds, such as can occur when shooting at night or under low light. The camera can process pictures to reduce noise after shooting; in this case no additional pictures can be taken until processing is complete. Long-exposure noise reduction can be disabled by selecting [Off] for [Noise Reduct.].  [Noise Reduct.] (P. 533)

## **The number of available AF targets is lower than usual.**

The number and size of the AF targets available varies with the options selected for [Digital Tele-converter] (P. 235, 411), [Image Aspect] (P. 233), and AF-target mode (P. 120).

## **The clock is not set.**

### **The clock was not set after purchase.**

- The clock is not set at shipment. Set the clock before using the camera for the first time.  “Setting the Camera Clock (🕒 Settings)” (P. 455)

### **The batteries have been removed from the camera.**

- The clock will be reset after the batteries have been removed from the camera for about a day. The clock will be reset sooner if the batteries are inserted for only a short period. Be sure the clock is set correctly before taking important pictures.

## Settings have been reset.

Settings adjusted in custom modes (modes **C1–C4**) will be reset to saved values when another shooting mode is selected or the camera is turned off.

## Pictures look “washed out”.

This may occur in pictures of subjects that are back-lit or partially back-lit. It is the result of phenomena known as “flare” and “ghosting”. Keep bright light sources out of the frame as much as possible. Flare may occur even when the frame does not contain a light source. Use a lens hood to prevent light from bright sources entering the lens. If this does not have the desired effect, try shading the lens with your hand or other objects.  “Interchangeable Lenses” (P. 42)

## Bright spots appear in pictures.

The image sensor may contain defective pixels. Use [Pixel Mapping]. If this does not solve the problem, try repeating the process several more times.  “Image Processing Check (Pixel Mapping)” (P. 633)

## Some menu items are unavailable.

You may be unable to select certain menu items using the arrow pad if they:

- are unavailable in the current mode or
- have been disabled due to the combination of settings currently selected, as is the case for example with mode [H] (P. 151) and [Noise Reduct.] (P. 533).

## The subject appears distorted.

The camera uses an electronic shutter:



during movie recording (P. 294), in silent (P. 163), Pro Capture (P. 168), and High Res Shot modes (P. 210), during focus bracketing (P. 239) and focus stacking (P. 243), and with the live ND filter (P. 197).

Distortion may occur if the subject or camera moves quickly during shooting. Avoid moving the camera during shooting or choose a mode that does not require the electronic shutter.

## Banding appears in pictures.







Flicker caused by fluorescent or LED lamps and certain other forms of artificial lighting be visible in pictures taking using features that employ the electronic shutter, namely:











movie recording (P. 294), silent mode (P. 163), Pro Capture (P. 168), High Res Shot (P. 210), focus bracketing (P. 239), focus stacking (P. 243), and the live ND filter (P. 197).





Flicker can be reduced by choosing slower shutter speeds. You can also reduce flicker using flicker scan.  [ Flicker Scan] (P. 193), [ Flicker Scan] (P. 374)



## 7-3 Warnings and Error Messages

Message/warning	Cause	Solution
 No Card	No memory card inserted. Also displayed if no memory card is detected.	Insert a memory card. If a card is inserted, check that it is inserted correctly.
 ① Card Error	There is a problem with the memory card in Slot 1.	Remove and reinsert the memory card. If this does not solve the problem, format the card. If formatting fails, the card cannot be used.
 ② Card Error	There is a problem with the memory card in Slot 2.	
 ① Write Protect	The memory card in Slot 1 is write-protected ("locked").	The memory card write-protect switch is in the "LOCK" position. Return the switch to the unlocked position (P. 37).
 ② Write Protect	The memory card in Slot 2 is write-protected ("locked").	
 ① Card Full	<ul style="list-style-type: none"> <li>Shooting disabled; the memory card in Slot 1 does not have space for additional pictures.</li> <li>Shooting disabled; the memory card in Slot 1 is full.</li> </ul>	Insert another memory or delete pictures. Before deleting pictures, be sure any pictures you wish to keep have been copied to a computer. If [Dual Independent] or [Dual Same] is selected for [Save Settings], choose a different setting.
 ② Card Full	<ul style="list-style-type: none"> <li>Shooting disabled; the memory card in Slot 2 does not have space for additional pictures.</li> <li>Shooting disabled; the memory card in Slot 2 is full.</li> </ul>	

Message/warning	Cause	Solution
 ① No Picture	Playback unavailable; the memory card in Slot 1 contains no pictures.	The selected memory card contains no pictures. Take pictures before choosing playback mode.
 ② No Picture	Playback unavailable; the memory card in Slot 2 contains no pictures.	
 ① Picture Error	The selected file is damaged and cannot be played back. Alternatively, the picture is in a format that is not supported by the camera.	View the picture using computer imaging software or the like. If the picture cannot be displayed on a computer, the file may be corrupt.
 ② Picture Error		
 ① The Image Cannot Be Edited	Camera retouch features cannot be applied to pictures recorded with other devices.	Retouch the picture on a computer or other device.
 ② The Image Cannot Be Edited		
 Logging function cannot be used at this time.	The batteries are low.	Charge the batteries or insert fully-charged spare batteries.
 ① Card log capacity is full	No additional logs can be saved to the memory card in Slot 1.	Copy log files to a computer and delete unwanted log files.
 ② Card log capacity is full	No additional logs can be saved to the memory card in Slot 2.	
 (steady)	GPS error. The camera's GPS has malfunctioned.	Turn the camera off and then on again; if the warning does not clear from the display, take the camera to an Olympus-authorized service representative.

Message/warning	Cause	Solution
		Turn the camera off and wait for it to cool.
 Internal camera temperature is too high. Please wait for cooling before camera use.	The camera's internal temperature is elevated following burst shooting or the like.	The camera is about to turn off automatically. Wait until the camera has cooled and is ready to resume shooting.
 Battery Empty	The batteries are exhausted.	Charge the batteries.
 No Connection	There is a problem with the camera's connection to a computer or HDMI device.	Reconnect the camera.
The lens is locked. Please extend the lens.	A retractable lens is attached but not extended.	Extend the lens.
Please check the status of a lens.	An error has occurred between the camera and the lens.	Turn the camera off and check that the lens is properly connected before turning the camera on again.

# 7-4 Default Settings

\*1: Can be saved using [Assign to Custom Mode].

\*2: Default setting can be restored using [Reset] (full).













\*3: Default setting can be restored using [Reset] (basic).

## Live Controls/LV Super Control Panel

Shooting mode	Item	Default	*1	*2	*3		
P/A/S/M/B	ISO	Auto	✓	✓	✓	181	
	Flash Mode		✓	✓	✓	254	
		±0	✓	✓	✓	259	
	Manual Value	FULL (flash set to  MANUAL])	✓	✓	✓	254	
	Image Stabilizer	S-IS Auto	✓	✓	✓	176	
	WB	Auto ([On] selected for   Keep Warm Color])	✓	✓	✓	202	
	WB compensation A	±0	✓	✓	—	206	
	WB compensation G	±0	✓	✓	—	206	
	Kelvin	5400K ([CWB] selected for  [WB])	✓	✓	—	202	
	AF Area	Center/single	✓	✓	✓	123	
	AF Mode	S-AF	✓	✓	✓	115	
	Face Priority	Face & Eye Priority On	✓	✓	—	133	
		Single	✓	✓	✓	151	
	Metering		✓	✓	✓	186	
	Save Settings	Standard	✓	✓	—	72	
		①	F (High Res Shot:  F+RAW)	✓	✓	✓	78
		②	F (High Res Shot:  F+RAW)	✓	✓	✓	78
	Picture Mode	Natural	✓	✓	✓	215	
	Sharpness	±0	✓	✓	—	220	
	Contrast	±0	✓	✓	—	221	
	Saturation	±0	✓	✓	—	222	
	Gradation	Gradation Normal	✓	✓	—	223	
	Effect	— ([i-Enhance] selected for [Picture Mode]:  Standard)	✓	✓	—	226	
	Color Filter	— ([Monochrome] selected for [Picture Mode]: N:None)	✓	✓	✓	224	
	Monochrome Color	— ([Monochrome] selected for [Picture Mode]: N:Normal)	✓	✓	✓	225	
	Image Aspect	4:3	✓	✓	✓	233	
	Color Space	sRGB	✓	✓	✓	232	
	Highlight&Shadow Control	(±0)	✓	✓	✓	227	
	Movie	On	✓	✓	✓	413	

Shooting mode	Item	Default	*1	*2	*3		
(movie)	ISO	[P], [A], or [S] selected for [ Mode]: Auto (fixed) [M] selected for [ Mode]: 200	—	✓	✓	369	
	Flash Mode	Flash Off (fixed)	—	—	—	—	
	Image Stabilizer	±0 (fixed)	—	—	—	—	
	Image Stabilizer	M-IS	✓	✓	✓	376	
	WB	Auto ([On] selected for [ WB Auto Keep Warm Color])	—	✓	✓	380	
	WB compensation A	±0	—	✓	—	384	
	WB compensation G	±0	—	✓	—		
	Kelvin	5400K ([CWB] selected for [ WB])	—	✓	—	380	
	AF Area	Center; group (3×3)	✓	✓	✓	352	
	AF Mode	C-AF	✓	✓	✓	345	
	Face Priority	Face & Eye Priority On	✓	✓	—	360	
	Metering	(fixed)	—	—	—	—	
	Picture Mode	(fixed)	✓	✓	✓	321	
	Picture Mode	Natural	✓	✓	✓	388	
	Sharpness	±0	✓	✓	—	396	
	Contrast	±0	✓	✓	—	397	
	Saturation	±0	✓	✓	—	398	
	Gradation	Gradation Normal	✓	✓	—	399	
	Image Aspect	16:9 (fixed) C4K selected for [ ]: 17:9	—	—	—	—	
	Color Space	sRGB (fixed)	—	—	—	—	
	Highlight&Shadow Control	(±0)	✓	✓	✓	403	
	Mode	P	—	✓	—	332	
	Movie	On	✓	✓	✓	413	
	RC mode	A group A	TTL	✓	✓	✓	262
		B group B	Off	✓	✓	✓	
		C group C	Off	✓	✓	✓	
		camera flash	Off	✓	✓	✓	
Flash compensation		±0 (TTL, Auto)	✓	✓	✓		
Flash level		1/1 (Manual)	✓	✓	✓		
/FP		(Normal)	✓	✓	✓		
optical signal strength		Low	✓	✓	✓		
Channel		1	✓	✓	✓		

# The Shooting Menus

Tab	Item	Default	*1	*2	*3				
	Reset / Custom Modes	Reset	—	—	✓	—	91, 111, 331, 458, 460		
		Assign to Custom Mode	Shooting mode: <b>P</b> Image quality: RAW+  F						
		Recall from Custom Mode	—						
	Picture Mode	 Natural		✓	✓	✓	215, 388		
		 F (  : RAW+  F)		✓	✓	✓	78, 82, 213, 543		
	Image Aspect	4:3		✓	✓	✓	233		
	Digital Tele-converter	Off		✓	✓	✓	235, 411		
			<input type="checkbox"/>		✓	✓	✓	151	
		Intrvl. Sh./Time Lapse	Off		—	✓	✓		
		Number of Frames	99						
		Start Waiting Time	00:00:01						
		Interval Length	00:00:01						
		Time Lapse Movie	Off						
		Movie Settings	Movie Resolution	FullHD					
			Frame Rate	10fps					
	Bracketing	Off		✓	✓	✓	236		
	AE BKT	3f 1.0EV							
	WB BKT	A–B	Off					236	
		G–M						237	
	FL BKT	Off						237	
	ISO BKT	Off						238	
	ART BKT	Off						238	
	Focus BKT	Off		✓	✓	✓		239	
	Focus Stacking	Off						243	
	Shot Count	[Off] selected for [Focus Stacking]: 99 [On] selected for [Focus Stacking]: 8						—	
	Set focus differential	5							
	 Charge Time	0 sec		✓	✓	✓			
	HDR	Off		✓	✓	✓		195	

Tab	Item	Default	*1	*2	*3		
	Multiple Exposure	Number of Frames	Off	—	✓	✓	246
		Auto Gain	Off	—	✓	✓	
		Overlay	Off	—	✓	✓	
	Keystone Comp.		Off	✓	✓	✓	248
	Anti-Shock []/ Silent []	Anti-Shock []	[]0 sec	✓	✓	—	
		Silent []	[]0 sec				
	Noise Reduction []	Noise Reduction []	Off	✓	✓	—	
		Silent [] Mode Settings	—				
			Not Allow				
		AF Illuminator	Not Allow				
	Flash Mode	Not Allow					
	High Res Shot	High Res Shot	0 sec	✓	✓	—	210
		Charge Time	0 sec				
		Shooting Method	Tripod	✓	✓	—	
	Live ND Shooting		Off	✓	✓	✓	197
ND Number		ND8 (3EV)	✓	✓	—		
LV Simulation		On	✓	✓	—		

## The Video Menu

Tab	Item	Default	*1	*2	*3		
	Mode Settings	Mode	P	—	✓	—	332
		Flicker Scan	Off	—	✓	✓	374
	Specification Settings	MOV  4K 30p		✓	✓	✓	321, 339
		ISO-Auto Set					
		Upper Limit / High Limit Default Default	6400 200	✓	✓	✓	
		ISO-Auto	Off	—	✓	—	
		Noise Filter	Standard	✓	✓	✓	379
		WB	Auto	—	✓	✓	380
		All  WB	A±0, G±0	—	✓	—	385
		Keep Warm Color	On	—	✓	✓	383
		Picture Mode	Off	✓	✓	—	393
		AF/IS Settings	AF Mode	C-AF	✓	✓	✓
	C-AF Speed		±0	✓	✓	✓	363
	C-AF Sensitivity		±0	✓	✓	✓	362
	Image Stabilizer		M-IS	✓	✓	✓	376
	IS Level		±0	✓	✓	✓	378

Tab	Item	Default	*1	*2	*3				
	Button/Dial/Lever								
	Button Function			—	✓	—	417		
		ISO	ISO						
			REC						
		Fn	[::]						
		AF-L	AF-L						
		WB	WB						
			[::]						
			Off ( <b>W↔T</b> )						
			Off (WB)						
			Peaking						
			Off						
		ISO	Off						
		AF-L	Off						
			Off						
		Off							
	Fn	AF Stop							
		Dial Function	P	Position 1	:	—	✓	424	
				Position 2	:  VOL :  VOL				
			A	Position 1	: : FNo.	—	✓		
				Position 2	:  VOL :  VOL				
			S	Position 1	: : Shutter	—	✓		
				Position 2	:  VOL :  VOL				
		M	Position 1	: FNo. : Shutter	—	✓			
			Position 2	:  VOL : ISO					
			Fn Lever Function		mode2	—	✓	426	
			mode2		AF Mode/AF Target Mode/AF Target Point				
			Shutter Function			—	✓	423	
			Elec. Zoom Speed		Normal	—	✓	408	









Tab	Item	Default	*1	*2	*3			
	Display Settings							
	Control Settings	Live Control, Live SCP	—	✓	—	428		
	Info Settings	Custom1	—	✓	—	429		
	Time Code Settings	Time Code Mode	Drop Frame	—	✓	—	324	
		Count Up	Rec Run	—	✓	—		
		Starting Time	0:00:00	—	✓	—		
	Display Pattern	min	—	✓	—	431		
	View Assist	Off	—	✓	—	395		
	Movie	On		✓	✓	✓	413	
		Recording Volume	Built-In	±0	—	✓		—
			MIC	±0	—	✓		—
		Volume Limiter	On	—	✓	—		
		Wind Noise Reduction	Off	—	✓	—		
		Recording Rate	48kHz/16bit	✓	✓	—		
		Plug-in Power	Off	—	✓	—		
		PCM Recorder	Camera Rec. Volume	Operative	—	✓		—
			Link	Slate Tone	Off	✓		✓
		Synchronized  Rec.		Off	✓	✓		—
Headphone Volume		8	✓	✓	—			
HDMI Output	Output Mode	Monitor Mode	—	✓	—	432		
	REC Bit	Off	✓	✓	—			
	Time Code	On	✓	✓	—			

## The Playback Menu

Tab	Item	Default	*1	*2	*3	
		On	✓	✓	✓	283
	Edit	—	—	—	—	284
	Print Order	—	—	—	—	291
	Reset Protect	—	—	—	—	271, 440
	Reset share Order	—	—	—	—	278, 447
	Copy All	—	—	—	—	274, 443
	Wi-Fi Connect	Device Connection	—	✓	—	586

## The Setup Menu

Tab	Item	Default	*1	*2	*3		
	Card Setup	—	—	—	—	38, 276, 445, 454	
	 Settings	 Time Zone	—	—	—	—	455
		Auto Time Adjust	Off	—	—	—	
		 Language	English	—	—	—	
	 Region	☺±0, ☺±0, Natural	☺±0, ☺±0, Natural	✓	✓	—	456
	Rec View		Off	✓	✓	—	90, 456
	Wi-Fi/Bluetooth Settings	Availability	On	—	✓	—	457, 586, 607
		Connection Password	—	—	—	—	
		Power-off Standby	Off	—	✓	—	
		Reset Settings	—	—	—	—	
		Wi-Fi MAC Address	—	—	—	—	
Firmware		—	—	—	—	457	

## The ⚙ Custom Menus

Tab	Item		Default	*1	*2	*3		
⚙	AF/MF							
	A1	AF Mode	S-AF	✓	✓	✓	115	
		AF+MF	Off	✓	✓	✓	481	
		AEL/AFL	S-AF	mode3	✓	✓	✓	141
			C-AF	mode4				
			MF	mode3				
			Half Way AF	Operative	✓	✓	✓	
		AF Scanner	mode2	✓	✓	✓	146, 482	
		C-AF Sensitivity	±0	✓	✓	✓	145, 483	
		C-AF Center Start	(All Targets)	✓	✓	✓	147, 483	
		C-AF Center Priority	5, 9, or 25 targets	✓	✓	✓	148, 484	
		A2	[:::]Mode Settings	All; Small; Single; 5-, 9-, or 25-target group	✓	✓	✓	485
	AF Area Pointer		On1	✓	✓	✓	486	
	AF Targeting Pad		Off	✓	✓	✓	486	
	[:::] Set Home		AF Target Mode, AF Target Point	—	✓	✓	487	
	[:::] Select Screen Settings		Set 1	✓	✓	✓	488	
				[:::]Mode				
				⊕ Pos				
				⊖ Pos				
	Target Mode Settings		1×1; vertical and horizontal step size: 1	✓	✓	—	125, 488	
	Orientation Linked [:::]		Off	✓	✓	—	489	
	A3		AF Limiter	Off	✓	✓	✓	143, 490
		Distance settings		Setting 1	✓	✓	✓	
		Release Priority		On	✓	✓	✓	
		AF Illuminator	On	✓	✓	✓	490	
		Face Priority		✓	✓	—	133, 360, 491	
		Tracking Subject	Off	✓	✓	—	149, 491	
AF Focus Adj.*		Off	✓	✓	✓	492		
A4	Preset MF distance		999.9 m	✓	✓	✓	129, 357, 494	
	MF Assist	Magnify	Off	✓	✓	—	495	
		Peaking	Off	✓	✓	—		
	MF Clutch	Operative	✓	✓	✓	128, 356, 496		
	Focus Ring		✓	✓	✓	496		
	Bulb/Time Focusing	On	✓	✓	✓	107, 497		
Reset Lens	On	✓	✓	✓	497			

\* Using [Reset] to perform a full or standard reset does not affect saved values.

Tab	Item		Default	*1	*2	*3		
* B1	Button/Dial/Lever							
	Button Function		ISO	ISO	✓	✓	—	463
			REC	REC				
			[Fn]	[Fn]				
			AEL/AF-L	AEL/AF-L				
			WB	WB				
			[Fn]	[Fn]				
			Off (Flash)	Off (Flash)				
			Off (Flash)	Off (Flash)				
			Macro	Macro				
			Macro	Macro				
			ISO	ISO				
			AEL/AF-L	AEL/AF-L				
			Macro	Macro				
			Macro	Macro				
			AF Stop	AF Stop				
		Center Button	Off	✓	✓	—	499	
		Direction Key	[Fn]	✓	✓	—	499	
	Dial Function	P	Position 1	: ISO : WB	✓	✓	—	473, 500
			Position 2	: ISO : WB				
		A	Position 1	: ISO : FNo.				
			Position 2	: ISO : WB				
		S	Position 1	: ISO : Shutter				
			Position 2	: ISO : WB				
		M/B	Position 1	: FNo. : Shutter				
			Position 2	: ISO : ISO				
			Menu	: ISO : Value	—	✓	—	
			Prev/Next	: ISO : Q				
	Dial Direction	Exposure	Dial1	✓	✓	—	500	
		Ps	Dial1					
	Fn Lever Function	mode2	mode2	—	✓	—	475, 501	
		mode2	AF Mode/AF Target Mode/ AF Target Point					
		Fn Lever/Power Lever	Fn	—	✓	—	501	

Tab	Item	Default	*1	*2	*3	👉	
* B2	📷 Elec. Zoom Speed	Normal	✓	✓	—	502	
	C-LOCK Settings	—	✓	✓	—	503	
Release//Image Stabilizer							
C1	S-AF Release Priority	Off	✓	✓	✓	505	
	C-AF Release Priority	On	✓	✓	✓	505	
	L Settings					155, 506	
	/📷	Max fps	10 fps	✓	✓		✓
		Frame Count Limiter	Off	✓	✓		✓
	♥	Max fps	18 fps	✓	✓		✓
		Frame Count Limiter	Off	✓	✓		✓
	Pro Cap	Max fps	18 fps	✓	✓		✓
		Pre-shutter Frames	8	✓	✓		✓
		Frame Count Limiter	25	✓	✓		✓
	H Settings						155, 507
		Max fps	15 fps	✓	✓	✓	
		Frame Count Limiter	Off	✓	✓	✓	
	♥	Max fps	60 fps	✓	✓	✓	
		Frame Count Limiter	Off	✓	✓	✓	
Pro Cap	Max fps	60 fps	✓	✓	✓		
	Pre-shutter Frames	14	✓	✓	✓		
	Frame Count Limiter	25	✓	✓	✓		
Flicker reduction	Anti-Flicker LV	Auto	✓	✓	—	190, 509	
	Anti-Flicker Shooting	Off	✓	✓	—		
C2	📷 Image Stabilizer	S-IS AUTO	✓	✓	✓	176, 510	
	Image Stabilization	Fps Priority	✓	✓	—	174, 511	
	Half Way Rls With IS	On	—	✓	—	178, 511	
	Lens I.S. Priority	Off	✓	✓	—	512	
Disp//PC							
D1	📷 Control Settings	Live SCP	✓	✓	—	513	
	/Info Settings	▶ Info	Image Only, Overall	✓	✓	✓	515
		▶🔍 Info	Magnify Frame, Magnify Scroll, Select Frame	—	✓	—	
		LV-Info	Image Only, Custom1, Custom2	✓	✓	—	
		Information during half way	On	✓	✓	—	
		LV OFF-Info	Off	✓	✓	—	
	Settings	25, Calendar	✓	✓	—		
	Picture Mode Settings	All selected	✓	✓	—	520	
	/🔄 Settings	♥, 📷H, ♥H, Pro CapH, L, ♥L, Pro CapL, 📷S, 📷C, 📷	✓	✓	—	520	
	Multi Function Settings	All on except WB and ISO	✓	✓	—	521	

Tab	Item		Default	*1	*2	*3			
*	D2	Live View Boost	Manual Shooting	Off	✓	✓	✓	200, 521	
			Bulb/Time	On2, Frame Rate Priority					
			Live Composite	Off					
			Others	Off					
		Art LV Mode		mode1	✓	✓	—	522	
		Frame Rate		Normal	✓	✓	✓	175, 522	
		LV Close Up Settings	LV Close Up Mode	mode2	✓	✓	—	139, 523	
			Live View Boost	Off	✓	✓	—		
		Default Setting		Recently	—	✓	—	523	
		Settings	Lock	Off	✓	✓	—	524	
	Live View Boost		Off	✓	✓	—			
	D3	Grid Settings	Display Color	Preset 1	✓	✓	—	524	
			Displayed Grid	Off	✓	✓	—		
			Apply Settings to EVF	On	✓	✓	—		
		Peaking Settings	Peaking Color	Red	✓	✓	—	525	
			Highlight Intensity	Normal					
			Image Brightness Adj.	Off					
		Histogram Settings	Highlight	255	✓	✓	—	526	
			Shadow	0					
		Mode Guide		Off	✓	✓	—	526	
		Selfie Assist		On	✓	✓	—	527	
D4			On	✓	✓	✓	527		
		HDMI	Output Size	1080p	—	✓		—	434, 528, 627
			HDMI Control	Off	—	✓		—	
		Output Frame Rate	60p Priority	—	—	—			
	USB Mode		Auto	—	✓	✓	529		
Exp/ISO/BULB/									
E1	EV Step		1/3EV	✓	✓	✓	530		
	ISO Step		1/3EV	✓	✓	✓	530		
	ISO-Auto Set	Upper Limit / Default	High Limit: 6400 Default: 200	✓	✓	✓	183, 531		
		Lowest S/S Setting	Auto	✓	✓	✓			
	ISO-Auto		All	✓	✓	—	185, 531		
	Noise Filter		Standard	✓	✓	✓	532		
	Low ISO Processing		Drive Priority	✓	✓	✓	532		
	Noise Reduct.		Auto	✓	✓	✓	533		

Tab	Item	Default	*1	*2	*3		
* E2	Bulb/Time Timer	8 min	✓	✓	✓	533	
	Bulb/Time Monitor	-7	✓	✓	—	534	
	Live Bulb	Off	✓	✓	—	534	
	Live Time	0.5 sec	✓	✓	—	535	
	Composite Settings	1 sec	✓	✓	—	110, 535	
	Flicker Scan	Off	✓	✓	—	536	
	E3 Metering		✓	✓	✓	186, 536	
	AEL Metering	Auto	✓	✓	✓	537	
	[••] Spot Metering	Spot	On	✓	✓	✓	537
		Spot Highlight	On	✓	✓	✓	
		Spot Shadow	On	✓	✓	✓	
	Exposure Shift		±0	✓	✓	—	538
			±0				
			±0				
Custom							
F	X-Sync.	1/250	✓	✓	✓	260, 539	
	Slow Limit	1/60	✓	✓	✓	261, 539	
	+	Off	✓	✓	✓	540	
	+WB	Off	✓	✓	—	540	
	RC Mode	Off	✓	✓	✓	541	
/WB/Color							
G	Set	-1:  SF -2:  F -3:  N -4:  M	✓	✓	✓	81, 542	
	Pixel Count	Middle	3200×2400	✓	✓	✓	82, 543
		Small	1280×960				
	Shading Comp.	Off	✓	✓	✓	543	
	WB	Auto	✓	✓	✓	544	
	All	A±0, G±0	✓	✓	—	545	
Auto Keep Warm Color	On	✓	✓	✓	205		
Color Space	sRGB	✓	✓	✓	232		

Tab	Item	Default	*1	*2	*3			
	Record/Erase							
		Card Slot Settings	Save Settings	Standard	✓	✓	—	547
			Save Slot		✓	✓	—	
			Save Slot		✓	✓	—	
			Slot		✓	✓	—	
			Assign Save Folder	Do not assign	✓	✓	—	
	File Name		Reset	✓	✓	—	548	
	Edit Filename		—	✓	✓	—	548	
	dpi Settings		350dpi	✓	✓	—	549	
	Copyright Settings*	Copyright Info.	Off	✓	✓	—	549	
		Artist Name	—	—	—	—		
		Copyright Name	—	—	—	—		
	Lens Info Settings*		Off	—	✓	—	550	
		Quick Erase	Off	✓	✓	✓	551	
		RAW+JPEG Erase	RAW+JPEG	✓	✓	✓	551	
Priority Set		No	✓	✓	✓	552		
EVF								
	EVF Auto Switch		On	—	✓	—	85, 328, 553	
	EVF Adjust	EVF Auto Luminance	On	✓	✓	—		
		EVF Adjust	$\pm 0$ , $\pm 0$					
	EVF Style		Style 2	—	✓	—	554	
	Info Settings		Basic Information, Custom1, Custom2	✓	✓	—	555	
	EVF Grid Settings	Display Color	Preset 1	✓	✓	—	556	
		Displayed Grid	Off	✓	✓	—		
	Half Way Level		On	✓	✓	—	556	
S-OVF		Off	✓	✓	✓	89, 557		

\* Using [Reset] to perform a full or standard reset does not affect saved values.



Tab	Item	Default	*1	*2	*3		
*	Utility						
	<b>11</b> Pixel Mapping	—	—	—	—	558, 633	
	Press-and-hold Time	End LV	0.7 sec	✓	✓	—	558
		Reset LV  Frame	0.7 sec	✓	✓	—	
		End	0.7 sec	✓	✓	—	
		Reset  Frame	0.7 sec	✓	✓	—	
		Reset	0.7 sec	✓	✓	—	
		Reset	0.7 sec	✓	✓	—	
		Reset	0.7 sec	✓	✓	—	
		Reset	0.7 sec	✓	✓	—	
		Reset	0.7 sec	✓	✓	—	
		Call EVF Auto Switch	0.7 sec	✓	✓	—	
		End	0.7 sec	✓	✓	—	
		Insert Slate Tone	0.7 sec	✓	✓	—	
		End	0.7 sec	✓	✓	—	
		Reset	0.7 sec	✓	✓	—	
		Switch  Lock	0.7 sec	✓	✓	—	
	Call BKT Settings	0.7 sec	✓	✓	—		
	End Flicker Scan	0.7 sec	✓	✓	—		
	Level Adjust	—	—	✓	—	559	
	Touchscreen Settings	On	—	✓	—	559	
	Menu Recall	Recall	✓	✓	—	560	
	Fisheye Compensation	Off	✓	✓	—	250, 560	
	<b>12</b> Battery Settings	Battery Priority	<b>1</b> Battery	✓	✓	—	561
		Battery Status	—	—	—	—	
	Backlit LCD	Hold	✓	✓	✓	561	
	Sleep	1 min	✓	✓	✓	562	
	Auto Power Off	4 h	✓	✓	✓	562	
	Quick Sleep Mode	Off	✓	✓	—	563	
		Backlit LCD	8 sec	✓	✓		—
		Sleep	10 sec	—	—	—	
	<b>13</b> Record GPS location	Off	—	✓	—	570	
	GPS Priority	GPS accuracy	—	✓	—	564, 579	
	Elevation/ Temperature	Calibrate Elevation	—	—	✓	—	565, 578
		m/ft	m	—	—	—	
		°C/°F	°C	—	—	—	
	Field Sensor Logger	—	—	—	—	565, 571	
	Certification	—	—	—	—	566	

## 7-5 Memory Card Capacity

### Memory Card Capacity: Photos

Figures are for an 16 GB SD card used to record photos with an aspect ratio of 4:3.

Image quality	Image size (pixels)	Compression	File format	Approx. file size (MB)	Capacity (photos)
50M F+RAW	(Tripod) 10400 × 7792	Lossless	ORF	(Tripod) 168.3	(Tripod) 87
	(Handheld) 8200 × 6132			(Handheld) 121.4	(Handheld) 120
	8160 × 6120	1/4	JPEG		
	5240 × 3192	Lossless	ORI		
25M F+RAW	(Tripod) 10400 × 7792	Lossless	ORF	(Tripod) 157.6	(Tripod) 94
	(Handheld) 8200 × 6132			(Handheld) 110.6	(Handheld) 133
	5760 × 4320	1/4	JPEG		
	5240 × 3192	Lossless	ORI		
50M F	8160 × 6120	1/4	JPEG	21.7	634
25M F	5760 × 4320	1/4	JPEG	10.9	1261
RAW	5184 × 3888	Lossless	ORF	21.7	690
L SF		1/2.7	JPEG	13.1	1054
L F		1/4		8.9	1550
L N		1/8		4.6	3013
M SF		1/2.7		5.1	2697
M F		1/4		3.6	3906
M N		1/8		1.9	7397
S SF		1/2.7		2.0	6975
S F		1/4		1.4	9765
S N		1/8		0.9	16836
S SF	1280 × 960	1/2.7		JPEG	1.0
S F		1/4	0.8		18083
S N		1/8	0.5		28721
S SF		1/2.7	0.8		18779
S F	1024 × 768	1/4	JPEG	0.6	24413
S N		1/8		0.3	61032

- Capacity varies with the subject recorded and the presence or absence of print marking and the like. The display showing the number of exposures remaining may not change when pictures are taken or deleted.
- File size varies with the subject recorded.
- The maximum number of exposures remaining shown by the camera is 9999.

## Memory Card Capacity: Movies

Figures are for a 32 GB SDHC memory card.

Frame size	Compression	Frame rate	Capacity (approx.)
C4K	—	24p	17 minutes
4K	—	30p, 25p, 24p	39 minutes
FHD	A-I	30p, 25p, 24p	20 minutes
	SF	60p, 50p, 30p, 25p, 24p	1 hour 15 minutes
	F		2 hours 4 minutes
	N		3 hours 15 minutes
HD	A-I	60p, 50p, 30p, 25p, 24p	39 minutes
	SF		2 hours 22 minutes
	F		4 hours
	N		5 hours 13 minutes

- Figures are for footage recorded at the maximum frame rate. The actual bit rate varies with the frame rate and scene recorded.
- Individual movie files can be up to 4 GB in size. A new file is created when the size of the current file reaches 4 GB.
- Individual movies can be no more than 29 minutes in length.

## 7-6 Specifications

### ■ Camera

<b>Type</b>	
Type	Digital camera supporting interchangeable lenses conforming to the Micro Four Thirds system standard
Supported lenses	M.ZUIKO DIGITAL/Micro Four Thirds system lenses
Lens mount	Micro Four Thirds
35 mm format lens focal length conversion factor	Approx. 2×
<b>Image sensor</b>	
Type	4/3" Live MOS sensor
Total pixels	Approx. 21.77 million pixels
Effective pixels	Approx. 20.37 million pixels
Size (width × height)	17.4 mm × 13.0 mm
Aspect ratio	1.33 (4:3)
<b>Viewfinder</b>	
Type	Electronic viewfinder with eye sensor
Pixel count	Approx. 2360k dots
Frame coverage	100%
Eye point	Approx. 21 mm (−1 m <sup>-1</sup> )
<b>Live view</b>	
Image sensor	Live MOS sensor
Frame coverage	100%
<b>Monitor</b>	
Type	Touch-sensitive 3.0" vari-angle TFT color LCD monitor
Pixel count	Approx. 1040k dots (aspect ratio 3:2)
<b>Shutter</b>	
Type	Electronically-controlled focal-plane shutter
Shutter speed	1/8000–60 s, bulb, time
Flash sync speed	Up to 1/250 s
<b>Autofocus</b>	
Type	Hi-Speed Imager AF
Focus areas	121
Detection range	−3.5 to 20 EV (f/2.8 lens, ISO 100 equivalent)
Focus-area selection	Auto, manual

<b>Exposure control</b>	
Metering	TTL (Imager) metering Digital ESP; center-weighted; spot
Range	-2–+20 EV (f/2.8 lens, ISO100 equivalent)
Exposure modes	<b>P</b> program AE (with program shift); <b>A</b> aperture-priority AE; <b>S</b> shutter-priority AE; <b>M</b> manual; <b>B</b> (bulb, time, composite); <b>C1–C4</b> custom modes;  movie
ISO sensitivity	L64; L100; 200–25600 in steps of 1/3 or 1 EV
Exposure compensation	±5.0 EV in steps of 1/3, 1/2, or 1 EV
<b>White balance</b>	
White balance modes	Auto; preset white balance (7 types); custom; one-touch white balance (can store up to 4 measured white balance values)
<b>Storage</b>	
Media	UHS-II compliant SD, SDHC, or SDXC memory cards
File formats	Photos: JPEG (DCF2.0), RAW data Movies: MOV (MPEG-4 AVC/H.264)
Audio	Stereo linear PCM, 16 bit; sampling frequency 48 kHz (wave format) Stereo linear PCM, 24 bit; sampling frequency 96 kHz (wave format)
Supported standards	Exif 2.3, DPOF (photos)
<b>Drive</b>	
Drive modes	Single frame; sequential; anti-shock; silent; Pro Capture; self-timer; High Res Shot
Burst performance	Sequential high: Up to 15 fps Silent sequential high/Pro Capture high: Up to 60 fps
Self-timer	12 s, 2 s, or custom timer
Power saving	Time to sleep: 1 minute; time to power off: 4 hours (customizable)
<b>Playback</b>	
Display formats	Single-frame; zoom; index; calendar
<b>Wireless LAN</b>	
Supported standards	IEEE 802.11a/b/g/n/ac*
<b>Bluetooth®</b>	
Supported standards	Bluetooth Version 4.2 BLE
<b>GPS</b>	
Frequency	1575.42 MHz (GPS/QZSS) 1598.0625 MHz–1605.3750 MHz (GLONASS)
Geodetic system	WGS 84
<b>External connectors</b>	
	USB (Type C); HDMI (Type D); external flash; remote cable (ø2.5 mm mini-jack); microphone jack (ø3.5 mm stereo mini-jack); headphone jack (ø3.5 mm stereo mini-jack); DC-IN

\* Note that cameras have been developed in line with the different standards of the countries.

<b>Power supply</b>	
Battery	Li-ion battery x2
External power sources	Supports AC-5 AC adapter; USB PD compliant
<b>Dimensions/weight</b>	
Dimensions (W x H x D)	144.4 mm x 146.8 mm x 75.4 mm/5.7" x 5.8" x 3.0" (excluding protrusions)
Weight	Approx. 997 g/2.2 lb. (including two rechargeable batteries of the supplied type and two memory cards)
<b>Operating environment</b>	
Temperature	-10 °C-40 °C/14 °F-104 °F (operating); -20 °C-60 °C/-4 °F-140 °F (storage)
Humidity	30%-90% (operating); 10%-90% (storage)
Water resistance	Type: IEC Standard publication 60529 IPX1 (applies if camera is used with Olympus waterresistant lens)

## ■ Li-ion Batteries

MODEL NO.	BLH-1
Type	Rechargeable Li-ion battery
Nominal voltage	DC 7.4 V
Nominal capacity	1720 mAh
Cycle life	Approx. 500 cycles (varies with usage conditions)
Operating temperature	0 °C–40 °C/32 °F–104 °F (charging)
Dimensions (W × H × D)	Approx. 45 mm × 20 mm × 53 mm/1.8" × 0.8" × 2.1"
Weight	Approx. 74 g/0.16 lb.

## ■ Charger for Li-ion Batteries

MODEL NO.	BCH-1
Rated input	AC 100 V–240 V (50/60 Hz)
Rated output	DC 8.4 V, 1100 mA
Charging time	Approx. 2 hours (at room temperature)
Operating temperature	0 °C–40 °C/32 °F–104 °F (operating); –20 °C–60 °C/–4 °F–140 °F (storage)
Dimensions (W × H × D)	Approx. 71 mm × 29 mm × 96 mm/2.8" × 1.1" × 3.8"
Weight	Approx. 85 g/0.19 lb. (excluding power cable)

- The supplied power cable is for use exclusively with this camera. Do not use with other equipment. Do not use the camera with cables for other equipment.

- The appearance and specifications of this product are subject to change without notice or obligation on the part of the manufacturer.
- Visit the OLYMPUS website for the latest specifications.

The terms HDMI and HDMI High-Definition Multimedia Interface, and the HDMI Logo are trademarks or registered trademarks of HDMI Licensing Administrator, Inc. in the United States and other countries.

**HDMI**<sup>™</sup>  
HIGH-DEFINITION MULTIMEDIA INTERFACE

# 7-7 System Chart

## Power Supplies



**BLH-1**  
Li-ion battery



**BCH-1**  
Charger for Li-ion  
batteries

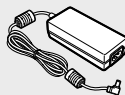

**AC-5**  
AC adapter

## Connection Cables

USB cable;  
HDMI cable\*1

## Remote Controls and Releases

**RM-CB2**  
Remote cable



## Cases and Straps

Shoulder strap;  
camera case

## Memory Cards

SD/SDHC/  
SDXC

## Headphones

## Microphones

# E-MIX

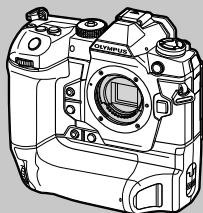

## Software

**OLYMPUS Capture**  
Camera control software

**Olympus Workspace**  
Digital photo management and editing software

7

 : E-M1X-compatible accessory

 : Available from third-party suppliers

Visit the OLYMPUS website for the latest information.

\*1 HDMI cables are available from third-party suppliers.

\*2 There are restrictions on the lenses that can be used with the adapter. Visit the OLYMPUS website for details.

\*3 Visit the OLYMPUS website for information on compatible lenses.



### Lenses



Micro Four Thirds system lenses



MMF-2/MMF-3<sup>1,2</sup>  
Four Thirds Adapter



Four Thirds system lenses

### Converter Lenses<sup>1,3</sup>

**FCON-P01**  
Fisheye

**WCON-P01**  
Wide

**MCON-P01**  
Macro

**MCON-P02**  
Macro

### Flash Units



**FL-LM3**  
Electronic flash



**FL-900R**  
Electronic flash



**FL-700WR**  
Electronic flash

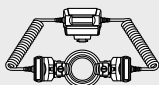

**STF-8**  
Macro flash



**FC-WR**  
Wireless radiowave commander



**FR-WR**  
Wireless radiowave receiver

# MEMO

---

---

---

---

---

---

---

---

---

---

---

---

---

---

---

---

---

---

---

---

---

---

---

---

# 8

## SAFETY PRECAUTIONS

---

The precautions in this chapter must be observed to prevent personal injury or the like. Be sure to read this chapter in its entirety.

# SAFETY PRECAUTIONS



## CAUTION

RISK OF ELECTRICAL SHOCK  
DO NOT OPEN



CAUTION: TO REDUCE THE RISK OF ELECTRICAL SHOCK, DO NOT REMOVE COVER (OR BACK). NO USER-SERVICEABLE PARTS INSIDE. REFER SERVICING TO QUALIFIED OLYMPUS SERVICE PERSONNEL.



An exclamation mark enclosed in a triangle alerts you to important operating and maintenance instructions in the documentation provided with the product.



### WARNING

If the product is used without observing the information given under this symbol, serious injury or death may result.



### CAUTION

If the product is used without observing the information given under this symbol, injury may result.



### NOTICE

If the product is used without observing the information given under this symbol, damage to the equipment may result.

### WARNING!

TO AVOID THE RISK OF FIRE OR ELECTRICAL SHOCK, NEVER DISASSEMBLE, EXPOSE THIS PRODUCT TO WATER OR OPERATE IN A HIGH HUMIDITY ENVIRONMENT.

## General Precautions

**Read All Instructions** — Before you use the product, read all operating instructions. Save all manuals and documentation for future reference.

**Power Source** — Connect this product only to the power source described on the product label.

**Foreign Objects** — To avoid personal injury, never insert a metal object into the product.

**Cleaning** — Always unplug this product from the wall outlet before cleaning. Use only a damp cloth for cleaning. Never use any type of liquid or aerosol cleaner, or any type of organic solvent to clean this product.

**Heat** — Never use or store this product near any heat source such as a radiator, heat register, stove, or any type of equipment or appliance that generates heat, including stereo amplifiers.

**Attachments** — For your safety, and to avoid damaging the product, use only accessories recommended by Olympus.

**Location** — To avoid damage to the product, mount the product securely on a stable tripod, stand, or bracket.



## WARNING

- **Do not use the camera near flammable or explosive gases.**
- **Rest your eyes periodically when using the viewfinder.**

Failure to observe this precaution could result in eyestrain, nausea, or sensations similar to motion sickness. The length and frequency of the required rest varies with the individual; use your own judgement. If you feel tired or unwell, avoid using the viewfinder and if necessary consult a physician.

- **Do not use the flash and LED (including AF illuminator) on people (infants, small children, etc.) at close range.**
  - You must be at least 1 m (3 ft.) away from the faces of your subjects. Firing the flash too close to the subject's eyes could cause a momentary loss of vision.
- **Do not look at the sun or strong lights with the camera.**

- **Keep young children, infants away from the camera.**
  - Always use and store the camera out of the reach of young children and infants to prevent the following dangerous situations which could cause serious injury:
    - Becoming entangled in the camera strap, causing strangulation.
    - Accidentally swallowing the battery, cards or other small parts.
    - Accidentally firing the flash into their own eyes or those of another child.
    - Accidentally being injured by the moving parts of the camera.
- **Should you notice that the charger is emitting smoke, heat, or an unusual noise or smell, immediately cease use and unplug the charger from the power outlet, and then contact an authorized distributor or service center.**
- **Stop using the camera immediately if you notice any unusual odors, noise, or smoke around it.**
  - Never remove the batteries with bare hands, which may cause a fire or burn your hands.
- Never hold or operate the camera with wet hands.  
This may cause overheating, exploding, burning, electrical shocks, or malfunctions.
- **Do not leave the camera in places where it may be subject to extremely high temperatures.**
  - Doing so may cause parts to deteriorate and, in some circumstances, cause the camera to catch fire. Do not use the charger if it is covered (such as a blanket). This could cause overheating, resulting in fire.
- **Handle the camera with care to avoid getting a low temperature burn.**
  - When the camera contains metal parts, overheating can result in a low-temperature burn. Pay attention to the following:
    - When used for a long period, the camera will get hot. If you hold on to the camera in this state, a low-temperature burn may be caused.
    - In places subject to extremely cold temperatures, the temperature of the camera's body may be lower than the environmental temperature. If possible, wear gloves when handling the camera in cold temperatures.
- To protect the high-precision technology contained in this product, never leave the camera in the places listed below, no matter if in use or storage:
  - Places where temperatures and/or humidity are high or go through extreme changes. Direct sunlight, beaches, locked cars, or near other heat sources (stove, radiator, etc.) or humidifiers.
  - In sandy or dusty environments.
  - Near flammable items or explosives.
  - In wet places, such as bathrooms or in the rain.
  - In places prone to strong vibrations.
- The camera can be powered by one or two Olympus lithium-ion batteries. Use only batteries of the designated type. Batteries of other types could explode (or rupture). The batteries should only be charged using the designated charger. Do not use chargers of other types.
- Never incinerate or heat batteries in microwaves, on hot plates, or in pressure vessels, etc.
- Never leave the camera on or near electromagnetic devices.  
This may cause overheating, burning, or exploding.
- Do not connect terminals with any metallic objects.
- Take precautions when carrying or storing batteries to prevent them from coming into contact with any metal objects such as jewelry, pins, fasteners, keys, etc.  
The short circuit may cause overheating, exploding, or burning, which burn or damage you.
- To prevent causing battery leaks or damaging their terminals, carefully follow all instructions regarding the use of batteries. Never attempt to disassemble a battery or modify it in any way, solder, etc.
- If battery fluid gets into your eyes, flush your eyes immediately with clear, cold running water and seek medical attention immediately.
- If you cannot remove the battery from the camera, contact an authorized distributor or service center. Do not try to remove the battery by force.  
Damage to the battery exterior (scratches, etc.) may produce heat or an explosion.
- Always store batteries out of the reach of small children and pets. If they accidentally swallow a battery, seek medical attention immediately.

- To prevent batteries from leaking, overheating, or causing a fire or explosion, use only batteries recommended for use with this product.
- If rechargeable batteries have not been recharged within the specified time, stop charging them and do not use them.
- Do not use batteries with scratches or damage to the casing, and do not scratch the battery.
- Never subject batteries to strong shocks or continuous vibration by dropping or hitting. This may cause exploding, overheating, or burning.
- If a battery leaks, has unusual odor, becomes discolored or deformed, or becomes abnormal in any other way during operation, stop using the camera, and keep away from fire immediately.
- If a battery leaks fluid onto your clothing or skin, remove the clothing and flush the affected area with clean, running cold water immediately. If the fluid burns your skin, seek medical attention immediately.
- The Olympus lithium-ion battery is designed to be used only for the Olympus digital camera. Do not use the battery to other devices.
- **Do not allow children or animals/pets to handle or transport batteries (prevent dangerous behaviour such as licking, putting in mouth or chewing).**

### Use Only Dedicated Rechargeable Battery and Battery Charger

We strongly recommend that you use only the genuine Olympus dedicated rechargeable battery and battery charger with this camera. Using a non-genuine rechargeable battery and/or battery charger may result in fire or personal injury due to leakage, heating, ignition or damage to the battery. Olympus does not assume any liability for accidents or damage that may result from the use of a battery and/or battery charger that are not genuine Olympus accessories.

### CAUTION

- **Do not cover the flash with a hand while firing.**
- Never store batteries where they will be exposed to direct sunlight, or subjected to high temperatures in a hot vehicle, near a heat source, etc.
- Keep batteries dry at all times.
- The battery may become hot during prolonged use. To avoid minor burns, do not remove it immediately after using the camera.
- This camera uses one Olympus lithium-ion battery. Use the specified genuine battery. There is a risk of explosion if the battery is replaced with the incorrect battery type.
- Please recycle batteries to help save our planet's resources. When you throw away dead batteries, be sure to cover their terminals and always observe local laws and regulations.

### NOTICE

- **Do not use or store the camera in dusty or humid places.**
- **Use SD/SDHC/SDXC memory cards only. Never use other types of cards.**  
If you accidentally insert another type of card into the camera, contact an authorized distributor or service center. Do not try to remove the card by force.
- Regularly back up important data to a computer or other storage device to prevent accidental loss.
- OLYMPUS accepts no liability for any loss of data associated with this device.
- Be careful with the strap when you carry the camera. It could easily catch on stray objects and cause serious damage.
- Before transporting the camera, remove a tripod and all other non-OLYMPUS accessories.
- Never drop the camera or subject it to severe shocks or vibrations.
- When attaching the camera to or removing it from a tripod, rotate the tripod screw, not the camera.
- Do not touch electric contacts on cameras.

- Do not leave the camera pointed directly at the sun. This may cause lens or shutter curtain damage, color failure, ghosting on the image pickup device, or may possibly cause fires.
- Do not leave the viewfinder exposed to a strong light source or direct sunlight. The heat may damage the viewfinder.
- Do not push or pull severely on the lens.
- Be sure to remove any water droplets or other moisture from the product before replacing the battery or opening or closing covers.
- Before storing the camera for a long period, remove the batteries. Select a cool, dry location for storage to prevent condensation or mold from forming inside the camera. After storage, test the camera by turning it on and pressing the shutter button to make sure that it is operating normally.
- The camera may malfunction if it is used in a location where it is subject to a magnetic/ electromagnetic field, radio waves, or high voltage, such as near a TV set, microwave, video game, loud speakers, large monitor unit, TV/radio tower, or transmission towers. In such cases, turn the camera off and on again before further operation.
- Always observe the operating environment restrictions described in the camera's manual.
- Insert the battery carefully as described in the operating instructions.
- Before loading, always inspect the battery carefully for leaks, discoloration, warping, or any other abnormality.
- Always unload the battery from the camera before storing the camera for a long period.
- When storing the battery for a long period, select a cool location for storage.
- Power consumption by the camera varies depending on which functions are used.
- During the conditions described below, power is consumed continuously and the battery becomes exhausted quickly.
  - The zoom is used repeatedly.
  - The shutter button is pressed halfway repeatedly in shooting mode, activating the auto focus.
  - A picture is displayed on the monitor for an extended period of time.
- Using an exhausted battery may cause the camera to turn off without displaying the battery level warning.
- If the battery's terminals get wet or greasy, camera contact failure may result. Wipe the battery well with a dry cloth before use.
- Always charge a battery when using it for the first time, or if it has not been used for a long period.
- When operating the camera with battery power at low temperatures, try to keep the camera and spare battery as warm as possible. A battery that has run down at low temperatures may be restored after it is warmed at room temperature.
- Before going on a long trip, and especially before traveling abroad, purchase extra batteries. A recommended battery may be difficult to obtain while traveling.

### Using the wireless LAN/Bluetooth® functions

- **Turn off the camera in hospitals and other locations where medical equipment is present.**  
The radio waves from the camera may adversely affect medical equipment, causing a malfunction that results in an accident. Be sure to disable wireless LAN/**Bluetooth**® functions in the vicinity of medical equipment (P. 617).
- **Turn off the camera when onboard aircraft.**  
Using wireless devices onboard may hinder safe operation of the aircraft. Be sure to disable wireless LAN/**Bluetooth**® functions onboard aircraft (P. 617).
- **Do not use this product where it may interfere with nearby radar systems.**

### GPS function, electronic compass

- In a location not open to the sky (inside, underground, underwater, in a forest, near high buildings) or in a location subject to strong magnetic or electric fields (near new high-voltage power lines, magnets or electrical goods, 1.5GHz mobile telephones), it may not be possible to determine measurements or generate errors.
- The altitude displayed on the measurement information screen or picture playback screen etc. is displayed/recorded based on information from pressure sensors built into camera body. Be careful since the displayed altitude is not based on GPS position measurements.

- Electronic compass errors may be caused by the effects of strong magnetic or electrical fields (such as televisions, microwaves, large motors, radio towers and high-voltage lines). To restore the electronic compass function, hold the camera firmly and move in a figure of 8 while turning your wrist over.
- Since the GPS function and electronic compass function are not required to be accurate, there is no guarantee that the measured values (latitude, longitude, compass direction etc.) are accurate.
- Some countries and regions may prohibit the acquisition of location data without prior governmental permission. In some Olympus sales areas, the camera may consequently ship with location data displays disabled. Further, each country and region has laws and regulations you must obey when using the camera abroad.

## Monitor

- Do not push the monitor forcibly; otherwise the image may become vague, resulting in a playback mode failure or damage to the monitor.
- A strip of light may appear on the top/bottom of the monitor, but this is not a malfunction.
- When a subject is viewed diagonally in the camera, the edges may appear zigzagged on the monitor. This is not a malfunction; it will be less noticeable in playback mode.
- In places subject to low temperatures, the monitor may take a long time to turn on or its color may change temporarily.  
When using the camera in extremely cold places, it is a good idea to occasionally place it in a warm place. The monitor exhibiting poor performance due to low temperatures will recover in normal temperatures.
- The monitor of this product is manufactured with high-quality accuracy, however, there may be a stuck or dead pixel on the monitor. These pixels do not have any influence on the image to be saved. Because of the characteristics, the unevenness of the color or brightness may also be found depending on the angle, but this is due to the structure of the monitor. This is not a malfunction.

## Legal and Other Notices

- Olympus makes no representations or warranties regarding any damages, or benefit expected by using this unit lawfully, or any request from a third person, which are caused by the inappropriate use of this product.
- Olympus makes no representations or warranties regarding any damages or any benefit expected by using this unit lawfully which are caused by erasing picture data.

## Disclaimer of Warranty

- Olympus makes no representations or warranties, either expressed or implied, by or concerning any content of these written materials or software, and in no event shall be liable for any implied warranty of merchantability or fitness for any particular purpose or for any consequential, incidental or indirect damages (including but not limited to damages for loss of business profits, business interruption and loss of business information) arising from the use or inability to use these written materials or software or equipment. Some countries do not allow the exclusion or limitation of liability for consequential or incidental damages or of the implied warranty, so the above limitations may not apply to you.
- Olympus reserves all rights to this manual.

## Warning

Unauthorized photographing or use of copyrighted material may violate applicable copyright laws. Olympus assumes no responsibility for unauthorized photographing, use or other acts that infringe upon the rights of copyright owners.

## Copyright Notice

All rights reserved. No part of these written materials or this software may be reproduced or used in any form or by any means, electronic or mechanical, including photocopying and recording or the use of any type of information storage and retrieval system, without the prior written permission of Olympus. No liability is assumed with respect to the use of the information contained in these written materials or software, or for damages resulting from the use of the information contained therein. Olympus reserves the right to alter the features and contents of this publication or software without obligation or advance notice.



## FCC Notice

This equipment has been tested and found to comply with the limits for a Class B digital device, pursuant to part 15 of the FCC Rules. These limits are designed to provide reasonable protection against harmful interference in a residential installation. This equipment generates, uses and can radiate radio frequency energy and, if not installed and used in accordance with the instructions, may cause harmful interference to radio communications. However, there is no guarantee that interference will not occur in a particular installation. If this equipment does cause harmful interference to radio or television reception, which can be determined by turning the equipment off and on, the user is encouraged to try to correct the interference by one or more of the following measures:

- Reorient or relocate the receiving antenna.
- Increase the separation between the equipment and receiver.
- Connect the equipment into an outlet on a circuit different from that to which the receiver is connected.
- Consult the dealer or an experienced radio/TV technician for help.
- Only the OLYMPUS-supplied USB cable should be used to connect the camera to USB enabled personal computers.

## FCC/ISED Caution

Changes or modifications not expressly approved by the party responsible for compliance could void the user's authority to operate the equipment.

This equipment must not be co-located or operated in conjunction with any other antenna or equipment except Olympus wireless equipment whose RF exposure was evaluated for this equipment.

For the latest information, please visit the Olympus website.

Website: <https://cs.olympus-imaging.jp/en/support/imsg/digicamera/download/notice/rfsimulist.cfm>

The available scientific evidence does not show that any health problems are associated with using low power wireless devices. There is no proof, however, that these low power wireless devices are absolutely safe. Low power Wireless devices emit low levels of radio frequency energy (RF) in the microwave range while being used. Whereas high levels of RF can produce health effects (by heating tissue), exposure of low-level RF that does not produce heating effects causes no known adverse health effects. Many studies of low-level RF exposures have not found any biological effects. Some studies have suggested that some biological effects might occur, but such findings have not been confirmed by additional research. IM010 has been tested and found to comply with FCC/ISED radiation exposure limits set forth for an uncontrolled environment and meets the FCC radio frequency (RF) Exposure Guidelines and RSS-102 of the ISED radio frequency (RF) Exposure rules.

## For customers in North America, Central America, South America and the Caribbean

### Declaration of Conformity

Model Number : IM010

Trade Name : OLYMPUS

Responsible Party : **OLYMPUS AMERICA INC.**

Address : 3500 Corporate Parkway, P. O. Box 610, Center Valley, PA 18034-0610, USA

Telephone Number : 484-896-5000

Tested To Comply With FCC Standards

FOR HOME OR OFFICE USE

This device complies with part 15 of FCC Rules and Innovation, Science and Economic Development Canada's licence-exempt RSS(s). Operation is subject to the following two conditions: (1) this device may not cause harmful interference, and (2) this device must accept any interference received, including interference that may cause undesired operation.

### OLYMPUS AMERICAS LIMITED WARRANTY - OLYMPUS AMERICA INC. PRODUCTS

Olympus warrants that the enclosed Olympus® imaging product(s) and related Olympus® accessories (individually a "Product" and collectively the "Products") will be free from defects in materials and workmanship under normal use and service for a period of one (1) year from the date of purchase.

If any Product proves to be defective within the one-year warranty period, the customer must return the defective Product to the authorized Olympus Repair Service Center designated by Olympus, following the procedure set forth below (See "WHAT TO DO WHEN SERVICE IS NEEDED").

Olympus, at its sole discretion, will repair, replace, or adjust the defective Product at Olympus's cost, provided that an Olympus investigation and factory inspection disclose that (a) such defect developed under normal and proper use and (b) the Product is covered under this limited warranty.

Repair, replacement, or adjustment of defective Products shall be Olympus's sole obligation and the customer's sole remedy hereunder. Repair or replacement of a Product shall not extend the warranty period provided herein, unless required by law.

Except where prohibited by law, the customer is liable and shall pay for shipment of the Products to the designated Olympus Repair Service Center. Olympus shall not be obligated to perform preventive maintenance, installation, deinstallation, or maintenance.

Olympus reserves the right to (i) use reconditioned, refurbished, and/or serviceable used parts (that meet Olympus's quality assurance standards) for warranty or any other repairs and (ii) make any internal or external design and/or feature changes on or to its products without any liability to incorporate such changes on or to the Products.

### WHAT IS NOT COVERED BY THIS LIMITED WARRANTY

Excluded from this limited warranty and not warranted by Olympus in any fashion, either express, implied, or by statute, are:

- (a) products and accessories not manufactured by Olympus and/or not bearing the "OLYMPUS" brand label (the warranty coverage for products and accessories of other manufacturers, which may be distributed by Olympus, is the responsibility of the respective manufacturer of such products and accessories in accordance with the terms and duration of such manufacturers' warranties);
- (b) any Product which has been disassembled, repaired, tampered with, altered, changed, or modified by persons other than Olympus's own authorized service personnel unless repair by others is made with the written consent of Olympus;
- (c) defects or damage to the Products resulting from wear, tear, misuse, abuse, negligence, sand, liquids, impact, improper storage, nonperformance of scheduled operator and maintenance items, battery leakage, use of non-"OLYMPUS" brand accessories, consumables, or supplies, or use of the Products in combination with non-compatible devices;

- (d) software programs;
- (e) supplies and consumables (including but not limited to lamps, ink, paper, film, prints, negatives, cables and batteries); and/or
- (f) Products which do not contain a validly placed and recorded Olympus serial number, unless they are a model on which Olympus does not place and record serial numbers.
- (g) Products shipped, delivered, purchased, or sold from dealers located outside of North America, Central America, South America and the Caribbean; and/or
- (h) Products that are not intended or authorized to be sold in North America, South America, Central America, or the Caribbean (ie. Gray Market Goods).

**WARRANTY DISCLAIMER; LIMITATION OF DAMAGES; AFFIRMATION OF ENTIRE WARRANTY AGREEMENT; INTENDED BENEFICIALLY**

EXCEPT FOR THE LIMITED WARRANTY SET FORTH ABOVE, OLYMPUS MAKES NO AND DISCLAIMS ALL OTHER REPRESENTATIONS, GUARANTIES, CONDITIONS, AND WARRANTIES CONCERNING THE PRODUCTS, WHETHER DIRECT OR INDIRECT, EXPRESS OR IMPLIED, OR ARISING UNDER ANY STATUTE, ORDINANCE, COMMERCIAL USAGE OR OTHERWISE, INCLUDING BUT NOT LIMITED TO ANY WARRANTY OR REPRESENTATION AS TO THE SUITABILITY, DURABILITY, DESIGN, OPERATION, OR CONDITION OF THE PRODUCTS (OR ANY PART THEREOF) OR THE MERCHANTABILITY OF THE PRODUCTS OR THEIR FITNESS FOR A PARTICULAR PURPOSE, OR RELATING TO THE INFRINGEMENT OF ANY PATENT, COPYRIGHT, OR OTHER PROPRIETARY RIGHT USED OR INCLUDED THEREIN. IF ANY IMPLIED WARRANTIES APPLY AS A MATTER OF LAW, THEY ARE LIMITED IN DURATION TO THE LENGTH OF THIS LIMITED WARRANTY.

SOME STATES MAY NOT RECOGNIZE A DISCLAIMER OR LIMITATION OF WARRANTIES AND/OR LIMITATION OF LIABILITY SO THE ABOVE DISCLAIMERS AND EXCLUSIONS MAY NOT APPLY. THE CUSTOMER MAY ALSO HAVE DIFFERENT AND/OR ADDITIONAL RIGHTS AND REMEDIES THAT VARY FROM STATE TO STATE.

THE CUSTOMER ACKNOWLEDGES AND AGREES THAT OLYMPUS SHALL NOT BE RESPONSIBLE FOR ANY DAMAGES THAT THE CUSTOMER MAY INCUR FROM DELAYED SHIPMENT, PRODUCT FAILURE, PRODUCT DESIGN, SELECTION, OR PRODUCTION, IMAGE OR DATA LOSS OR IMPAIRMENT OR FROM ANY OTHER CAUSE, WHETHER LIABILITY IS ASSERTED IN CONTRACT, TORT (INCLUDING NEGLIGENCE AND STRICT PRODUCT LIABILITY) OR OTHERWISE. IN NO EVENT SHALL OLYMPUS BE LIABLE FOR ANY INDIRECT, INCIDENTAL, CONSEQUENTIAL OR SPECIAL DAMAGES OF ANY KIND (INCLUDING WITHOUT LIMITATION LOSS OF PROFITS OR LOSS OF USE), WHETHER OR NOT OLYMPUS SHALL BE OR SHOULD BE AWARE OF THE POSSIBILITY OF SUCH POTENTIAL LOSS OR DAMAGE.

Representations and warranties made by any person, including but not limited to dealers, representatives, salespersons, or agents of Olympus, which are inconsistent or in conflict with or in addition to the terms of this limited warranty, shall not be binding upon Olympus unless reduced to writing and approved by an expressly authorized officer of Olympus.

This limited warranty is the complete and exclusive statement of warranty which Olympus agrees to provide with respect to the Products and it shall supersede all prior and contemporaneous oral or written agreements, understandings, proposals, and communications pertaining to the subject matter hereof.

This limited warranty is exclusively for the benefit of the original customer and cannot be transferred or assigned.

**WHAT TO DO WHEN SERVICE IS NEEDED**

The customer must contact the designated Olympus Consumer Support Team for your region to coordinate the submission of your Product for repair service. To contact your Olympus Consumer Support Team in your region please visit or call the following:

Canada:  
[www.olympuscanada.com/repair/](http://www.olympuscanada.com/repair/)  
 1-800-622-6372

United States:  
[www.olympusamerica.com/repair/](http://www.olympusamerica.com/repair/)  
 1-800-622-6372

Latin America:  
[www.olympusamericalatina.com](http://www.olympusamericalatina.com)



The customer must copy or transfer any image or other data saved on a Product to another image or data storage medium prior to sending the Product to Olympus for repair service.

IN NO EVENT SHALL OLYMPUS BE RESPONSIBLE FOR SAVING, KEEPING OR MAINTAINING ANY IMAGE OR DATA SAVED ON A PRODUCT RECEIVED BY IT FOR SERVICE, OR ON ANY FILM CONTAINED WITHIN A PRODUCT RECEIVED BY IT FOR SERVICE, NOR SHALL OLYMPUS BE RESPONSIBLE FOR ANY DAMAGES IN THE EVENT ANY IMAGE OR DATA IS LOST OR IMPAIRED WHILE SERVICE IS BEING PERFORMED (INCLUDING, WITHOUT LIMITATION, DIRECT, INDIRECT, INCIDENTAL, CONSEQUENTIAL OR SPECIAL DAMAGES, LOSS OF PROFITS OR LOSS OF USE), WHETHER OR NOT OLYMPUS SHALL BE OR SHOULD BE AWARE OF THE POSSIBILITY OF SUCH POTENTIAL LOSS OR IMPAIRMENT.

The customer should package the Product carefully using ample padding material to prevent damage in transit. Once the Product is properly packaged, ship the package to Olympus or the Olympus Authorized Repair Service Center location as instructed by the respective Olympus Consumer Support Team.

When sending Products for repair service, your package should include the following:

- 1) Sales receipt showing date and place of purchase. Handwritten receipts will not be accepted;
- 2) Copy of this limited warranty bearing the Product serial number corresponding to the serial number on the Product (unless it is a model on which Olympus does not place and record serial numbers);
- 3) A detailed description of the problem; and
- 4) Sample prints, negatives, digital prints (or files on disk) if available and related to the problem.

KEEP COPIES OF ALL DOCUMENTS. Neither Olympus nor an Olympus Authorized Repair Service Center will be responsible for documents that are lost or destroyed in transit.

When service is completed, the Product will be returned to you postage prepaid.

## 8

### PRIVACY

Any information provided by you to process your warranty claim shall be kept confidential and will only be used and disclosed for the purposes of processing and performing warranty repair services.

## For customers in Canada

For indoor use only (5150 - 5350 MHz)

## For customers in Europe

### Simple Declaration of Conformity

Hereby, OLYMPUS CORPORATION declares that the radio equipment type IM010 is in compliance with Directive 2014/53/EU.

The full text of the EU declaration of conformity is available at the following internet address: <http://www.olympus-europa.com/>



This symbol [crossed-out wheeled bin WEEE Annex IV] indicates separate collection of waste electrical and electronic equipment in the EU countries.

Please do not throw the equipment into the domestic refuse.

Please use the return and collection systems available in your country for the disposal of this product.



This symbol [crossed-out wheeled bin Directive 2006/66/EC Annex II] indicates separate collection of waste batteries in the EU countries.

Please do not throw the batteries into the domestic refuse.

Please use the return and collection systems available in your country for the disposal of the waste batteries.

For indoor use only (5150 - 5350 MHz)

### Provisions of warranty

In the unlikely event that your product proves to be defective, although it has been used properly (in accordance with the written Instruction Manual supplied with it), during the applicable national warranty period and has been purchased from an authorized Olympus distributor within the business area of OLYMPUS EUROPA SE & Co. KG as stipulated on the website: <http://www.olympus-europa.com>, it will be repaired, or at Olympus's option replaced, free of charge. In order to enable Olympus to provide you with the requested warranty services to your full satisfaction and as fast as possible, please note the information and instructions listed below:

1. To claim under this warranty please follow the instructions on <http://consumer-service.olympus-europa.com> for registration and tracking (this service is not available in all countries) or take the product, the corresponding original invoice or purchase receipt and the completed Warranty Certificate to the dealer where it was purchased or any other Olympus service station within the business area of OLYMPUS EUROPA SE & Co. KG as stipulated on the website: <http://www.olympus-europa.com>, before the end of the applicable national warranty period.
2. Please make sure your Warranty Certificate is duly completed by Olympus or an authorized dealer or Service center. Therefore, please make sure that your name, the name of the dealer, the serial number and the year, month and date of purchase are all completed or the original invoice or the sales receipt (indicating the dealer's name, the date of purchase and product type) is attached to your Warranty Certificate.
3. Since this Warranty Certificate will not be re-issued, keep it in a safe place.
4. Please note that Olympus will not assume any risks or bear any costs incurred in transporting the product to the dealer or Olympus authorized service station.
5. This Warranty does not cover the following and you will be required to pay a repair charge, even for defects occurring within the warranty period referred to above.
  - a. Any defect that occurs due to mishandling (such as an operation performed that is not mentioned in the Instruction Manual, etc.)
  - b. Any defect that occurs due to repair, modification, cleaning, etc. performed by anyone other than Olympus or an Olympus authorized service station.
  - c. Any defect or damage that occurs due to transport, a fall, shock, etc. after purchase of the product.
  - d. Any defect or damage that occurs due to fire, earthquake, flood damage, thunderbolt, other natural disasters, environmental pollution and irregular voltage sources.
  - e. Any defect that occurs due to careless or improper storage (such as keeping the product under conditions of high temperature and humidity, near insect repellents such as naphthalene or harmful drugs, etc.), improper maintenance, etc.
  - f. Any defect that occurs due to exhausted batteries, etc.
  - g. Any defect that occurs due to sand, mud, water etc. entering the inside of the product casing.
6. Olympus's sole liability under this Warranty shall be limited to repairing or replacing the product. Any liability under the Warranty for indirect or consequential loss or damage of any kind incurred or suffered by the customer due to a defect of the product, and in particular any loss or damage caused to any lenses, films, other equipment or accessories used with the product or for any loss resulting from a delay in repair or loss of data, is excluded. Compelling regulations by law remain unaffected by this.

## For customers in Mexico

The operation of this equipment is subject to the following two conditions:

- (1) it is possible that this equipment or device may not cause harmful interference, and (2) this equipment or device must accept any interference, including interference that may cause undesired operation.

## For customers in Singapore

Complies with  
IMDA Standards  
DB104634

## Trademarks

- Microsoft and Windows are registered trademarks of Microsoft Corporation.
- Mac is a trademark of Apple Inc.
- SDXC Logo is a trademark of SD-3C, LLC.
- Apical logo is a registered trademark of Apical Limited.
- Micro Four Thirds, Four Thirds, and the Micro Four Thirds and Four Thirds logos are trademarks or registered trademarks of the OLYMPUS CORPORATION in Japan, the United States, the countries of the European Union, and other countries.
- Wi-Fi is a registered trademark of the Wi-Fi Alliance.
- The Wi-Fi CERTIFIED logo is a certification mark of the Wi-Fi Alliance.



- The **Bluetooth**<sup>®</sup> word mark and logos are registered trademarks owned by the Bluetooth SIG, Inc. and any use of such marks by OLYMPUS CORPORATION is under license.
- The standards for camera file systems referred to in this manual are the "Design Rule for Camera File System/DCF" standards stipulated by the Japan Electronics and Information Technology Industries Association (JEITA).
- All other company and product names are registered trademarks and/or trademarks of their respective owners.

THIS PRODUCT IS LICENSED UNDER THE AVC PATENT PORTFOLIO LICENSE FOR THE PERSONAL AND NONCOMMERCIAL USE OF A CONSUMER TO (i) ENCODE VIDEO IN COMPLIANCE WITH THE AVC STANDARD ("AVC VIDEO") AND/OR (ii) DECODE AVC VIDEO THAT WAS ENCODED BY A CONSUMER ENGAGED IN A PERSONAL AND NON-COMMERCIAL ACTIVITY AND/OR WAS OBTAINED FROM A VIDEO PROVIDER LICENSED TO PROVIDE AVC VIDEO. NO LICENSE IS GRANTED OR SHALL BE IMPLIED FOR ANY OTHER USE. ADDITIONAL INFORMATION MAY BE OBTAINED FROM MPEG LA, L.L.C. SEE [HTTP://WWW.MPEGLA.COM](http://WWW.MPEGLA.COM)

The software in this camera may include third party software. Any third party software is subject to the terms and conditions, imposed by the owners or licensors of that software, under which software is provided to you.

Those terms and other third party software notices, if any, may be found in the software notice PDF file stored at <http://www.olympus.co.jp/en/support/img/digicamera/download/notice/notice.cfm>

# 9 Index

---

## Symbols

	(Camera control) .....	603, 622
	(DPOF) .....	291
	RC Mode .....	262, 541
	+WB .....	540
	Slow Limit .....	261, 539
	X-Sync .....	260, 539
	Display Pattern .....	431
	(Close-up playback) .....	267
	(Single-frame erase) .....	275, 444
	(Index playback) .....	268, 300, 438
	/Info Settings .....	515
	(Share Order) .....	277, 446
	(Face priority AF) .....	133, 360, 491
	H Settings .....	151, 155, 507
	L Settings .....	151, 155, 506
	Settings .....	520
	Mode Settings .....	485
	Orientation Linked [::] .....	489
	(One-touch white balance) .....	207, 386
	Movie .....	413, 415
	Still image .....	281
	Picture Mode .....	393
	mode (movie exposure mode) .....	332
	[::] Set Home .....	487
	[::] Select Screen Settings .....	488
	[::] Spot Metering .....	537
	Slot .....	547
	Default Setting .....	523
	(Image rotation) .....	283
	(Monitor brightness adjustment) .....	456
	Center Button .....	499
	[::] Target Mode Settings .....	125, 488
	Direction Key .....	499
	(Image selection) .....	279, 448
	Info Settings .....	555
	Half Way Level .....	556
	(Language) .....	455
	WB AUTO Keep Warm Color .....	
	Movie .....	383
	Still image .....	205, 545
	Settings .....	48, 455
	WB .....	540

	Settings .....	524
--	----------------	-----

## A

<b>A</b> (Aperture-Priority AE) .....	96, 335
AC adapter .....	35
Accessories .....	660
AdobeRGB .....	232, 546
AEL/AFL .....	141, 482
AEL Metering .....	537
AE lock .....	188, 373
AF Area Pointer .....	486
AF (Autofocus) .....	115, 345
AF Focus Adj. .....	492
AF illuminator .....	490
AF Limiter .....	143, 490
AF+MF .....	115, 117, 481
AF Mode .....	
Movie .....	345
Still image .....	115, 480
AF Scanner .....	146, 482
AF Targeting Pad .....	486
AF Target Mode .....	120, 349
AF Target Point .....	123, 352
AF Tracking .....	116, 346
All	
Movie .....	385
Still image .....	545
Anti-Flicker LV .....	190
Anti-Flicker Shooting .....	191
Anti-Shock [	151, 160
Aperture-Priority AE ( <b>A</b> ) .....	96, 335
ART (Art filter) .....	215, 388
Art filter .....	215, 388
Art LV Mode .....	522
Aspect ratio .....	233
Assign Save Folder .....	76, 319
Assign to Custom Mode .....	111, 458
Autofocus (AF) .....	115
Auto Power Off .....	562
Available recording time .....	655

## B

<b>B</b> (Bulb/Time) .....	104
Backlit LCD .....	561
Battery cartridge .....	24, 31



Battery charge .....	31	Compression rate .....	322
Battery level .....	431	Continuous AF .....	115, 346
Battery Settings .....	561	Contrast .....	221, 397
Beep sound .....	527	Control Settings	
BKT (Bracketing) .....	236	Movie .....	428
<b>Bluetooth</b> ® .....	582, 584	Still image .....	513
Bracketing .....	236	Copy	
BULB .....	104	All images .....	274, 443
Bulb/Time Focusing .....	107, 497	Single-frame .....	272, 441
Bulb/Time Monitor .....	534	Copyright Settings .....	549
Bulb/Time Timer .....	533	Custom Menu .....	480, 647
Button Function		Custom mode .....	111
Movie .....	417	Custom mode (C1/C2/C3/C4) .....	460
Still image .....	463, 498	Custom picture mode .....	219, 392
<b>C</b>		Custom Self-timer .....	151, 157
Cable clip .....	24	<b>D</b>	
Cable protector .....	24, 29	Dial Direction .....	500
C-AF <b>MF</b> (Continuous AF and Manual focus) .....	115, 346	Dial Function	
C-AF Center Priority .....	148, 484	Movie .....	424
C-AF Center Start .....	147, 483	Still image .....	473, 500
C-AF (Continuous AF) .....	115, 346	Digital Tele-converter .....	235, 411
C-AF Release Priority .....	505	Direct button .....	60, 305
C-AF Sensitivity		dpi Settings .....	549
Movie .....	362	DPOF .....	291
Still image .....	145, 483	<b>E</b>	
C-AF Speed .....	363	Edit .....	284, 450
C-AF+TR (AF tracking) .....	116, 346	Edit Filename .....	548
C-AF+TR <b>MF</b> (AF tracking and Manual focus) .....	116, 346	Effect .....	226, 402
Calendar playback .....	56, 268, 300, 438	Electronic Zoom .....	306, 419, 467
Camera control .....	603, 622	Elec. Zoom Speed	
Card .....	36	Movie .....	408
Card Setup .....	38, 276, 445, 454	Still image .....	502
Card Slot Settings .....	547	Elevation/Temperature .....	565, 578
Certification .....	566	Erase	
C-LOCK Settings .....	503	All images .....	276, 445
Close-up playback .....	267	Selected images .....	279, 448
Cluster AF targeting .....	486	Single-frame .....	275, 444
Color Creator .....	229, 405	EVF Adjust .....	553
Color Filter .....	224, 400	EVF Auto Switch .....	85, 328, 553
Color grading .....	393	EVF Grid Settings .....	556
Color Space .....	232, 546	EVF Style .....	554
Composite Settings .....	110, 535	EV Step .....	530
		Exif data .....	549, 550

Exposure compensation.....	180, 367
Exposure Shift.....	538
Eye priority AF.....	133, 491

## F

Face priority AF.....	133, 360, 491
Fast-motion movie.....	342
Field sensor.....	567
Field Sensor Logger.....	565, 571
File format.....	654
File Name.....	548
File size.....	654
Firmware.....	457
Fisheye Compensation.....	250, 560
Flash intensity control.....	259
Flash Mode.....	254
Flash slow limit.....	261, 539
Flash X-sync.....	260, 539
Flicker reduction.....	190, 509
Flicker Scan	
Movie.....	374
Still image.....	193, 536
Fn Lever Function	
Movie.....	426
Still image.....	475, 501
Fn Lever/Power Lever.....	501
Focus beep.....	527
Focus mode (AF Mode).....	115, 345
Focus Ring.....	496
Focus Stacking.....	243
Format.....	38

## G



GPS Priority.....	564, 579
Gradation.....	223, 399
Grid Settings.....	524

## H

Half Way Level (Viewfinder).....	556
Half Way RIs With IS.....	178, 511
HDMI.....	434, 528, 626
HDMI Control.....	630
HDMI Output.....	432
HDR.....	195
Highlight&Shadow Control.....	84, 227, 403

High Res Shot.....	151, 210
High-speed movie.....	339
Histogram display.....	84, 327
Histogram Settings.....	526

## I



IC recorder.....	415
Image Aspect.....	233
Image Overlay.....	289
Image quality	
Movie.....	321
Still image.....	78
Image quality settings.....	81, 542
Image size.....	78, 81, 82, 542, 543, 654
Image Stabilization.....	174, 511
Index playback.....	56, 268, 300, 438
<b>INFO</b> button.....	84, 265, 327
Information display	
Movie.....	329, 437
Still image.....	86, 266
Info settings	
 /Info Settings.....	515, 574
 Info Settings.....	429
 Info Settings.....	555
In-Movie Image Capture.....	451
Interchangeable lenses.....	42
Interval shooting.....	172
Intrvl. Sh./Time Lapse.....	172
IS Level.....	378
IS Mode	
Movie.....	376
Still image.....	176, 510

## ISO

Movie.....	369
Still image.....	181
ISO-Auto	
Movie.....	372
Still image.....	185, 531
ISO-Auto Set	
Movie.....	372
Still image.....	183, 531
ISO Step.....	530

## J

JPEG Edit.....	287
----------------	-----

<b>K</b>	
Keystone Comp.....	248
<b>L</b>	
Language setting (  ).....	47, 455
Lens Info Settings.....	550
Lens I.S. Priority.....	512
Level Adjust.....	559
Level Gauge.....	84, 327
Light Box.....	518
Live Bulb.....	534
LIVE BULB.....	104
Live Bulb/Time.....	104
Live composite photography.....	108
Live Control.....	68, 312, 640
Live ND Shooting.....	197
Live Time.....	535
LIVE TIME.....	104
Live View Boost.....	139, 200, 521
Location data.....	570
Log tone curve movie recording.....	393
Long exposure ( <b>B</b> Bulb/Time ).....	104
Low ISO Processing.....	532
LV Close Up Mode.....	139
LV Close Up Settings.....	139, 523
LV-Info.....	515
LV super control panel.....	62, 309, 640
<b>M</b>	
<b>M</b> (Manual Exposure).....	101, 337
Manual Exposure ( <b>M</b> ).....	101, 337
Manual focus clutch (MF clutch).....	41, 127, 355
Manual focus (MF).....	115, 116, 346
Menu.....	66, 314
Menu Recall.....	560
Metering.....	186, 536
MF.....	419, 465
MF Assist.....	495
MF Clutch.....	41, 127, 128, 355, 356, 496
MF (Manual focus).....	115, 116, 346
Mode Guide.....	526
Monochrome Color.....	225, 401
Movie  .....	409
Movie  .....	413, 415

Movie mode.....	294
Movie shooting.....	294
Multi Function.....	470
Multi Function Settings.....	521
Multiple Exposure.....	246
Multi selector.....	22, 56, 300
My Menu.....	477

## N

Noise Filter	
Movie.....	379
Still image.....	532
Noise Reduct.....	166, 533
Noise Reduction [♥].....	166
Number of storable still pictures.....	654

## O

OI.Share (OLYMPUS Image Share).....	582, 586
OI.Track (OLYMPUS Image Track).....	569, 571, 597
OLYMPUS A-GPS Utility.....	569
OLYMPUS Capture.....	582, 601, 614, 620
Olympus Workspace.....	620
Optional flash unit.....	252

## P

<b>P</b> (Program AE).....	94, 334
Partial Color.....	231
PC.....	600
Peaking.....	420, 466
Peaking Settings.....	525
Picture Mode.....	215, 388
Picture Mode Settings.....	520
Pixel Count.....	82, 543, 654
Pixel Mapping.....	558, 633
Playback	
Movie.....	300, 436
Still image.....	56, 265
Playback Menu.....	645
Playback slot.....	57, 547
Play Movie.....	436
Power-off Standby.....	590
PreMF.....	116, 346
Preset MF.....	116, 129, 346, 357

Preset MF distance.....	494
Press-and-hold Time .....	558
Preview .....	464
Printing .....	291
Priority Set .....	552
Pro capture .....	151, 168
Program AE (P) .....	94, 334
Program shift (Ps) .....	95
Protect .....	270, 439
Ps (Program shift) .....	95

## Q

Quick Erase .....	551
Quick Sleep Mode .....	563

## R

RAW .....	78, 284
RAW Data Edit .....	284
RAW+JPEG Erase .....	551
RC Mode (⚡ RC Mode) .....	262, 541
Recall from Custom Mode .....	112
Record GPS location .....	564, 570
Recording sound	
Movie .....	413, 415
Still image .....	281
Rec View .....	90, 456
Remote shooting .....	55, 297, 596
Reset .....	91, 331
Reset Lens .....	497
Reset Protect.....	271, 440
Reset share Order .....	278, 447
Rotate .....	269

## S

S (Shutter-Priority AE).....	98, 336
S-AF MF (Single AF and Manual focus) .....	115, 345
S-AF Release Priority .....	505
S-AF (Single AF).....	115, 345
Saturation .....	222, 398
Save Settings .....	72
Save Slot	
Movie .....	316
Still image .....	74

SD card.....	36
Formatting the card.....	38
Select Screen Settings ([::] Select Screen Settings) .....	488
Selfie Assist .....	527
Self-timer .....	151
Sequential shooting.....	151, 506, 507
Set Home ([::] Set Home) .....	487
Setup Menu .....	454, 646
Shading Comp.....	543
Share Order.....	277, 446
Sharpness .....	220, 396
Shooting	
Movie .....	295
Still image .....	52
Shooting Menu .....	642
Shooting modes.....	93
Shutter Function .....	423
Shutter-Priority AE (S).....	98, 336
Silent Control .....	306
Silent [♥].....	151, 163
Silent [♥] Mode Settings .....	167
Single.....	151
Single AF .....	115, 345
Sleep .....	562
Slow Limit .....	261, 539
Slow-motion movie .....	342
S-OVF.....	89, 557
Spot Metering .....	537
sRGB.....	232, 546
Storage .....	624
Super control panel .....	62, 640
Super Spot AF .....	136

## T

Test Picture .....	465
Time Code Settings .....	324
Time Lapse Movie .....	172
Time photography.....	104
Touch AF.....	54
Touch screen .....	54, 58, 298, 303
Touchscreen Settings .....	559
Touch shutter .....	54
Tracking Subject.....	149, 491
Transfer image .....	592, 614

Trimming.....	450
TV .....	626

## U

USB connection.....	34, 620
USB Mode .....	529
USB PD .....	625
User registration .....	25

## V

Video Bit Rate.....	322
Video Frame Rate .....	175, 322, 522
Video Menu .....	643
View Assist .....	395
Volume adjustment.....	58

## W

### WB

Movie .....	380
Still image .....	202, 544
WB (White balance).....	202, 544

### White balance

Movie .....	380
Still image .....	202, 544

### White balance compensation

Movie .....	384
Still image .....	206

Wi-Fi/Bluetooth Settings.....	457, 586
Wi-Fi Connect.....	582, 584, 605
Wireless LAN.....	582
Wireless Remote Control Flash.....	262

## X

X-Sync .....	260, 539
--------------	----------

## Z

Zoom frame .....	136, 364
------------------	----------

**OLYMPUS KOREA CO., LTD.**

2F-3F Majestar City 1, 12, Seocho-daero 38-gil, Seocho-gu, Seoul,  
06655, Republic of Korea  
Tel. 1544-3200  
E-mail: [hotline.okr@olympus-ap.com](mailto:hotline.okr@olympus-ap.com)  
<http://www.olympus.co.kr>

**OLYMPUS (MALAYSIA) Sdn Bhd**

512, 5th Floor, Block D, Kelana Square 17, Jalan SS 7/26, Kelana Jaya,  
47301 Petaling Jaya, Selangor, Malaysia  
Tel: (603) 7806 2173  
Fax: (603) 7803 7164  
E-mail: [service.oml@olympus-ap.com](mailto:service.oml@olympus-ap.com)  
<http://www.olympus.com.my>

**OLYMPUS (Thailand) CO., LTD.**

23/112 Sorachai Building, 27th Floor, Soi Sukhumvit 63 (Ekamai)  
Sukhumvit road Klongton Nua, Wattana, Bangkok 10110 Thailand  
Tel: (66) 2-000-7700  
E-mail: [imaging.oth@olympus-ap.com](mailto:imaging.oth@olympus-ap.com)

## **OLYMPUS AMERICA INC.**

3500 Corporate Parkway, P.O. Box 610, Center Valley, PA 18034-0610, U.S.A. Tel. 484-896-5000

### **Technical Support (U.S.A. / Canada)**

24/7 online automated help:

<http://www.olympusamerica.com/support>

Phone customer support:

Tel. 1-800-260-1625 (Toll-free)

Our phone customer support is available from

9 am to 9 pm (Monday to Friday) ET

<http://olympusamerica.com/contactus>

Olympus software updates can be obtained at:

<http://www.olympusamerica.com/digital>

## **OLYMPUS EUROPA SE & CO. KG**

Premises: Consumer Product Division

Wendenstrasse 14-18, 20097

Hamburg, Germany

Tel: +49 40-23 77 3-0 / Fax: +49 40-23 07 61

Goods delivery: Modul H, Willi-Bleicher Str. 36,

52353 Düren, Germany

Mailing address: Postfach 10 49 08,

20034 Hamburg, Germany

### **European Technical Customer Support:**

Please visit our homepage <http://www.olympus-europa.com> or call our TOLL FREE NUMBER\* : **00800 - 67 10 83 00**

for Austria, Belgium, Denmark, Finland, France, Germany, Luxemburg, Netherlands, Norway, Poland, Portugal, Spain, Sweden, Switzerland, United Kingdom.

810-800 67 10 83 00 for Russia

800 167 777 for Czech Republic

\* Please note some phone service providers do not permit access to 00800 numbers or require an additional prefix. Charges may apply here. Please contact your service provider directly for more details.

For all not listed European Countries and in case that you can't get connected to the above mentioned number, please make use of the following CHARGED NUMBERS **+49 40 - 237 73 899**

## **OLYMPUS (BEIJING) SALES & SERVICE CO.,LTD**

Customer Support: 400-650-0303 Homepage: <http://olympus-imaging.cn>

### **Customer Service Center:**

10F, K, Wah Centre, 1010 Huaihai Road(M), Xuhui District, Shanghai

Zip: 200031

## **OLYMPUS HONG KONG AND CHINA LIMITED**

Digital Camera Repair Centre

L4207, Office Tower, Langham Place, 8 Argyle Street, Mongkok, Kowloon, Hong Kong

Customer Hotline: +852-2376-2150 Fax: +852-2375-0630

E-mail: [cs.ohc@olympus-ap.com](mailto:cs.ohc@olympus-ap.com)

<http://www.olympus.com.hk>