

BOTC

Shower caddy INSTRUCTION MANUAL

PACKAGE CONTENTS

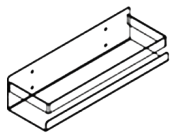

A-Shower Rack
(2pcs)



B-Hanging Strip
(4pcs)



C-Suction Cups
(4pcs)

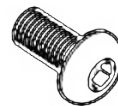

D-Screw
(8pcs)

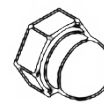

E-Screw
(8pcs)

ASSEMBLY INSTRUCTIONS

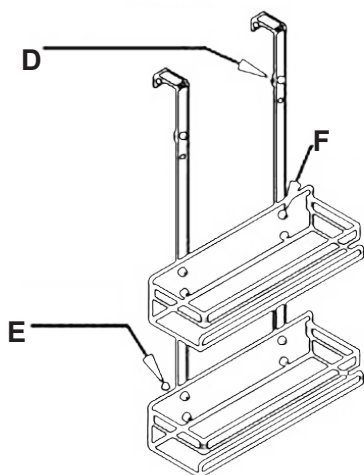

Step 3: Screw the hanging strips (B) on the available screw hole of the first shower rack (A)

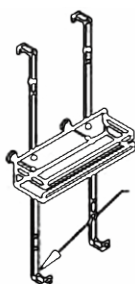

Note: The direction of the hook

Step 1: Attach the suction cup (C) to the hanging strip (B)

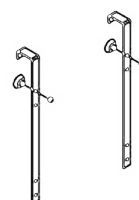

Step 2: Attach the shower rack (A) on the hanging strips (B) with screws (D) and nuts (E)

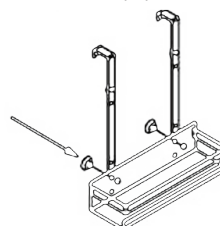

Step 4: Screw the second shower rack (A) on the hanging strips (B) with the screws (D) and nuts (E) and attach the last suction cup (C)

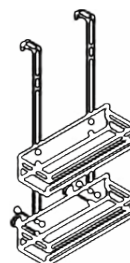

CONTACT US



Imported by UNI PHOENIX B



Infobotc001@gmail.com



De werf 1,2544 EH Den haag. Netherlands