

**LEGO**

# JUNIORS

10675



1



2



3



4



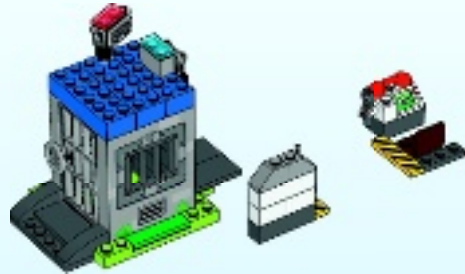
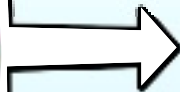
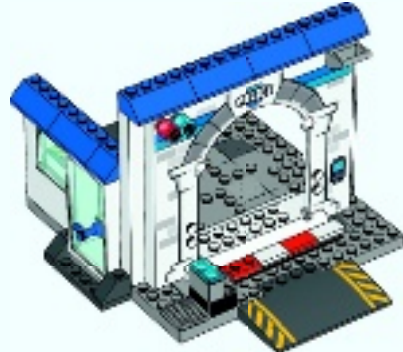

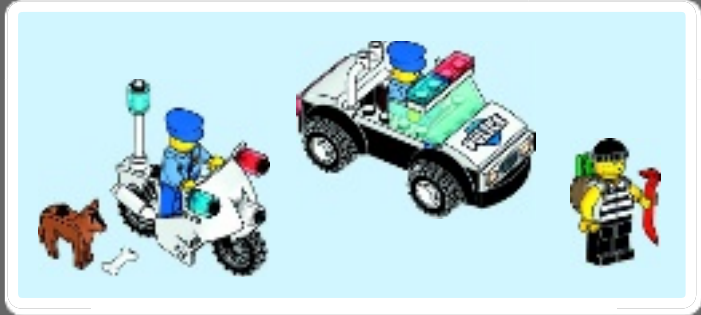



- 1x
- 2x
- 2x
- 1x
- 1x
- 1x
- 1x
- 1x
- 1x
- 1x
- 2x
- 1x
- 2x
- 1x





1x



2x



1x



2x



1

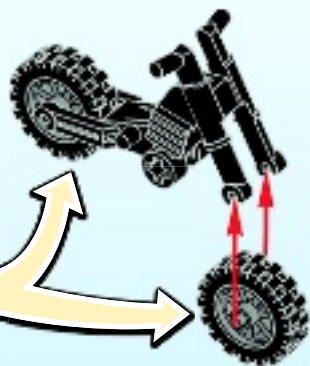

2x

2





1x



1x



2x



1x

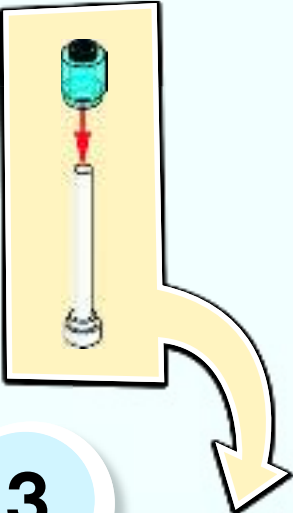

3

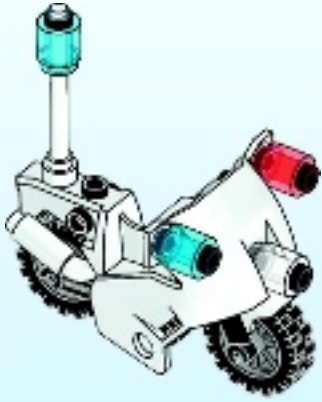

4





4x



4x



1x

1

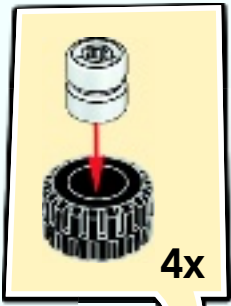

4x

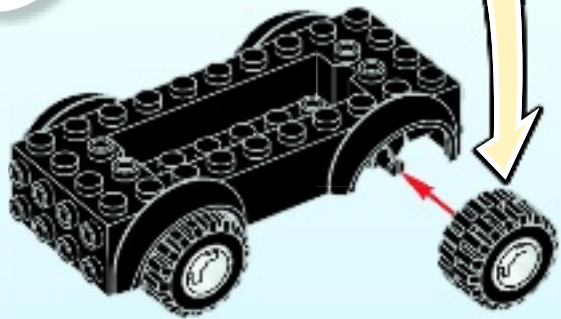





1x



1x



1x

2



3

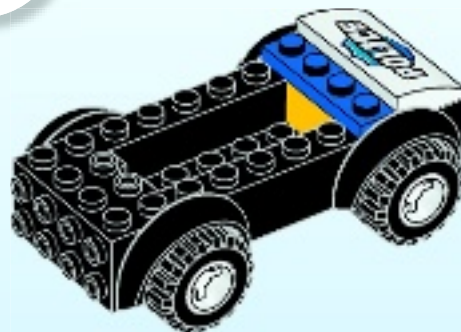



1x



2x



1x



4

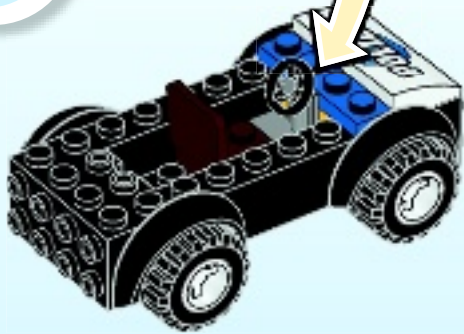

5

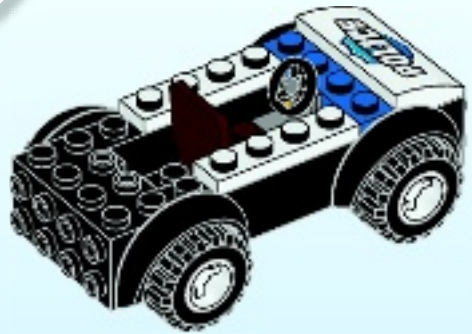



2x



1x



1x



1x

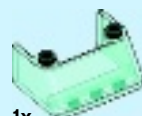

1x

6

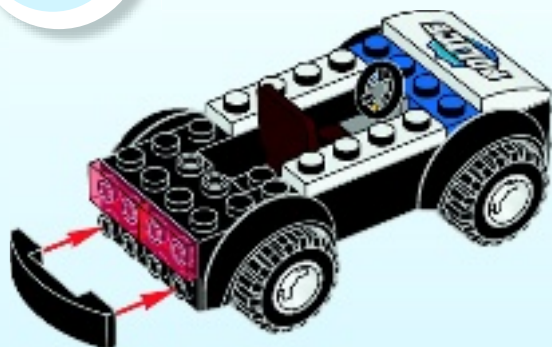

7

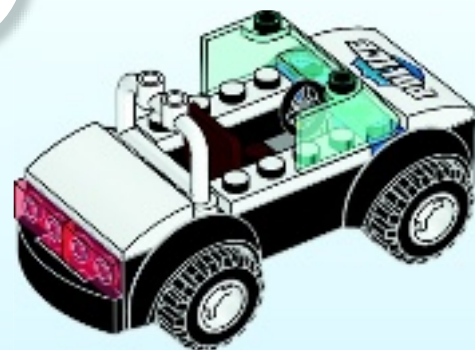



1x



1x



1x

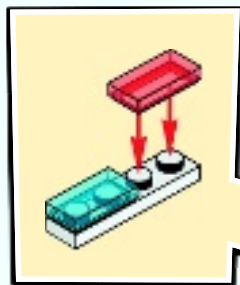

8

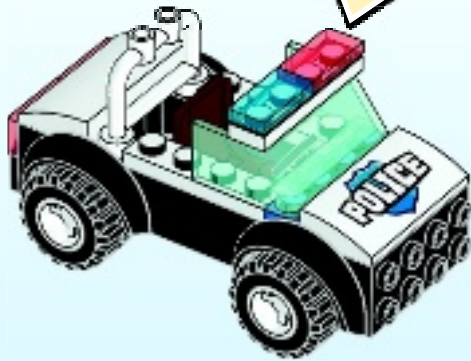



9

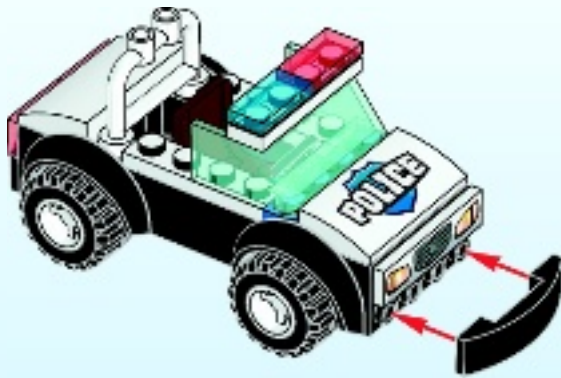

10

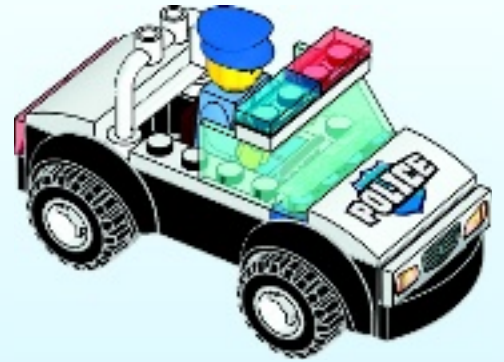

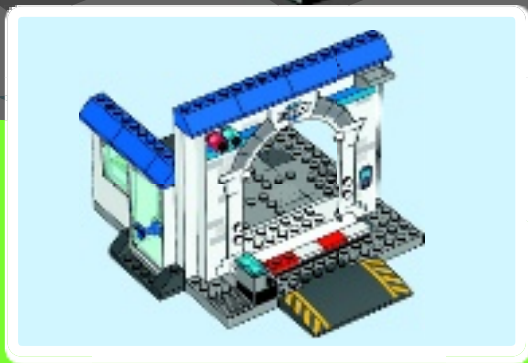

1

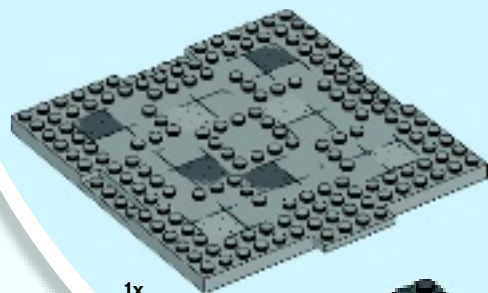

1x

1x

1x

2

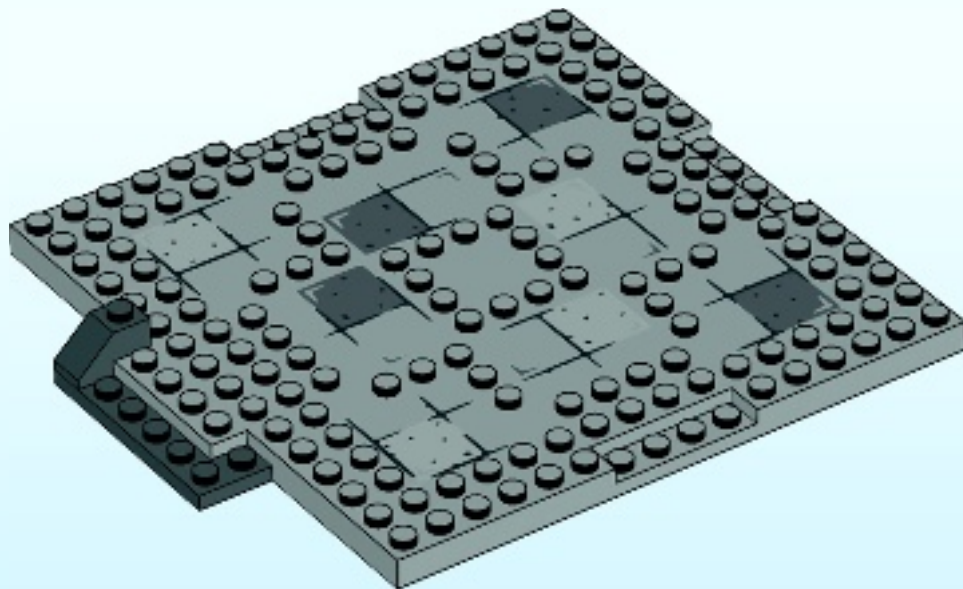



1x



2x



3

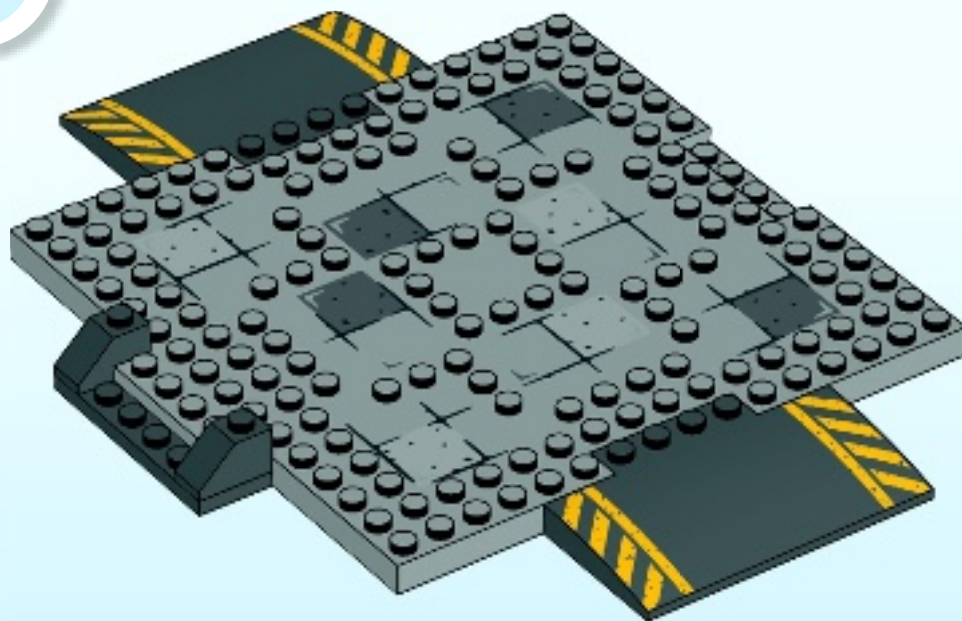



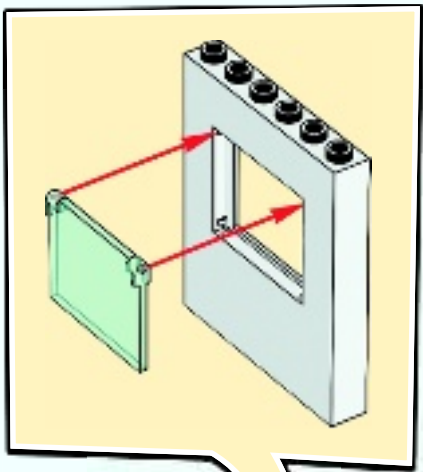

1x

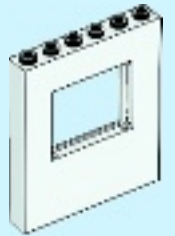

1x

4

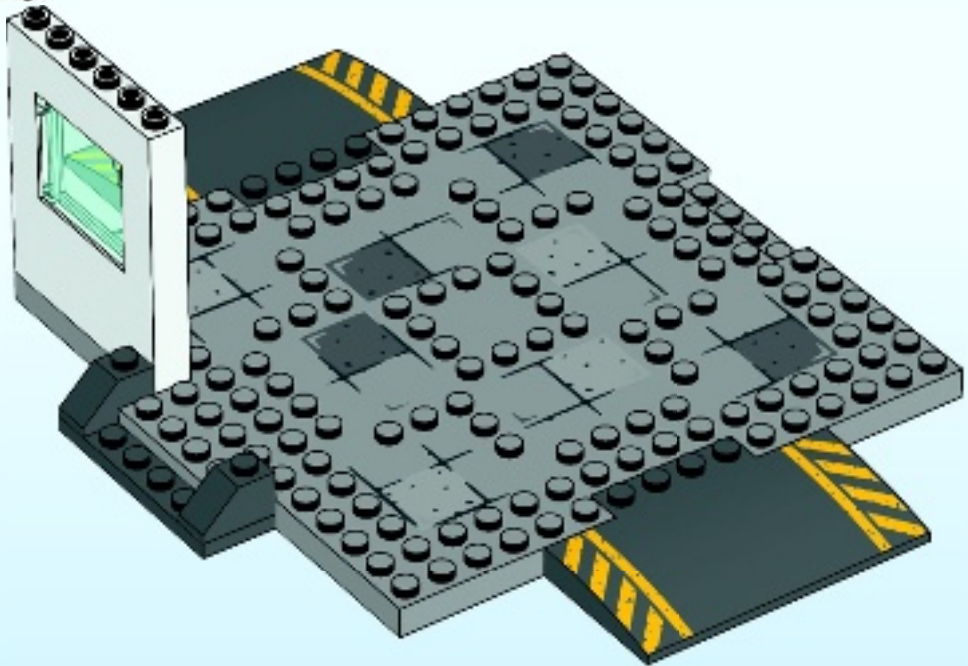

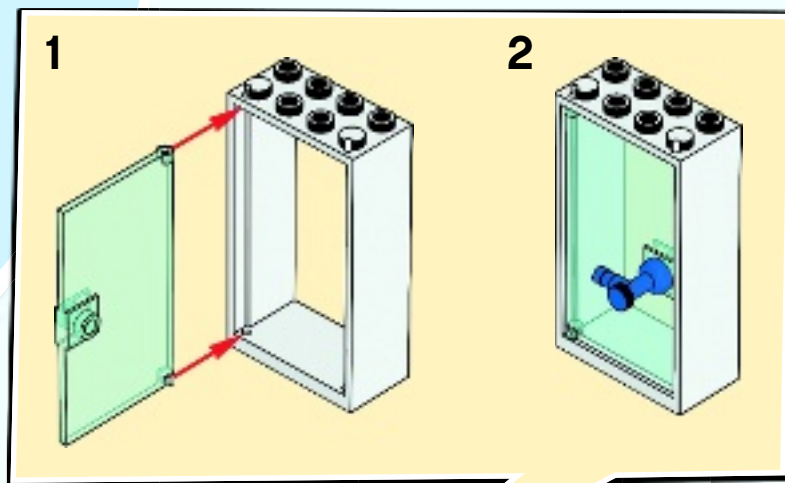
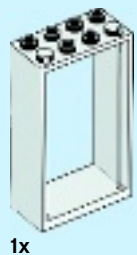

5

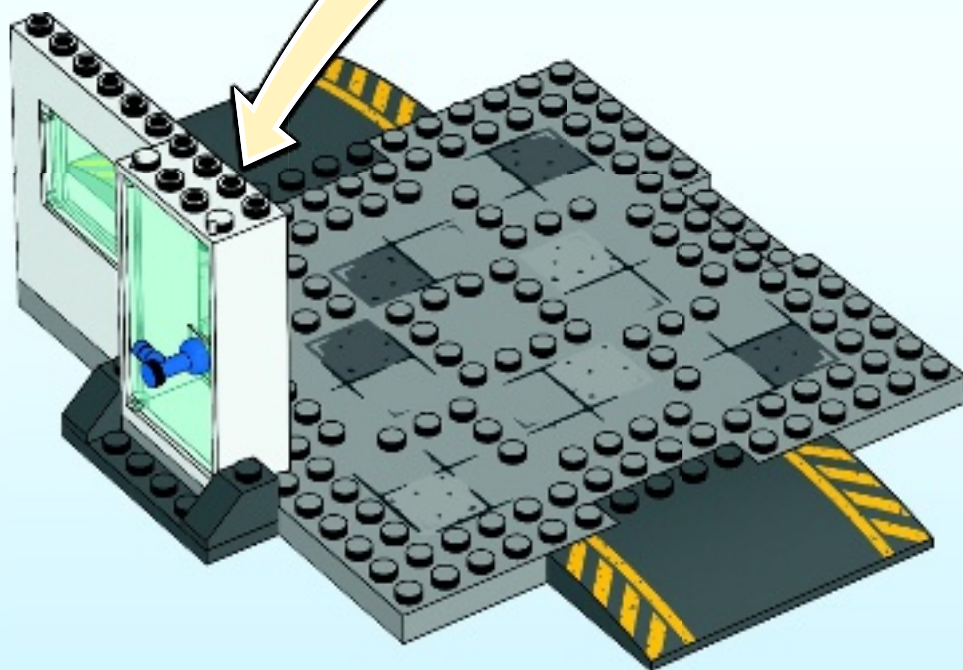



1x



2x

6

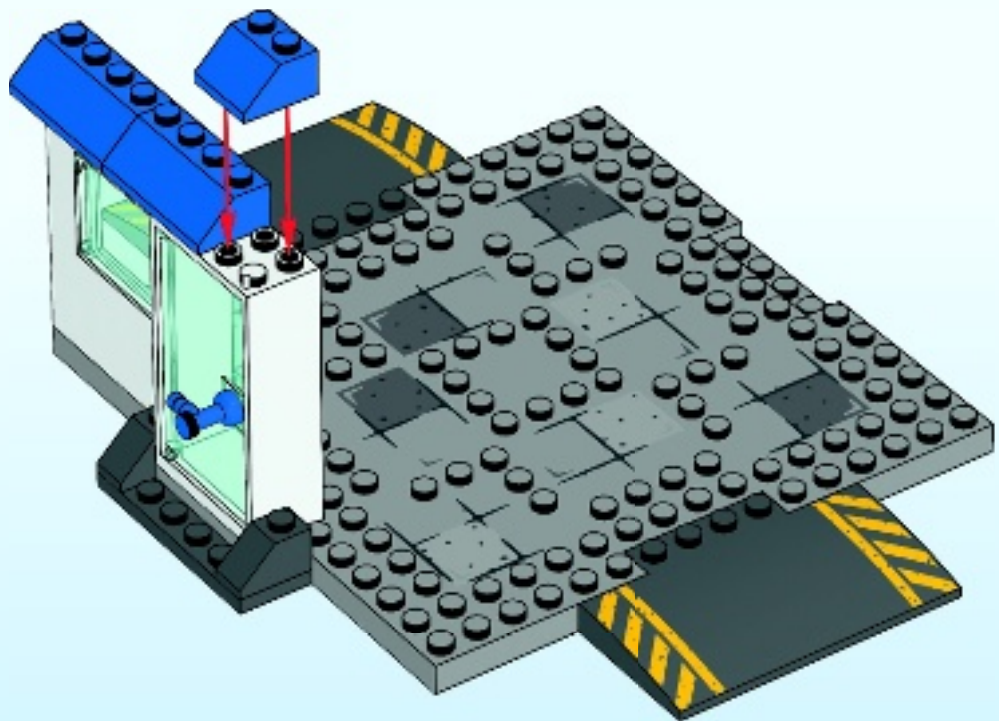

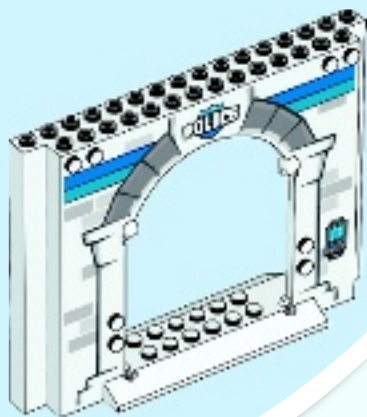

1x



2x

1x

7

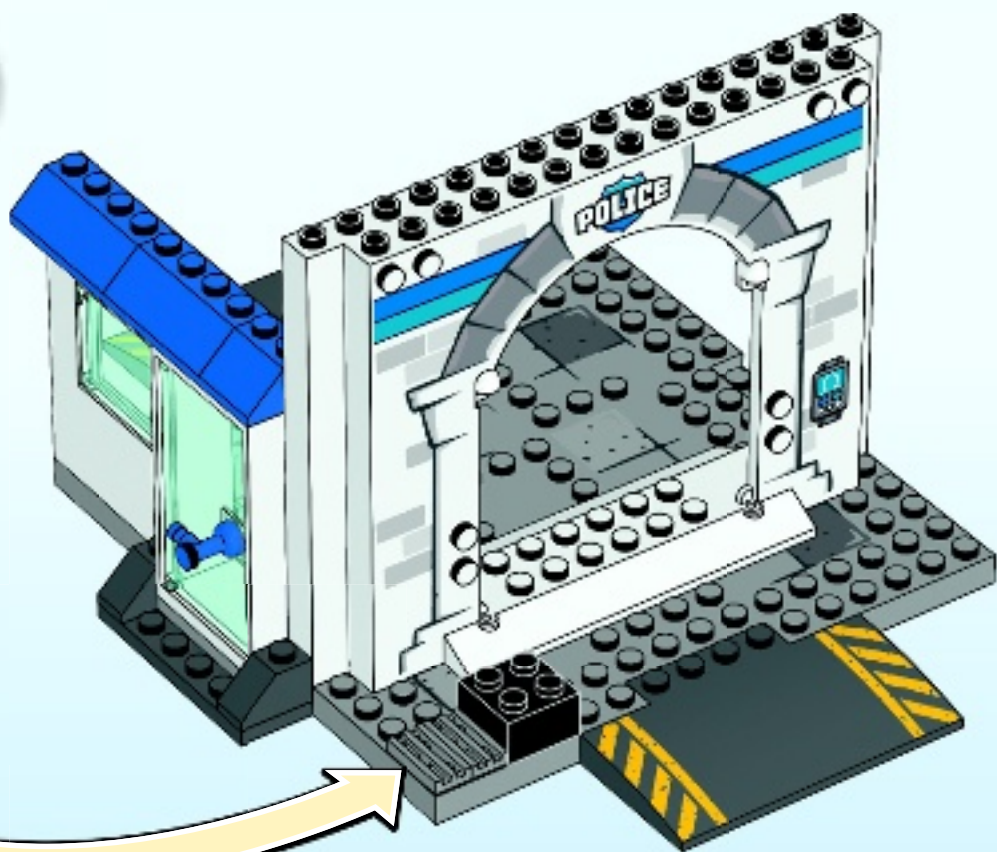

2x

8

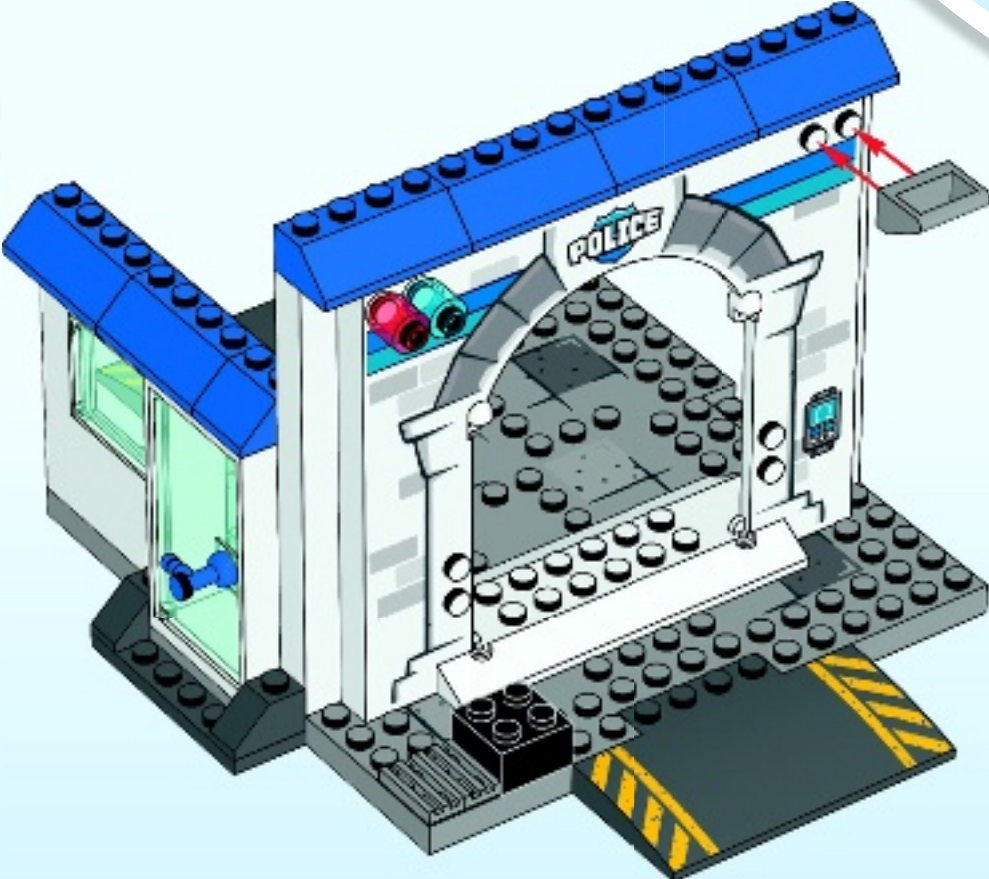

1x

1x

1x

4x

1x



2x



1x



1x



1x



1x

1

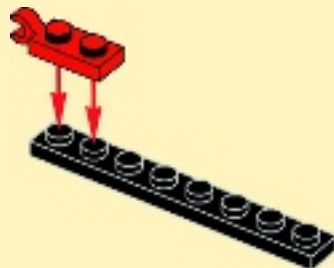

2

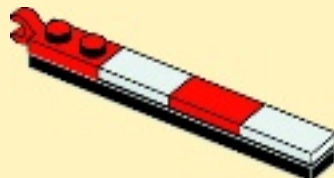

3

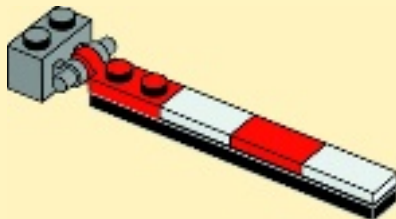

4

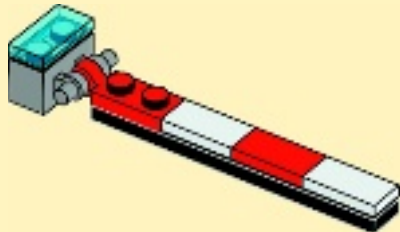

9

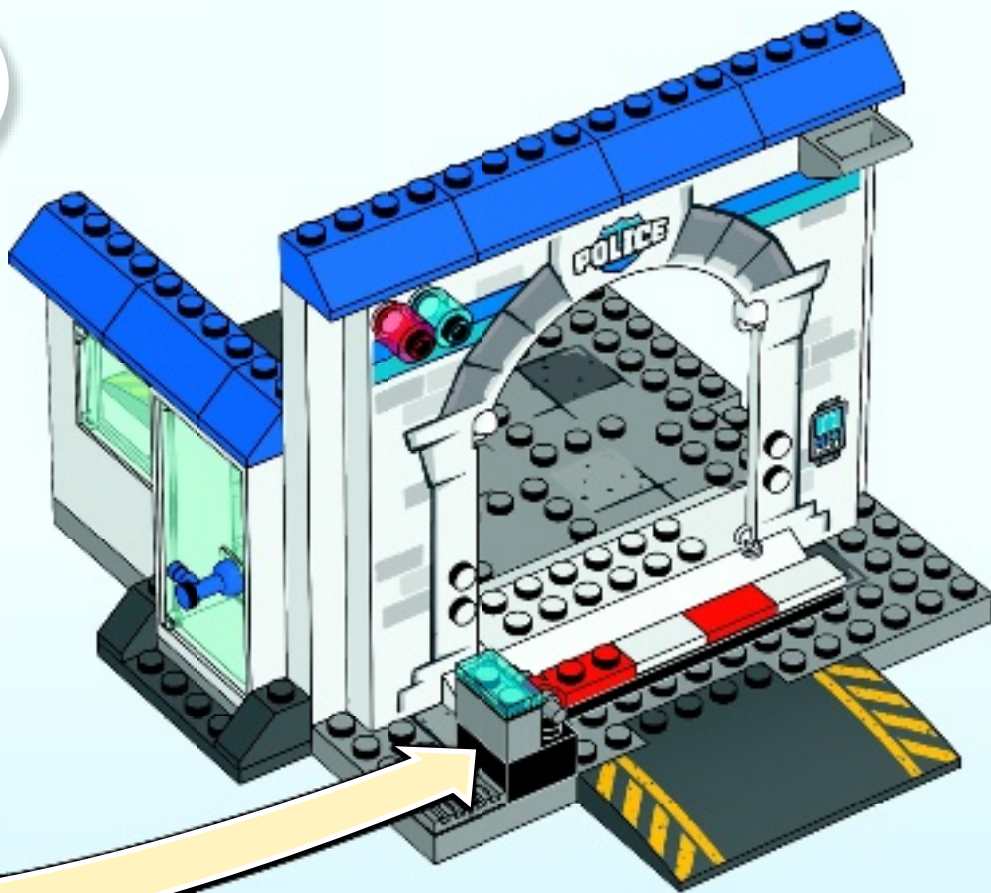



1x



1x



1x

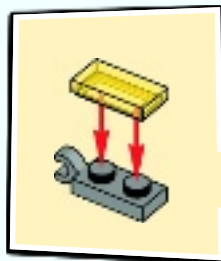

10

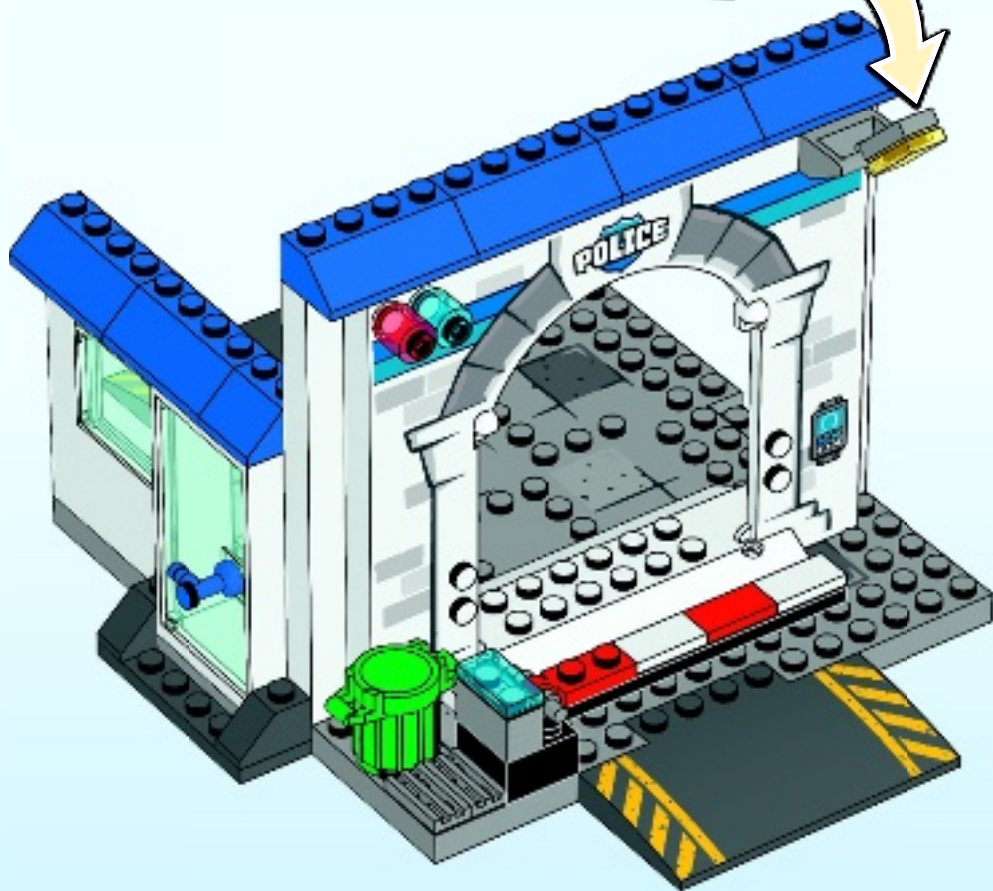



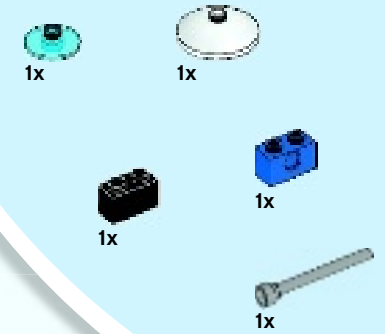
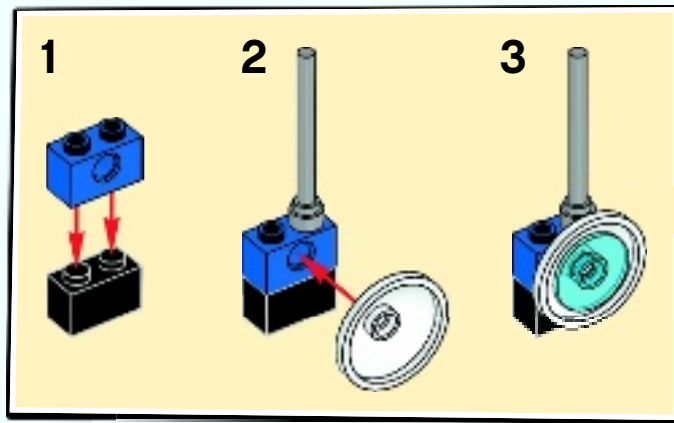

11

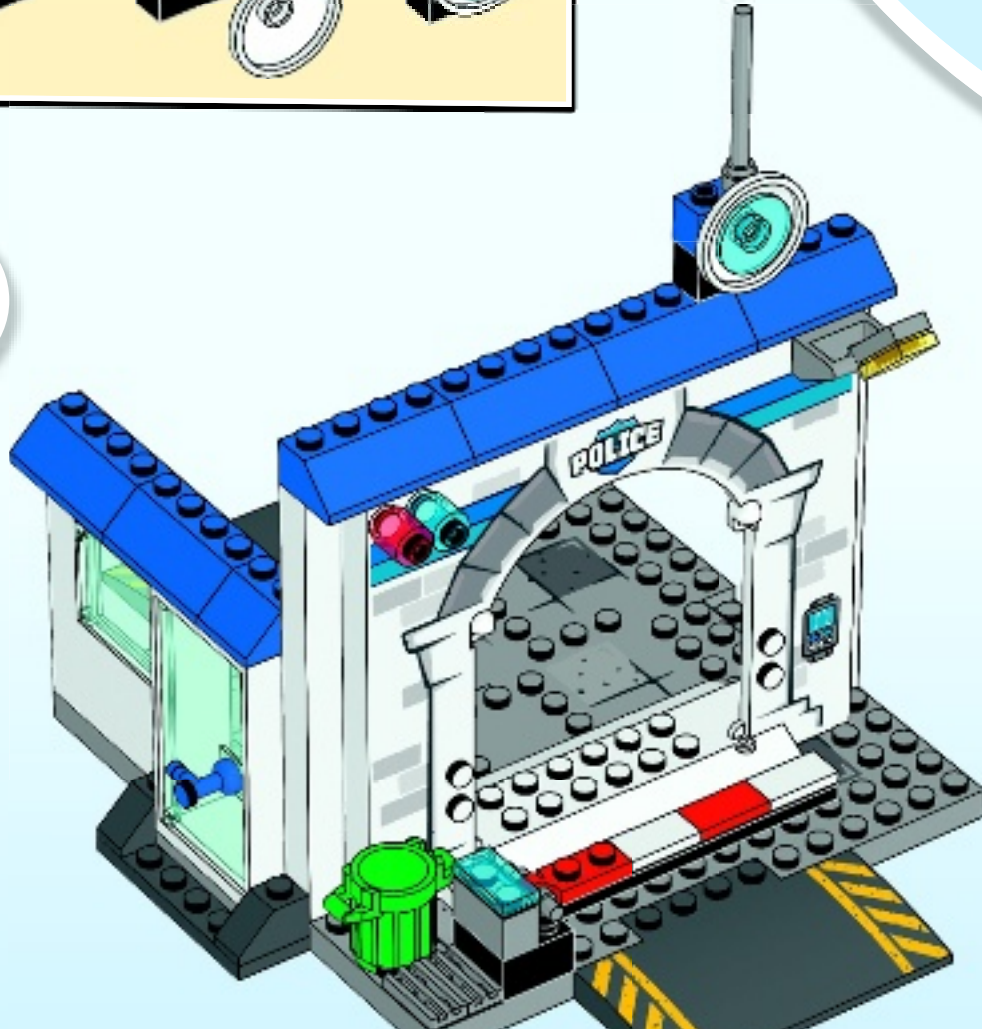

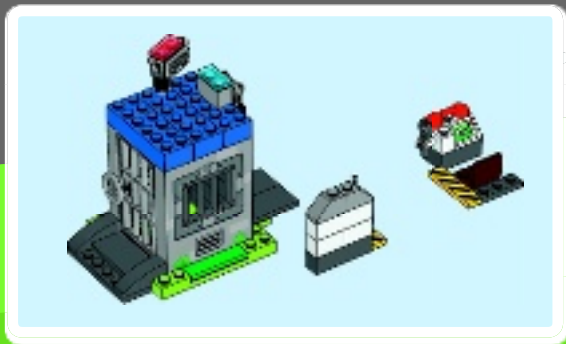
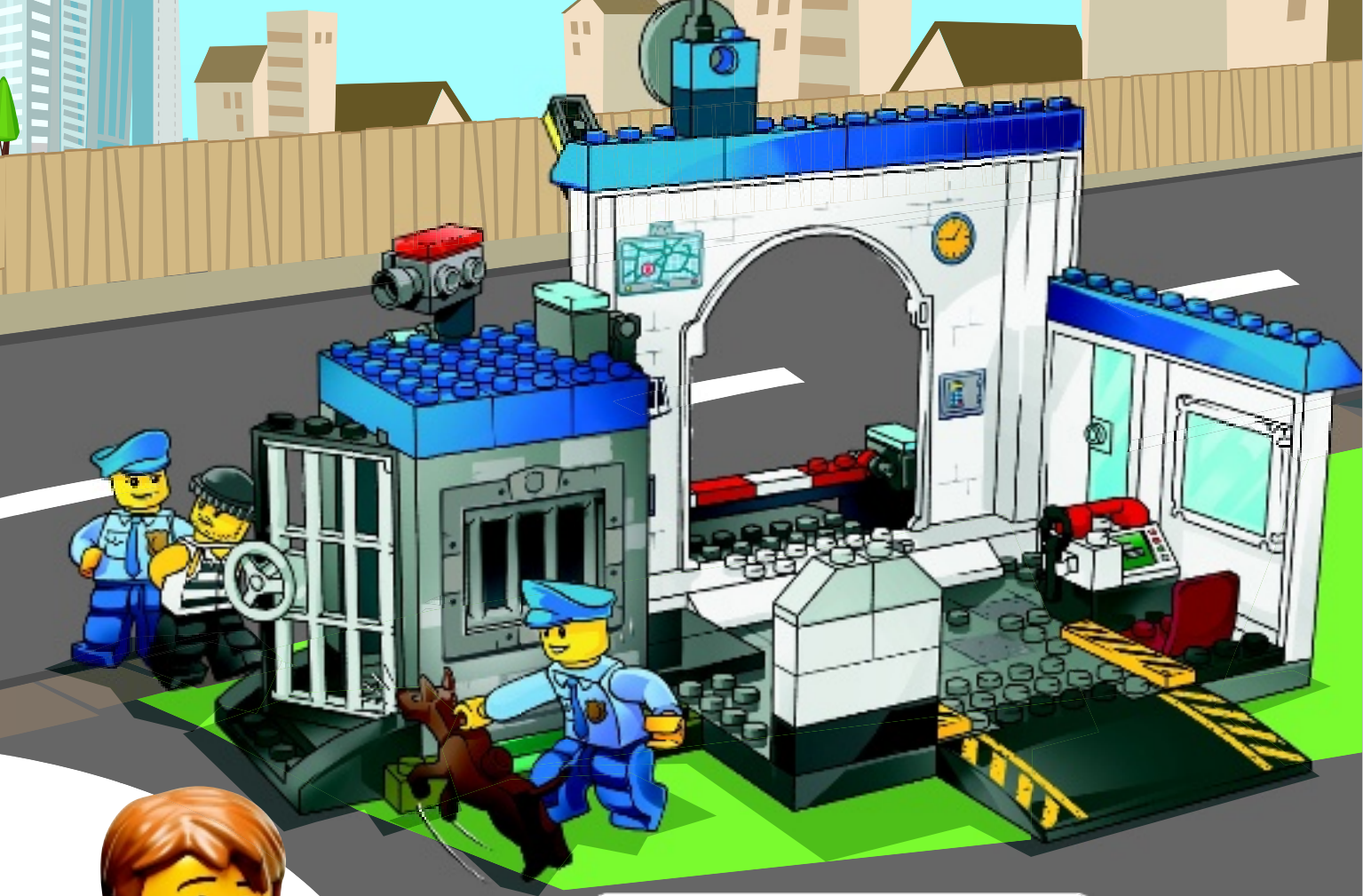

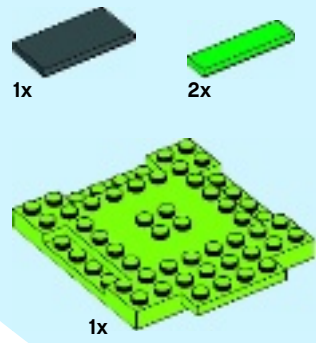

1

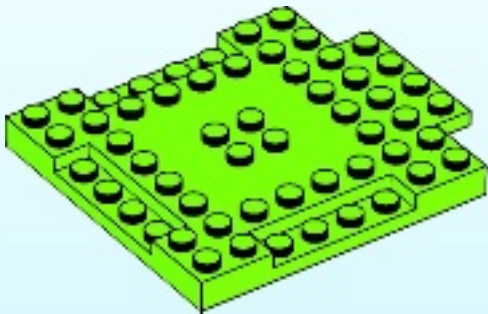

2

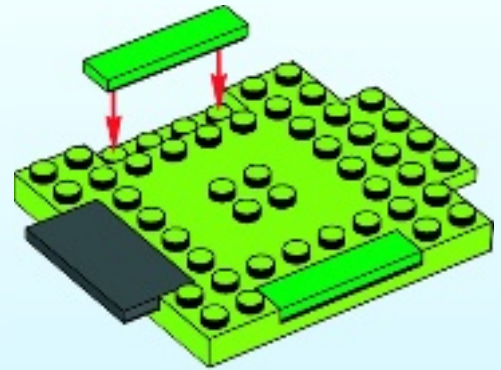



1x

3

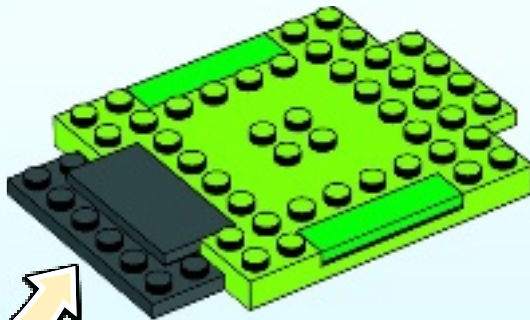



4

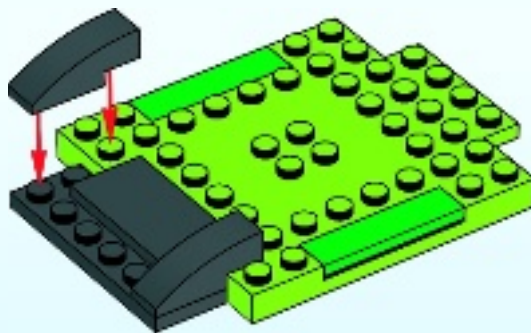



1x

1x

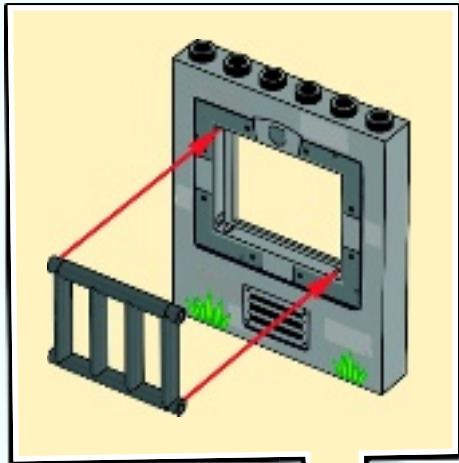

5

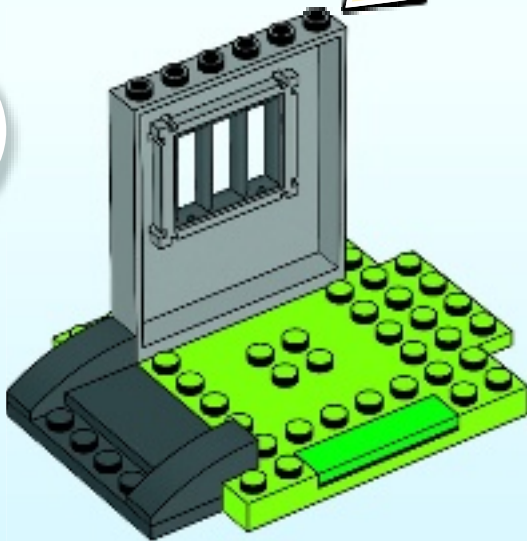

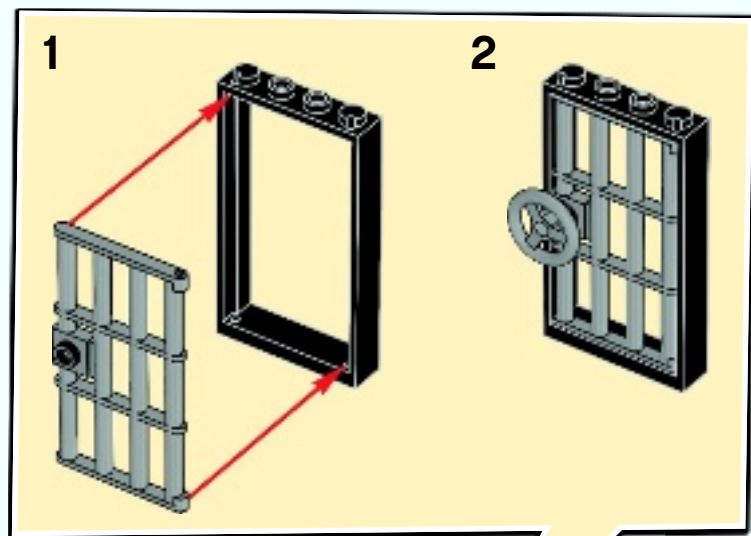

6

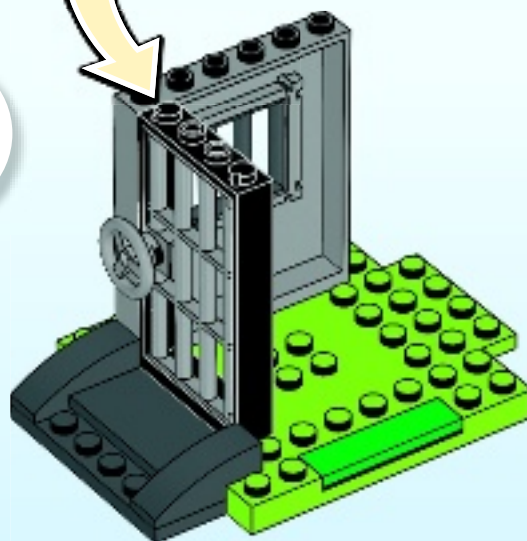



6x



7

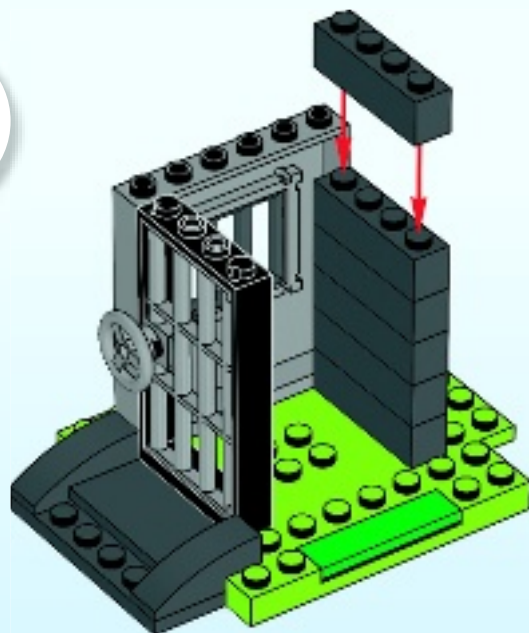



8

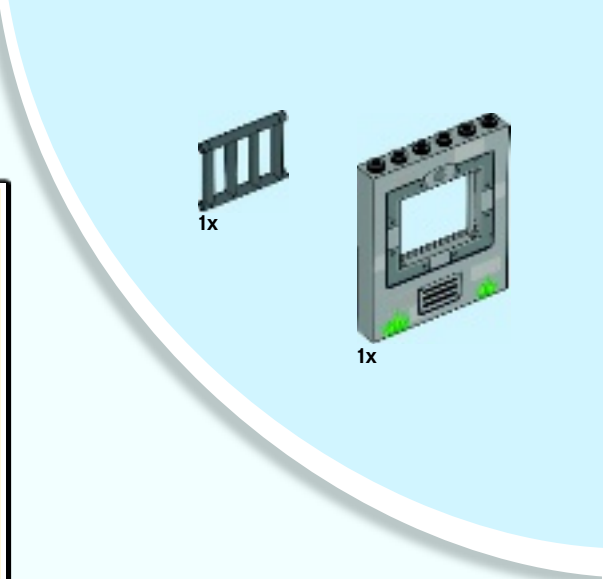
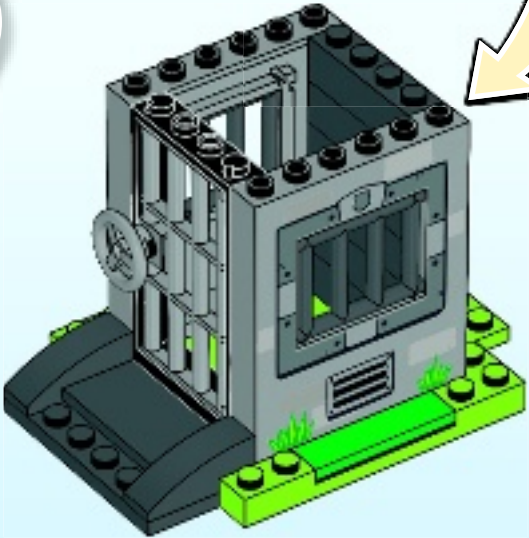
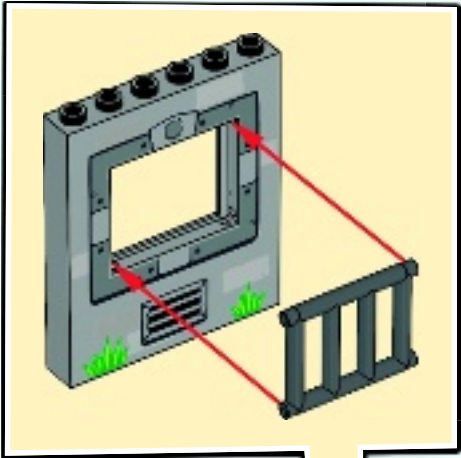

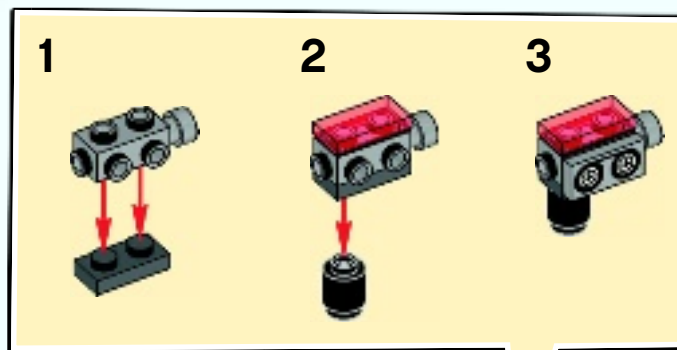
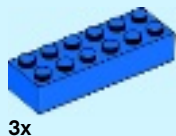
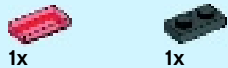
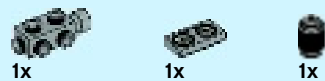

9

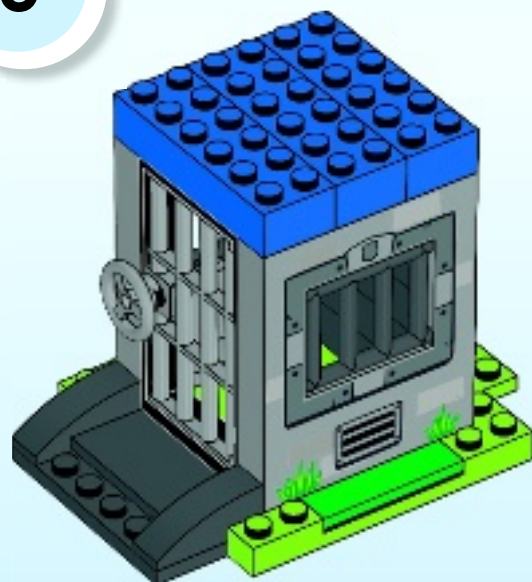

10

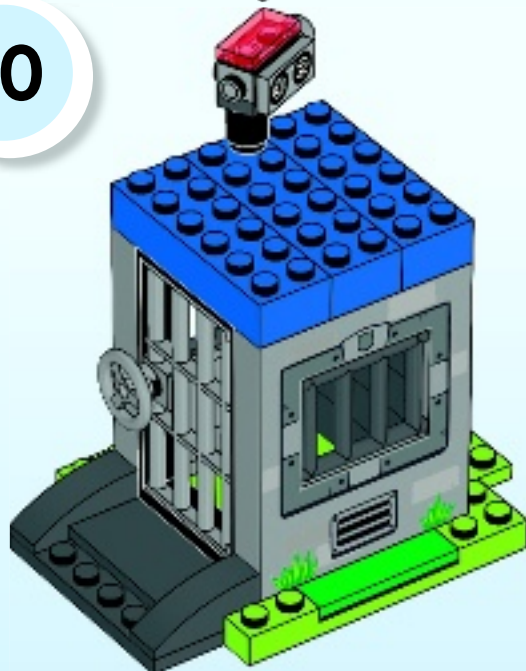

11

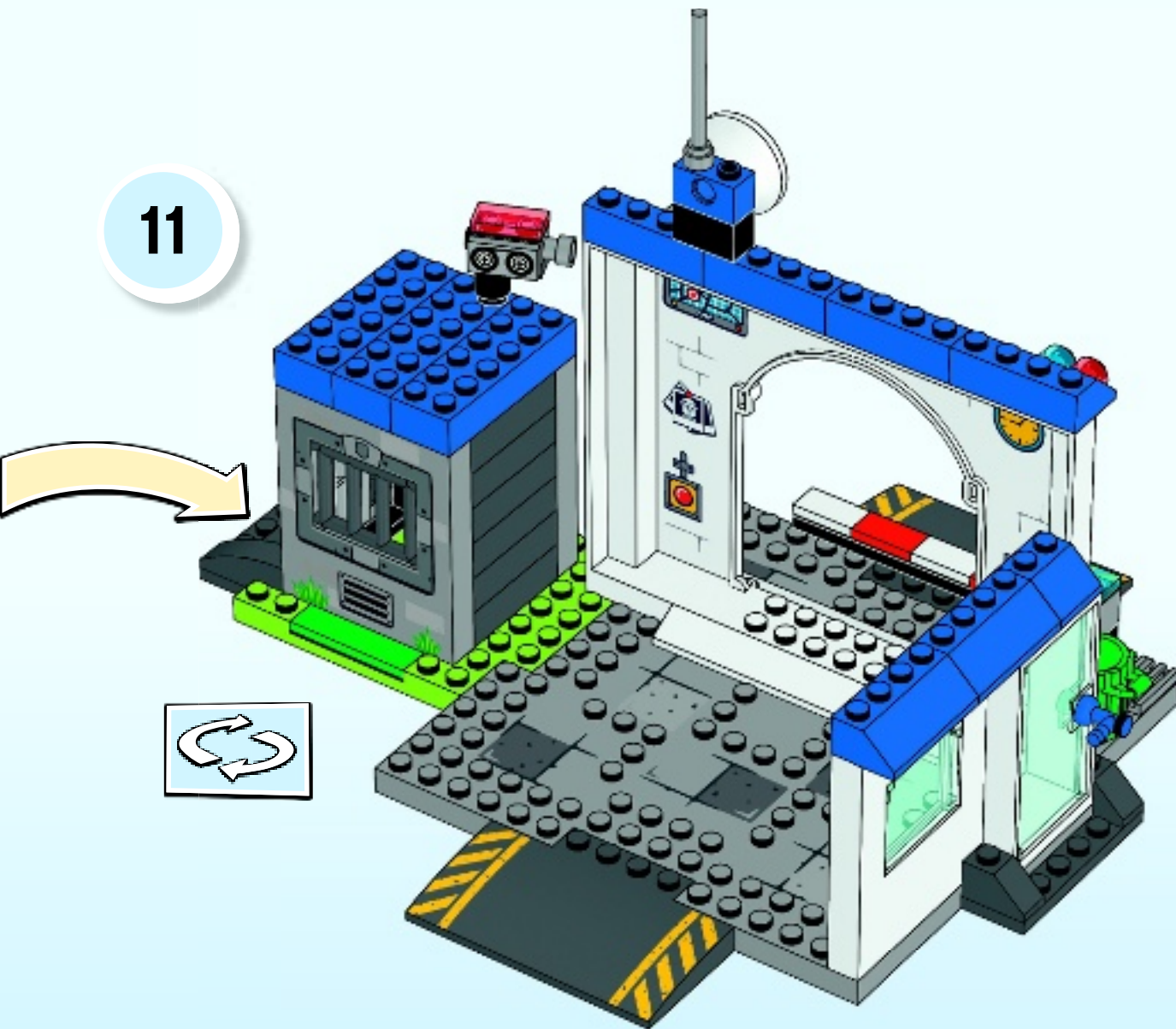



2x

12

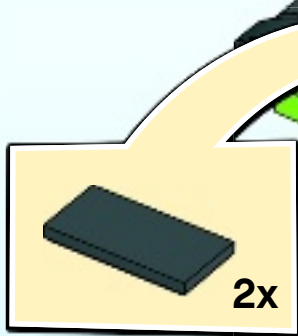

2x

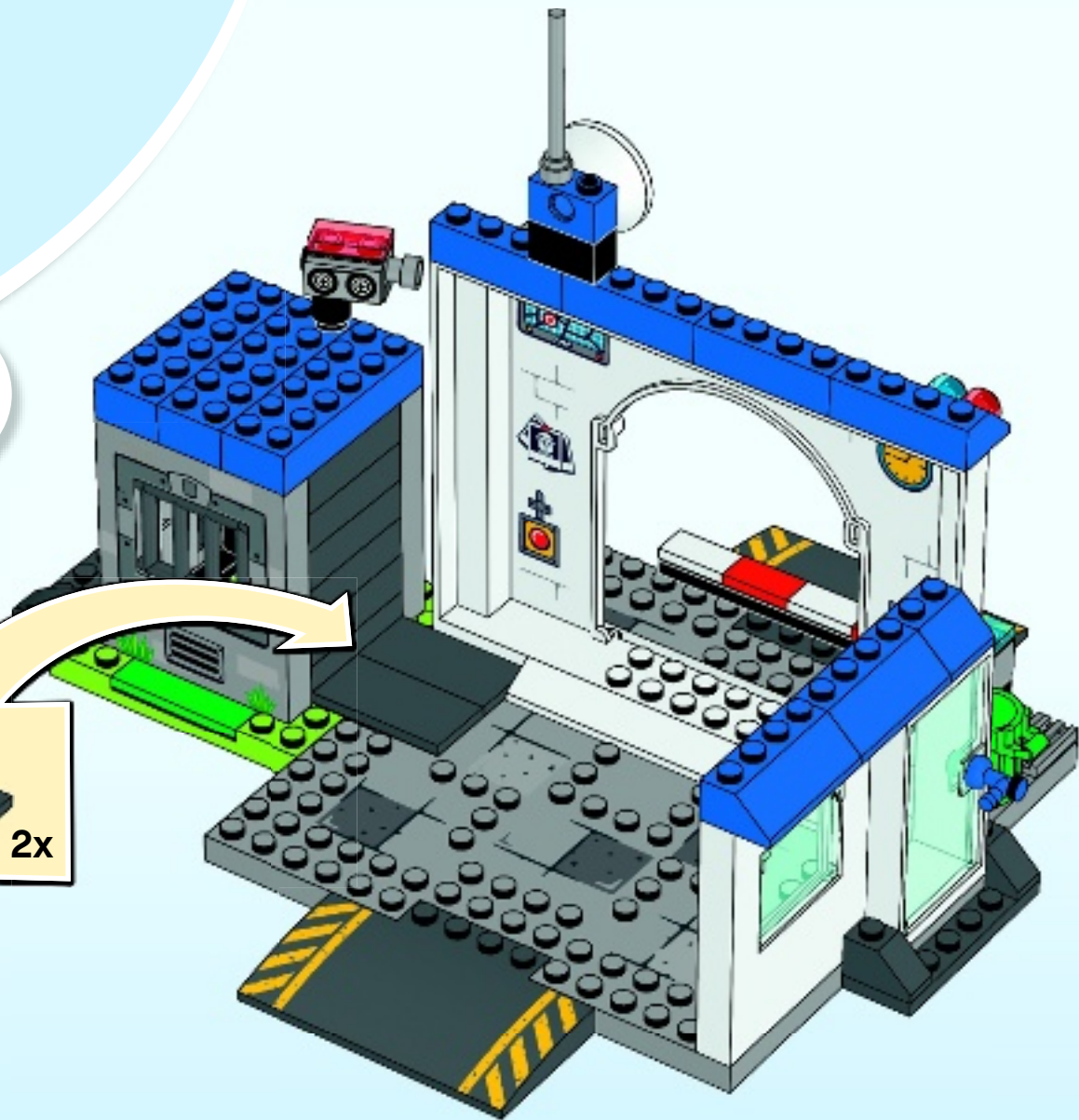

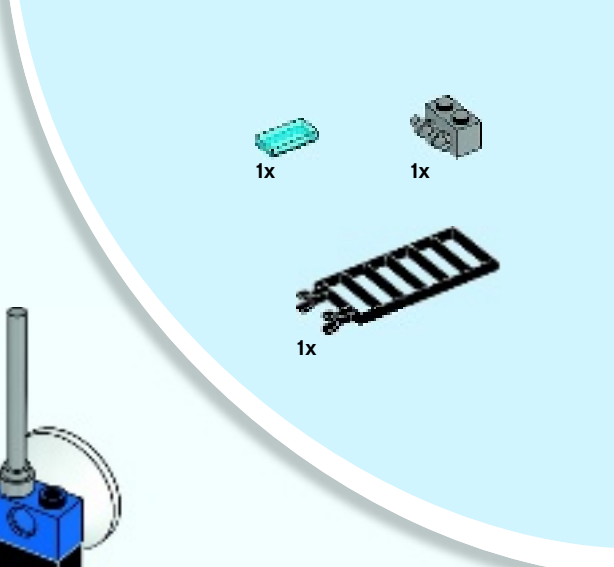
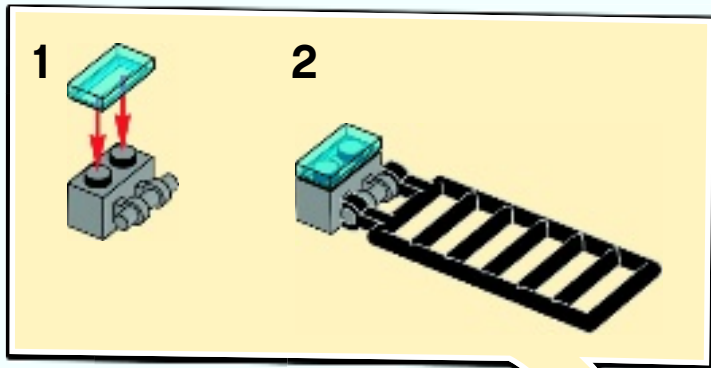

13

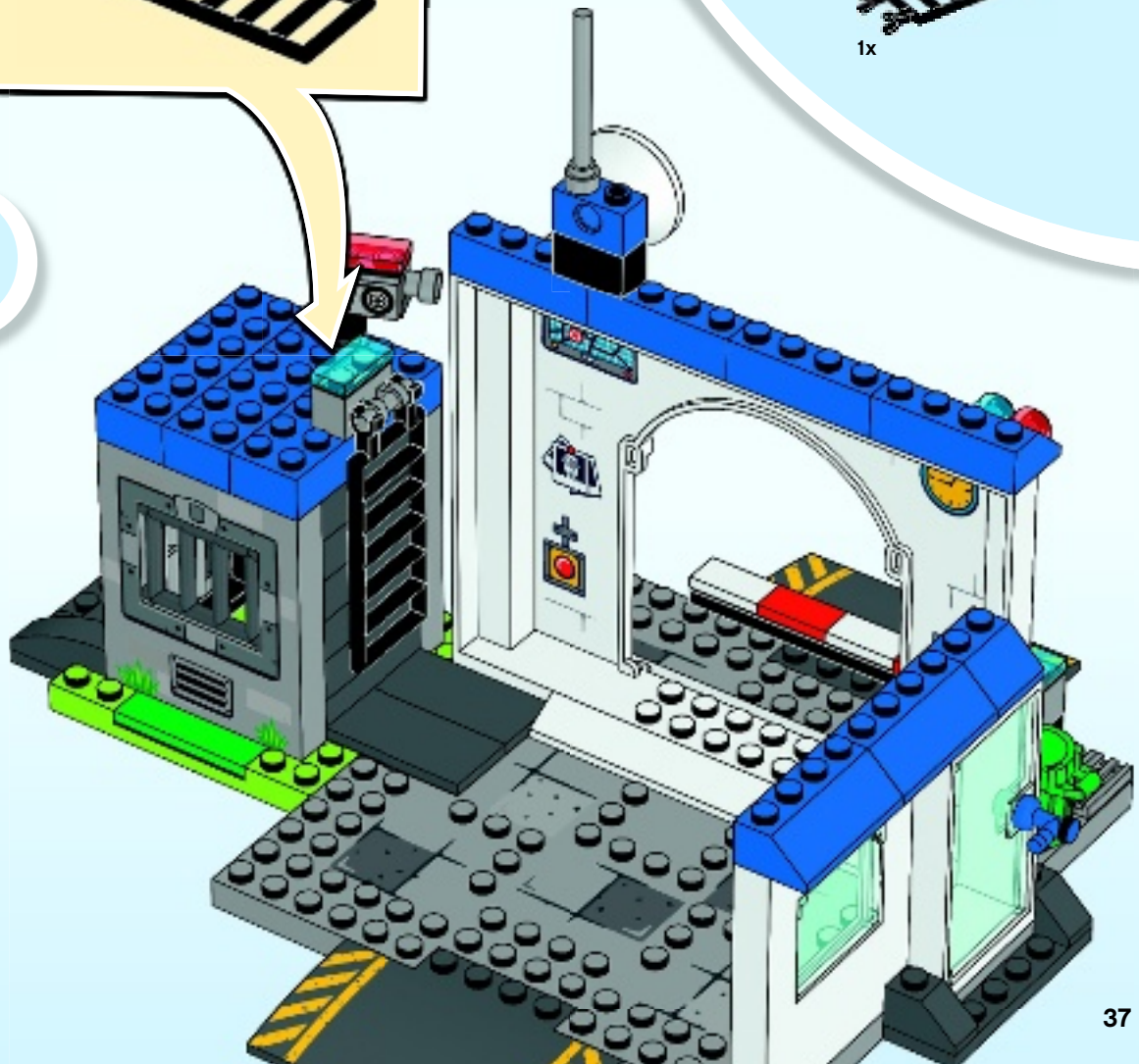



1x



2x

14

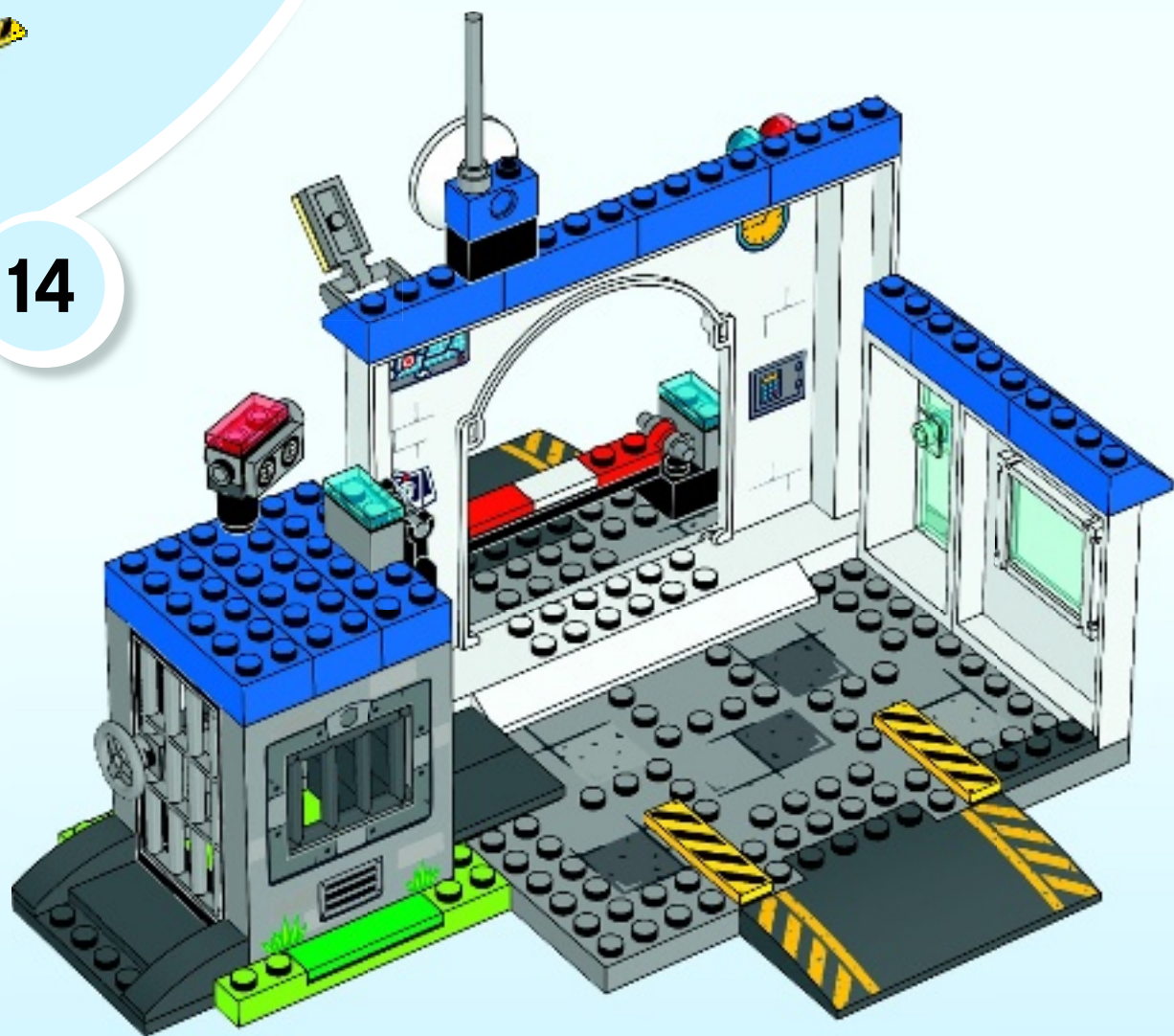

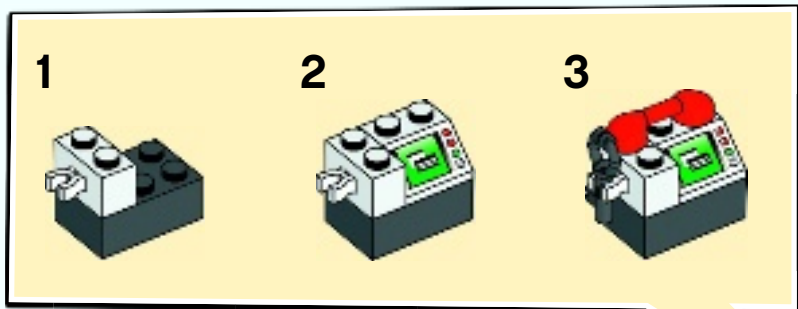

15

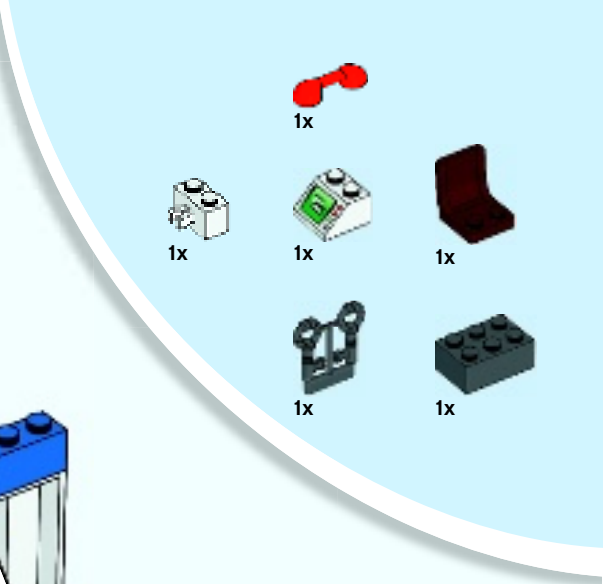
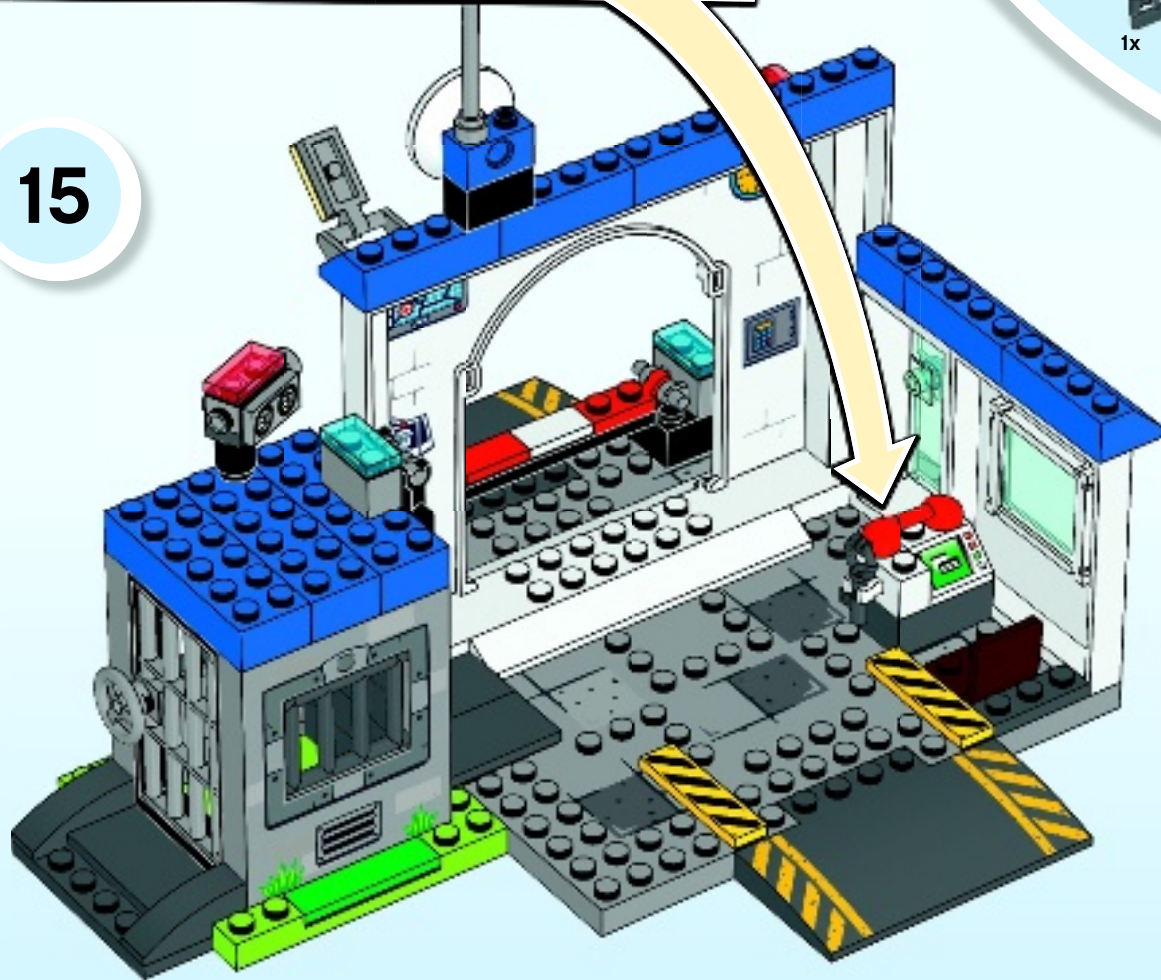



2x



1x



1x



1x



2x



1x

1

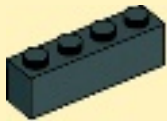

2

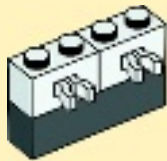

3

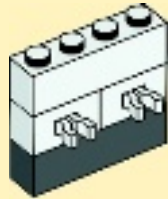

4





16

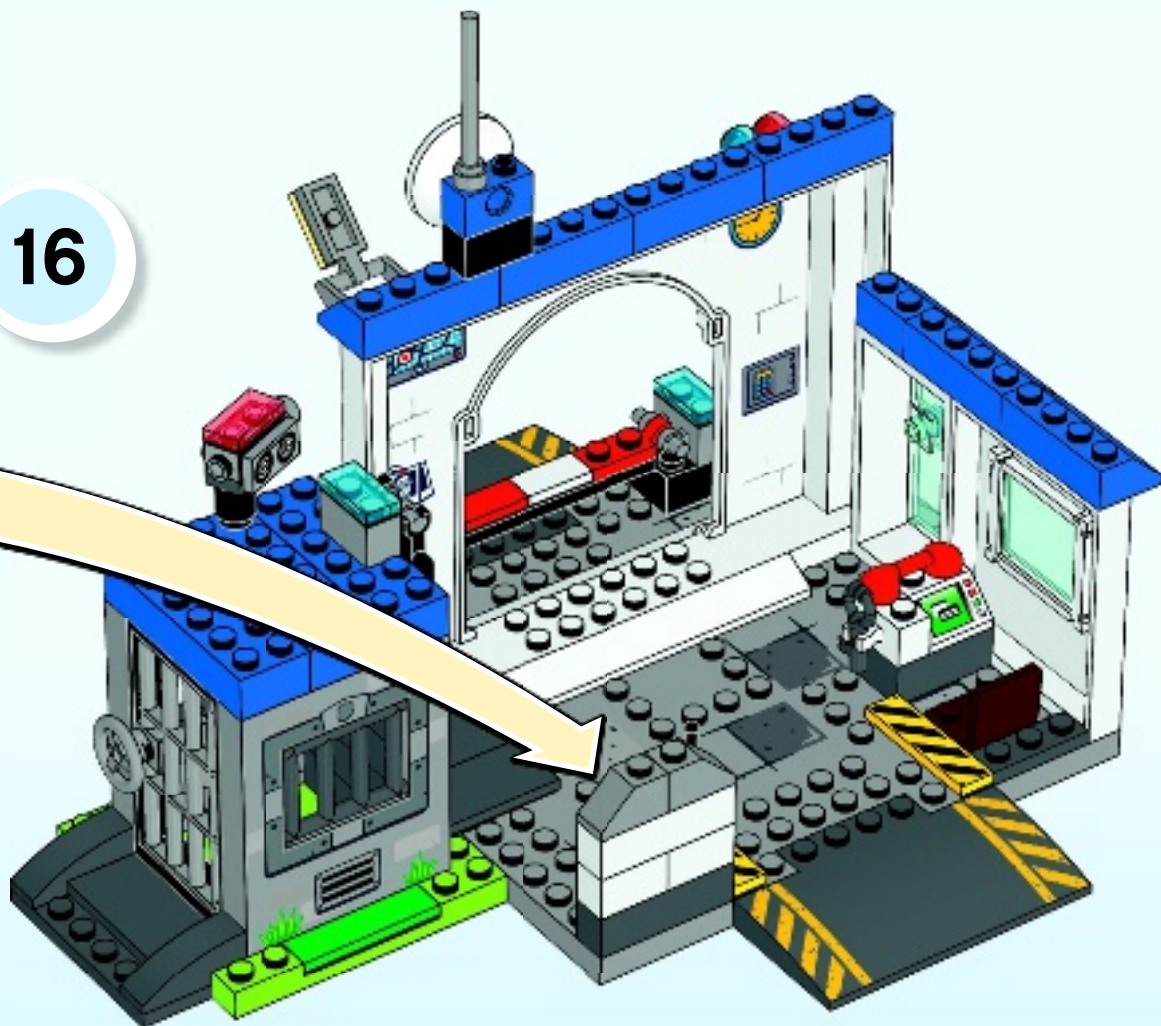

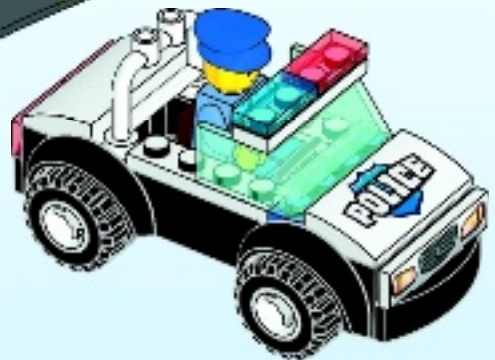
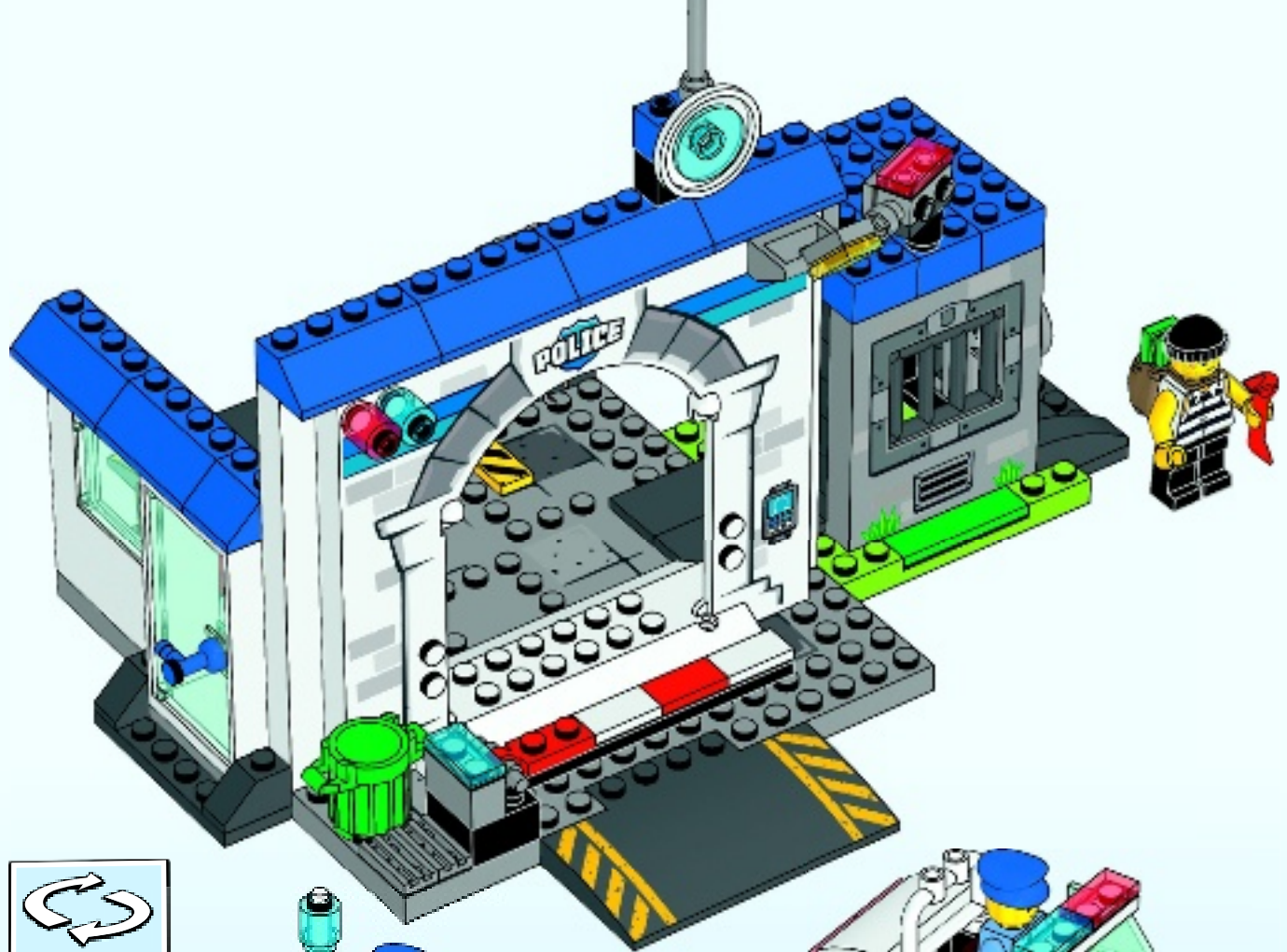



**LEGO.com/Juniors**



App



Games



Models



# JUNIORS



10674



10667



10673



10668



# Ready for **more?** build and play

- Bereit für mehr? Bauen und Spielen
- Encore plus de jeu ? construis et joue
- ¿Estás preparado? ¡Más construcción y más juegos!
- Estás pronto para mais? constrói e brinca
- Készen állsz MÉG TÖBB építésre és játékra?

**LEGO** CITY

5-12



**LEGO** JUNIORS

4-7



**THE CITY WITH ENDLESS POSSIBILITIES...**

[LEGO.COM/CITY](http://LEGO.COM/CITY)

1



2



2x  
6064174



4x  
4568644



1x  
4530673

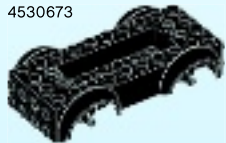

1x  
6025012



1x  
4157108



1x  
396226



1x  
9339



1x  
4535834



1x  
4654046



1x  
4535738



1x  
4211502



1x  
4641048



2x  
4590443



1x  
4211473



1x  
300426



1x  
300326



1x  
306226



2x  
4613153



1x  
346026



1x  
602026



2x  
4211580



2x  
4211614



2x  
4211350



1x  
4211701



1x  
4226995



1x  
4211357



1x  
4610149

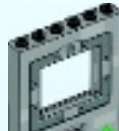

2x  
6059076

1x  
6059168



1x  
4506998



1x  
4613418



1x  
4259916



1x  
300424



2x  
4119091



1x  
4626650



2x  
4295260



2x  
243128

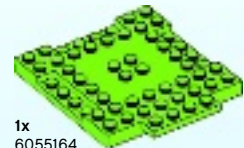

1x  
6055164



3x  
4117061



1x  
4651211



1x  
4583297



1x  
4287814



2x  
6023650



1x  
459923



1x  
4195657



2x  
306901



1x  
6058964



2x  
4521886



1x  
4614195



2x  
9341



1x  
6059255



1x  
4600294



3x  
3006843



1x  
4211105



1x  
3006840



2x  
4174743



3x  
371001



4x  
4170457



3x  
4113854



7x  
4211103



2x  
3006841



1x  
370023



1x  
301001



1x  
4179580



1x  
3006343



2x  
4211135



4x  
4189801



1x  
303923



1x  
4528140



1x  
408301



1x  
4194535



2x  
4246896



1x  
4520866



6x  
4107437



1x  
6055192



1x  
395701



2x  
4211206



1x  
4211063



1x  
6013633



1x  
371023

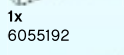

1x  
6058181



1x  
4579412



1x  
306921



1x  
4211133



1x  
4228126



3x  
4181139



1x  
4534648



3x  
4560184



1x  
4558598



2x  
4211002



1x  
4599453



1x  
4598955



2x  
6058098

Customer Service

Kundenservice

Service Consommateurs

Servicio Al Consumidor

LEGO.com/service or dial



: 00800 5346 5555

: 1-800-422-5346



# WIN!

Go to [LEGO.com/productfeedback](http://LEGO.com/productfeedback) to fill out a survey for a chance to win a cool LEGO® Product. No purchase necessary. Open to all residents where not prohibited.



## LEGO.com/productfeedback

### GEWINNE! WIN!

Nimm an der Umfrage auf [LEGO.com/productfeedback](http://LEGO.com/productfeedback) teil und hab die Chance ein cooles LEGO® Produkt zu gewinnen!

Die Teilnahme am Gewinnspiel führt zu keinerlei Kaufverpflichtungen. Teilnahme in allen nicht ausgeschlossenen Ländern möglich.

Ga naar [LEGO.com/productfeedback](http://LEGO.com/productfeedback), vul een enquêteformulier in en maak kans op een cool LEGO® product.

Geen aankoopverplichting. Ledereen mag deelnemen, uitgezonderd ingezetenden van landen waar een enquêteverbod geldt.

### GAGNE! 当てよう!

Visite [LEGO.com/productfeedback](http://LEGO.com/productfeedback) pour répondre à un questionnaire et avoir une chance de gagner un produit LEGO® très cool!

Aucune obligation d'achat. Ouvert à tous les résidents des pays autorisés.

[LEGO.com/productfeedback](http://LEGO.com/productfeedback) にアクセスして、アンケートにご記入ください。当選者にはレゴ® 製品を差し上げます。

お買い上げの必要はありません

禁止されていない限り、すべての皆様にご利用いただけます。

