



JADUZZI FRANCE
5, Route de Paris
92 100 BOIS
COUSSY-LEZ-COIX

16

011116401



LIFT 1-2-3

HP

EN 14428

CA-IR-DA

E935 - A

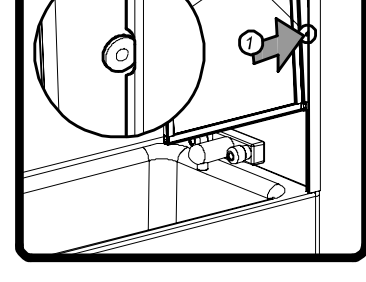
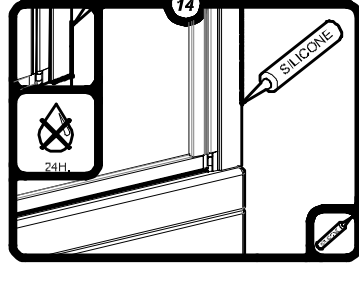
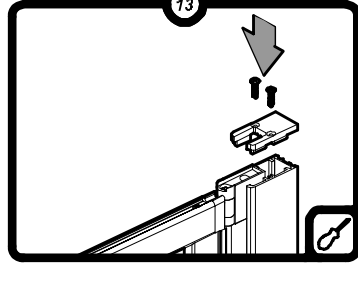
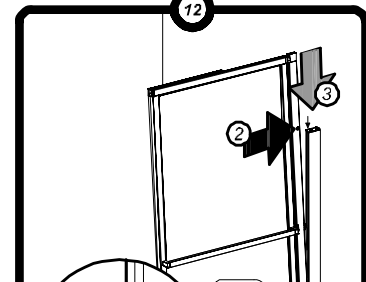
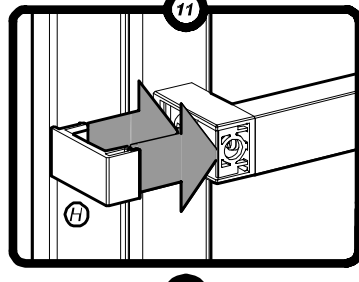
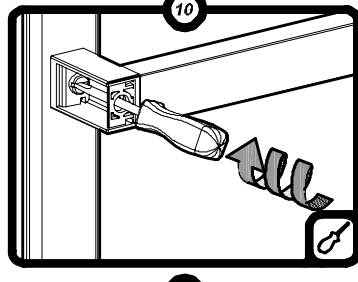
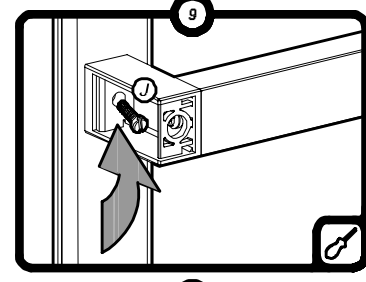
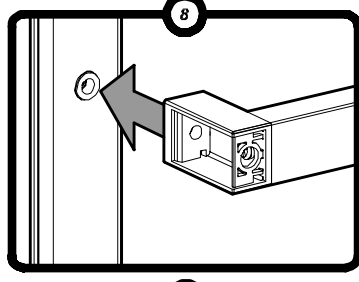
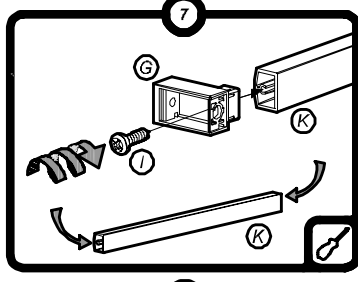
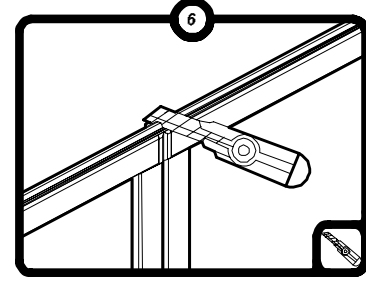
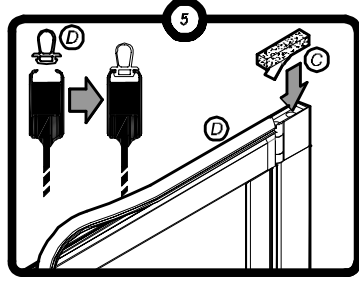
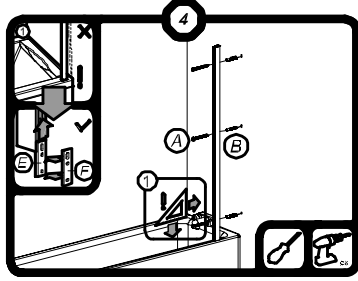
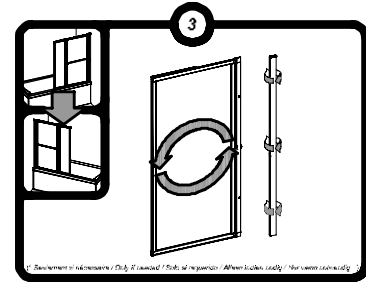
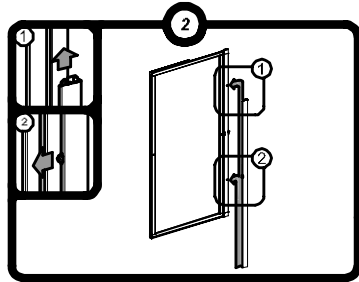
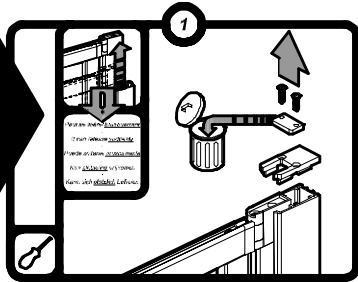
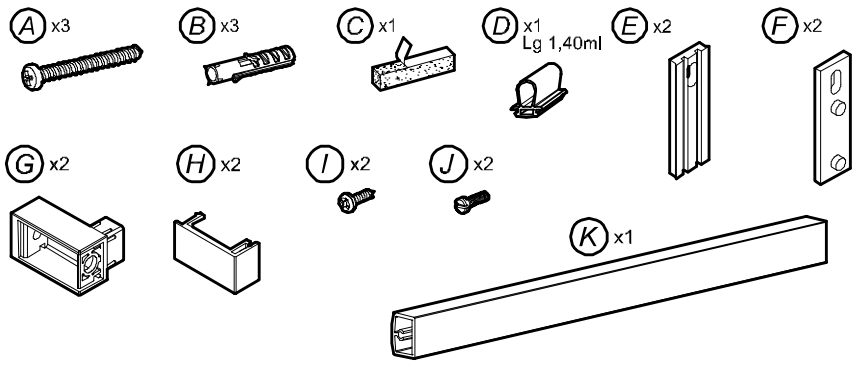
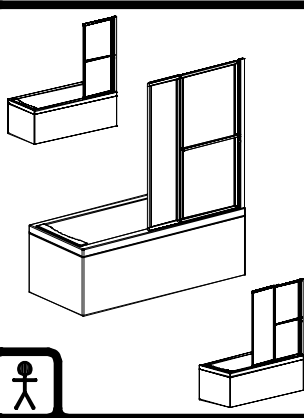

CAS DE POSE STANDARD

CAS DE POSE PARTICULIER

