

MIRI

Onderdelen Lijst

A 2STUKS

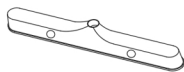

B 2STUKS



C 2STUKS



D 1STUK



E 1STUK



F 1STUK



G 4STUKS



H 2STUKS



I 1STUK

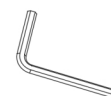

Stappen in elkaar zetten

1 Plaats de onderste horizontale stangen (B) in de gaten van de voetstukken (A)

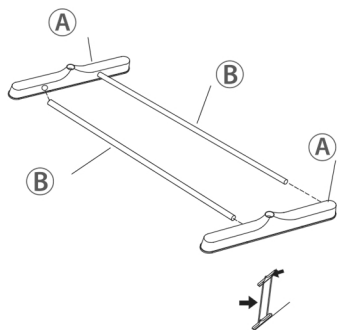

2 Duw de stang (C) in de gaten van de voetstukken (A). Zorg ervoor dat deze goed aangedruwd worden

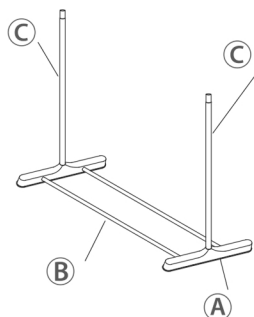

3 Plaats stang (D) en stang (E) in de stangen (C)

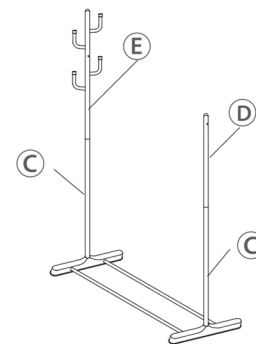

4 Schroef de schroeven om de hangende stang (F) te bevestigen. Gebruik de sleutel (I) om de schroeven stevig aan te draaien

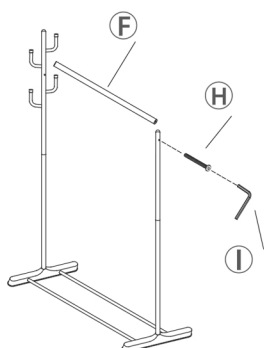

5 Druk vanuit de onderkant voorzichtig de wielen (G) in de voetstukken (A)

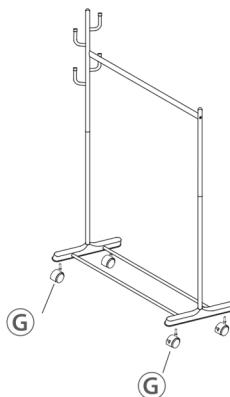

6 Gebruik de sleutel (I) nogmaals om te zorgen dat alles strak is aangedraaid

