

4202001008 V1.2

Motorbike/Bicycle Anti-Theft Alarm

Remote Alarm/Displacement Sensor Alarm

KS-SF22R

User Manual

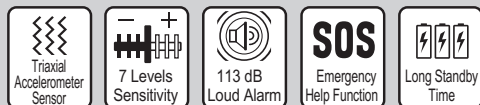

FCC ID: 2ANPS-KS-SF22R

This device complies with Part 15 of the FCC Rules. Operation is subject to the following two conditions:

(1) This device may not cause harmful interference, and (2) This device must accept any interference received, including interference that may cause undesired operation.

NOTE 1: This equipment has been tested and found to comply with the limits for a Class B digital device, pursuant to part 15 of the FCC Rules. These limits are designed to provide reasonable protection against harmful interference in a residential installation. This equipment generates, uses and can radiate radio frequency energy and, if not installed and used in accordance with the instructions, may cause harmful interference to radio communications. However, there is no guarantee that interference will not occur in a particular installation. If this equipment does cause harmful interference to radio or television reception, which can be determined by turning the equipment off and on, the user is encouraged to try to correct the interference by one or more of the following measures:

- Reorient or relocate the receiving antenna.
- Increase the separation between the equipment and receiver.
- Connect the equipment into an outlet on a circuit different from that to which the receiver is connected.
- Consult the dealer or an experienced radio/TV technician for help.

NOTE 2: Any changes or modifications to this unit not expressly approved by the party responsible for compliance could void the user's authority to operate the equipment.

- External: Domineering power with tiger form styling and acts a safeguard device to motorbike or bicycle.
- Similar performance to motorbike alarm, 113dB loud speaker although install at a hiding place to frighten the thief/robber.
- Use triaxial accelerometer sensor and special calculation to increase accuracy of robber manner recognition and reduce false alarms caused by noise interference.
- High efficient with 7 adjustable level of sensitivity, from soft touch to push beat and suitable for all conditions.
- 3 ringtones for remote bell sound; long range remote and easy to search the motorbike/bicycle.
- Can trigger SOS function and emit call for help automatically when an accident is occurred to provide more safeguard manner.
- Wireless remote operation; more simple and convenient to use.
- External Cover : PC material; IP65 water & dust proof
- Double-sided tape installation method is convenient for all types of motorbikes and bicycles.

1. External Structure Figure

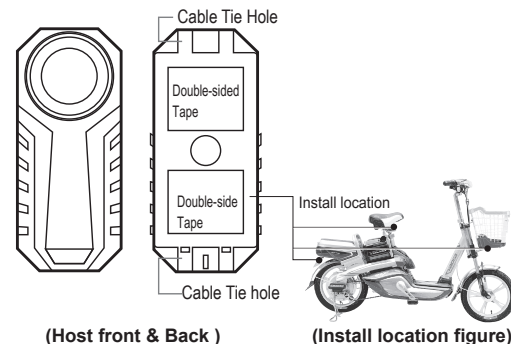

Cautions:

- Pay attention on host fixation method suitability, double-sided tape or cable tie when use it.
- Install at a hiding location may reduce host alarm sound level.
- Do not install the host at surrounded with metal parts location.

Remote control have two below types according to order package set

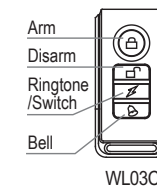

WL03C

Figure of bottom cover removal method:

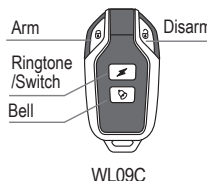
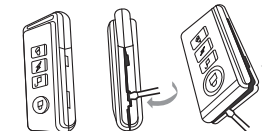

WL09C

Figure of bottom cover removal method:

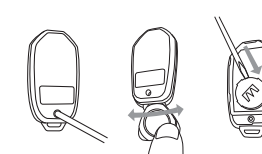

2. Installation Guides

2.1 Host battery replacement and installation

2.1.1. Factory will install the battery by default. If the battery requires a replacement or installs new batteries, please follows below figures method by open bottom cover, install 3 pcs AAA alkaline battery. The host produce 3 times short "Bi" sound and indicates turn on and use the host directly; Recommend disassemble the battery if it does not use for long period of time.

2.1.2. It is recommended to avoid installation in locations where exposed to long-term and high-temperature sunlight. Too high temperature will accelerate battery self-discharge and shorten battery life. Please replace the battery in time when the battery is low, otherwise there is a risk of liquid leakage and damage to the host.

Dismantle bottom cover method figure :

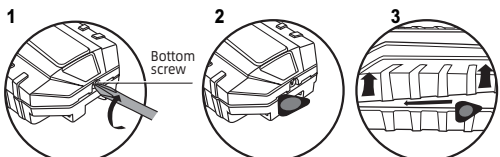

Remove the host's 1pc bottom screw and use minus (-) screwdriver to open bottom cover by rotate or turn around. After open the bottom cover, continue to open side of the cover until it is easily dismantled by hand. If do not have minus (-) screwdriver, can try use a solid film or shim to open as show in above figure.

2.2. Application and Setting

2.2.1 ARM & DISARM

2.2.1.1 Press once time on remote control [] key in standby mode, the host produces "Do..Le..Mi" sound and enter into ARM mode, after 5 seconds, a "Bi" sound and enter into alert mode. Any touch or hit is occurred at ARM alert mode, the host will trigger the alarm immediately for 2 seconds, detect on any touch or hit again within 2~ 12 seconds, the alarm will continue for 30 seconds (one ringtone type for 2 seconds alarm; 6 ringtones types for 30 seconds with automatic switching).

2.2.1.2 Press remote control [] key once at alert situation, the host will produces once "Mi..Le..Do" sound and signals the host was exited from alert mode already.

2.2.1.3 When the host is still alarming, direct press remote control DISARM key to stop and exit from ARM mode simultaneously.

2.2.2. Touch Sensivity Level, Volume, SOS setting feature

2.2.2.1 Touch sensivity has 7 levels from high to low, 7 ringtones sound prompt, Do, Le, Mi, Fa, So, La, Di; Volume has 3 levels, high, medium and low.

2.2.2.2 SOS is an internationally popular feature and off mode at factory default setting. Note that the SOS function will recognize the installation state of the host, so please do not change the installation direction again after complete the installation, otherwise it may cause

the function to fail or be abnormal. After the SOS function is turned on, it will automatically call of when the bicycle is tilted more than 45degrees by accidentally. After corrected back the bicycle to the original position, it will turn off the call of automatically. The SOS trigger sound is in accordance with international conventions/standards.

2.2.2.3 Setting method

Press and hold remote [] key, the host will continuously prompts the disarming sound (please ignore the sound) until remote LED light off and on again before release the hand. The host enters into setting feature.

*To adjust the sensitivity level, press [] key continuously from high to low in cycle with seven adjustable levels.

*To adjust the volume, press [] key continuously from high to low in cycle with 3 adjustable levels.

*In case of the SOS function is turned off, press the [] key once, the host will "Bi" sound once to enter into the calibration mode, and then "Bi. Bi. Bi. Bi. Bi." 5 beeps are correct calibrated, and the SOS function is successfully turn on; Otherwise two long "Bi... Bi" sounds is a calibration error and fail to turn on (The host shall be placed in static mode before performs the SOS calibration).

* In case of the SOS function is turned on successfully, press the [] key once, long "Bi" sound twice to turn off SOS function. After complete the setting, press [] key, the host will exits the setting function.

2.2.2.4 The host changes the batteries, sensitivity level and volume setting memories will be stored. Because of SOS may needs to recalibrate, so it will automatically turn off.

2.2.3 Bell Ringtone switching function

Press [] key, 3 ringtones to choose and cyclic beeping (ARM mode can not use).

2.2.4 Bell and search function : Press bell key and trigger selected bell ringtone to find the motorbike/bicycle easily.

2.2.5 Remote control Learning Code

2.2.5.1 The first remote control code learning method: At first, remove the host batteries and install back after 30 seconds. Long press remote control [] key to enter the code learning mode. After the host produces once "Bi" sound, press ARM or DISARM key with twice "Bi..Bi.." sound, you should able to use new added remote control already.

2.2.5.2 To add more remote controls code learning method :Press old remote control' s DISARM key to disarm at first, then, long press at old remote control [] to enter code learning mode, After once 'Bi' sound, press new remote control' s ARM or DISARM key with twice "Bi ... Bi" sound, you should able to use new added remote control already.

2.2.5.3 Decoding method: Be cautious when use this function! At first, confirm the host is not at ARM mode; Long press for coded remote control [] key to enter into the code learning mode. After

once "Bi" sound, press [] key with "Bi ... Bi ... Bi" 3 times sound, the host will delete all coded addresses. Please refer to above method for new code learning.

2.2.5.4 Be cautious of the host can caters up to 8 remote controls coding only, the first registered remote control coding will be removed if exceeds 8 remote controls registration.

2.2.6 Battery low power indication

2.2.6.1 When the host is at low battery (3.3V) condition, a weak "Du..Du.." 2 times sound was generated when use ARM or DISARM and requires to replace the battery immediately.

2.2.6.2 When the remote control' s flashlight becomes dark/fade or remote control range becomes shorter, it indicates the battery power is low and replaces with a new battery accordingly.

3. Operating Guides

3.1. The host uses 3 pcs AAA alkaline battery, normal usage 1~3 months; Standby (continuously): ~ 6 months.

3.2. WL03C: 1 pc 27A (12V) alkaline battery
WL09C: 1pc CR2032(3V) button battery
normal usage more than 1 year (Assume: 5 times usage/day)

3.3. Operating environment temperatures: ~-20~+60 C

3.4. Operating environment humidity : R/H <80%

3.5. Storage temperature: -30 C ~+70 C