



RAZER NAR LIT MATT

MASTER GUIDE

The **Razer Nari Ultimate** is the wireless gaming headset equipped with HyperSense technology for an additional layer of immersion. The swiveling earcups are equipped with cooling gel-infused cushions with memory foam that reduce heat buildup for comfortable gaming. THX Spatial Audio delivers next-generation virtual surround sound, while Game/Chat Balance in wireless mode provides the perfect mix of game and chat volume. The headset also functions in wired mode with both USB and 3.5 mm analog options. Powered by Razer Chroma™.

CONTENTS

1. PACKAGE CONTENTS / SYSTEM REQUIREMENTS.....	3
2. REGISTRATION / TECHNICAL SUPPORT.....	4
3. TECHNICAL SPECIFICATIONS.....	5
4. DEVICE LAYOUT.....	6
5. SETTING UP YOUR RAZER NARI ULTIMATE.....	7
6. USING YOUR RAZER NARI ULTIMATE.....	12
7. INSTALLING RAZER SYNAPSE 3 FOR YOUR RAZER NARI ULTIMATE.....	15
8. CONFIGURING YOUR RAZER NARI ULTIMATE VIA RAZER SYNAPSE 3.....	16
9. SAFETY AND MAINTENANCE.....	27
10. LEGALESE.....	28

1. PACKAGE CONTENTS / SYSTEM REQUIREMENTS

PACKAGE CONTENTS

- Razer Nari Ultimate gaming headset
- USB wireless transceiver
- Charging cable
- 3.5mm combo cable
- Important Product Information Guide

SYSTEM REQUIREMENTS

HARDWARE REQUIREMENTS

- Devices with a USB port
- Mobile devices with a 3.5mm combo port

RAZER SYNAPSE 3 REQUIREMENTS

- Windows® 7 64-bit (or higher)
- Internet connection

2. REGISTRATION / TECHNICAL SUPPORT

REGISTRATION

Register your product online at razerid.razer.com/warranty to get real-time information on your product's warranty status.

If you haven't registered for a Razer ID yet, register now at razerid.razer.com to get a wide range of Razer benefits.

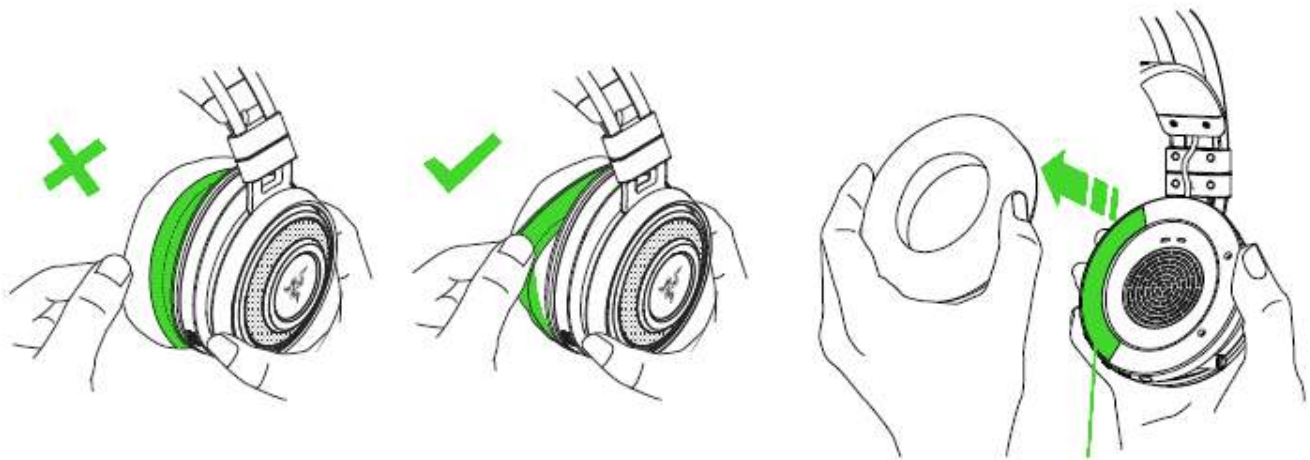

Your product's serial number can be found underneath the leatherette cushion, as shown here.

TECHNICAL SUPPORT

- 1 year limited manufacturer's warranty.
- Free online technical support at support.razer.com.

3. TECHNICAL SPECIFICATIONS

HEADPHONES

- Frequency response: 20 Hz – 20 kHz
- Impedance: 32Ω at 1 kHz
- Sensitivity (@1 kHz): 107 ± 3 dB
- Input power: 30 mW (Max)
- Drivers: 50 mm, with Neodymium magnets
- Inner ear cup diameter: Width 56mm / Length 67mm
- Oval ear cushions: Designed for full-ear coverage with cooling gel, perfect for long-wearing comfort
- Connection type: Wireless USB Transceiver / 3.5mm analog
- Wireless range: 12 m / 40 ft
- Wireless frequency: 2.4 GHz
- Analog connection: 4 – pole
- Battery life: 8 hours with Razer Chroma lighting and HyperSense / 24 hours without Razer Chroma lighting and HyperSense

MICROPHONE

- Frequency response: 100 – 6.5 kHz
- Signal-to-noise ratio: > 50 dB
- Sensitivity (@1 kHz): -42 ± 3 dB
- Pick-up pattern: Unidirectional

LOFELT L5 HAPTIC

- 1 in each earcup
- Frequency Response: 20 – 200 Hz
- Maximum Generated Force: 4.3 G
- Intelligent Digital Signal Processing

4. DEVICE LAYOUT

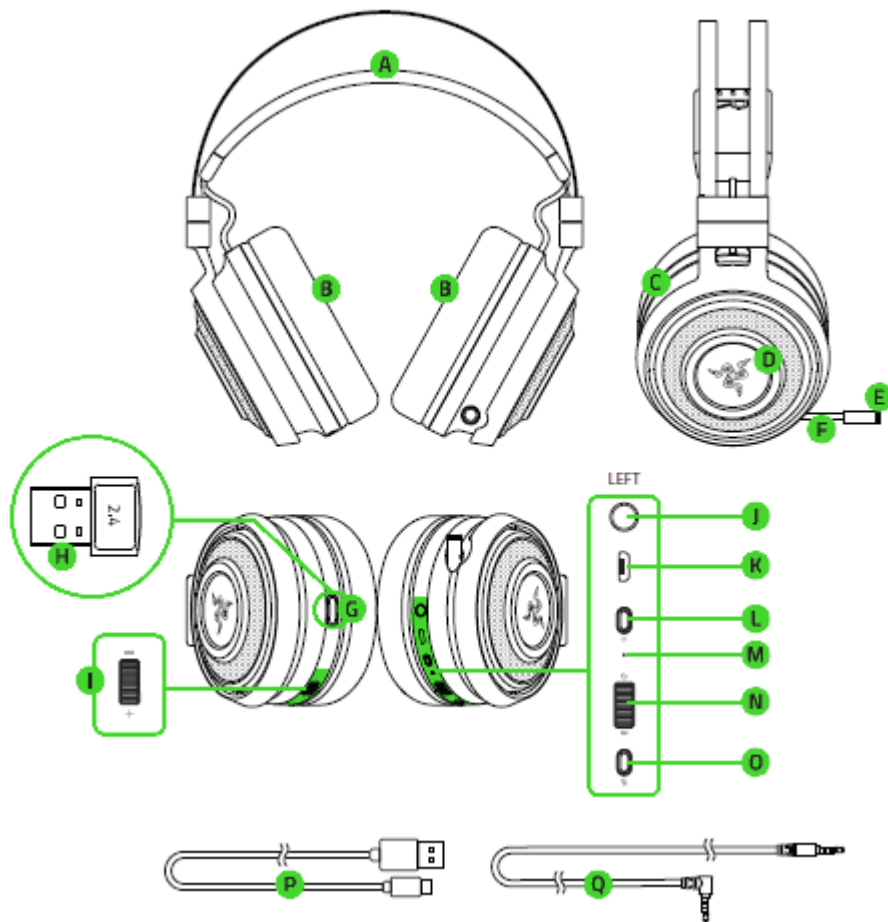

- A. Auto-adjusting headband
- B. Cooling gel-infused ear cushions
- C. 50mm drivers with HyperSense Technology
- D. Razer Chroma backlighting
- E. Mic mute indicator
- F. Retractable mic
- G. Transceiver storage
- H. USB wireless transceiver
- I. Volume control
- J. 3.5mm combo port
- K. Charging port
- L. Power button
- M. Status indicator
- N. Game/Chat balance
- O. Mic mute button
- P. Charging cable
- Q. 3.5mm combo cable

5. SETTING UP YOUR RAZER NARI ULTIMATE

CHARGING YOUR HEADSET

Connect your Razer Nari Ultimate to a powered USB port using the charging cable.

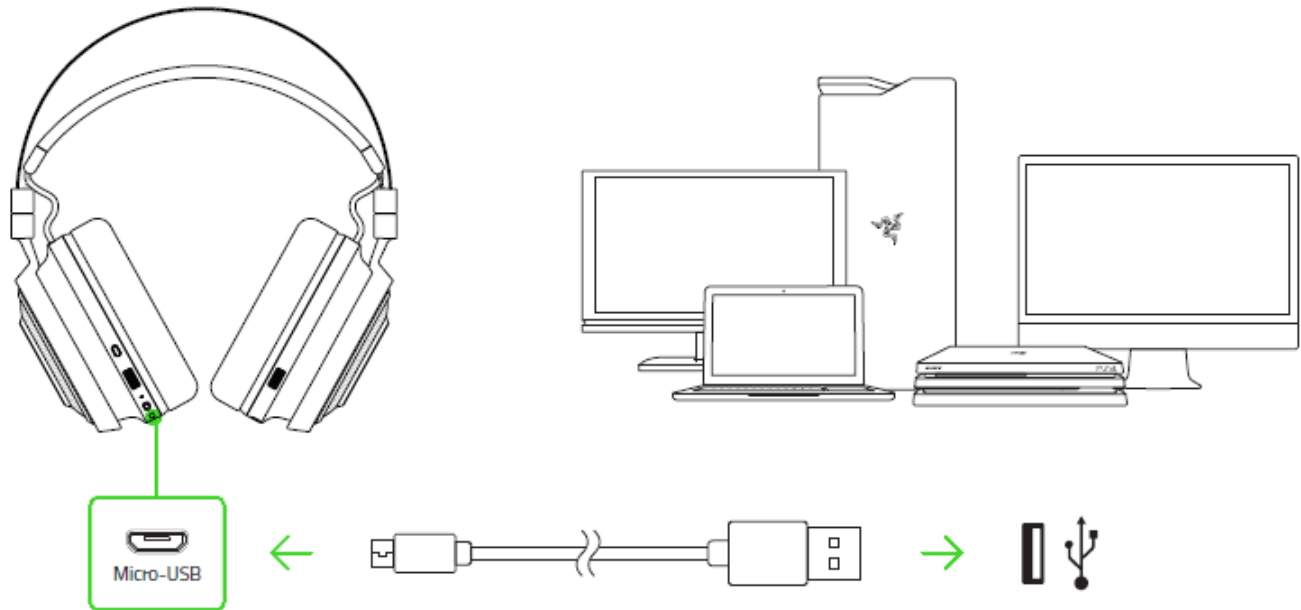







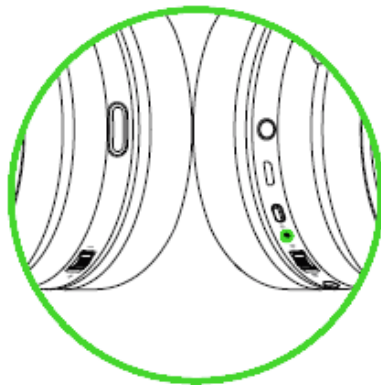

For best results, please fully charge your headset before using it for the first time. A depleted unit will fully charge in about **4 hours**.

UNDERSTANDING THE CHARGING NOTIFICATIONS

Your Razer Nari Ultimate will send out notifications depending on its current charging status, as shown here:



STATUS INDICATOR	SOUND INDICATOR	DESCRIPTION
Static red 	None 	Charging/low battery 
Static green 	None 	Fully charged/full battery 
Blinking red 	Warning tone 	Battery is critically low 

CONNECTING TO YOUR PC VIA USB PORT

1. Plug the USB wireless transceiver to your PC.

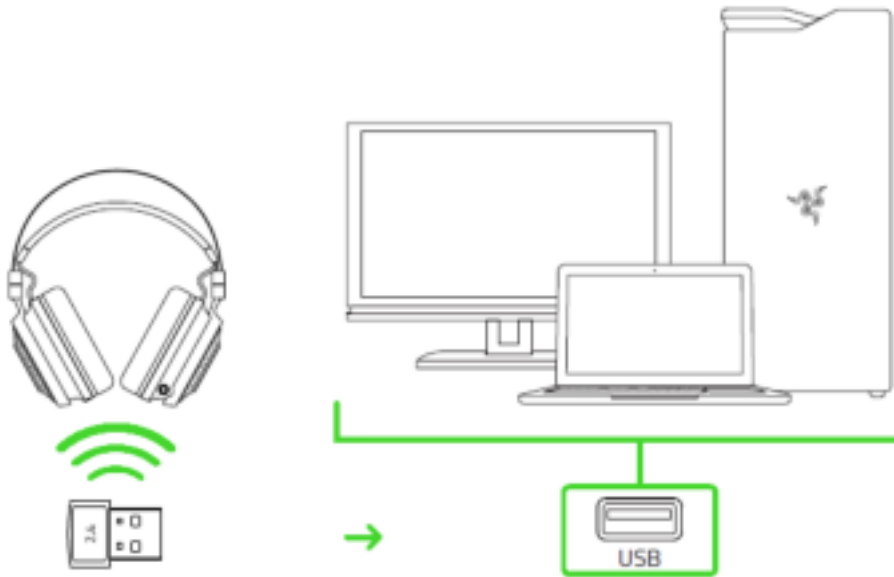

2. Right-click on the sound icon on the system tray, and then select **Sounds**.

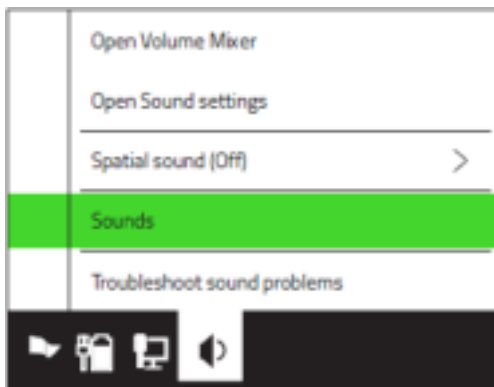

3. On the Playback tab, select **Razer Nari Ultimate - Chat** from the list, and then set it as the **Default Communication Device**.



4. On the Playback tab, select **Razer Nari Ultimate - Game** from the list, and then set it as the **Default Device**.



5. In the Recording tab, select **Razer Nari Ultimate - Chat** from the list and click the **Set Default** button.



CONNECTING TO OTHER DEVICES VIA USB PORT

1. Push in the USB wireless transceiver until you hear a click then release your finger so that it ejects from your headset.

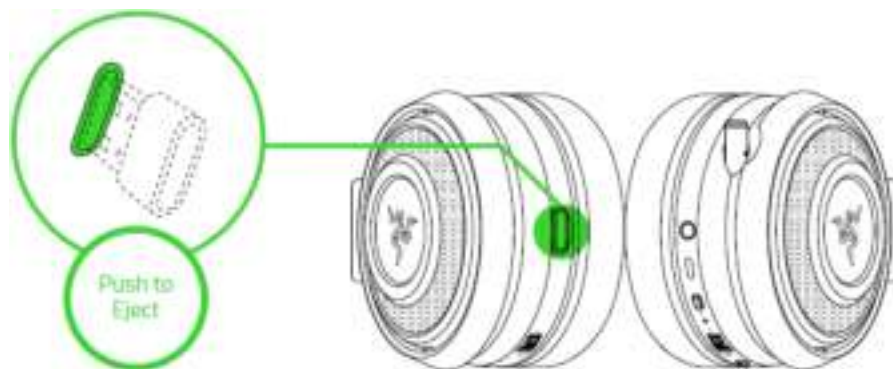

Note: To return the USB wireless transceiver, push it into the compartment until you hear a click.

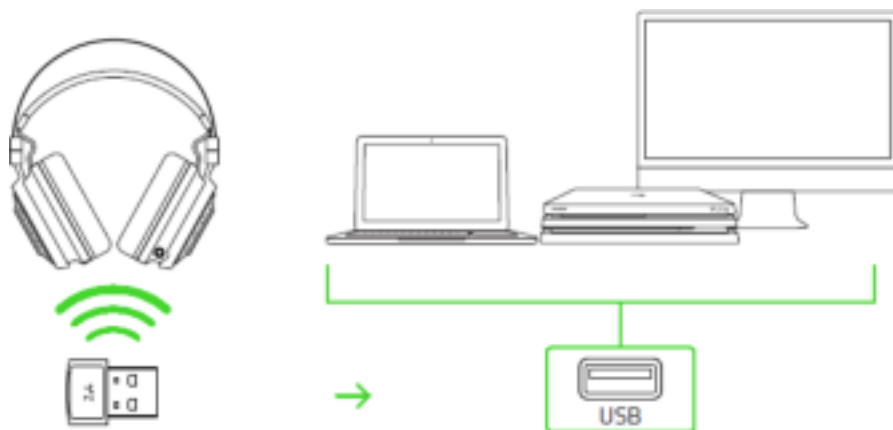

2. Plug the USB wireless transceiver to your device and make sure your Razer Nari Ultimate is the default input and output audio device.

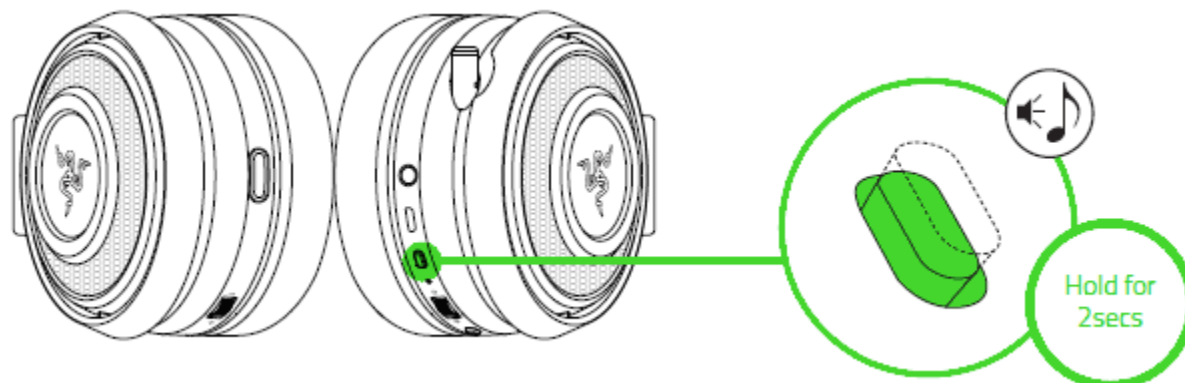

3. Power on your headset by holding the power button for at least 3 seconds or until you hear 2 short beeps.



4. Wait until the status indicator is static blue.

NOTIFICATION	STATUS
Blinking 	Pairing
Rapid blinking 	Connecting
Static 	Connected

Note: Keep your headset within close proximity of the USB wireless transceiver for a faster and more stable connection. If your headset fails to connect, it will automatically power off after a few minutes. If successful, the status indicator will remain static for a few seconds and then the light will turn off.

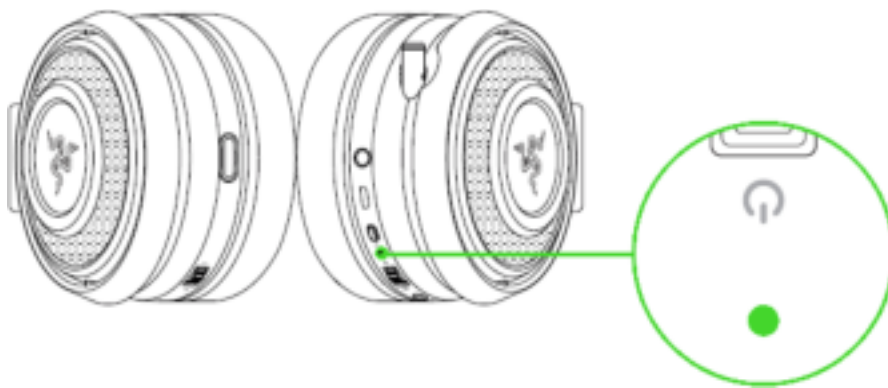

CONNECTING TO DEVICES VIA 3.5MM COMBO PORT

If your device has a 3.5mm audio + mic combined jack, simply plug the 3.5mm audio cable from your headset to your device's audio jack.

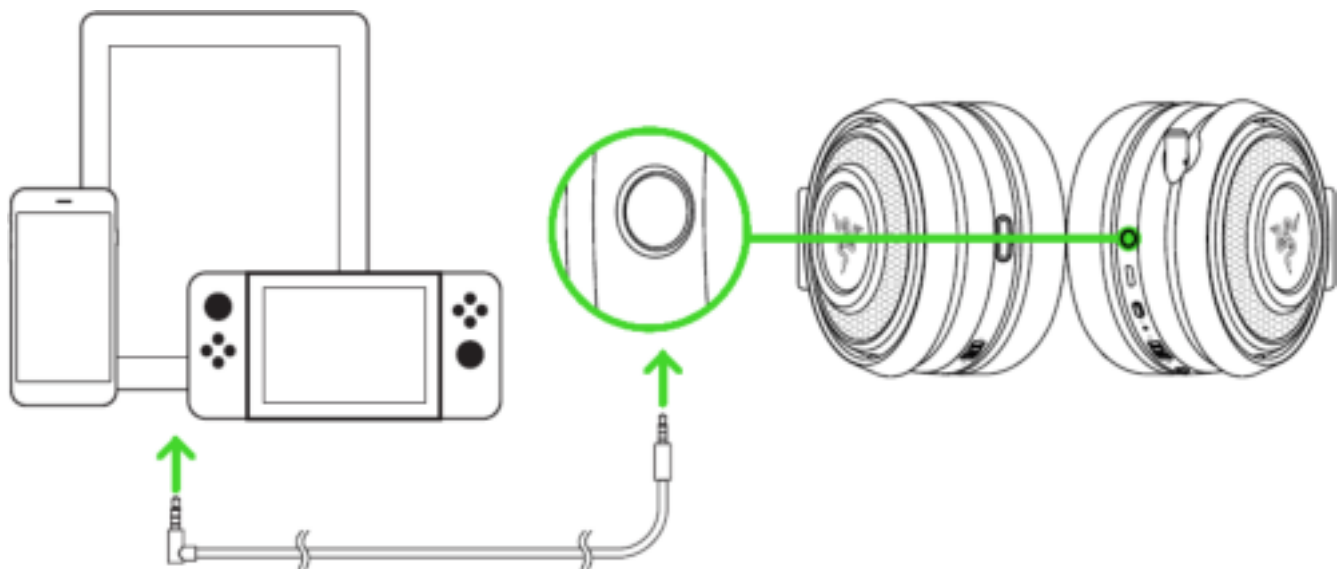

6. USING YOUR RAZER NARI ULTIMATE

USING THE VOLUME CONTROL

Rotate the volume control to increase or decrease the volume.

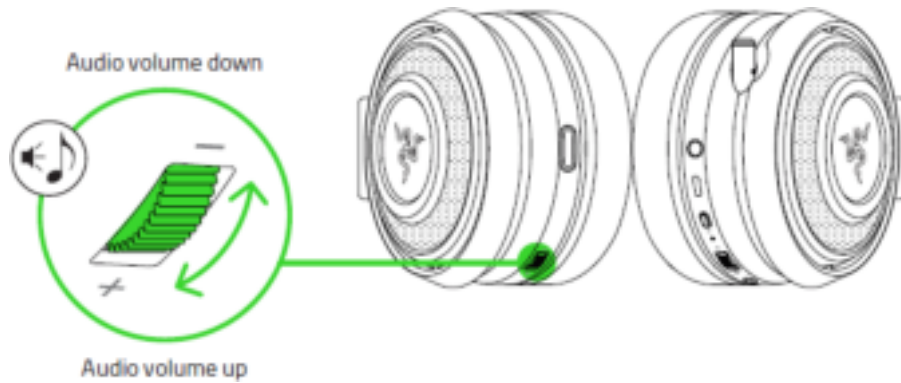

USING THE GAME/CHAT BALANCE

Rotate the game/chat balance to increase the in-game volume and decrease the voice chat volume or vice versa. By default, the notch on the wheel is set to the middle to indicate 50% chat and 50% game volume.

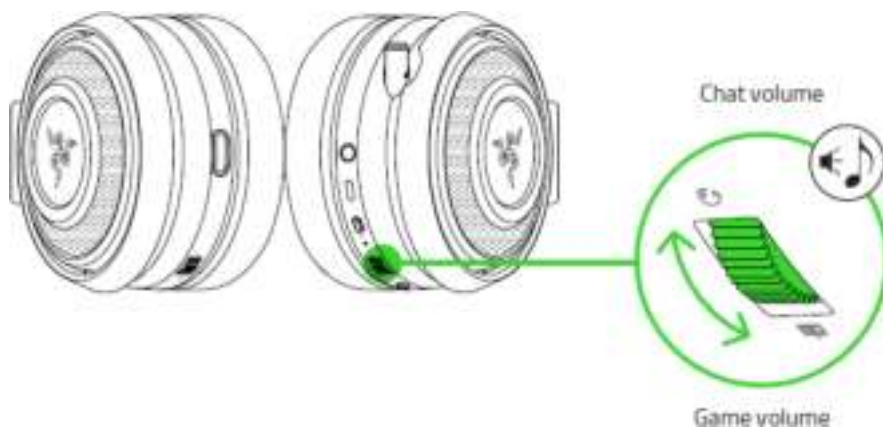

USING THE RETRACTABLE MIC

Pull the tip of the mic until it is fully extended.

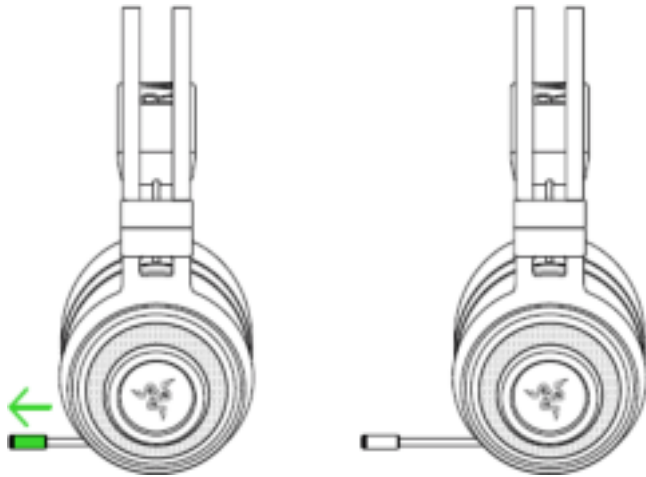

Bend the mic until it is parallel to your mouth, then adjust the length as preferred. Make sure the mic diaphragm is in front and the air vent is facing away from your mouth.

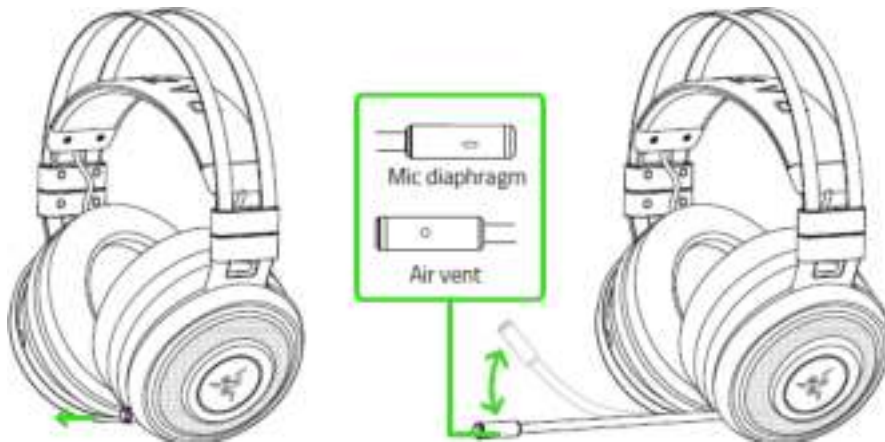

Press the mic mute button to mute or unmute the mic. The mic mute indicator will light up when muted.

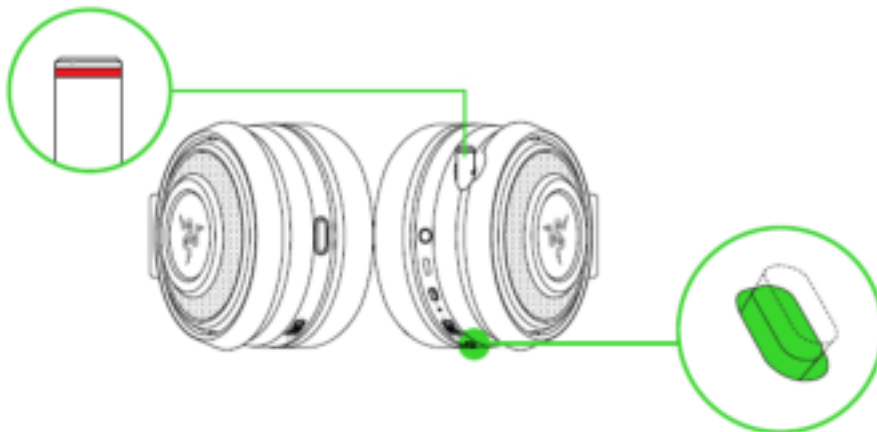

EXTENDING YOUR HEADSET'S LIFESPAN

We recommend stretching the headset gently apart before placing them over your head to minimize headband stress. However, please avoid overstretching the headset beyond its technical limits.

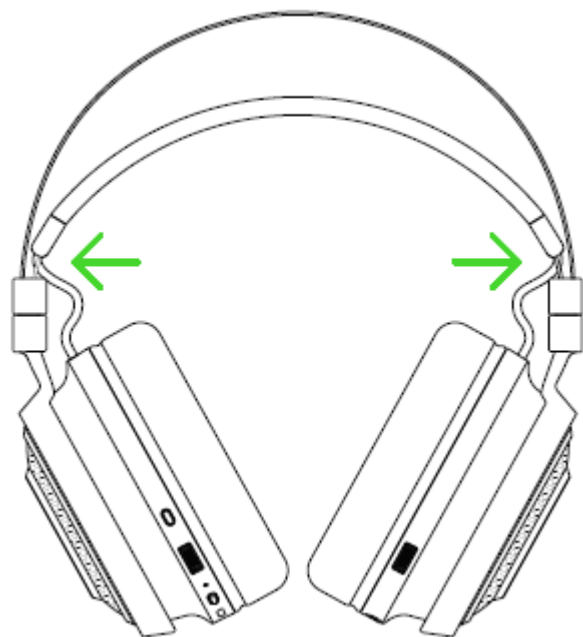

7. INSTALLING RAZER SYNAPSE 3 FOR YOUR RAZER NARI ULTIMATE

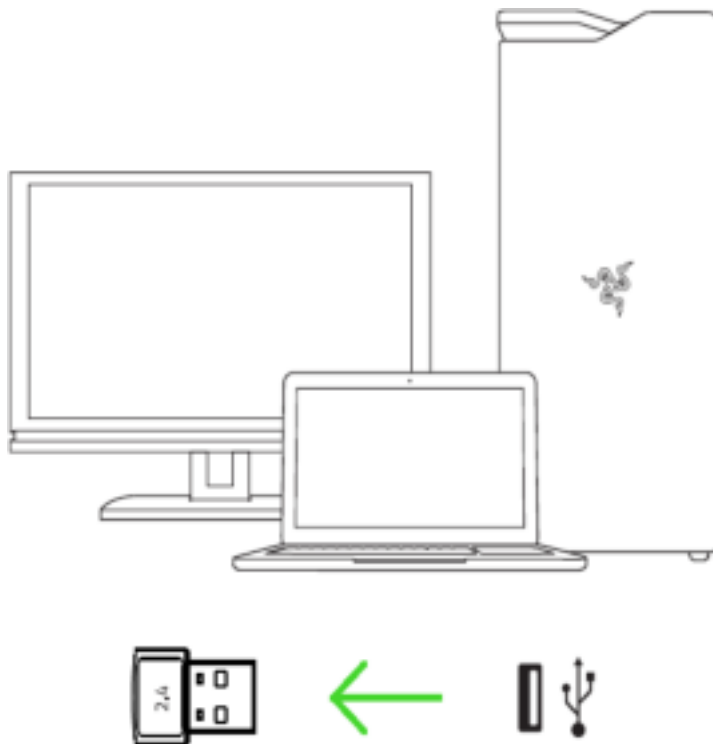

Step 1: Make sure your Razer device is connected to the USB port of your computer.

Step 2: Install Razer Synapse 3 when prompted* or download the installer from razer.com/synapse.

Step 3: Create your Razer ID or log in using an existing account.

**Applicable for Windows 8 or later.*

8. CONFIGURING YOUR RAZER NARI ULTIMATE VIA RAZER SYNAPSE 3

Disclaimer: The features listed here require you to log in to Razer Synapse. These features are also subject to change based on the current software version and your Operating System.

SYNAPSE TAB

The Synapse tab is your default tab when you first launch Razer Synapse 3. This tab allows you to navigate the Dashboard subtab.

DASHBOARD

The Dashboard subtab is an overview of your Razer Synapse 3 where you can access all your Razer devices, modules, and online services.

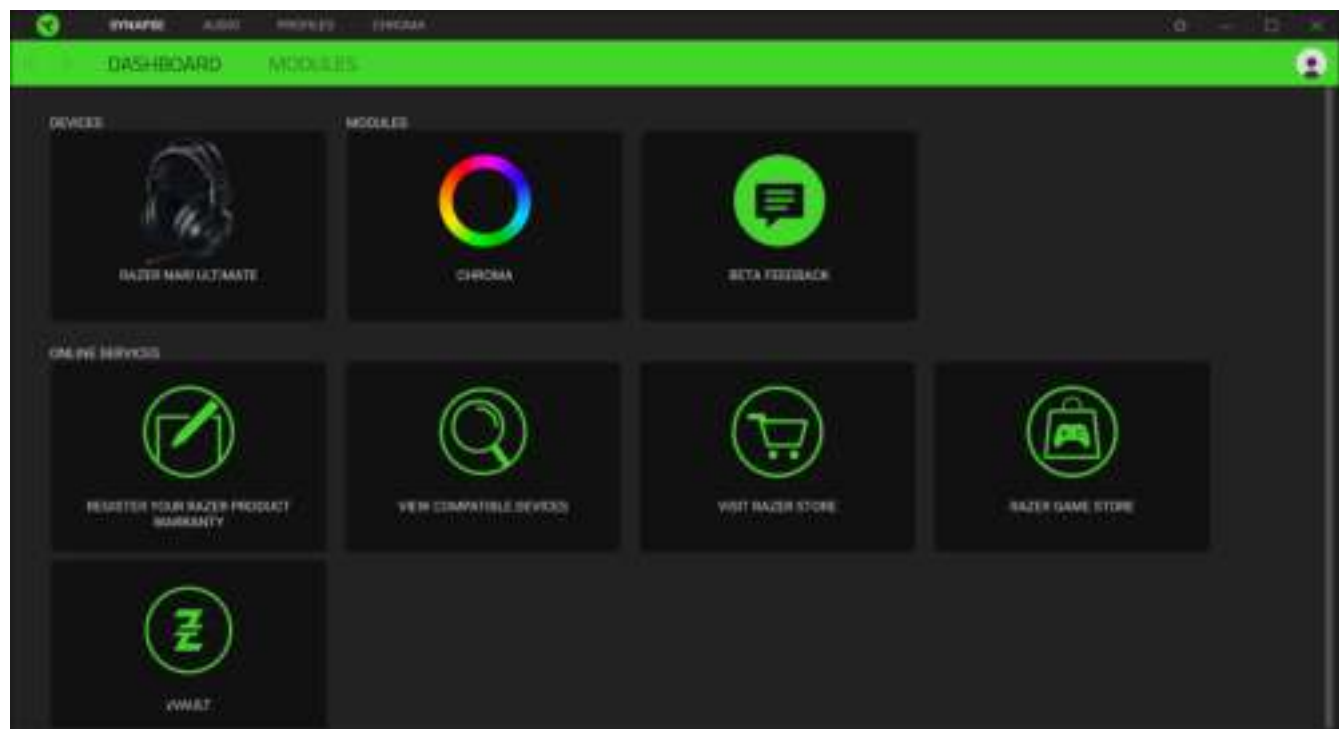

AUDIO TAB

The Audio tab is the main tab for your Razer Nari Ultimate. From here, you can customize your device's settings to unleash its full potential. Changes made under this tab are automatically saved to your system and cloud storage.

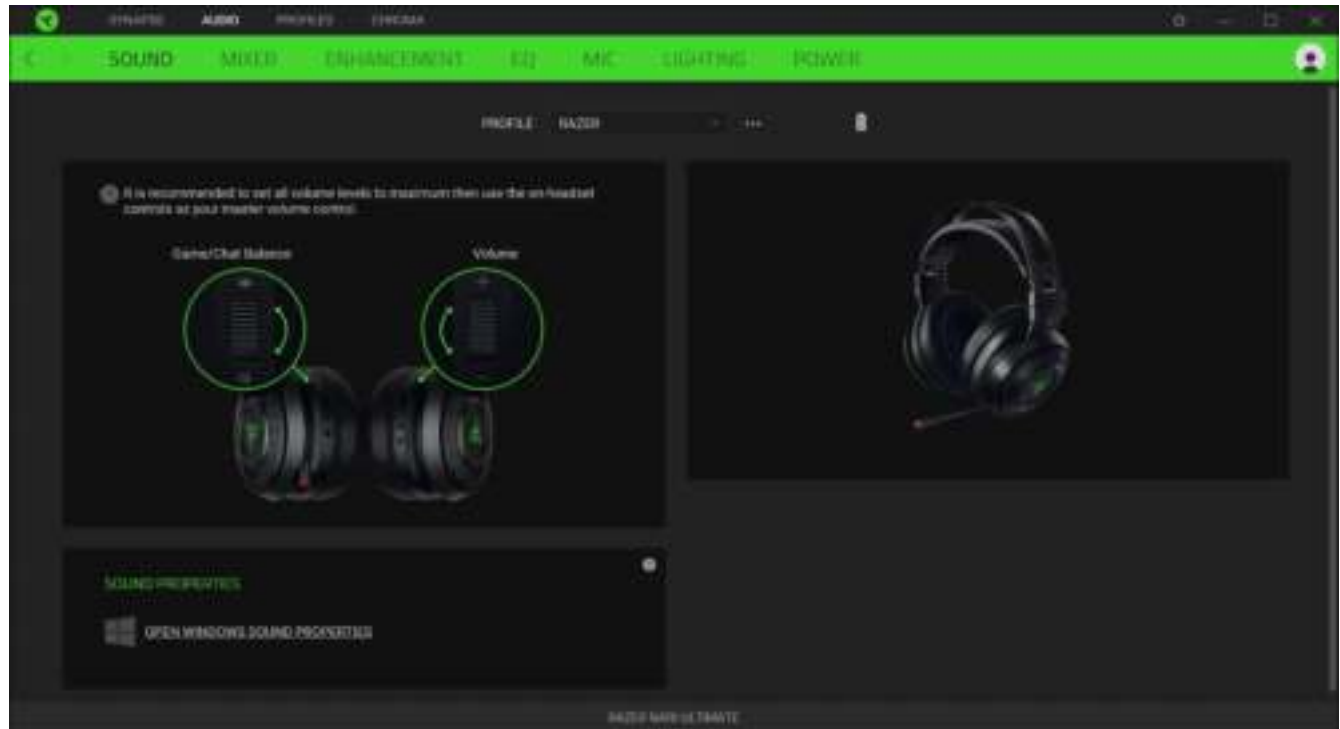

SOUND

The Sound subtab is for modifying your device's sound properties.

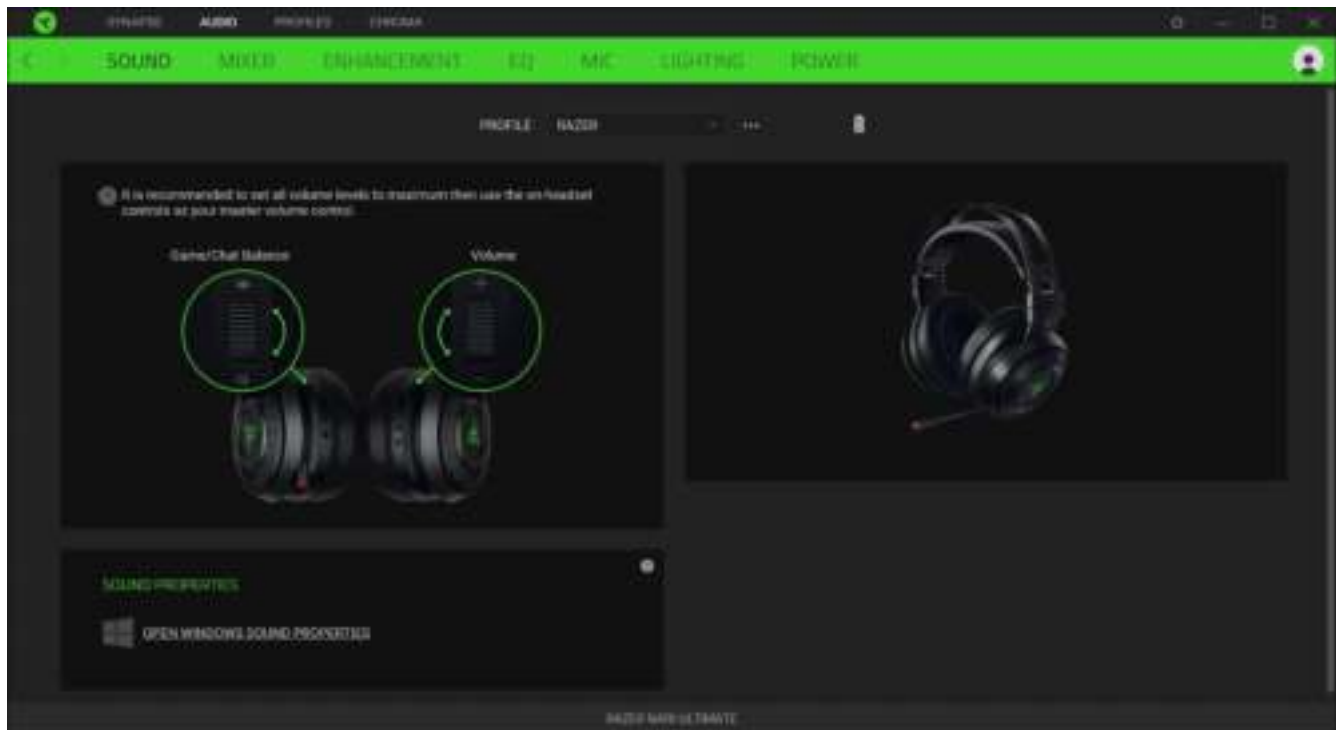

Profile

Profile is a data storage for keeping all your Razer peripheral's settings. By default, the profile name is based on your system's name. To add, rename, duplicate, or delete a profile, simply press the Miscellaneous button { ⋮ }.

Sound Properties

Clicking the link will launch the Windows sound properties window.

MIXER

The Mixer subtab allows you to enable/disable the THX Spatial Audio, as well as calibrate the audio positioning.

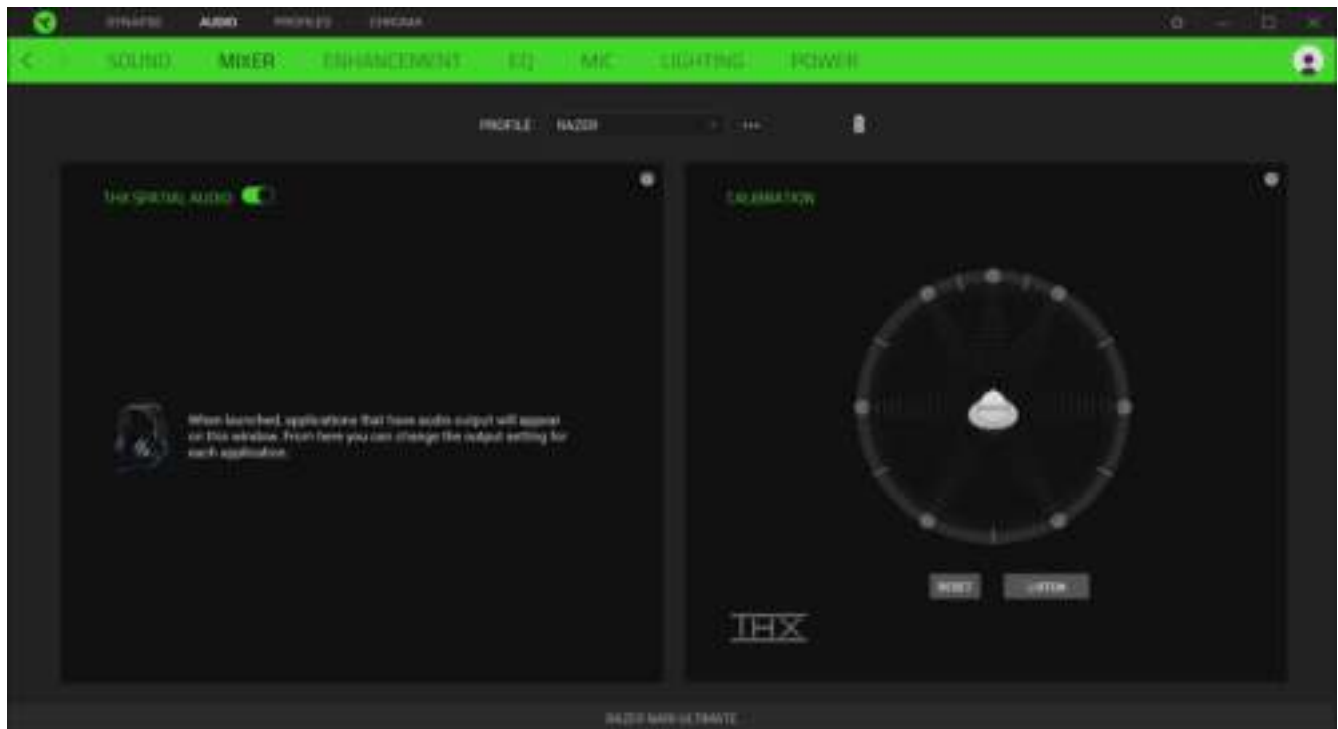

ENHANCEMENT

The Enhancement subtab is for customizing the incoming audio settings.

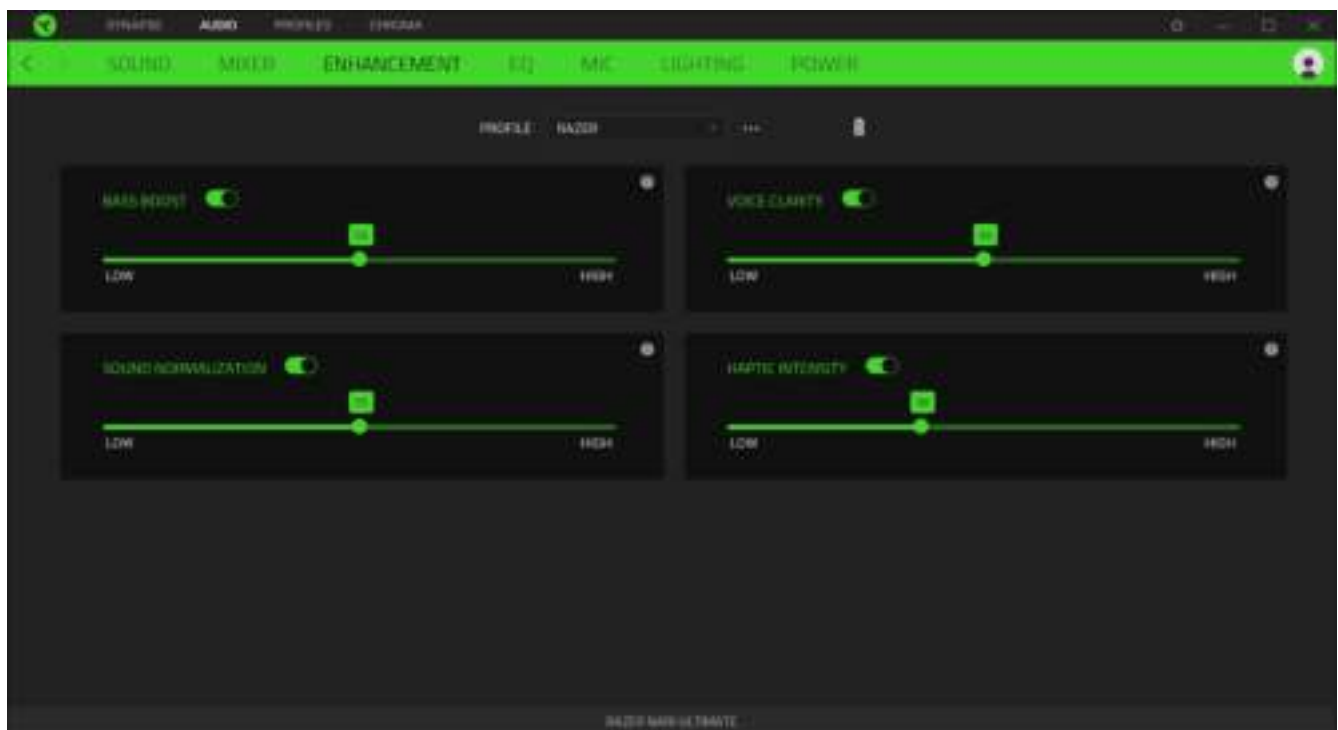

Bass Boost

Enhances the low frequency response to improve the bass output of your headset

Sound Normalization

Reduces the loudest audio received to avoid sudden and unpleasant increase in volume from effects such as shouting or explosions.

Voice Clarity

Improves the quality of incoming voice conversations by filtering the sound to improve clarity and adjusts the volume.

Haptic Intensity

Adjusts the intensity of the touch-sensory feedback

EQ

With the EQ subtab, you can alter the frequency response of your audio system.



MIC

The Mic subtab enables you to change the settings for all outgoing mic audio.

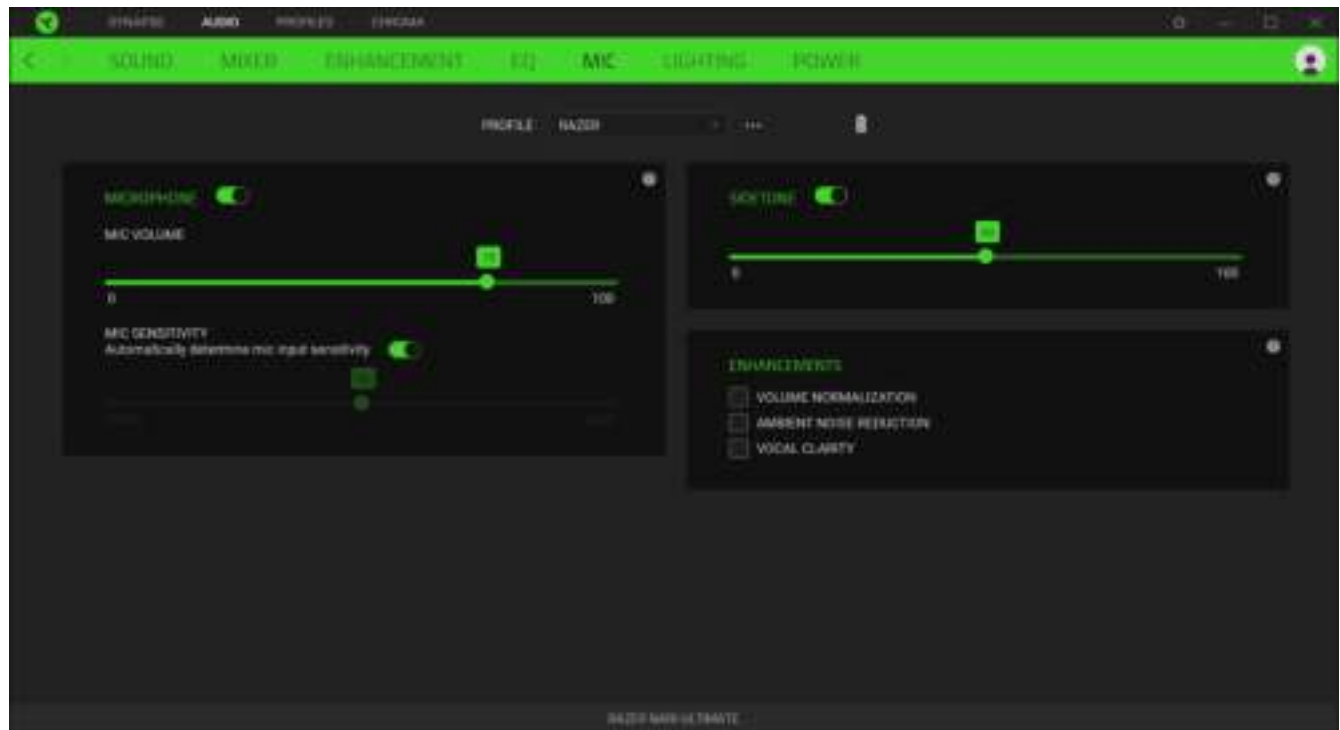

Mic Volume

Adjusts the microphone input or mutes the mic when the function is disabled.

Mic Sensitivity

Changes the microphone's sensitivity so that it cuts out background noises and isolate your voice.

Sidetone

Monitors the microphone's raw audio input through the headset with an additional option to increase or decrease the volume.

Enhancements

Improves the quality of the microphone input by:

- reducing the variation of loudness via **Volume Normalization**
- decreasing environmental noise through **Ambient Noise Reduction**
- emphasizing the voice frequency by means of **Vocal Clarity**

Lighting

The Lighting subtab enables you to modify your Razer device's light settings.

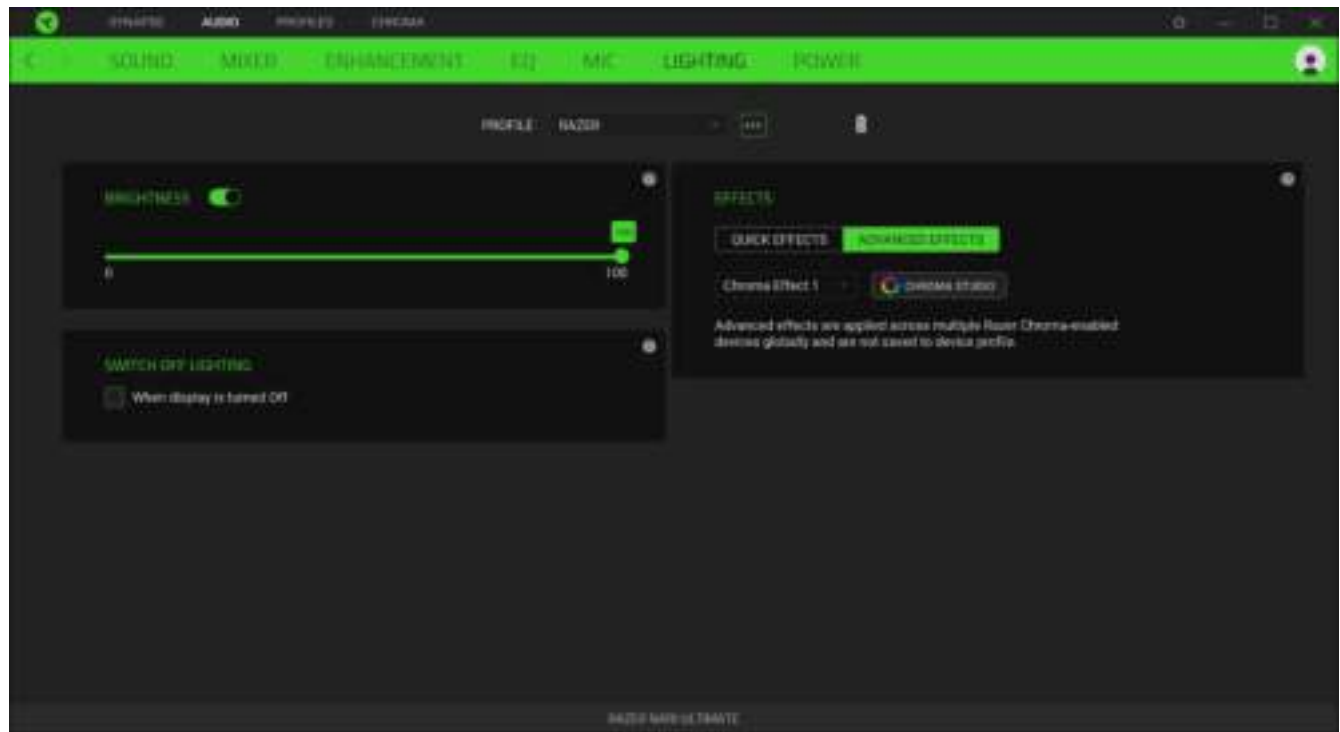

Brightness

You can turn off your Razer device's lighting by toggling the Brightness option or increase/decrease the luminance using the slider.

Switch Off Lighting

This is a power saving tool which allows you to disable your device's lighting in response to your system's display turning off and/or automatically power down when your Razer Nari Ultimate has been idle for a set amount of time.

Quick Effects

A number of quick effects can be selected and applied to your headset's lighting, as listed here:

	Name	Description	How to set up
	Breathing	The lighting fades in and out of the selected color(s)	Select up to 2 colors or randomize

	Spectrum cycling	The LEDs will cycle between 16.8 million colors indefinitely	No further customization required
	Static	The LEDs will remain lit in the selected color	Select a color

If you have other supported Razer Chroma-enabled devices, you can synchronize their quick effects with your Razer device by clicking the Chroma Sync button ().

Advanced Effects

The Advanced Effects option allows you to choose a Chroma Effect you want to use on your Razer Chroma-enabled peripheral. To start making your own Chroma Effect, simply press the Chroma Studio button (). [Click here to learn more about the Chroma Studio](#)

Power

The Power subtab allows you to manage your device's energy consumption when running on batteries. You can set your device to enter sleep mode when it has been idle for a certain amount of time.

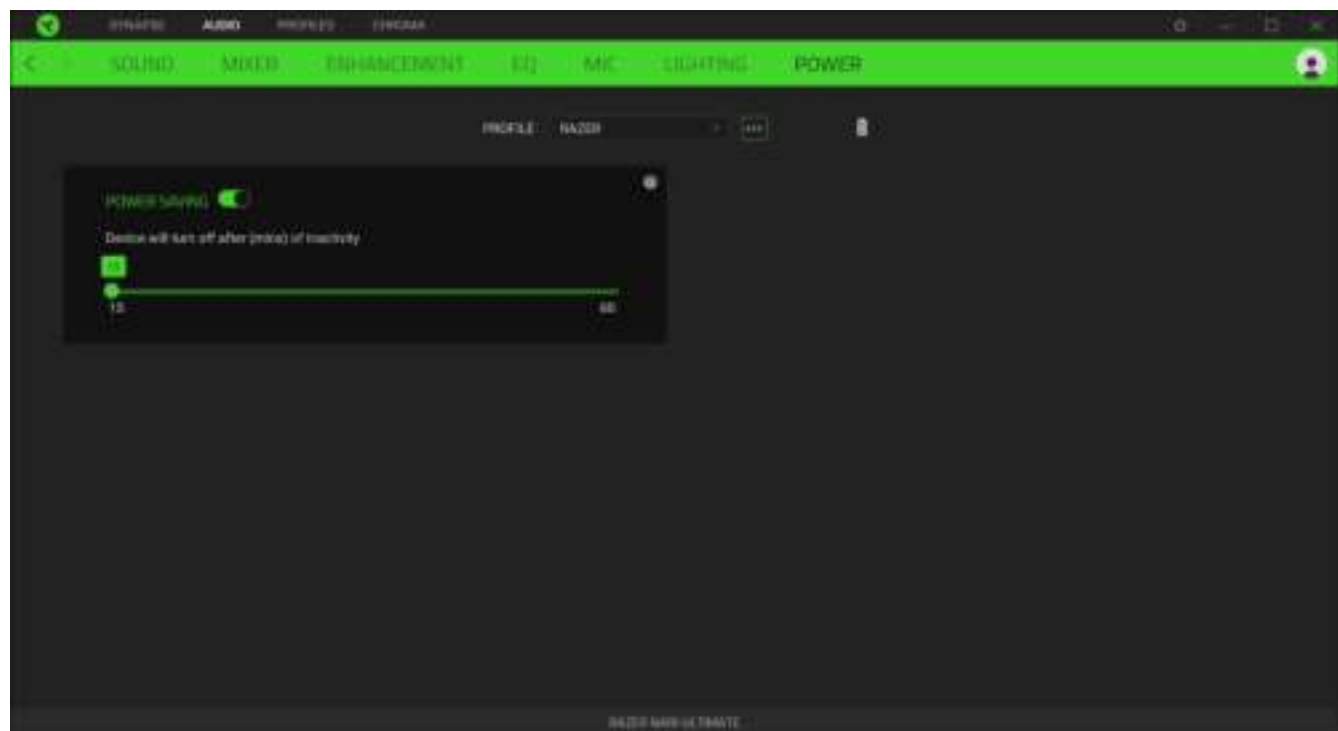

PROFILES TAB

The Profiles tab is a convenient way of managing all your profiles and linking them to your games and applications.

DEVICES

View which Razer device is using a specific profile using the Devices subtab. To create a new profile within the selected device, simply click the add button (+). To rename, duplicate, or delete a profile, simply press the Miscellaneous button (⋮). Each profile can be set to automatically activate when you run an application using the Link Games option.

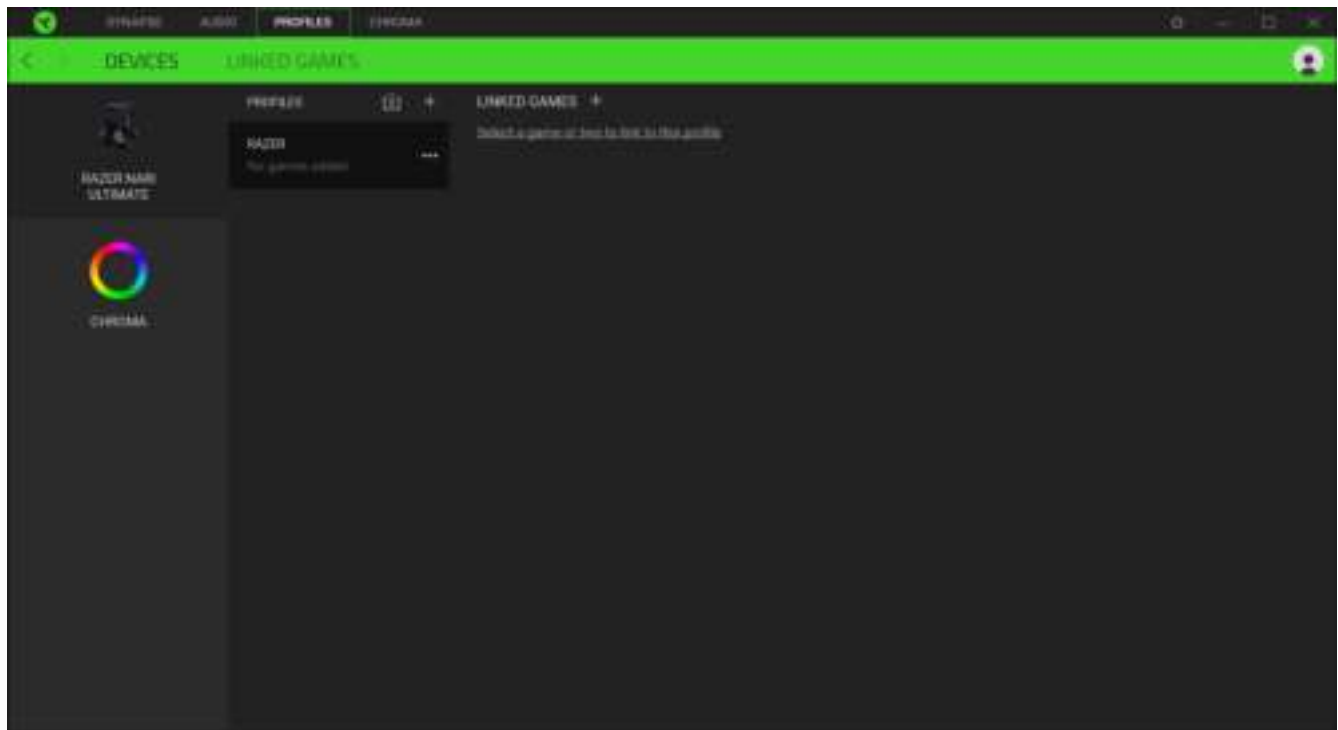

LINKED GAMES

The Linked Games subtab gives you the flexibility to add games, view peripherals that are linked to games, or search for added games. You can also sort games based on alphabetical order, last played, or most played. Added games will still be listed here even if it is not linked to a Razer device.

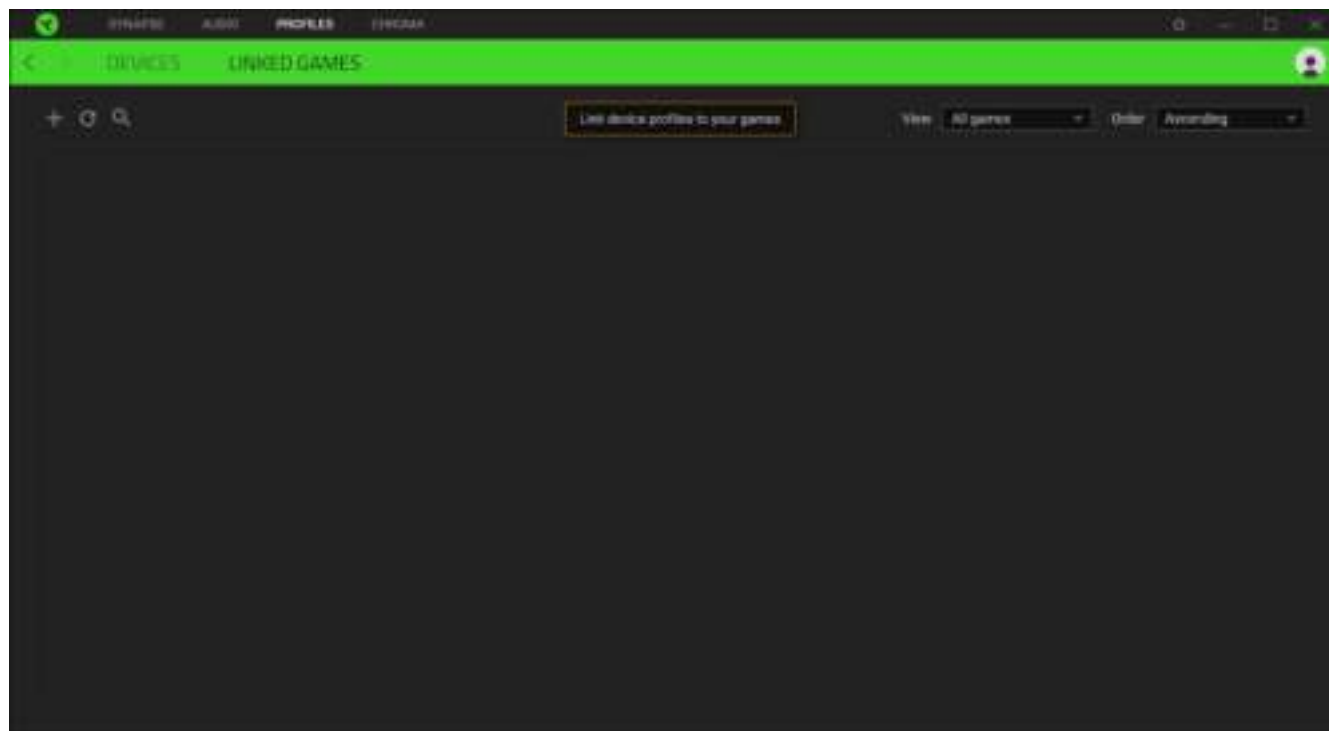

SETTINGS WINDOW

The Settings window, accessible by clicking the (⚙️) button on Razer Synapse 3, enables you to configure the startup behavior, change language, view your Razer device's master guide, or perform factory reset on any connected Razer device.

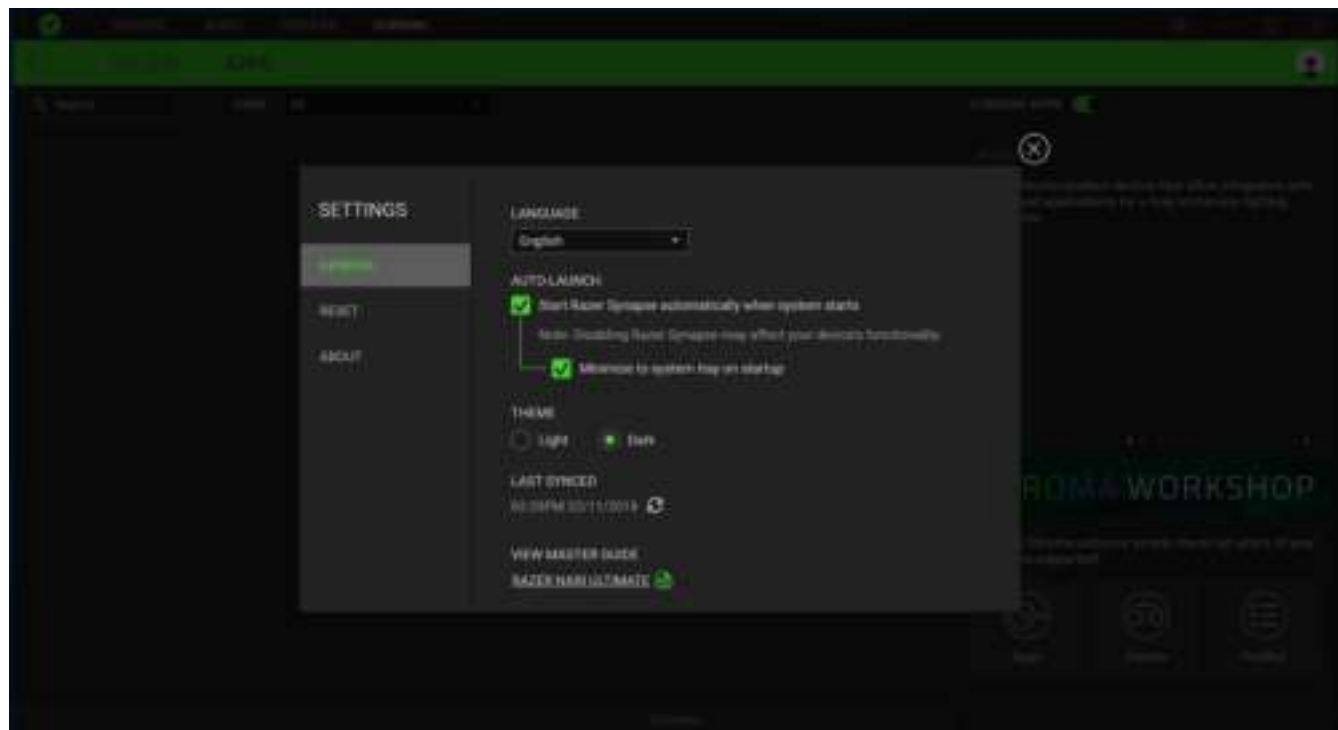

GENERAL

The default tab of the Settings window. The General tab enables you to change the software's display language and start-up behavior, or view the master guide of all connected Razer devices.

RESET

The Reset tab allows you to perform a factory reset on all connected Razer devices with on-board memory. All profiles stored on the selected device's on-board memory will be erased.

Note: Performing a factory reset on devices without on-board memory will only create a new profile for your device on Razer Synapse 3 using the default settings.

ABOUT

The About tab displays brief software information, its copyright statement, and also provides relevant links for its terms of use. You may also use this tab to check for software updates, or as a quick access to Razer's social communities.

9. SAFETY AND MAINTENANCE

SAFETY GUIDELINES

In order to achieve maximum safety while using your Razer Nari Ultimate, we suggest that you adopt the following guidelines:

Should you have trouble operating the device properly and troubleshooting does not work, unplug the device and contact the Razer hotline or go to support.razer.com for assistance.

Do not take apart the device (doing so will void your warranty) and do not attempt to operate it under abnormal current loads.

Keep the device away from liquid, humidity or moisture. Operate the device only within the specific temperature range of 0°C (32°F) to 40°C (104°F). Should the temperature exceed this range, unplug and/or switch off the device in order to let the temperature stabilize to an optimal level.

The device isolates external ambient sounds even at low volumes, resulting in lowered awareness of your external surroundings. Please remove the device when engaging in any activities that requires active awareness of your surroundings.

Listening to excessively loud volumes over extended periods of time can damage your hearing. Furthermore, legislation of certain countries permits a maximum sound level of 86dB to affect your hearing for 8 hours a day. We therefore recommend that you reduce the volume to a comfortable level when listening for prolonged periods of time. Please, take good care of your hearing.

MAINTENANCE AND USE

The Razer Nari Ultimate requires minimum maintenance to keep it in optimum condition. Once a month we recommend you unplug the device from the computer and clean it using a soft cloth or cotton swab with a bit of warm water to prevent dirt buildup. Do not use soap or harsh cleaning agents.

10. LEGALESE

COPYRIGHT AND INTELLECTUAL PROPERTY INFORMATION

©2019 Razer Inc. All rights reserved. Razer, the triple-headed snake logo, Razer logo, "For Gamers. By Gamers.", and "Powered by Razer Chroma" logo are trademarks or registered trademarks of Razer Inc. and/or affiliated companies in the United States or other countries. All other trademarks and trade names are the property of their respective owners and other company and product names mentioned herein may be trademarks of their respective companies.

Windows and the Windows logo are trademarks or registered trademarks of the Microsoft group of companies.

THX and the THX logo are trademarks of THX Ltd., registered in the U.S. and other countries.

Razer Inc. ("Razer") may have copyright, trademarks, trade secrets, patents, patent applications, or other intellectual property rights (whether registered or unregistered) concerning the product in this guide. Furnishing of this guide does not give you a license to any such copyright, trademark, patent or other intellectual property right. The Razer Nari Ultimate (the "Product") may differ from pictures whether on packaging or otherwise. Razer assumes no responsibility for such differences or for any errors that may appear. Information contained herein is subject to change without notice.

LIMITED PRODUCT WARRANTY

For the latest and current terms of the Limited Product Warranty, please visit: [razer.com/warranty](https://www.razer.com/warranty).

LIMITATION OF LIABILITY

Razer shall in no event be liable for any lost profits, loss of information or data, special, incidental, indirect, punitive or consequential or incidental damages, arising in anyway out of distribution of, sale of, resale of, use of, or inability to use the Product. In no event shall Razer's liability exceed the retail purchase price of the Product.

GENERAL

These terms shall be governed by and construed under the laws of the jurisdiction in which the Product was purchased. If any term herein is held to be invalid or unenforceable, then such term (in so far as it is invalid or unenforceable) shall be given no effect and deemed to be excluded without

invalidating any of the remaining terms. Razer reserves the right to amend any term at any time without notice.