

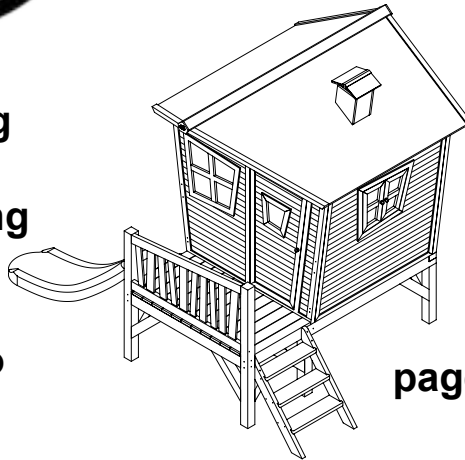

Wooden playhouse

Gebruikshandleiding
 User manual
 Gebrauchsanweisung
 Mode d'emploi
 Manual de usuario
 Istruzione per l'uso



Iris
 page 15 - 30

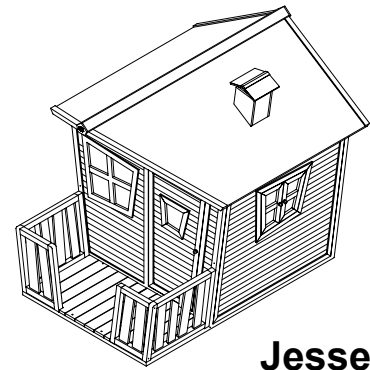

Jesse
 page 3 - 14

Emma
 page 46 - 66

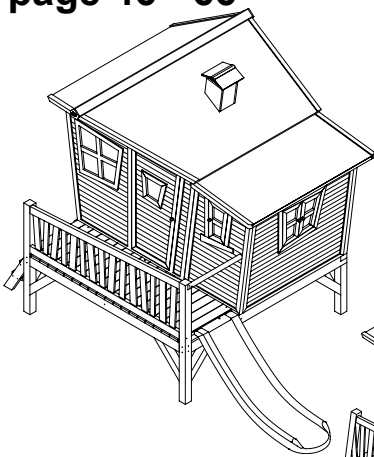

Lisa
 page 31 - 45

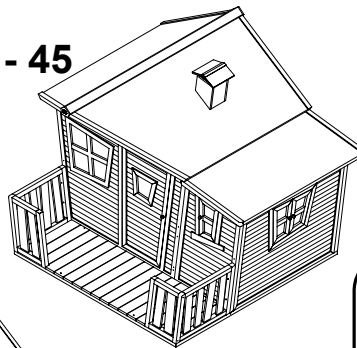

Max
 page 66 - 86

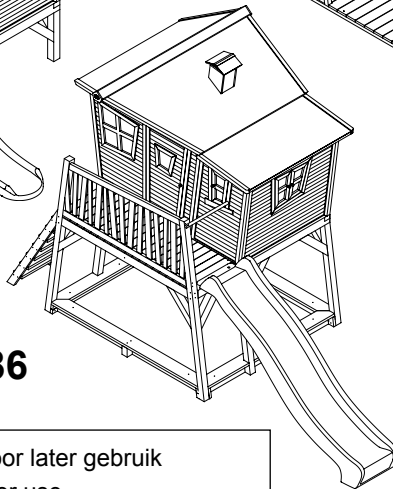

AXI 04

AXI 05

patented product

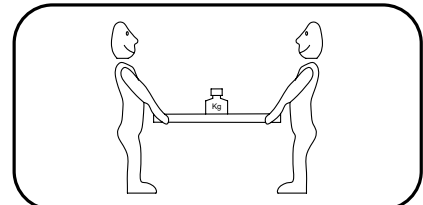
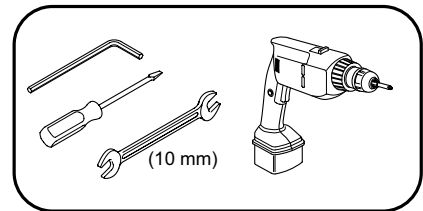

Handleiding bewaren voor later gebruik
 Keep instructions for later use
 Anleitung zum späteren Gebrauch aufbewahren
 Conserver la notice pour usage ultérieur
 Guardar estas Instrucciones para su uso future
 Conservare l'istruzioni per uso successivo

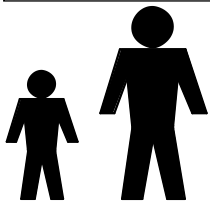

WARNING

CHOKING HAZARD
 small parts

Not suitable for children under
 36 months



WARNING

**THE TOY IS TO BE ASSEMBLED BY
 AN ADULT.**



WARNING

Potential hazard description, e.g. In
 unassembled state contain potentially
 hazardous sharp points, so please
 keep out of baby's reach

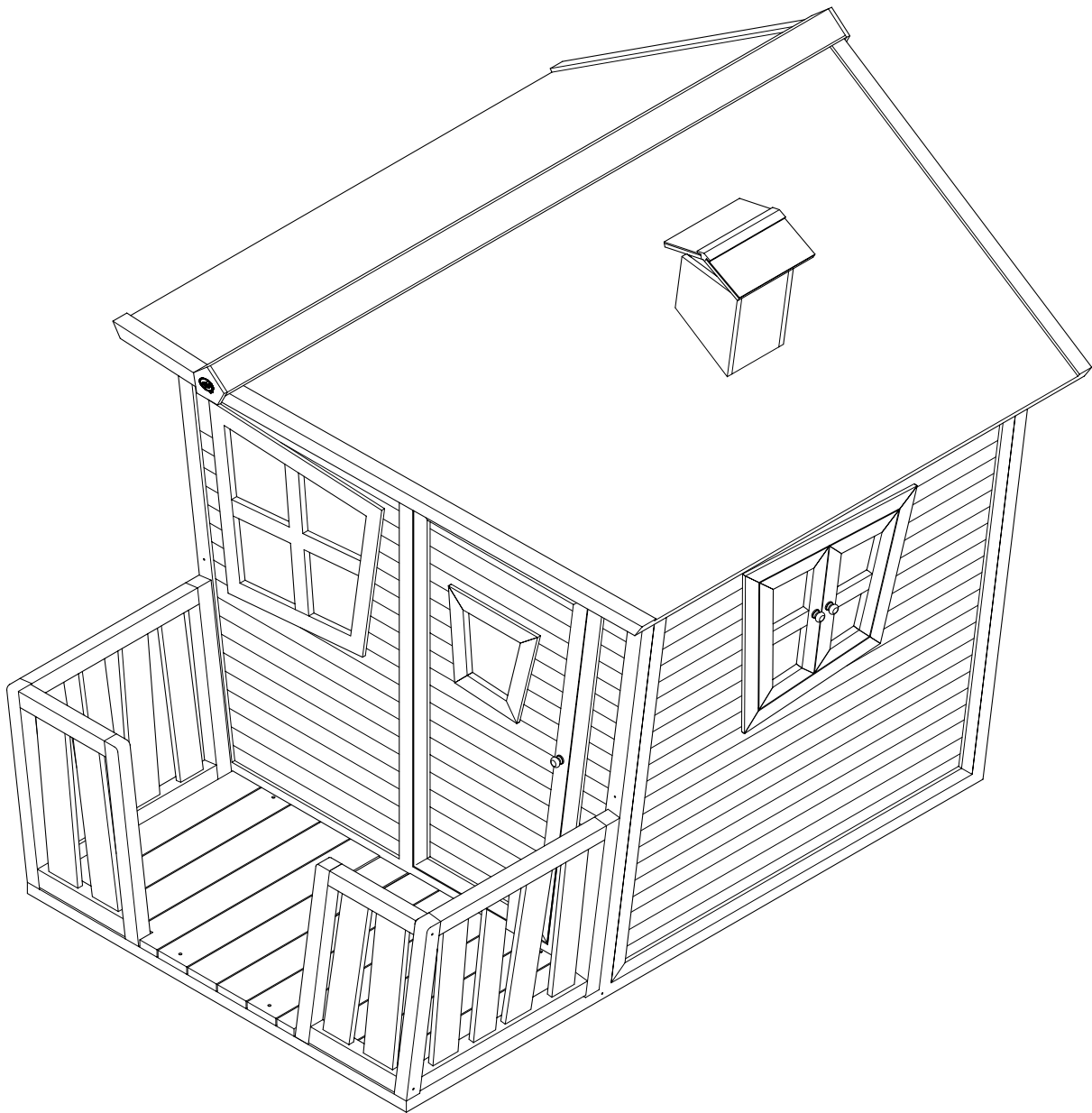



Jesse

A030.111.XX

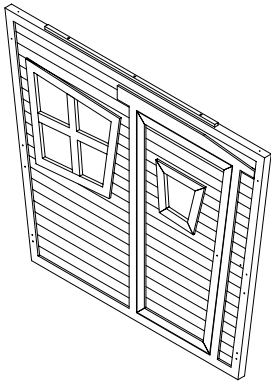

1

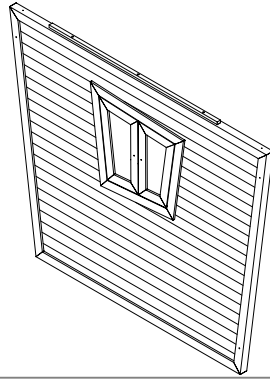

3

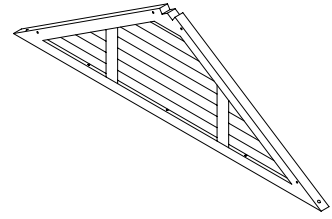

5

2x



4

14x

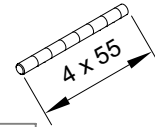

t1

7x

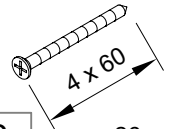

s2

26x

A030.112.XX

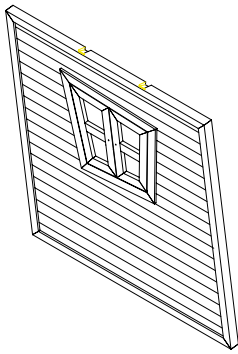

2

2x

A030.113.XX

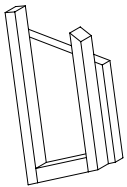

16

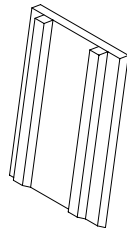

17

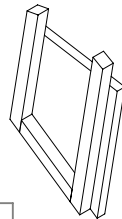

18

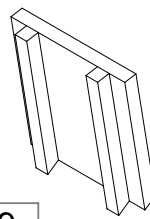

19

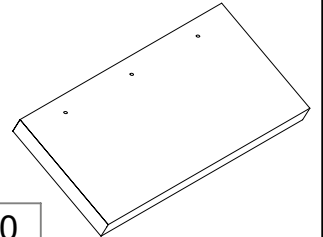

20

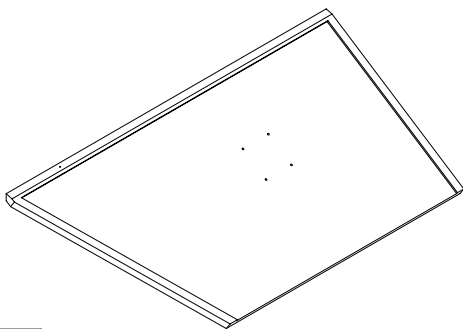

21

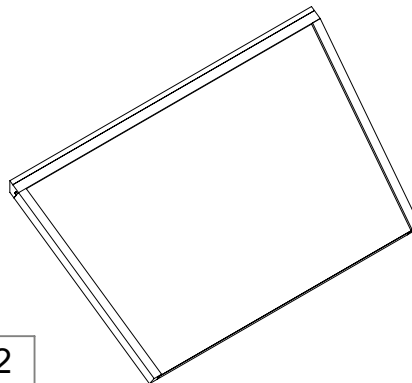

22

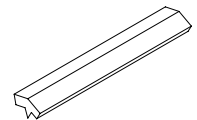

20A

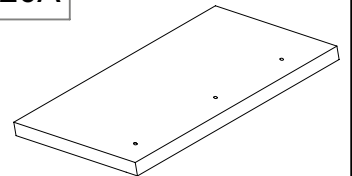

20

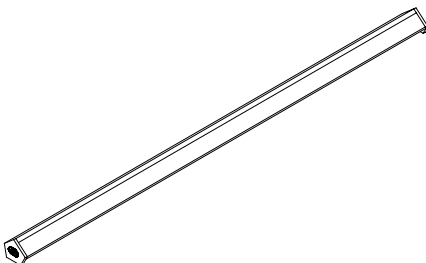

23

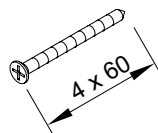

s2

8x

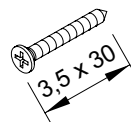

s3

16x

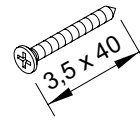

s4

15x

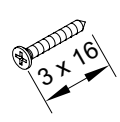

s6

64



Jesse

A030.114.XX

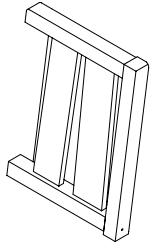

6

2x

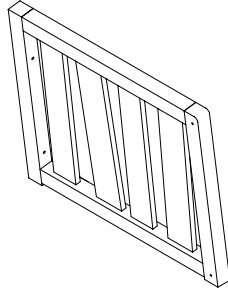

7

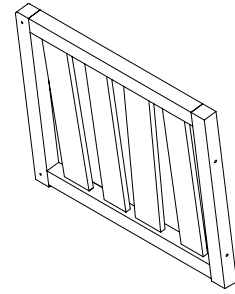

8

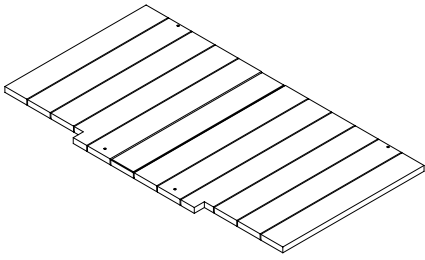

9

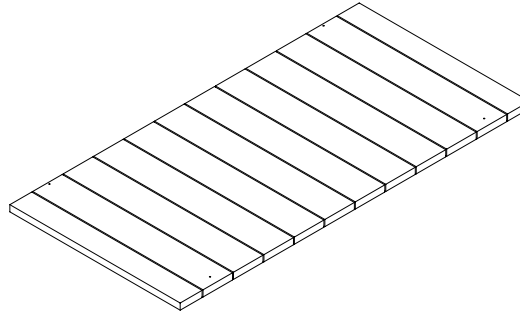

15

s2

12x

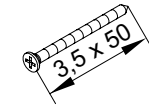
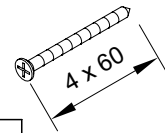

s1

2x

12x

A030.141.XX

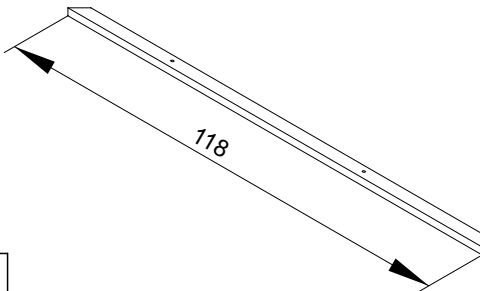

1

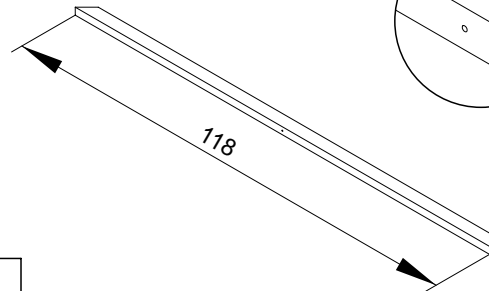

2

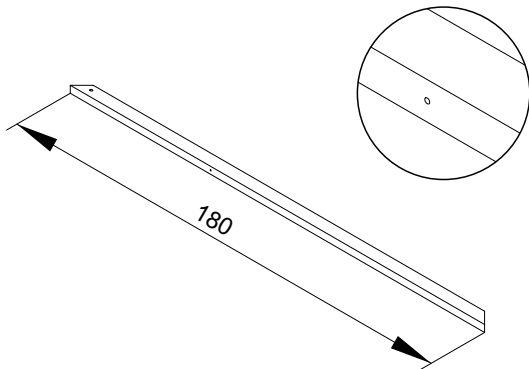

3

2x

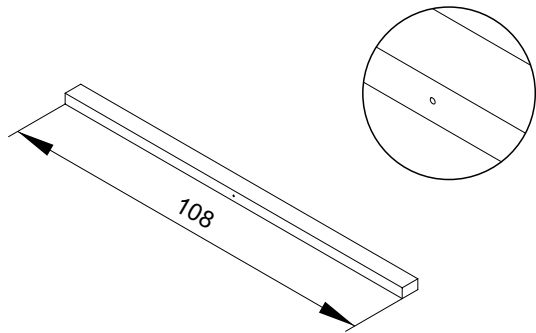

4

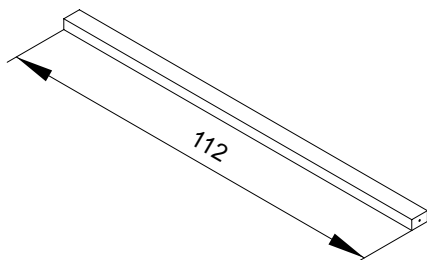

5

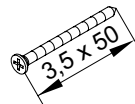

s1

8x

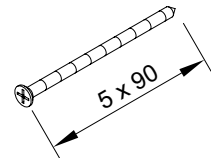

s5

4x5



Jesse

1	2	3	2x	4	5	s1	8x	s5	4x

A030.141.XX

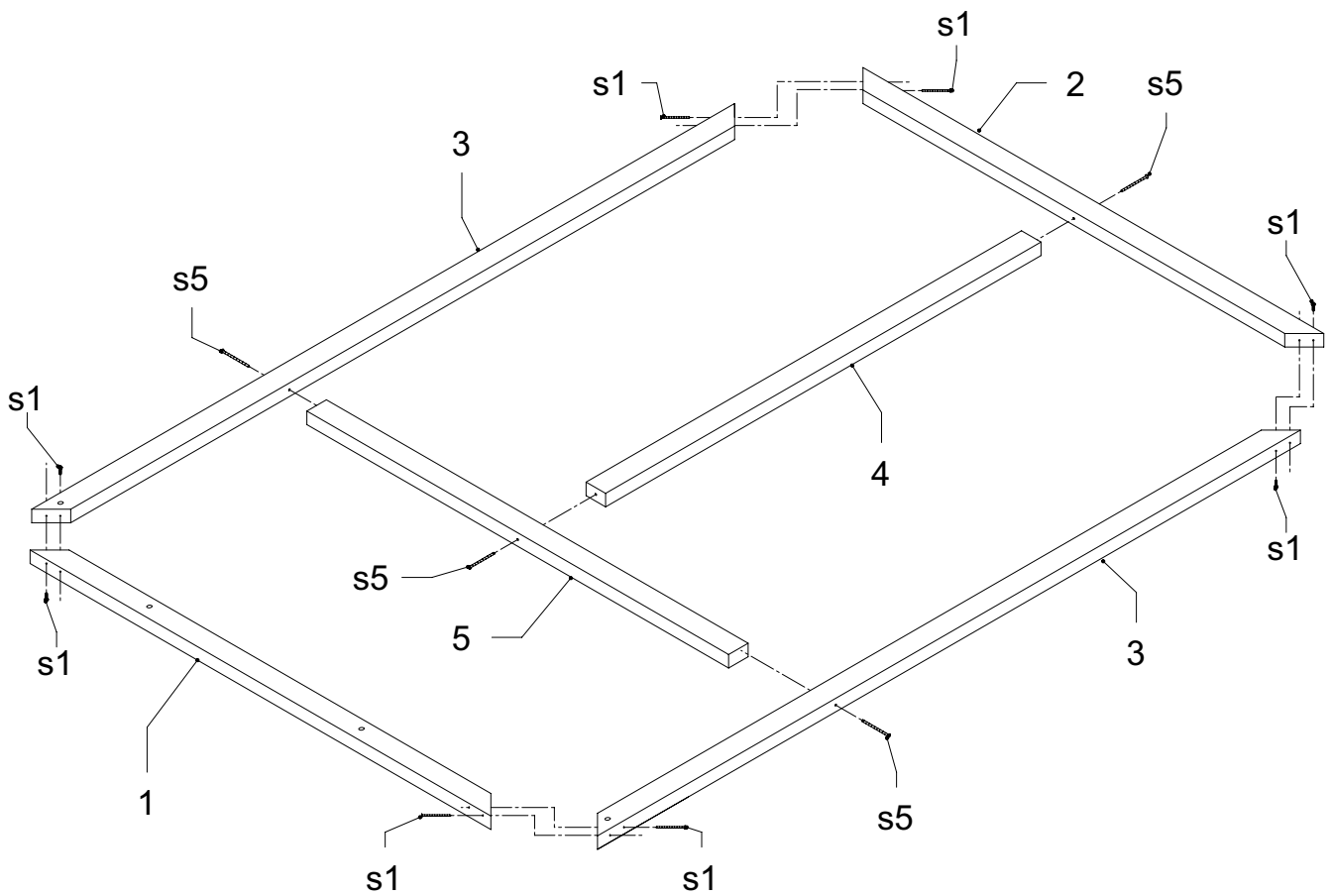



Jesse

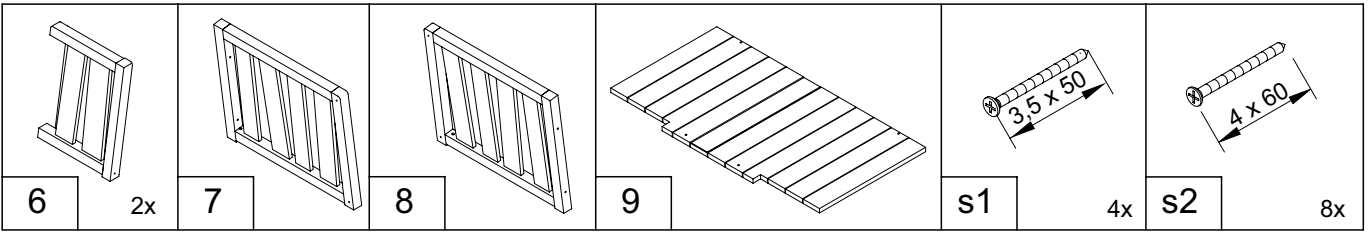

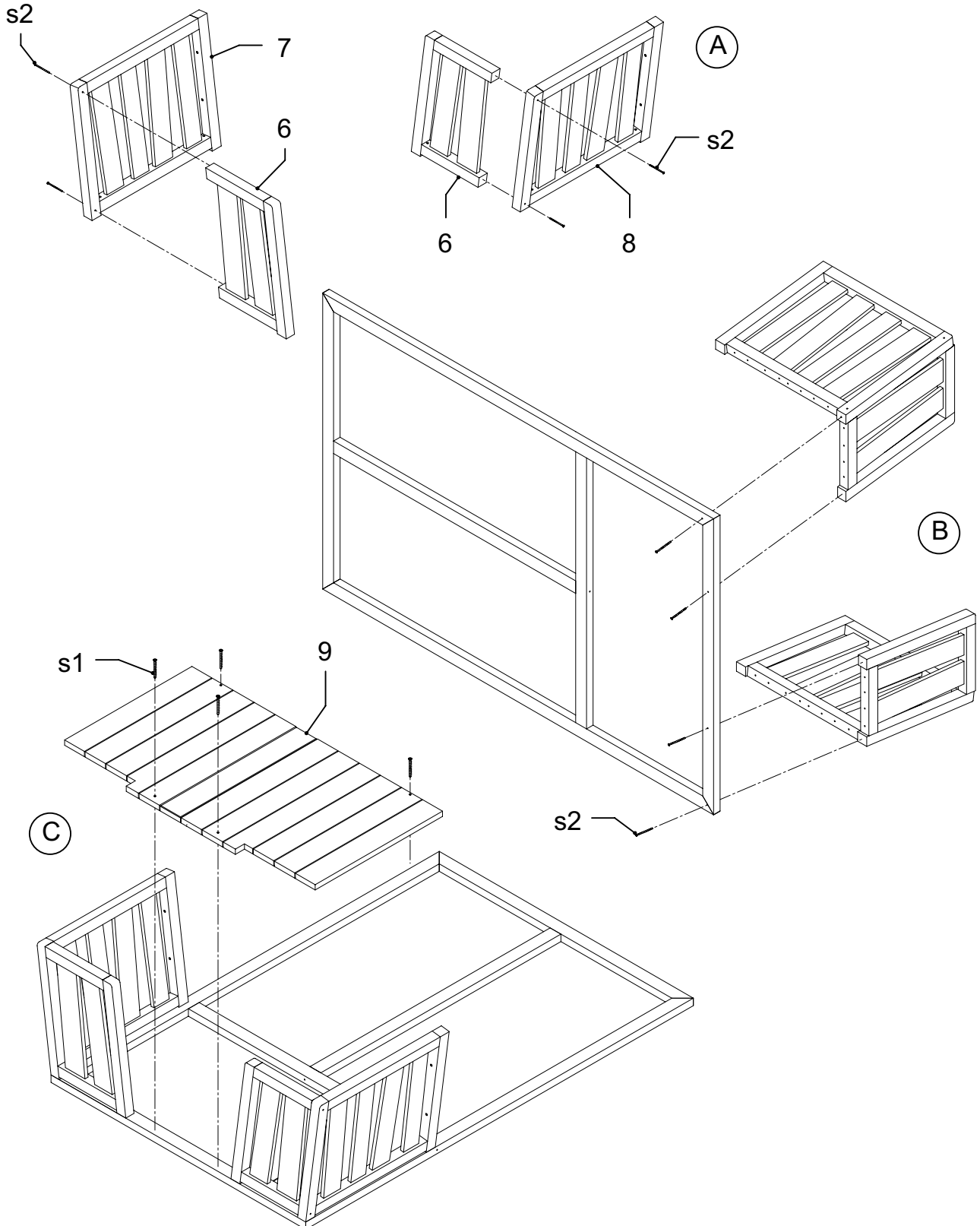

A030.114.XX



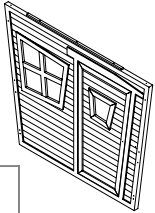
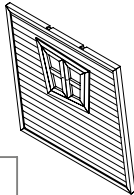
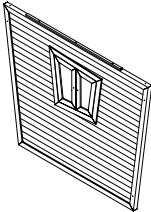

Jesse

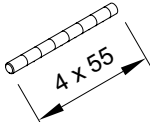
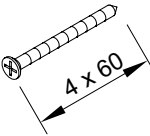
		2x			14x		7x		16x
10	11		12	13		t1		s2	

A030.111.XX + A030.112.XX

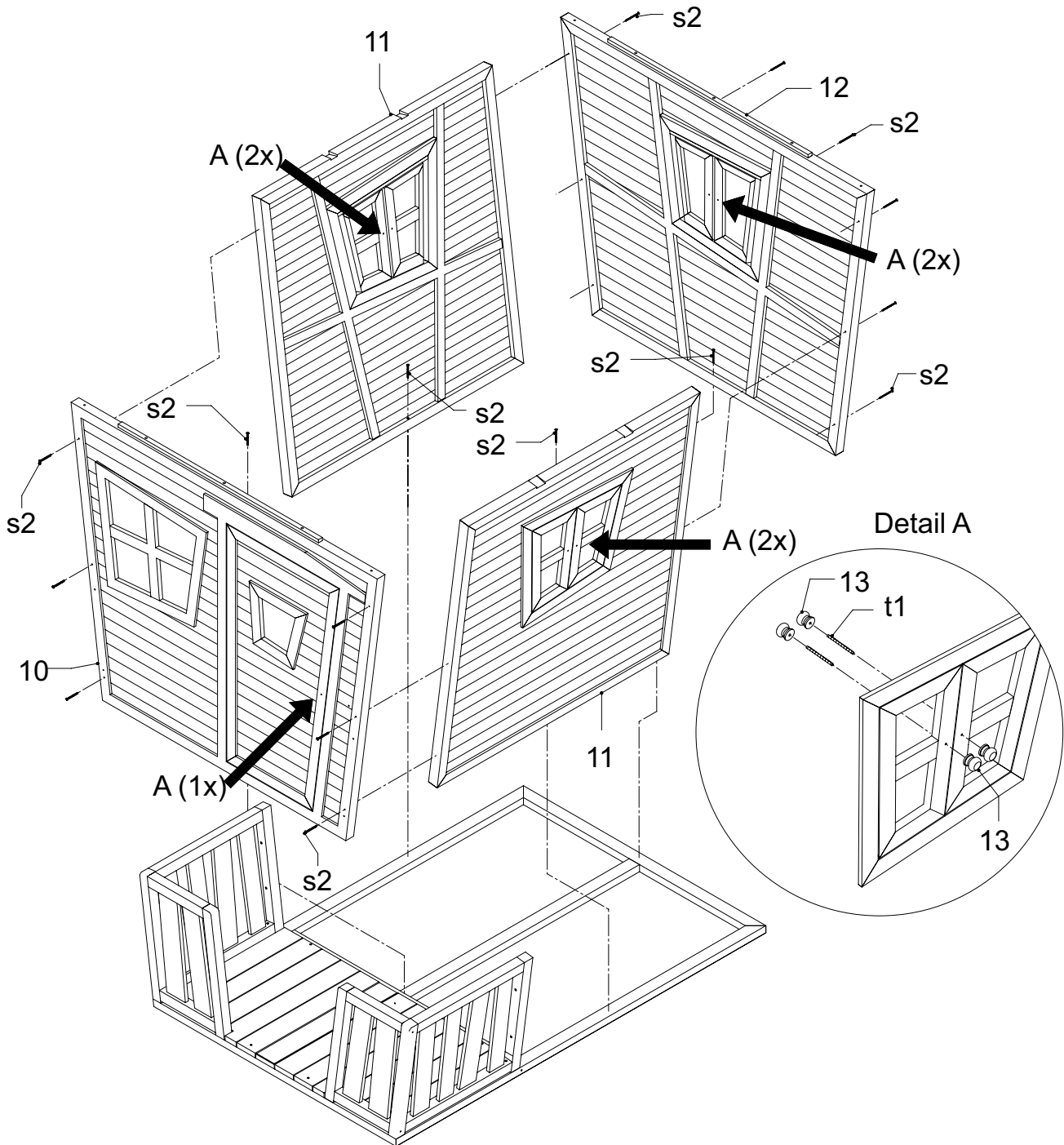

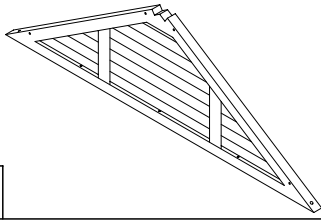

2x

s2

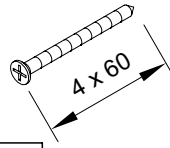

14x

14

A030.111.XX + A030.114.XX

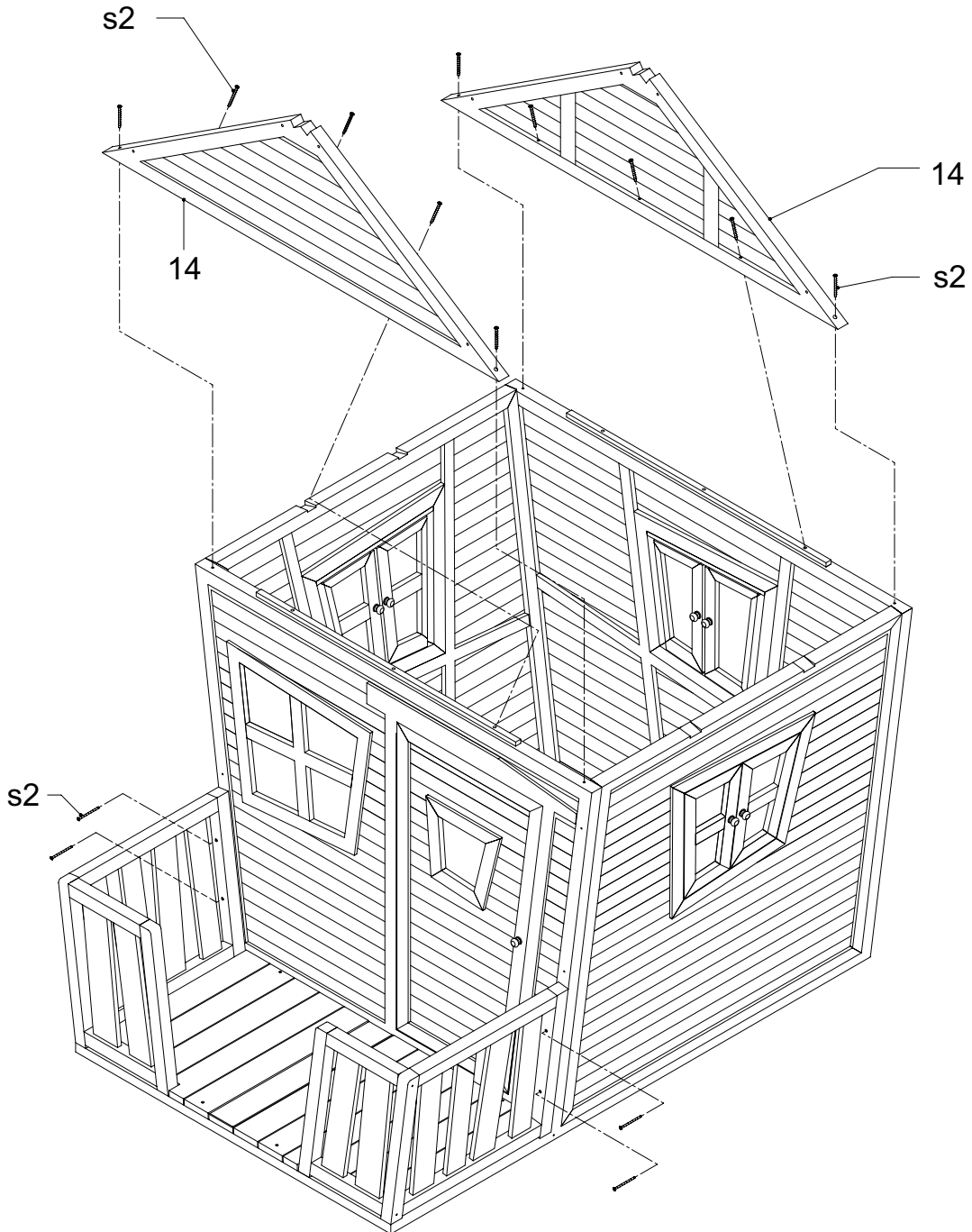

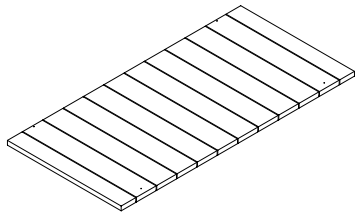

15

2x

S1

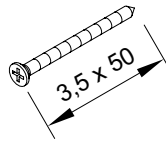

8x

A030.114.XX

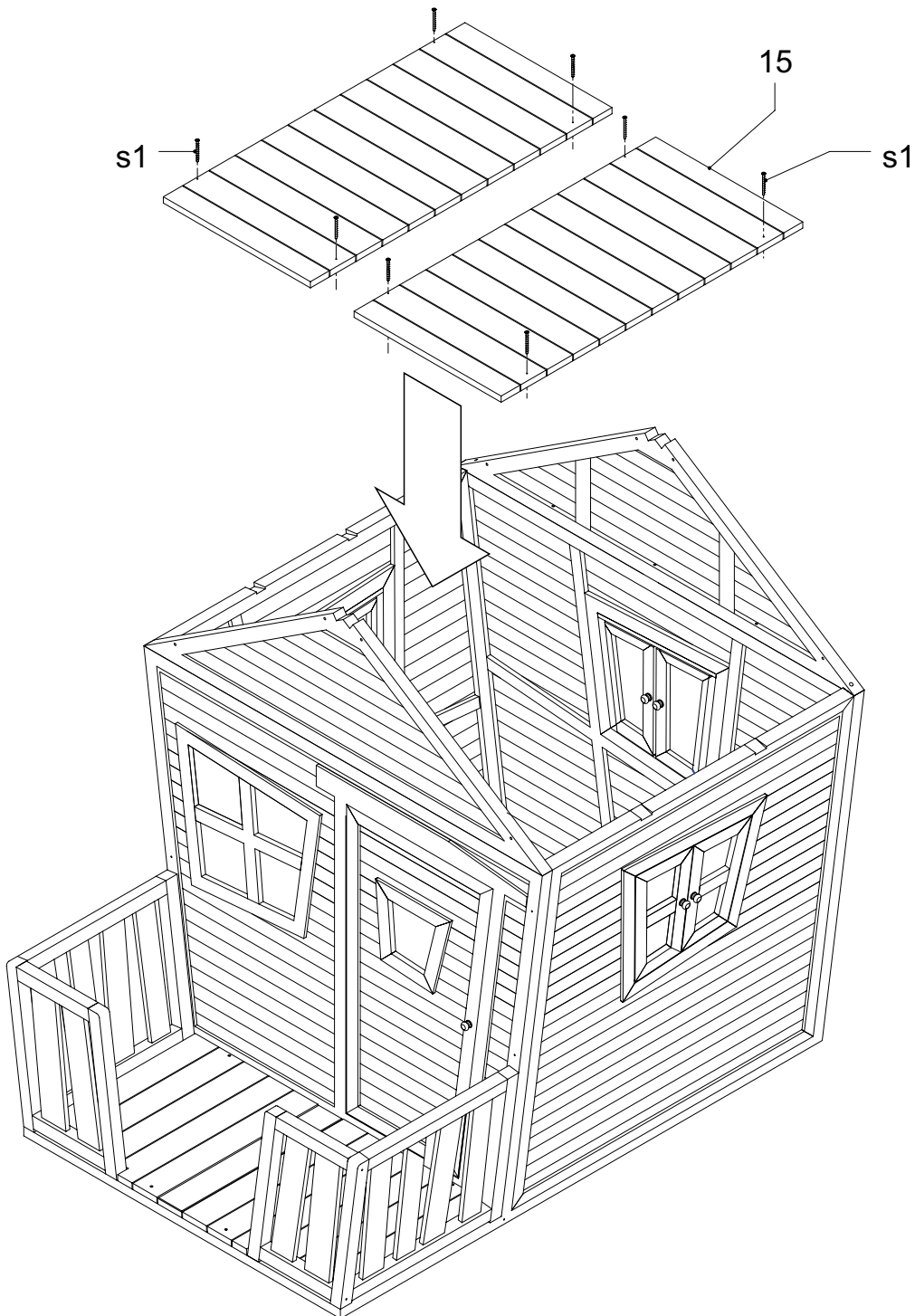



Jesse

16	17	18	19	20	20A	20B	21	s3 16x	s6 6x

A030.114.XX

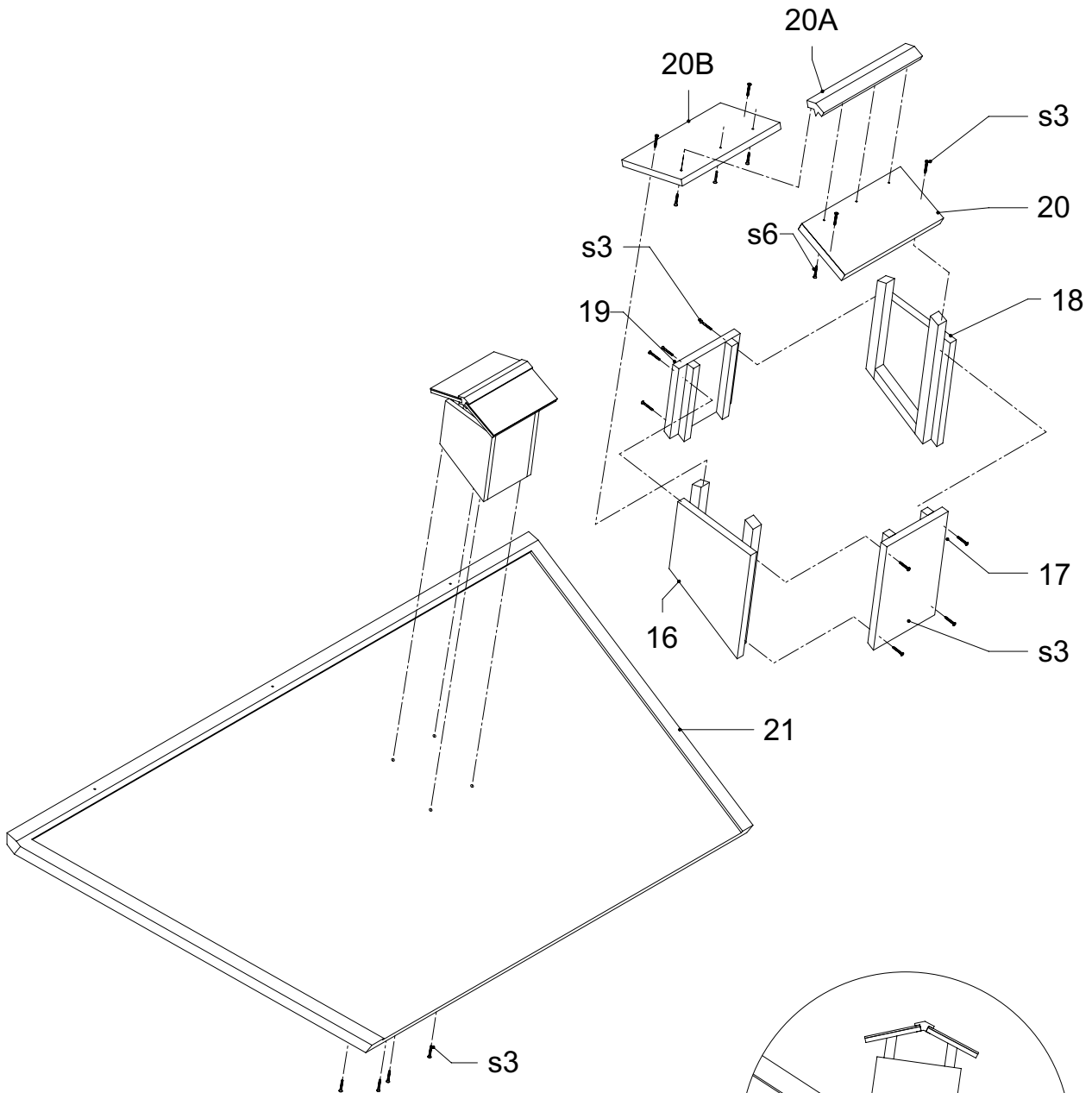

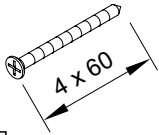

s2

4x

A030.113.XX

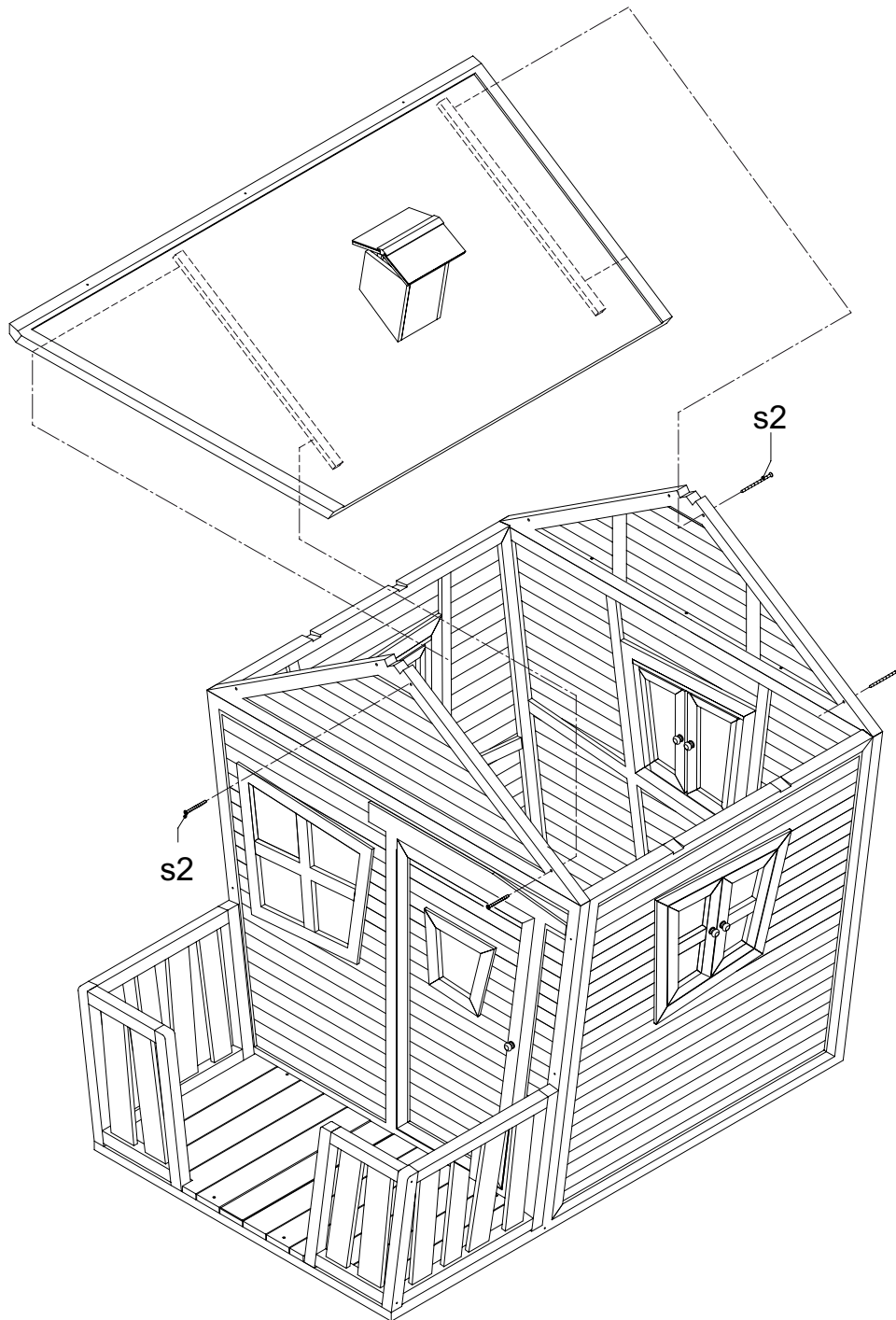

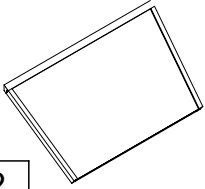

22

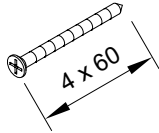

s2

4x

A030.113.XX

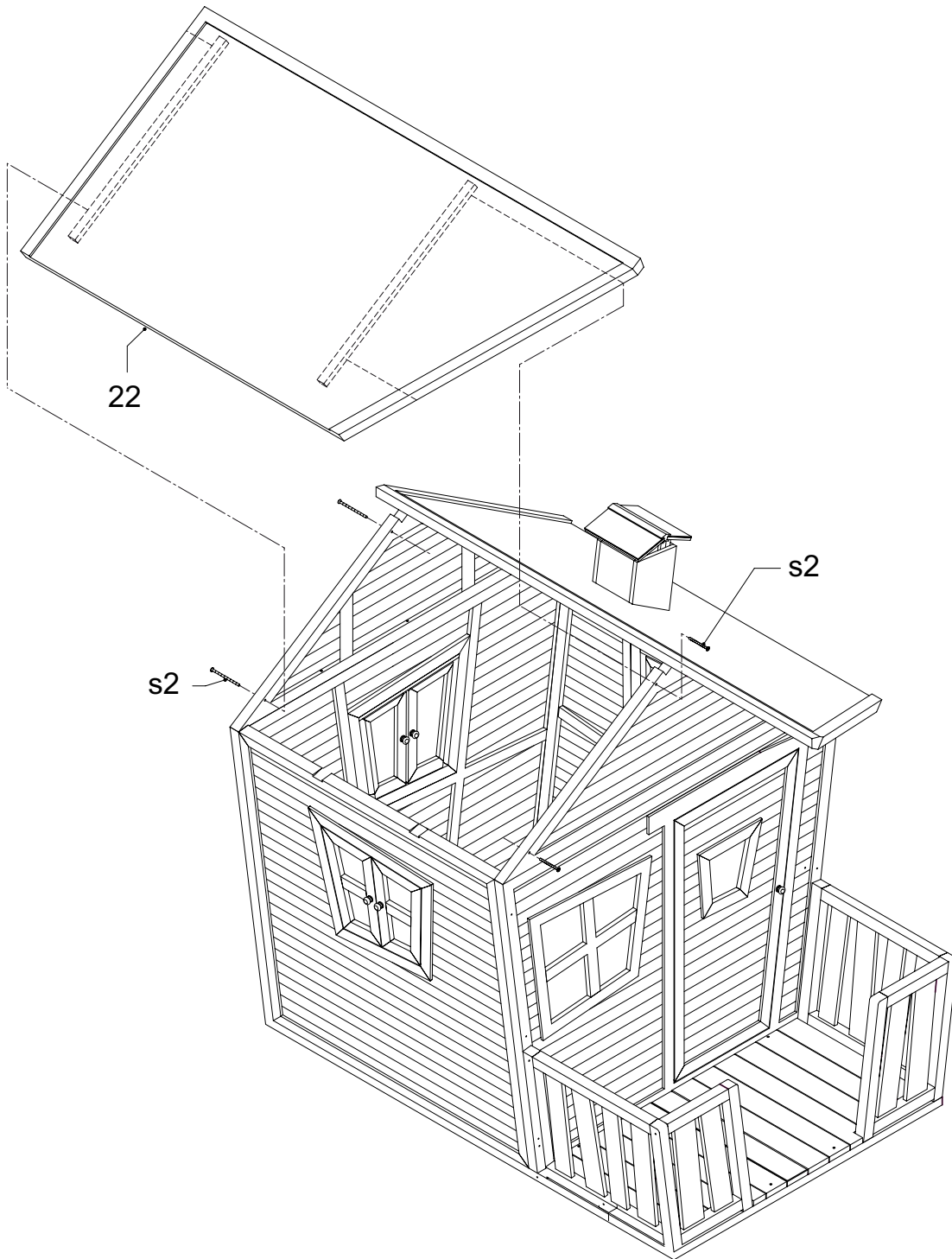

s2

s2

22



23

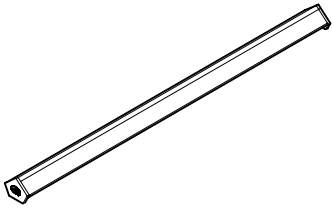

s4

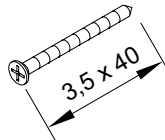

15x

A030.113.XX

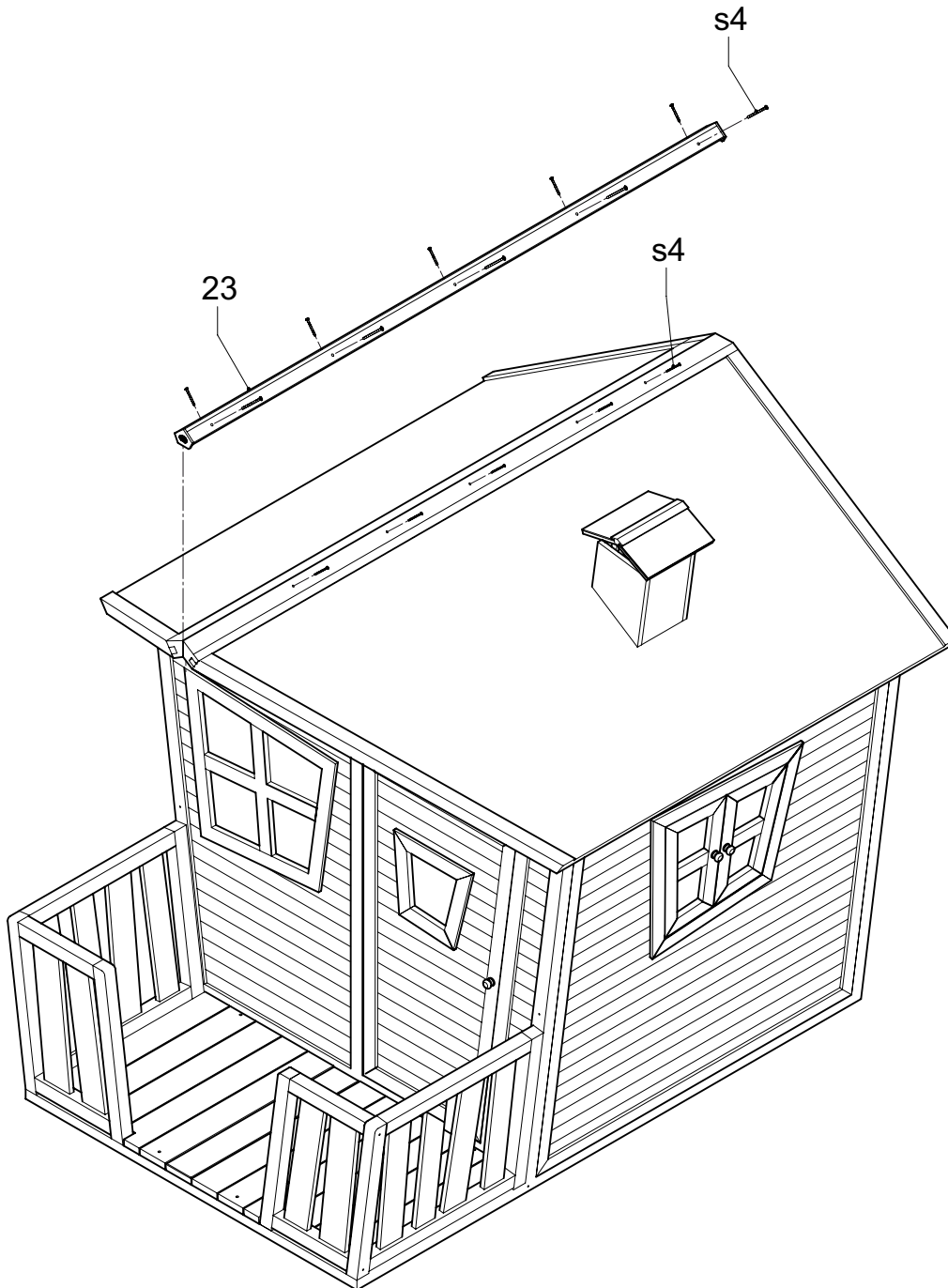



Iris

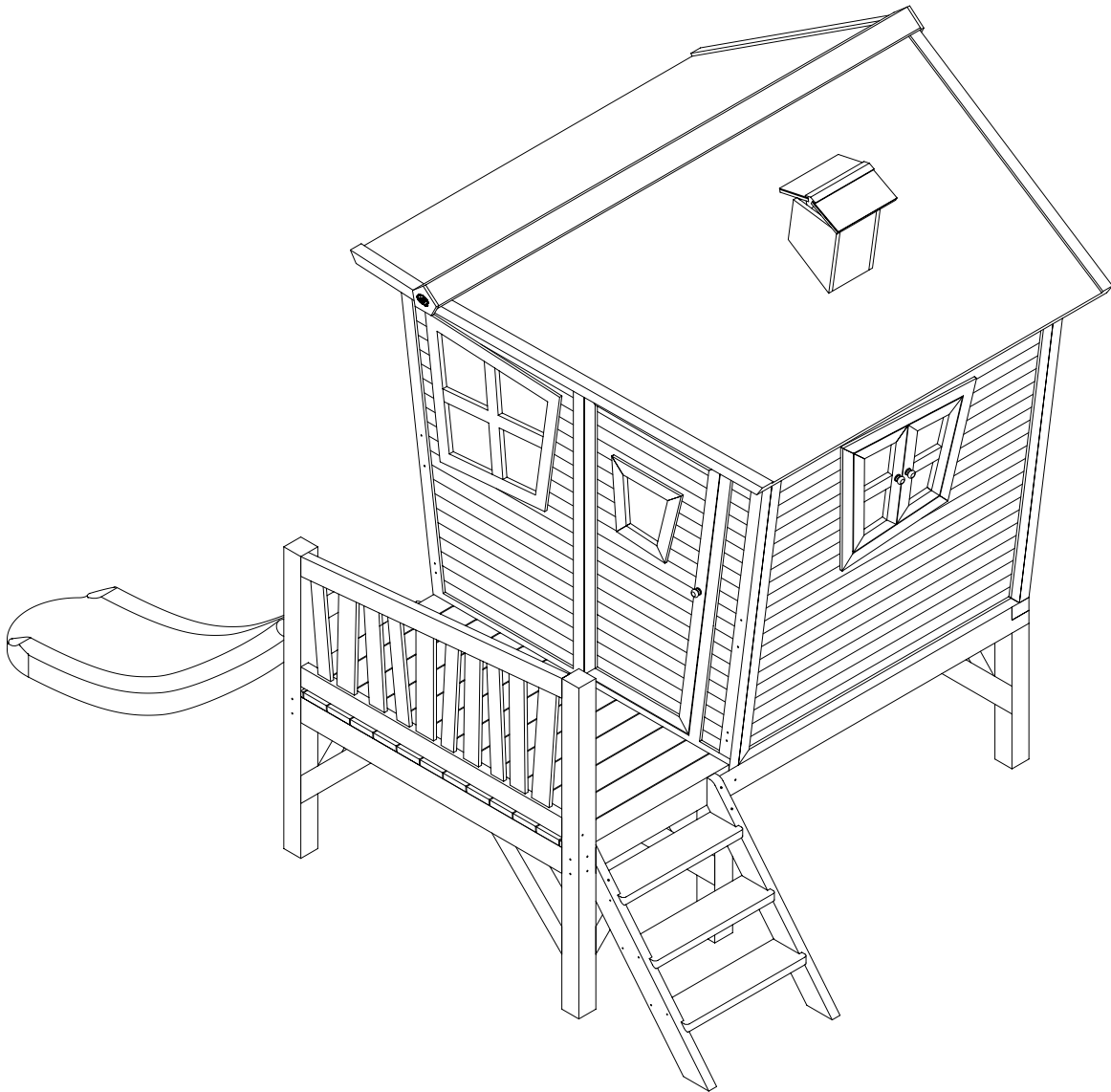



Iris

A030.111.XX

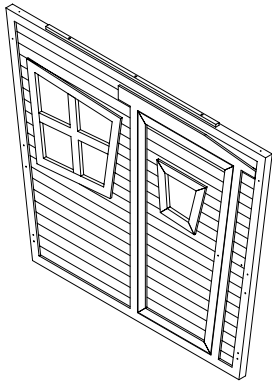

1

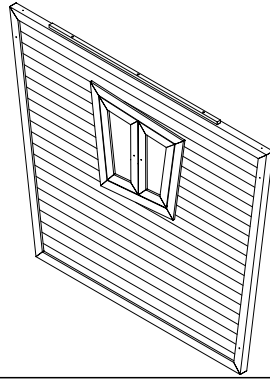

3

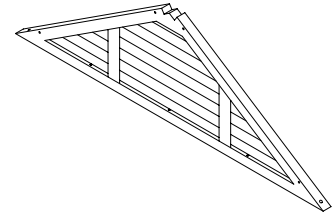

5

2x



4

14x

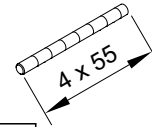

t1

7x

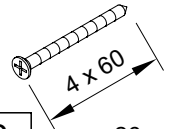

s2

26x

A030.112.XX

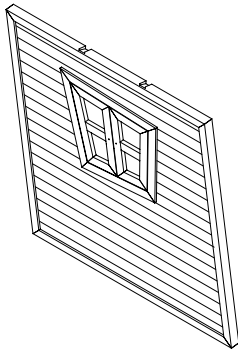

2

2x

A030.113.XX

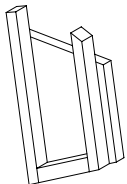

7

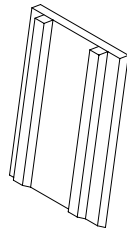

8

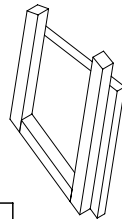

9

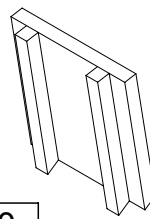

10

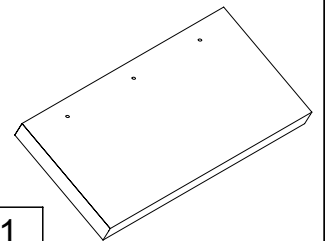

11

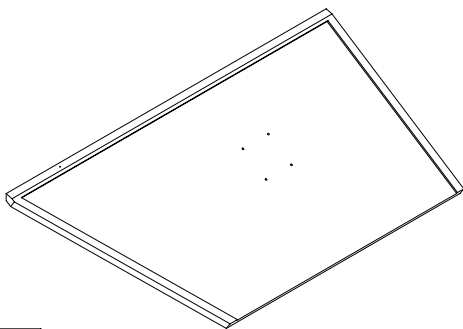

12

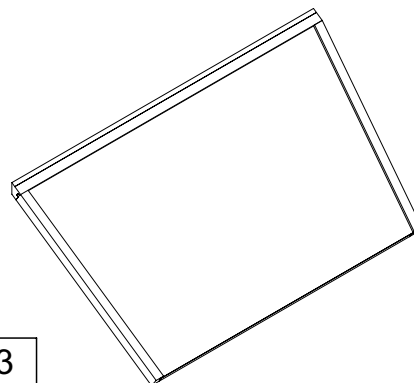

13

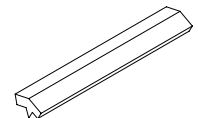

11A

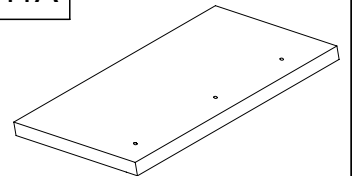

11B

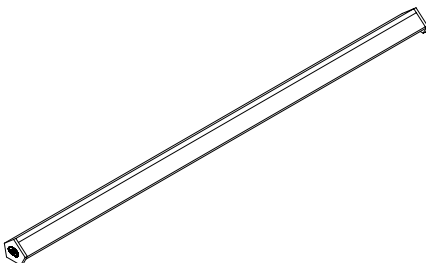

14

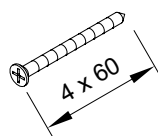

s2

8x

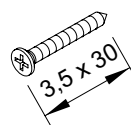

s3

16x

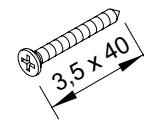

s4

15x



s6

6x



Iris

A030.115.XX

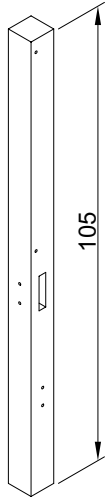

16

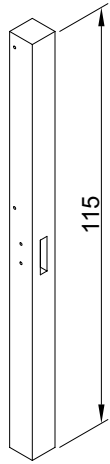

17

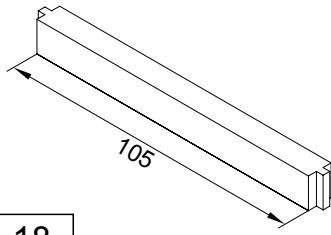

18

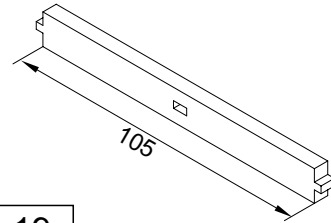

19

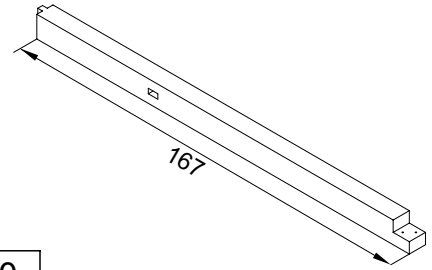

20

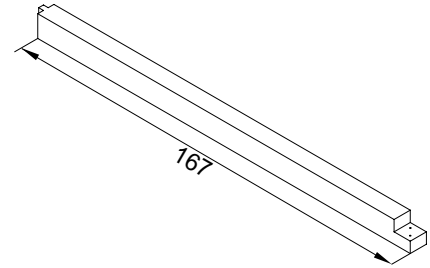

21

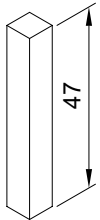

22

2x

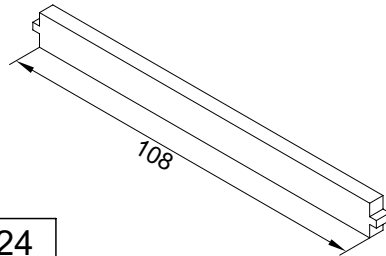

24

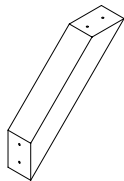

23

8x

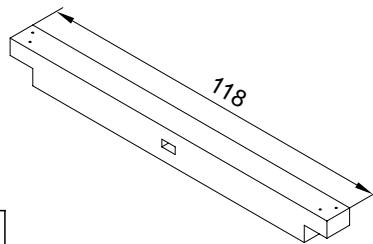

25

s1

14x

s2

16x

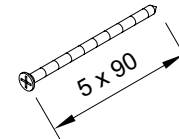
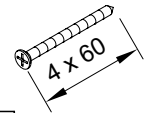
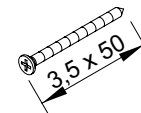

s5

40x

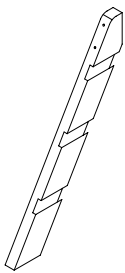

29

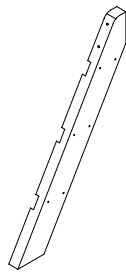

30

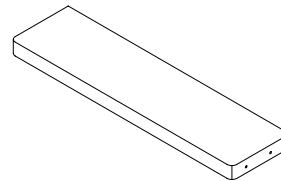

31

3x

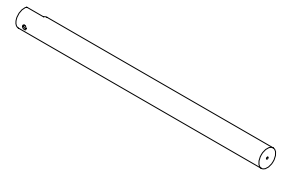

32

A030.116.XX

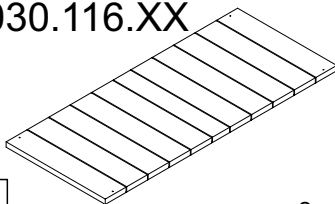

6

2x

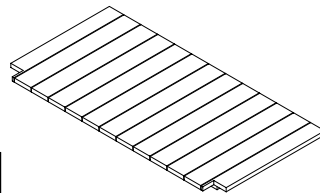

26

s7

4x

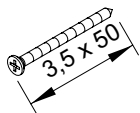
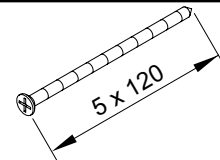

s1

12x

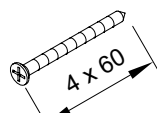

s2

2x

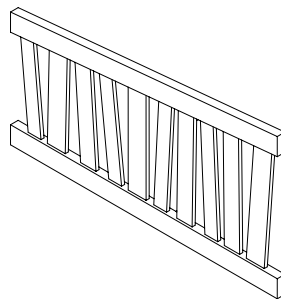

27

A039.060.XX

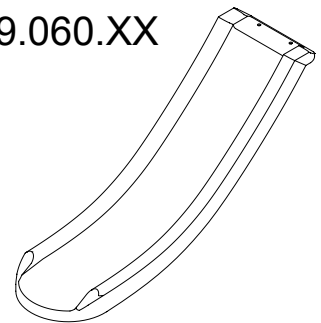

28

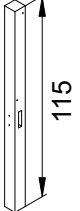
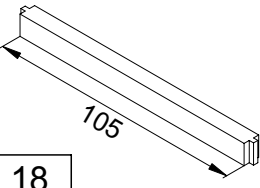
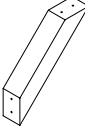
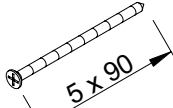
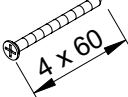

Iris

						
16	17	18	23	2x s5	8x s2	4x

A030.115.XX

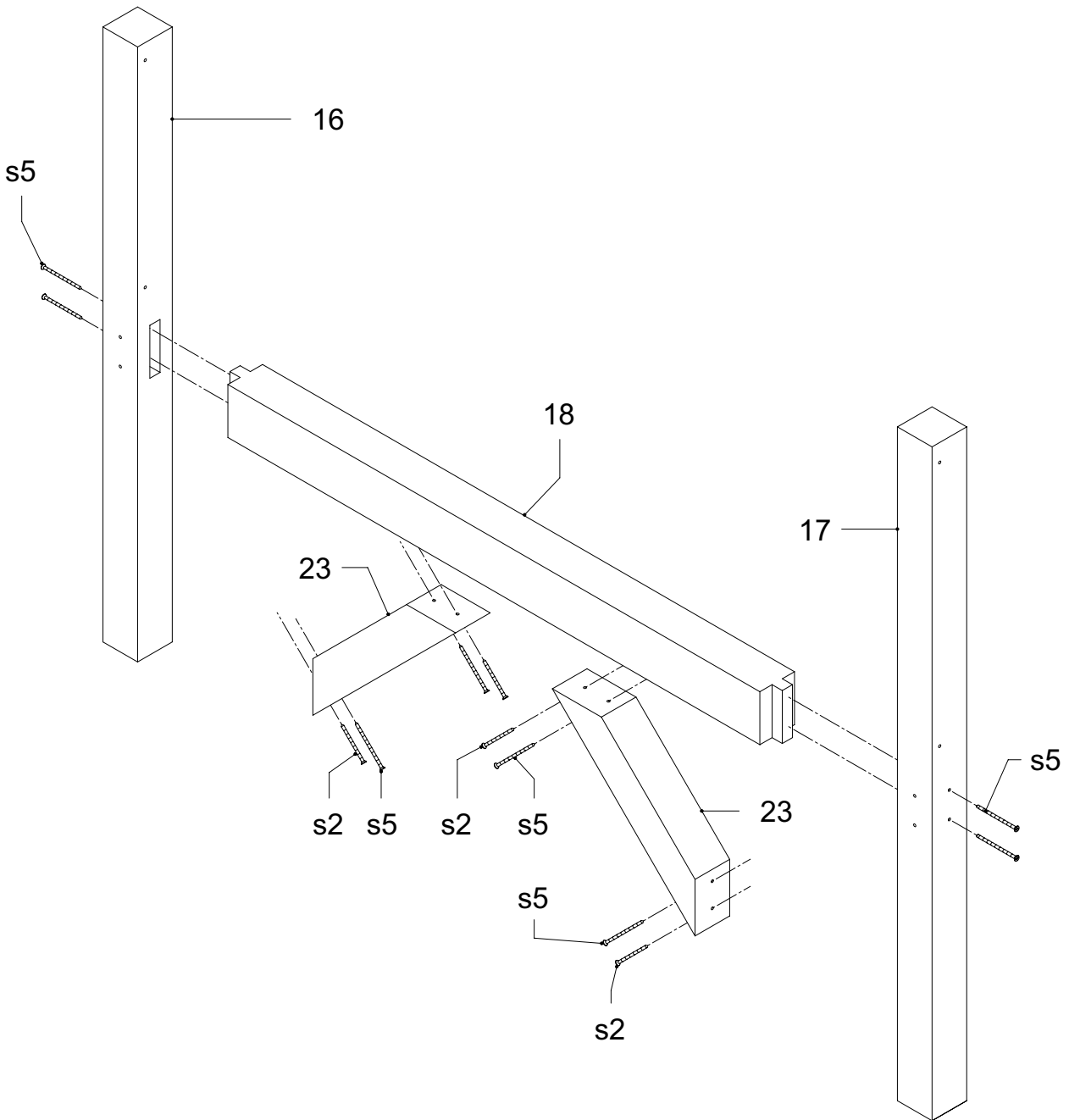



Iris

 19	 20	 22	1x	 23	2x	 s5	9x	 s2	4x
--------	--------	--------	----	--------	----	--------	----	--------	----

A030.115.XX

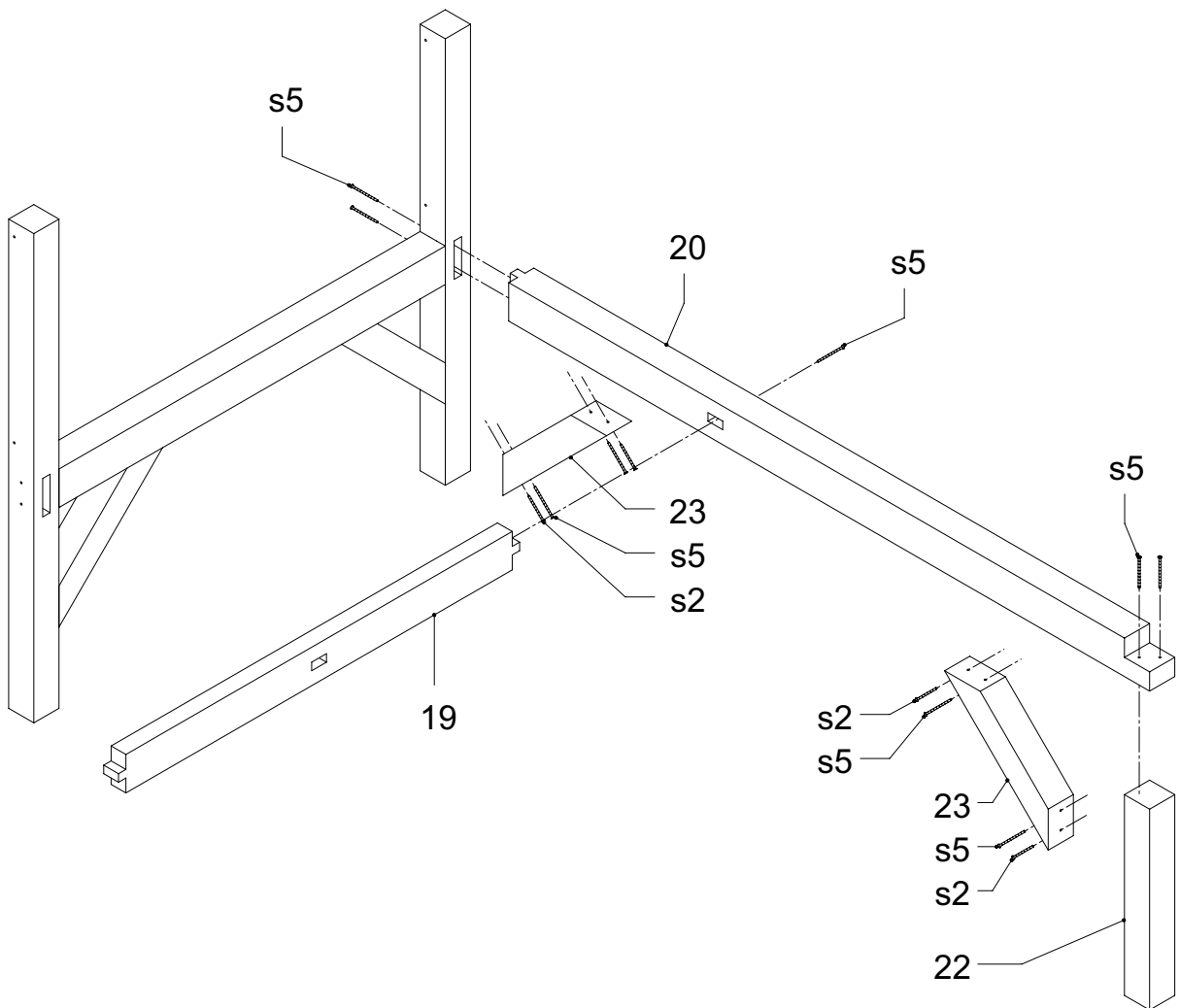



Iris

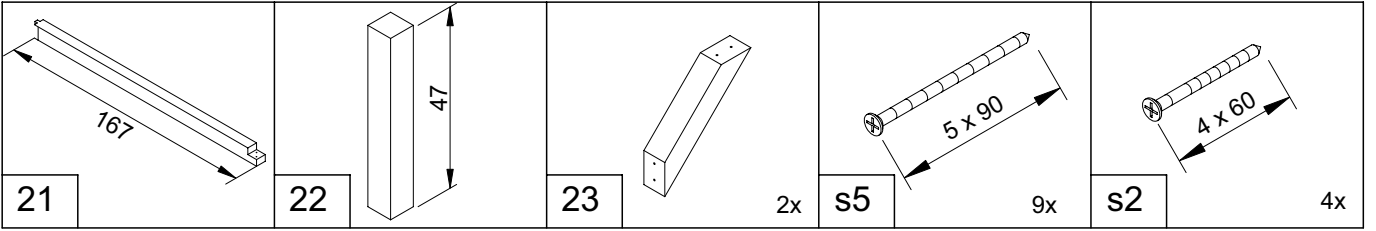

A030.115.XX

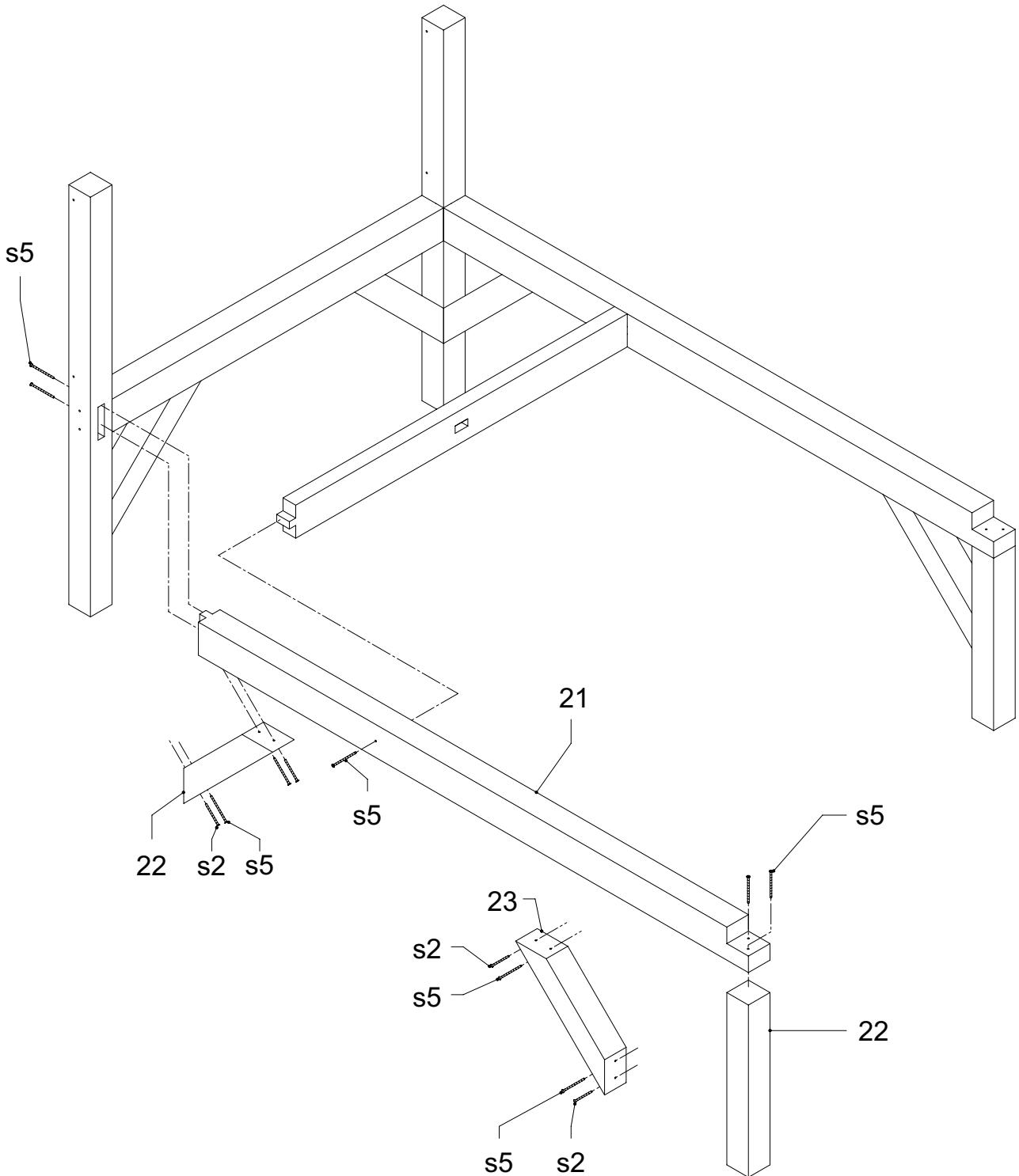



Iris

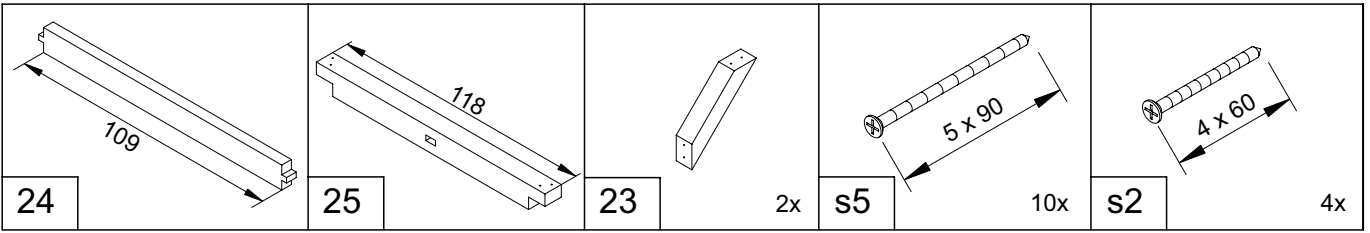

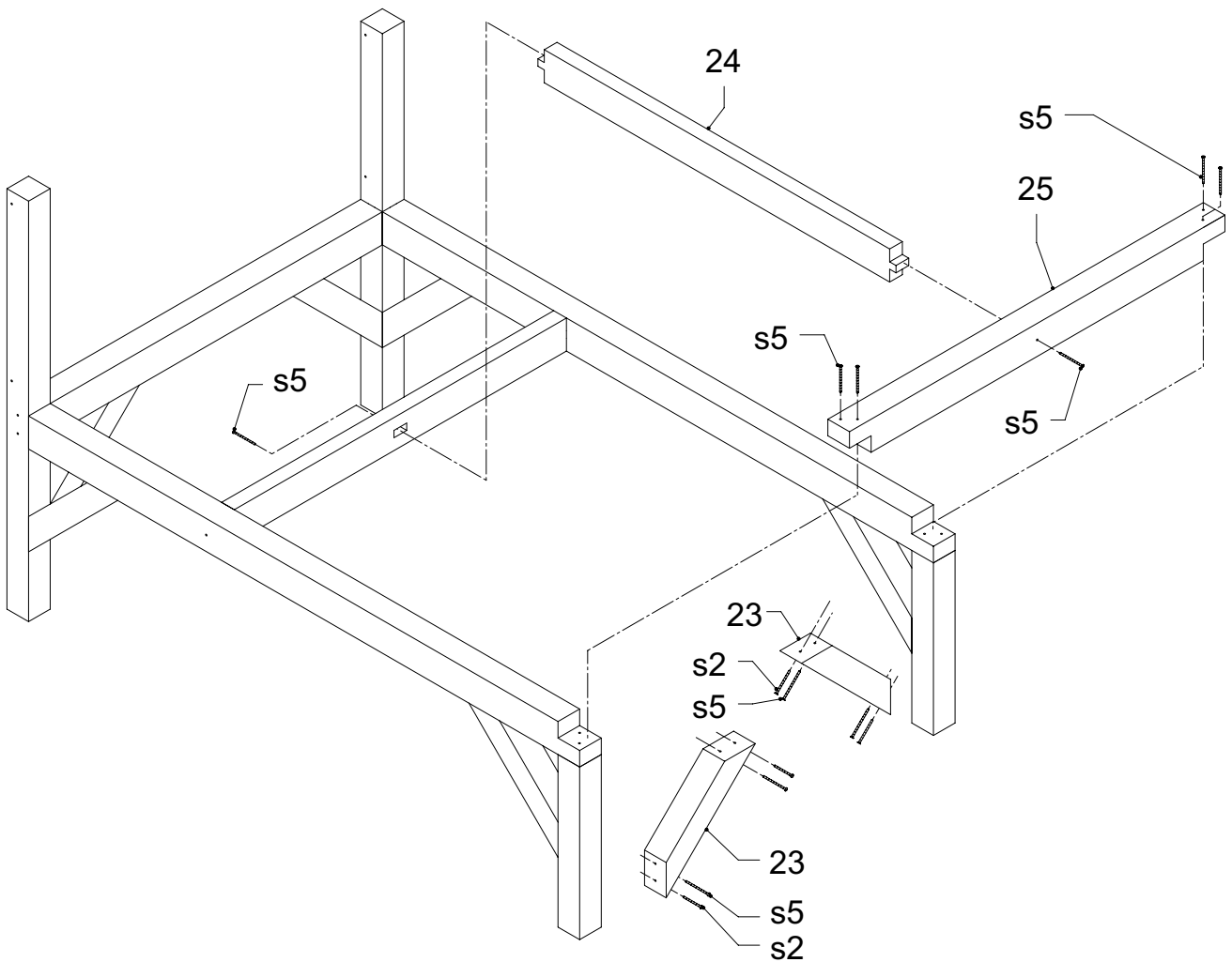

A030.115.XX



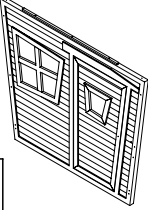
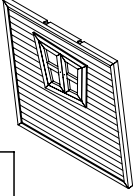
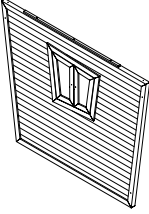

Iris

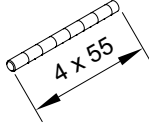
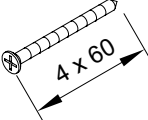
					
1	2x	3	14x	t1 7x	s2 16x

A030.111.XX + A030.112.XX

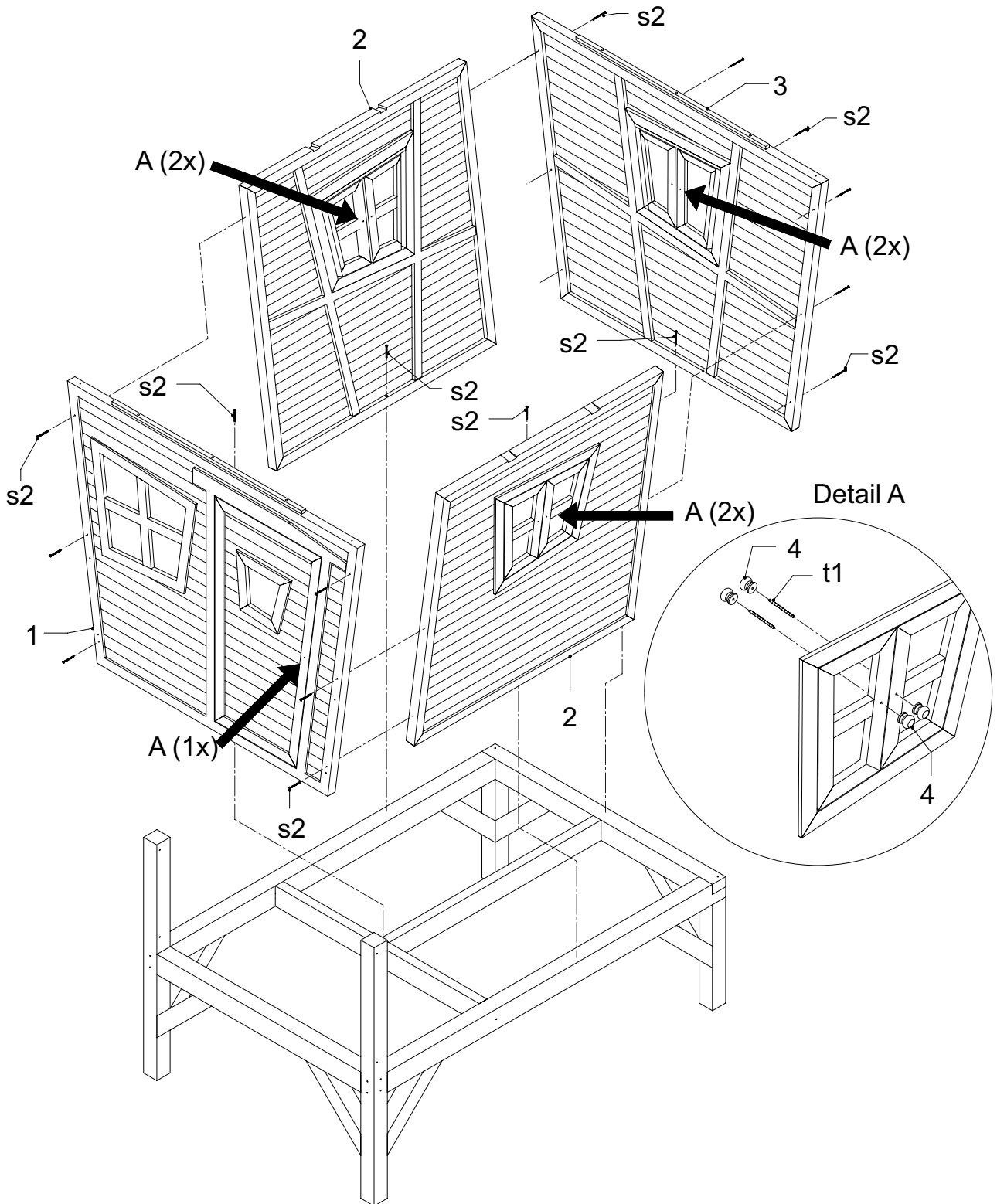



Iris

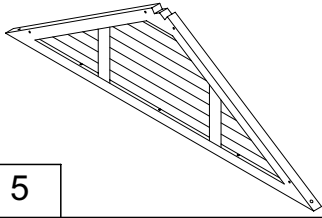

5

2x

s2

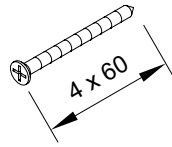

10x

A030.116.XX

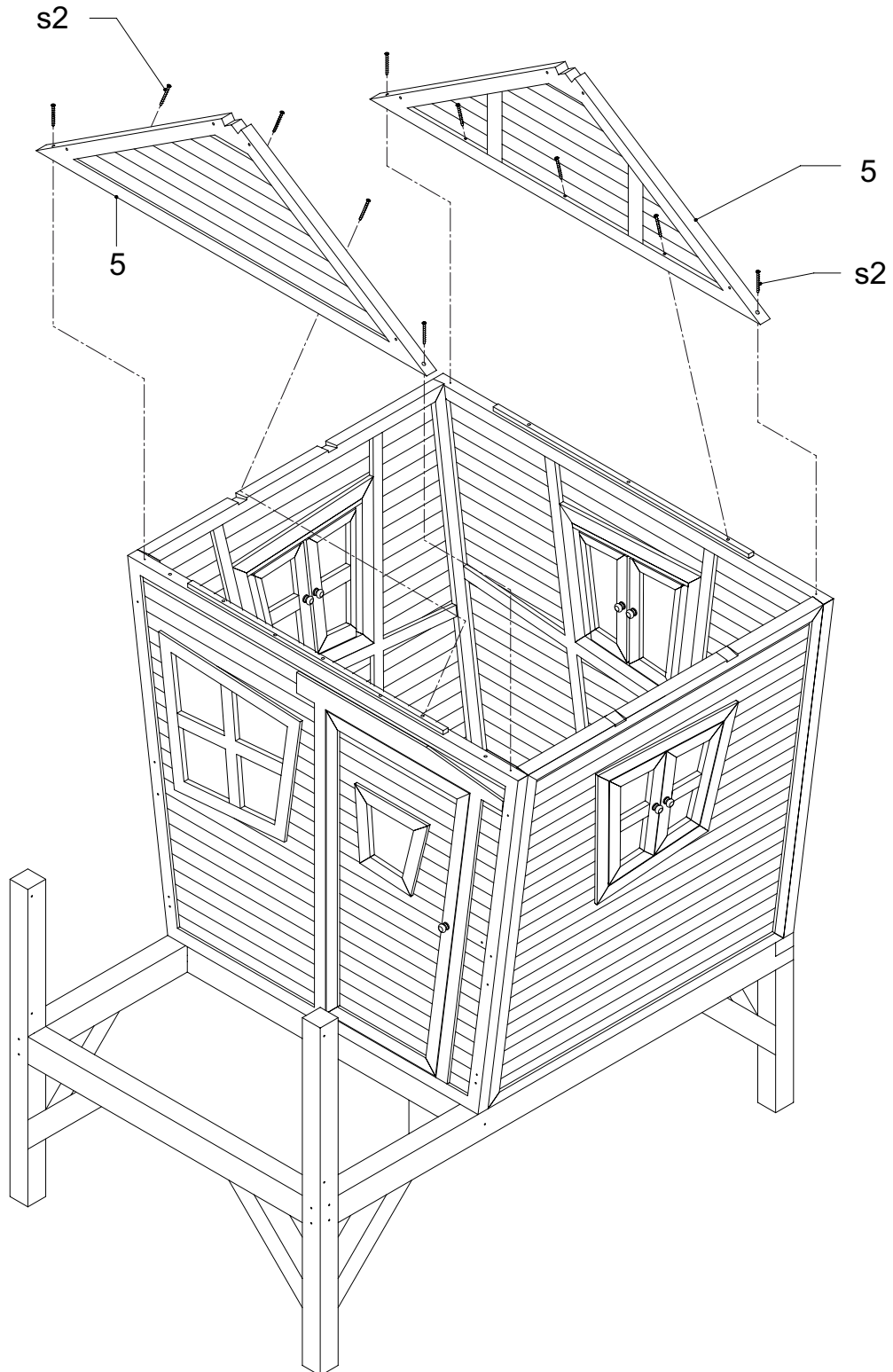

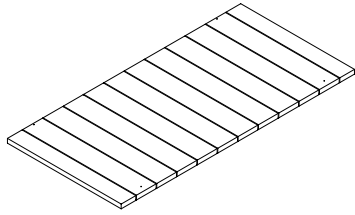

6

2x

s1

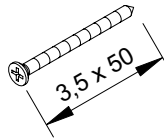

8x

A030.116.XX

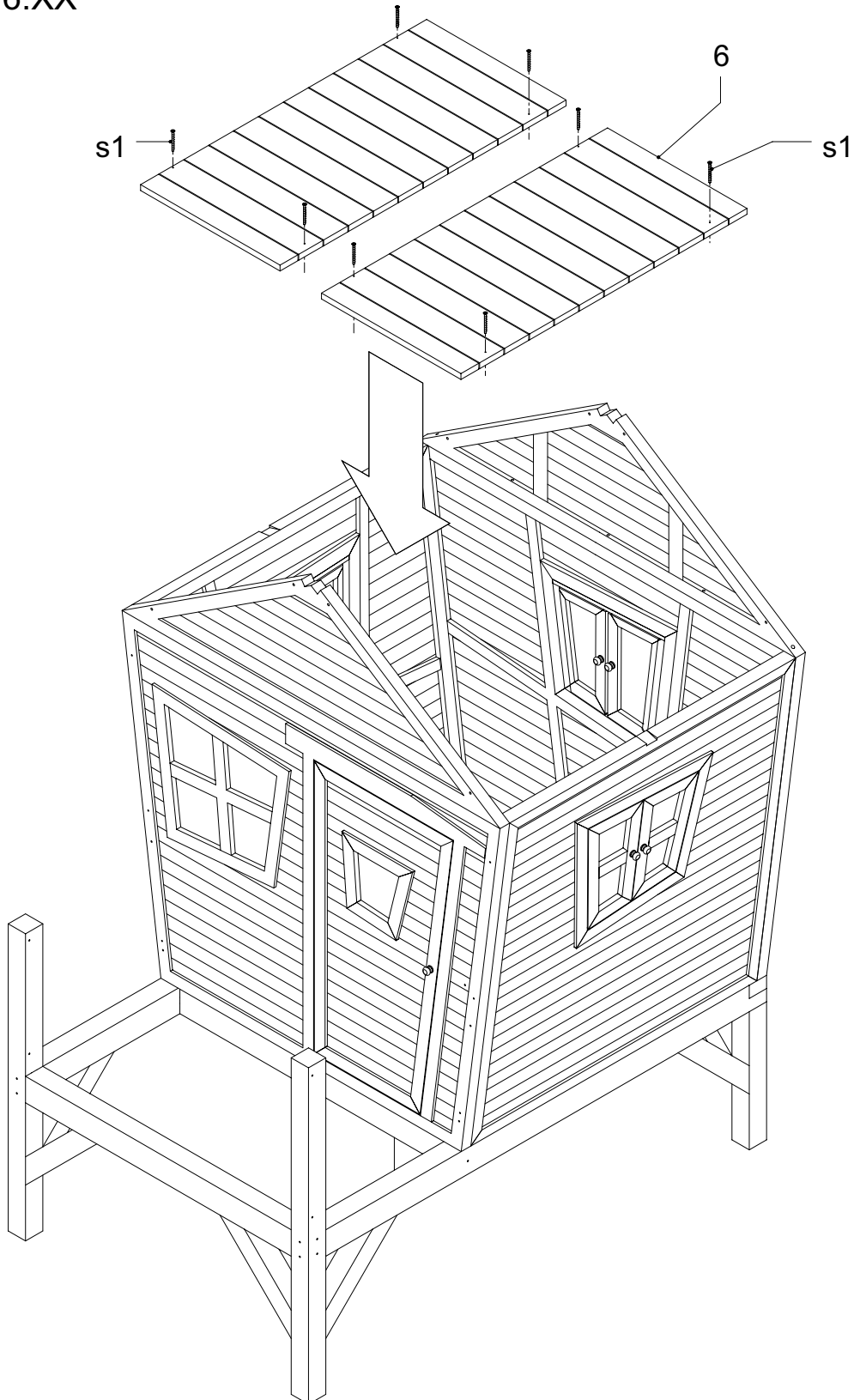



Iris

7	8	9	10	11	11A	11B	12	s3 16x	s6 6x

A030.113.XX

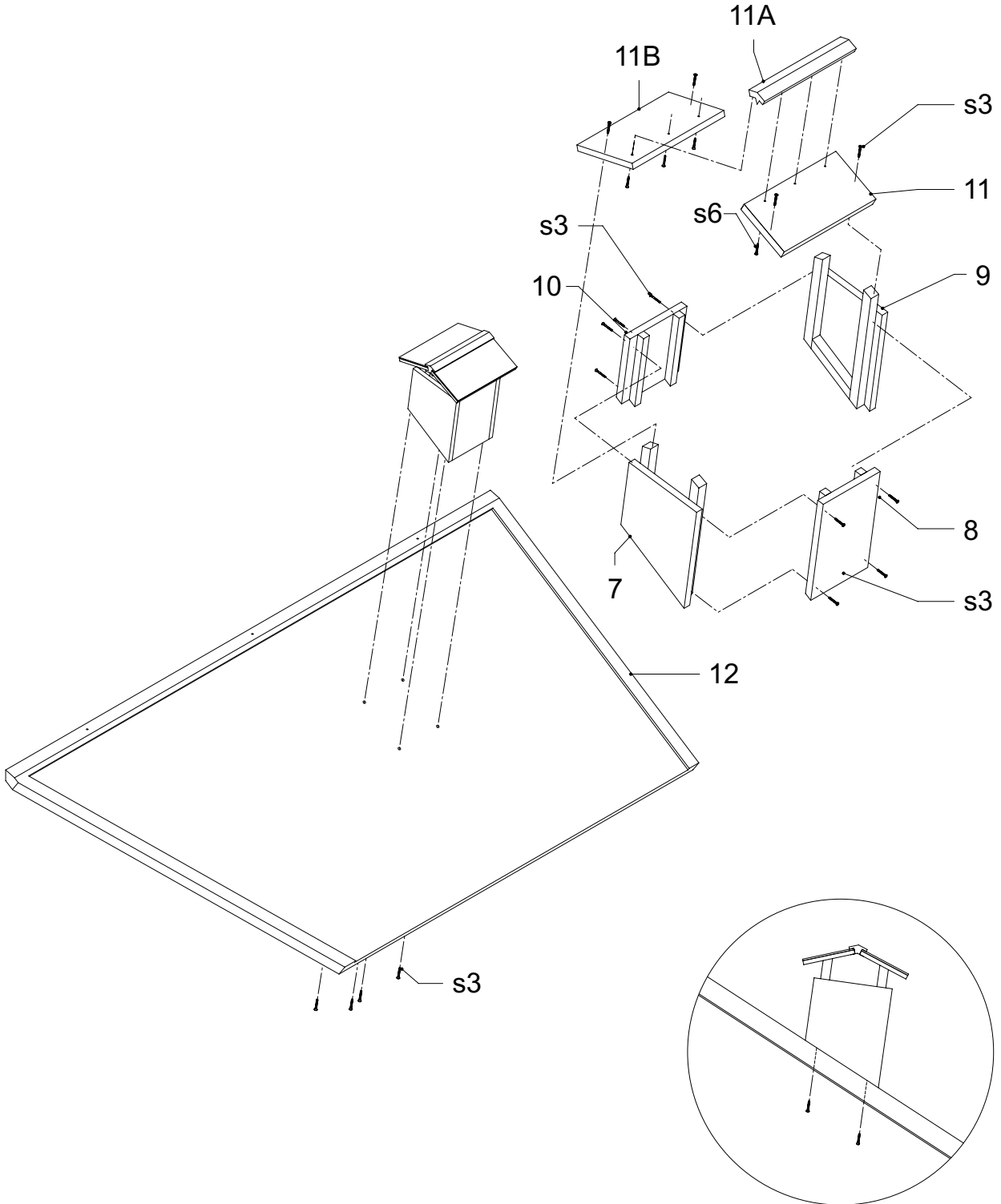

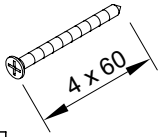

s2

4x

A030.113.XX

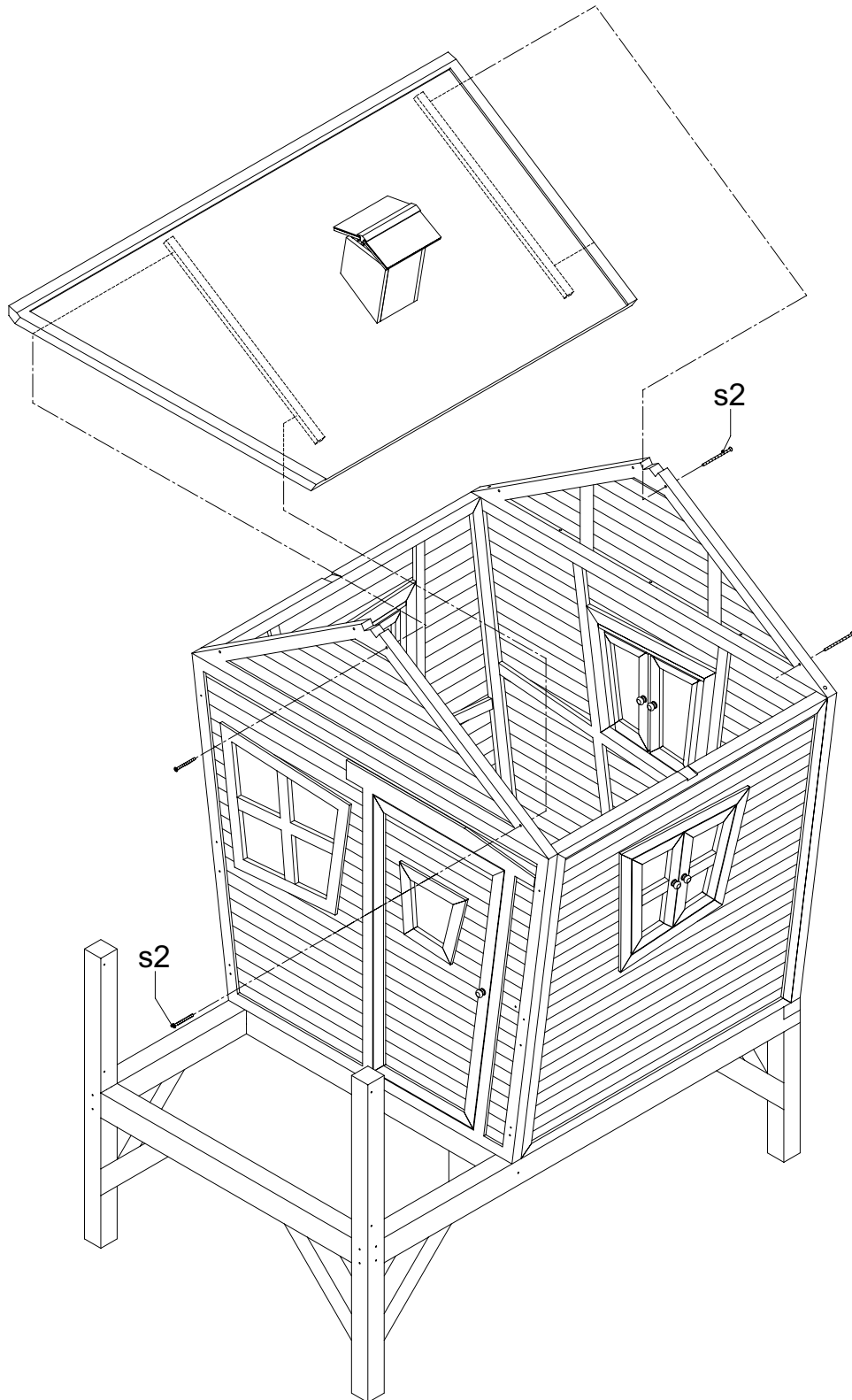

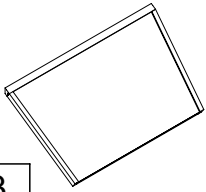

13

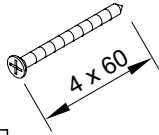

s2

4x

A030.113.XX

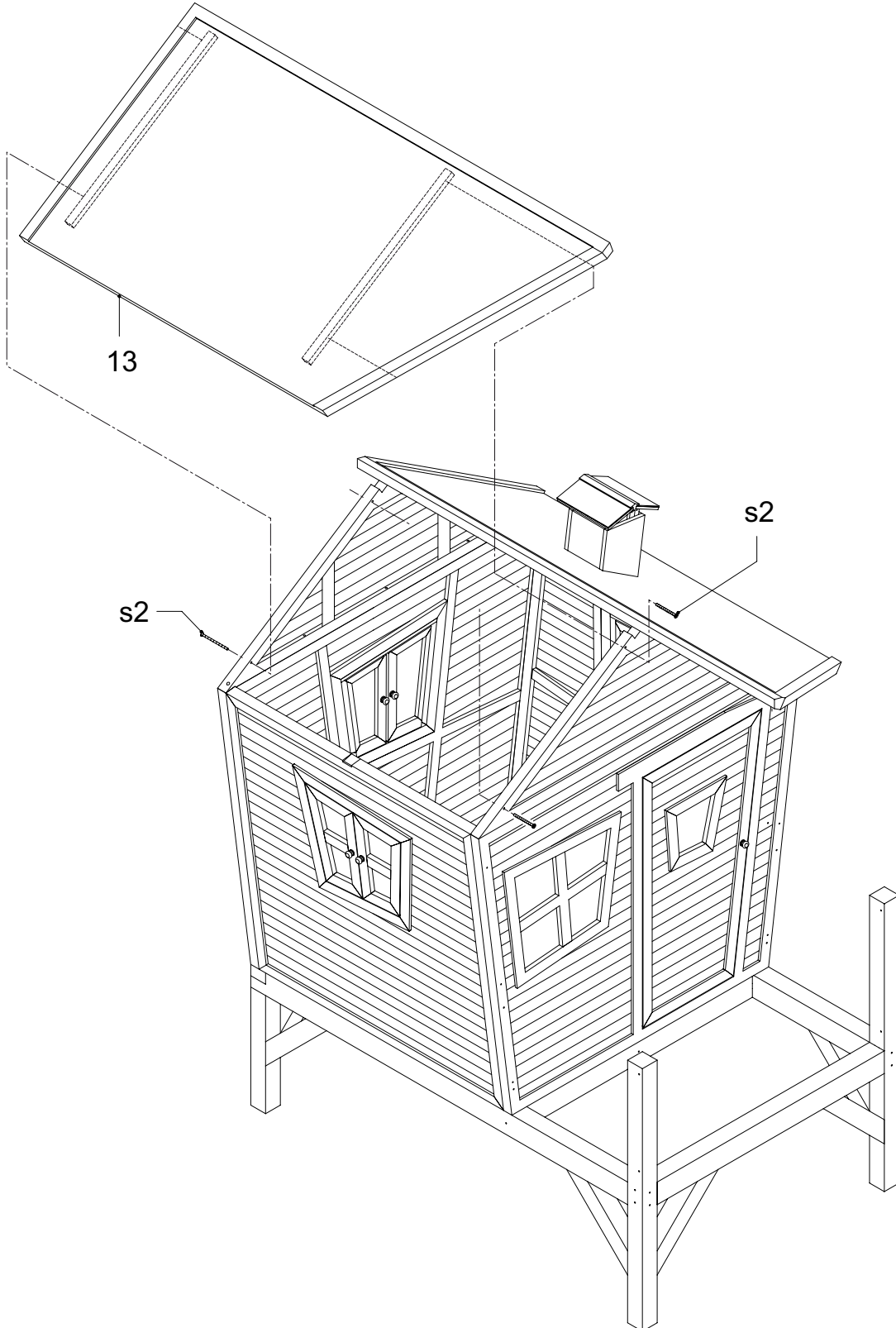



15

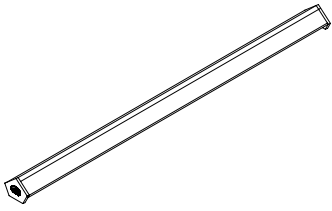

s4

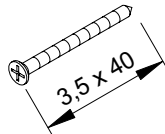

15x

A030.113.XX

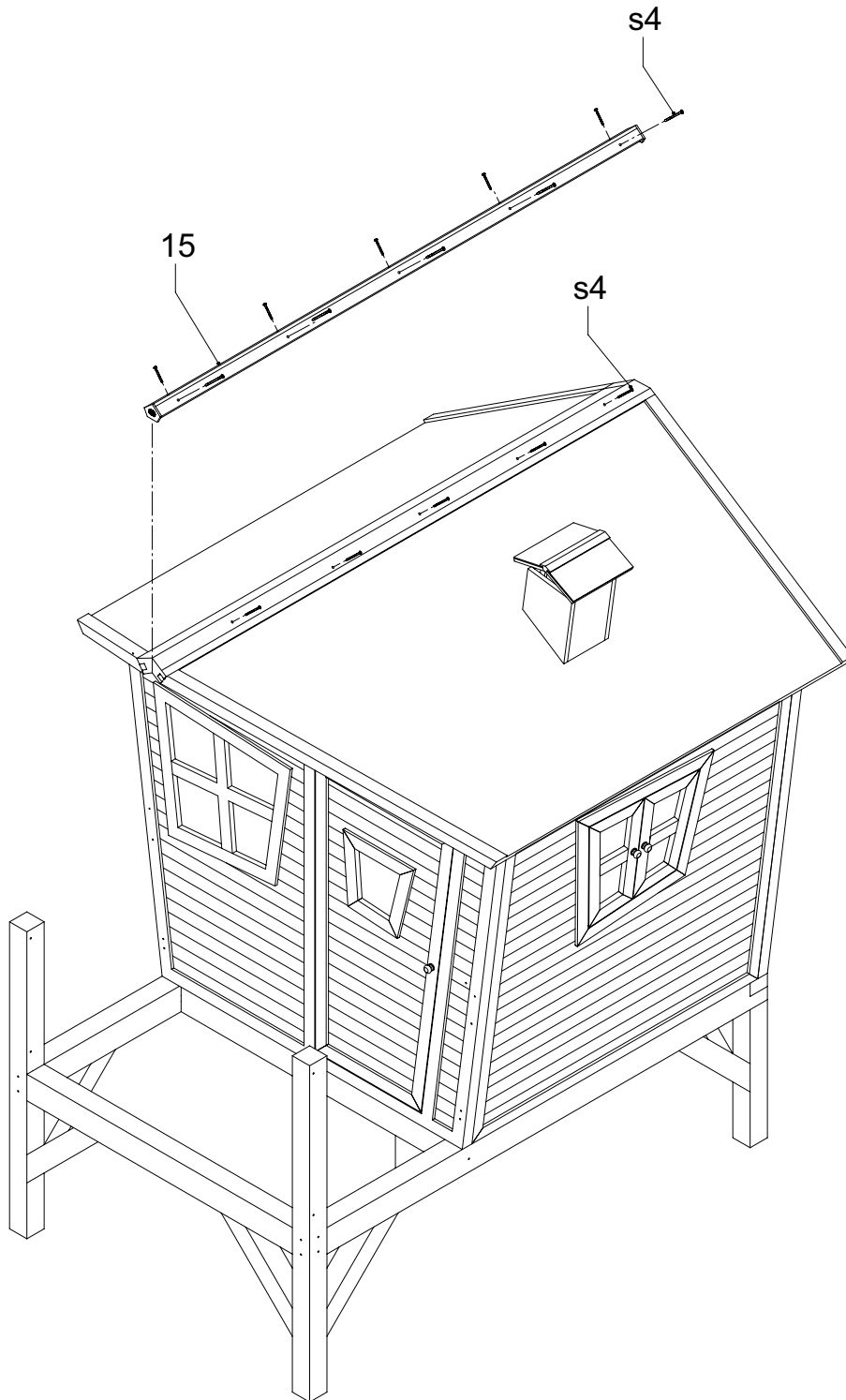



Iris

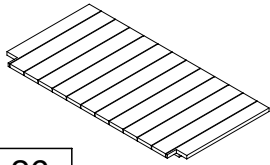

26

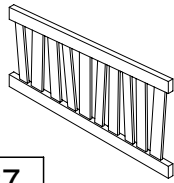

27

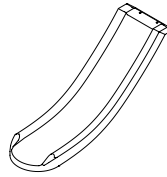

28

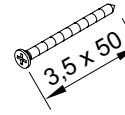

s1

6x

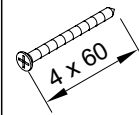

s2

2x

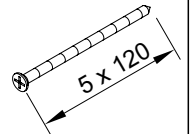

s7

4x

A039.060.XX + A030.116.XX

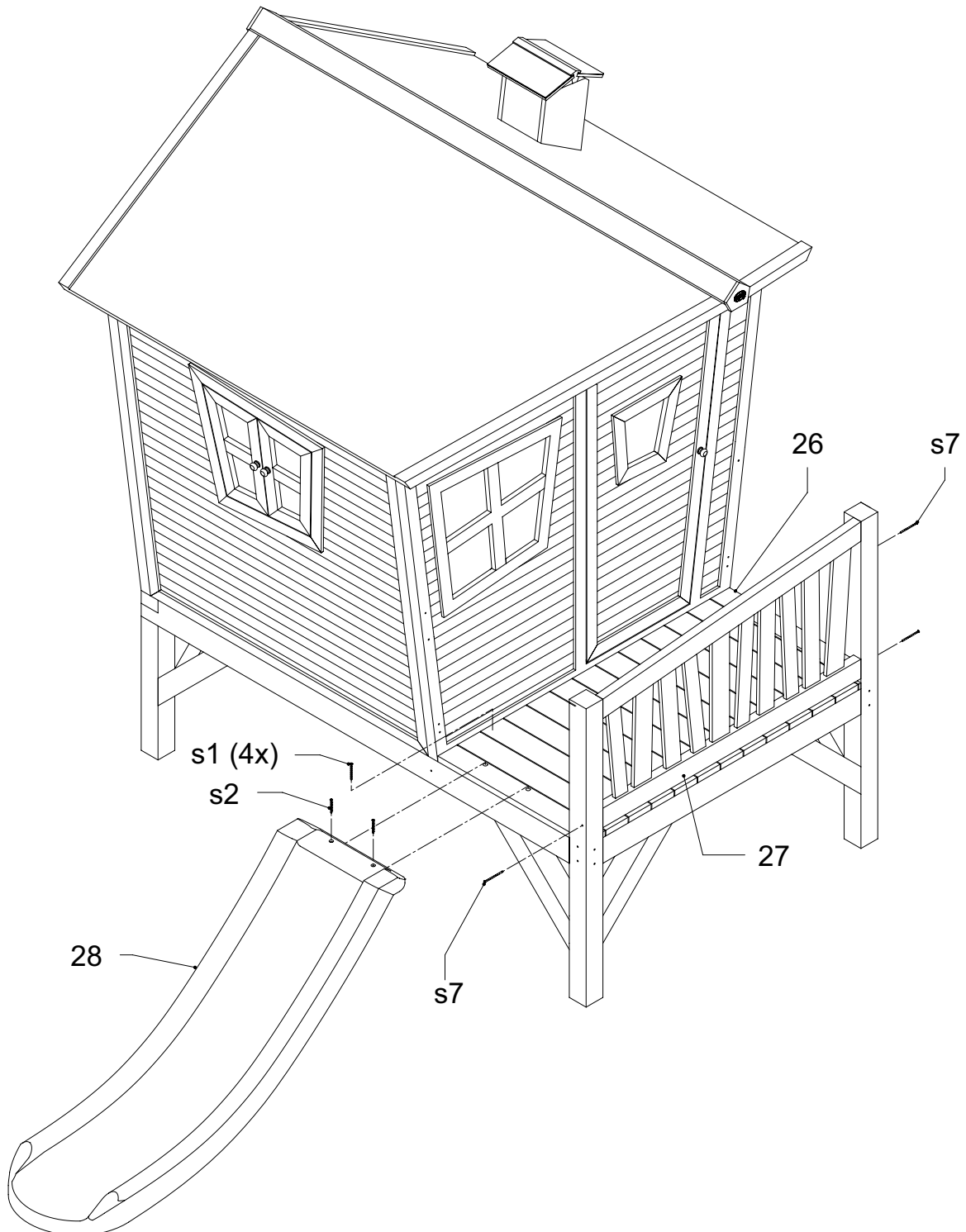



Iris

29	3x	30	31	32	s1	14x	s5	4x

A030.115.XX

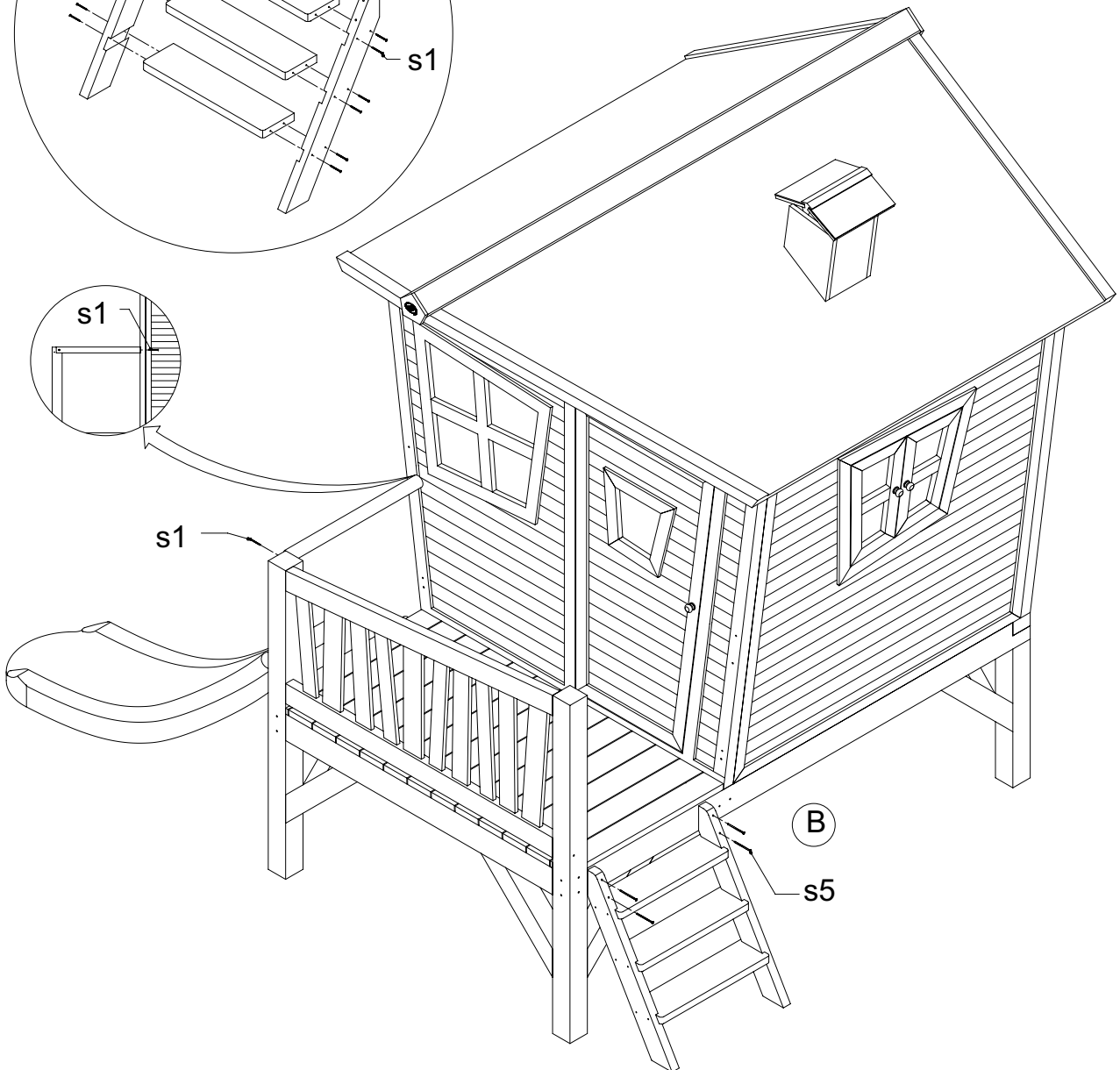
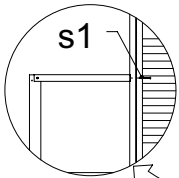
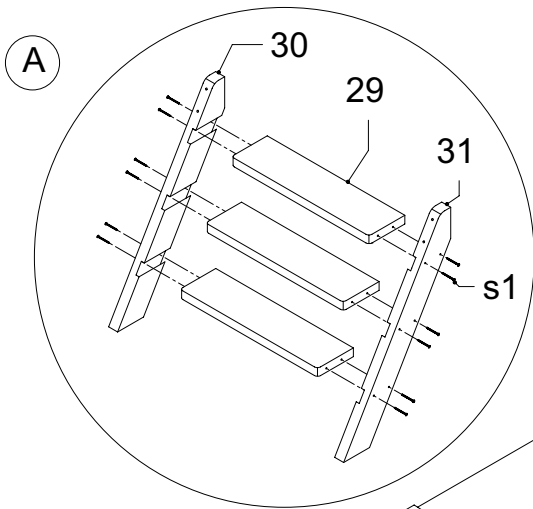

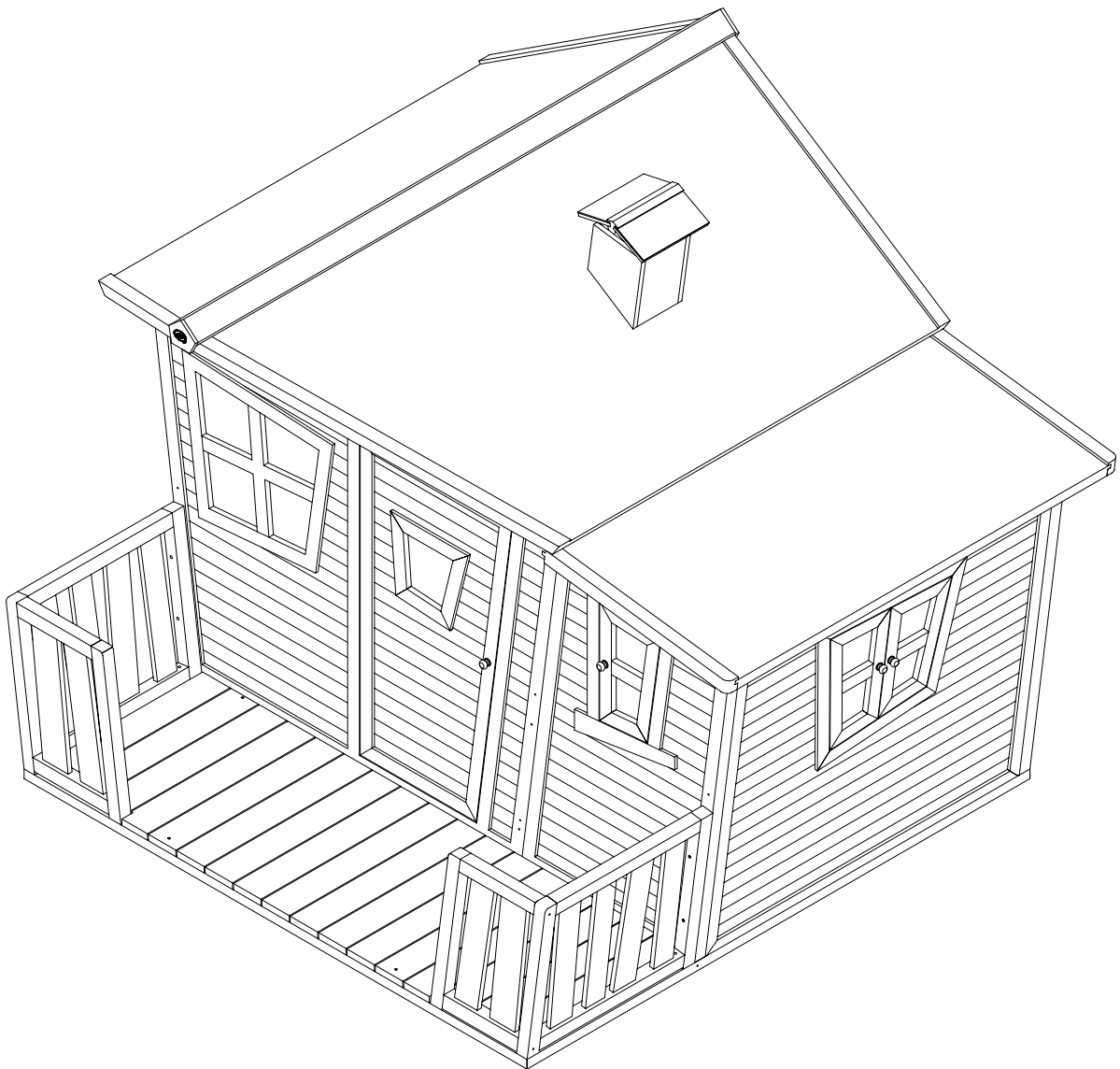



Lisa

A030.111.XX

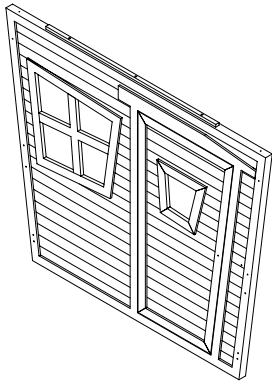

10

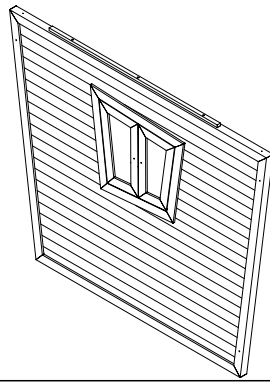

12

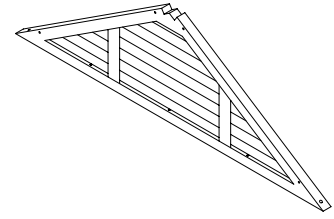

17

2x



13

14x

t1

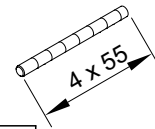

7x

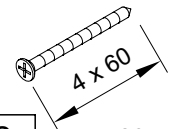

s2

26x

A030.113.XX

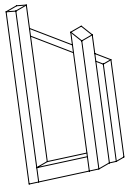

22

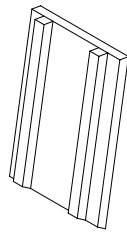

23

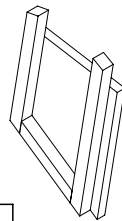

24

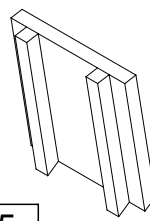

25

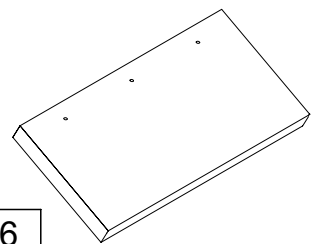

26

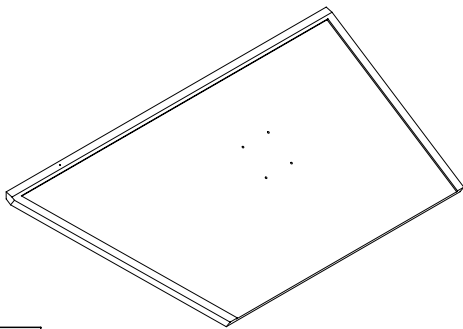

27

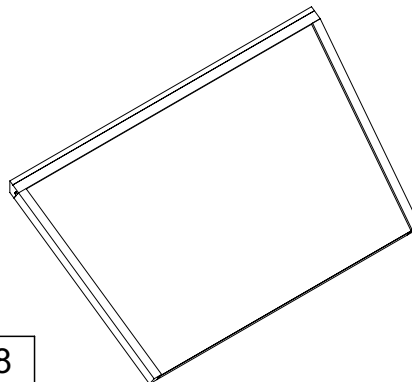

28

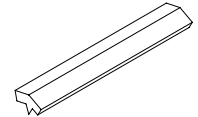

26A

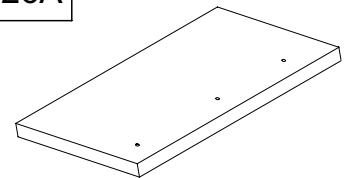

26B

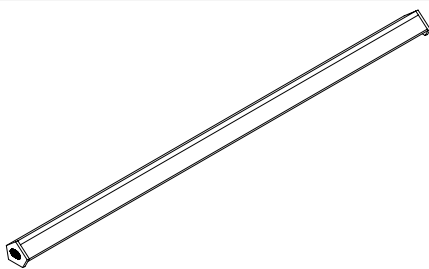

29

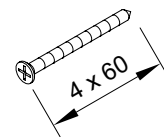

s2

8x

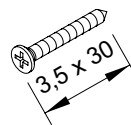

s3

16x

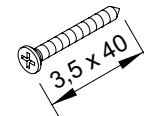

s4

15x

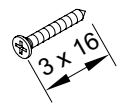

s6

6x

A030.117.00

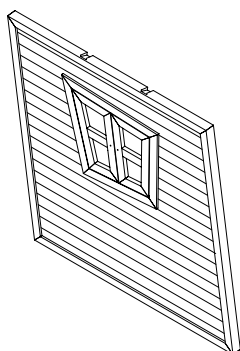

11

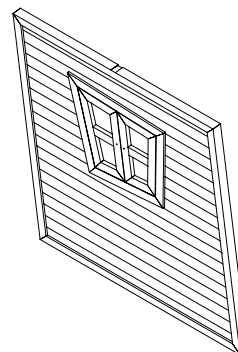

15



Lisa

A030.118.XX

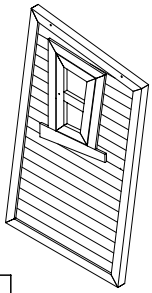

14

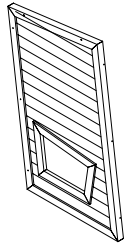

16

20

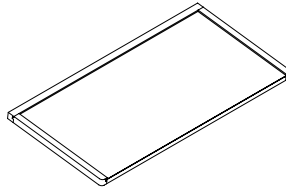

13



2x

21

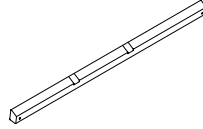

t1

1x

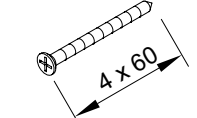
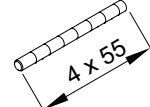

s2

14x

A030.119.XX

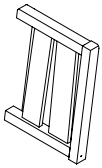

6

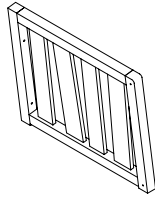

7

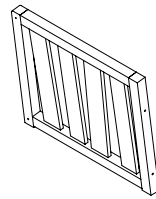

8

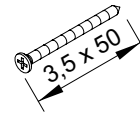

s1

12x

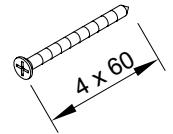

s2

12x

9

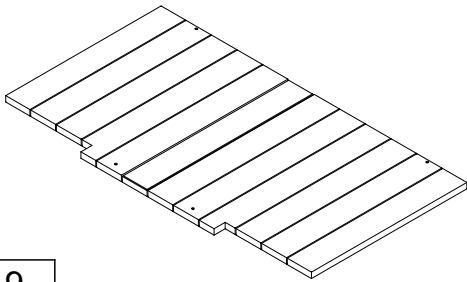

A030.120.XX

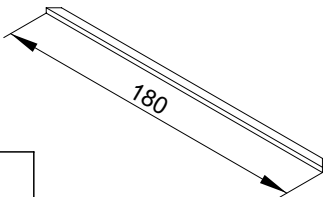

1

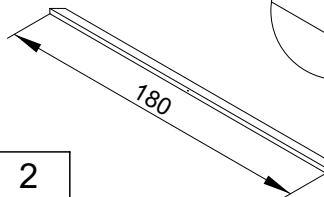

2

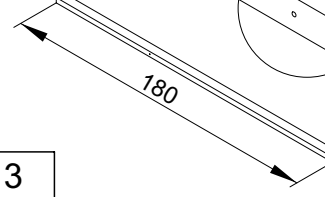

3

2x

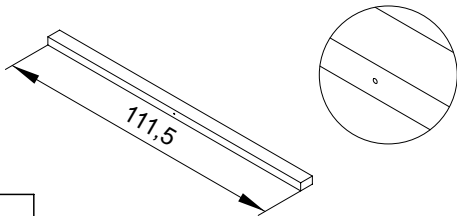

4

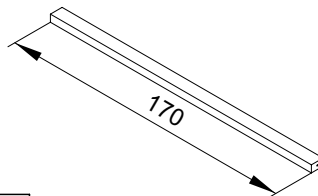

5

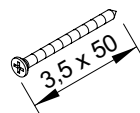

s1

8x

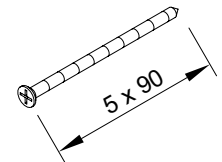

s5

4x

A030.142.XX

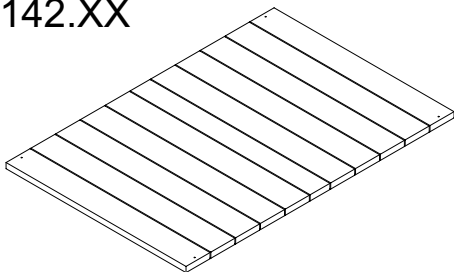

19

2x



Lisa

 1	 2	 3	 4	 5	 s1 8x	 s5 4x
-------	-------	-------	-------	-------	-----------	-----------

A030.120.XX

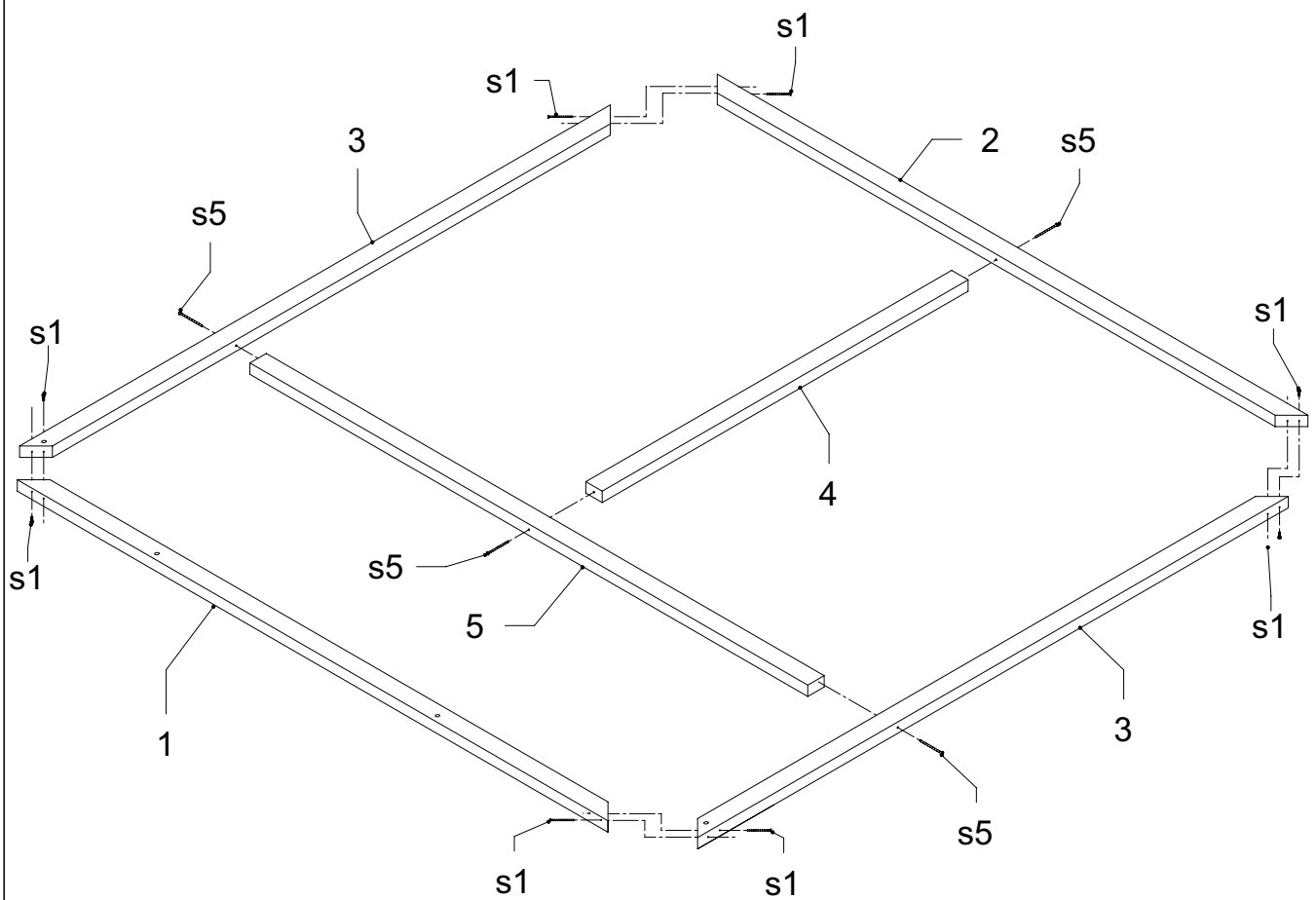



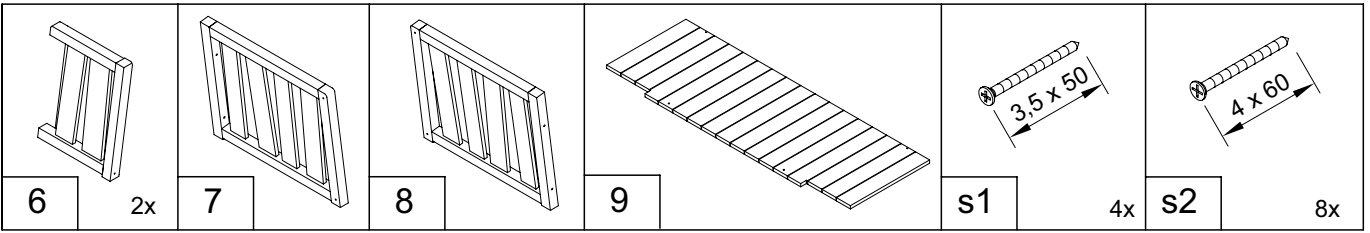

Lisa

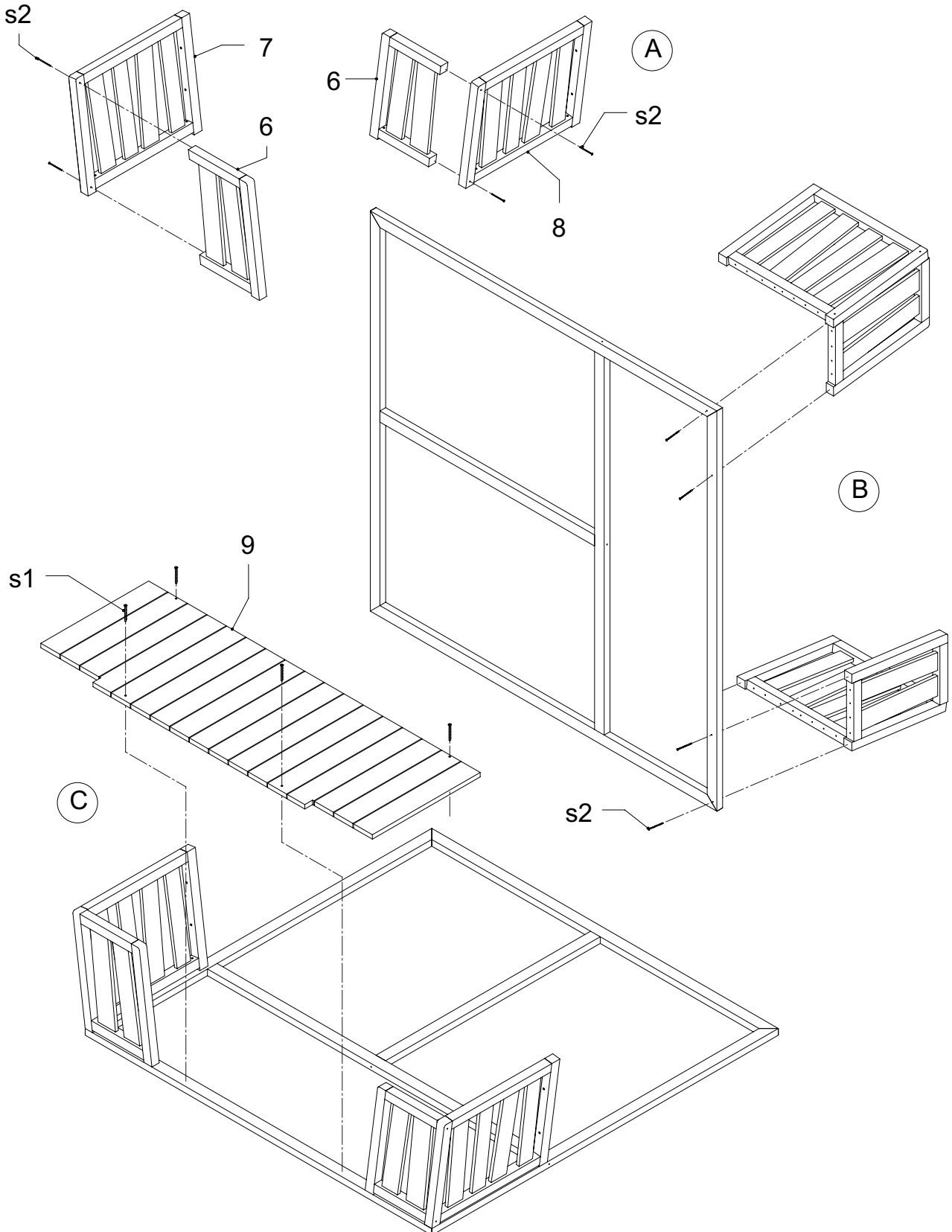

A030.119.XX



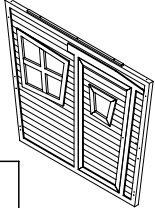
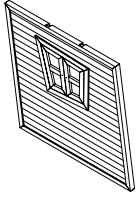
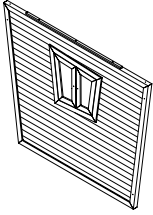

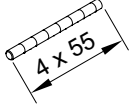
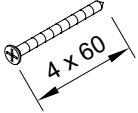
								
10	11	12	13	10x	t1	5x	s2	8x

A030.111.XX + A030.117.XX

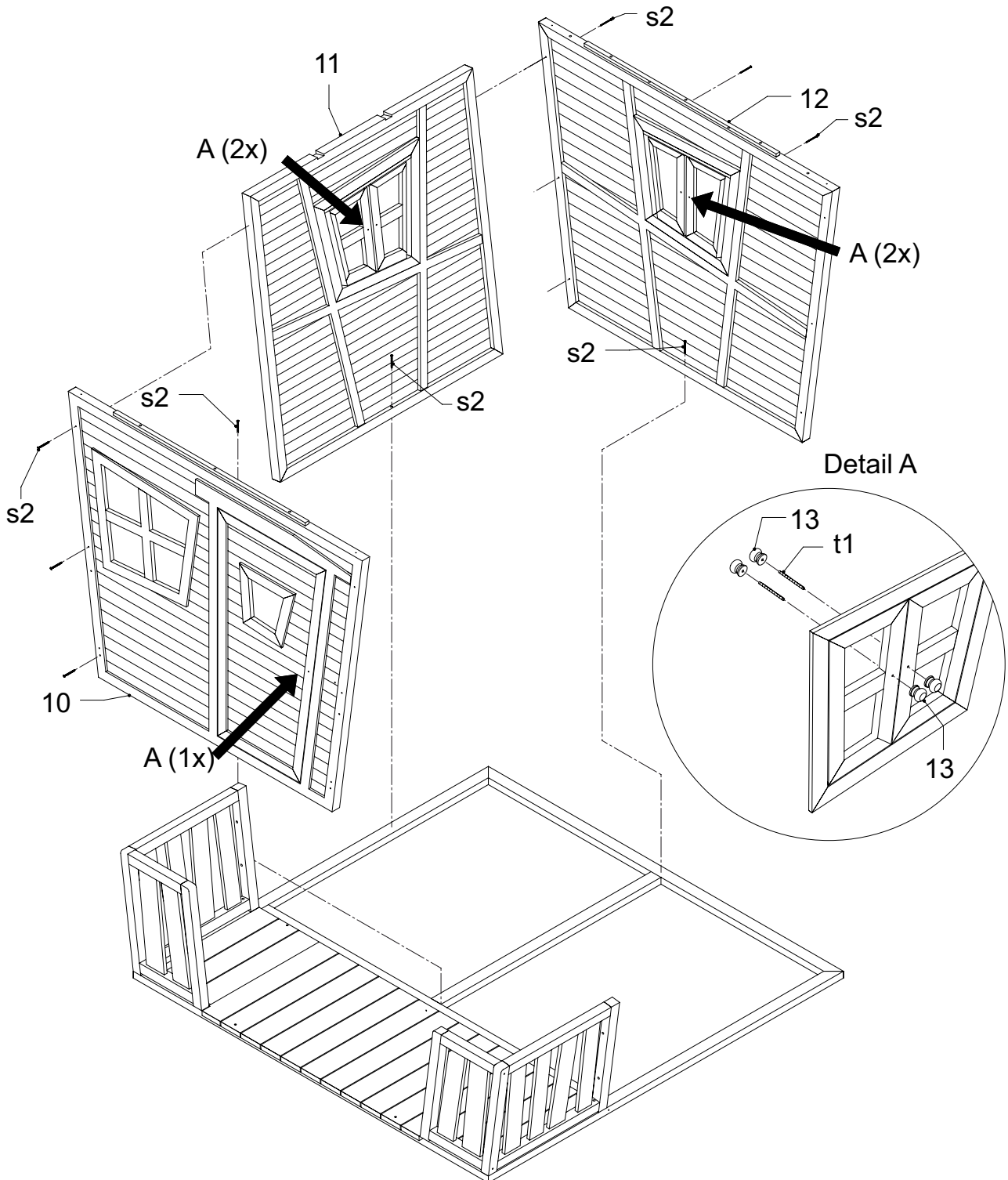

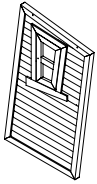

14

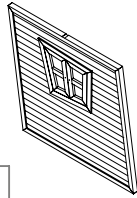

15

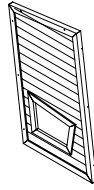

16



13

6x

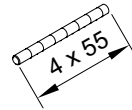

t1

3x

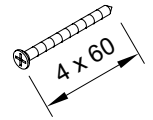

s2

6x

A030.117.XX + A030.118.XX

Detail A

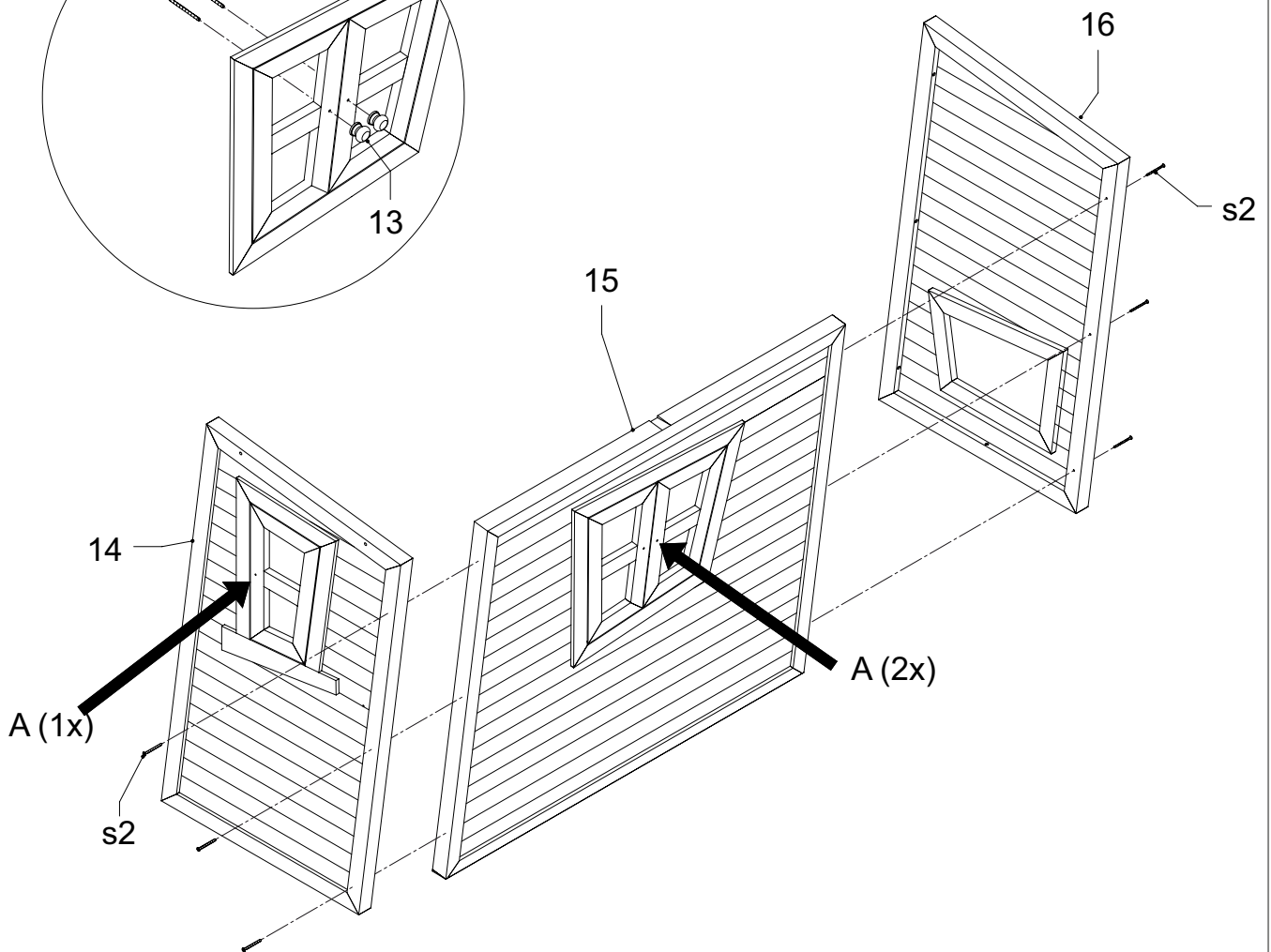
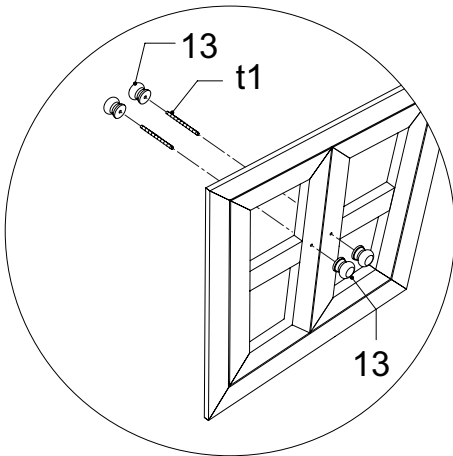

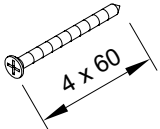

s2

9x

A030.111.XX

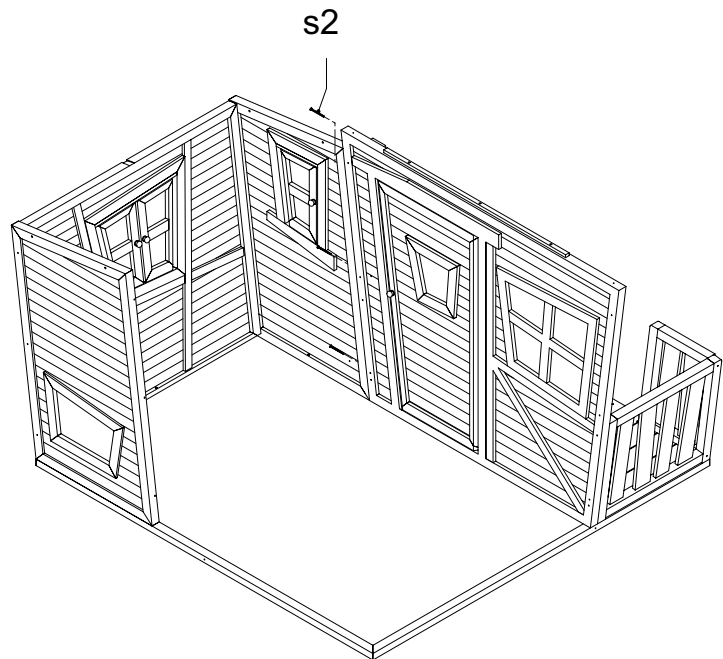
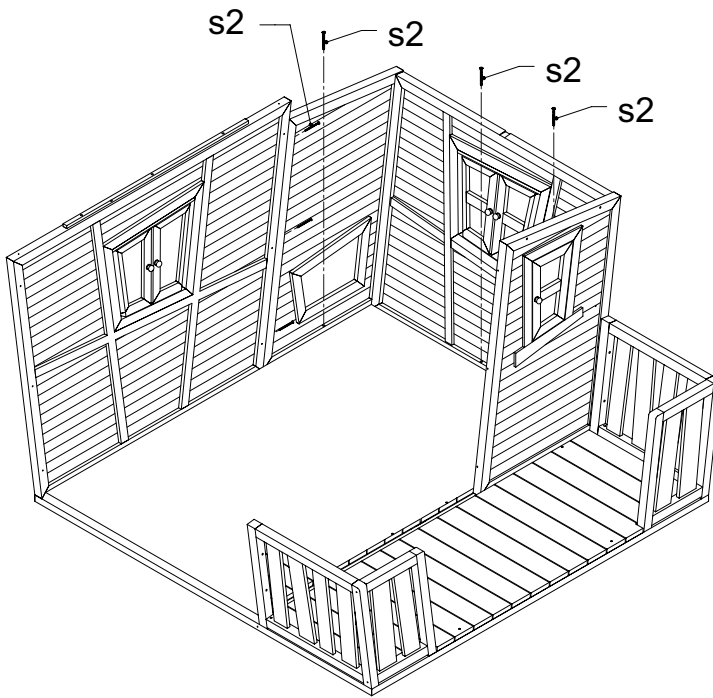

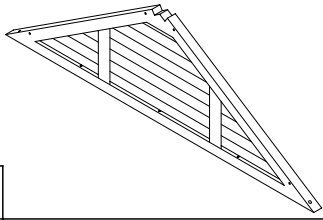

17

2x

s2

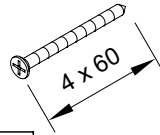

14x

A030.111.XX + A030.119.XX

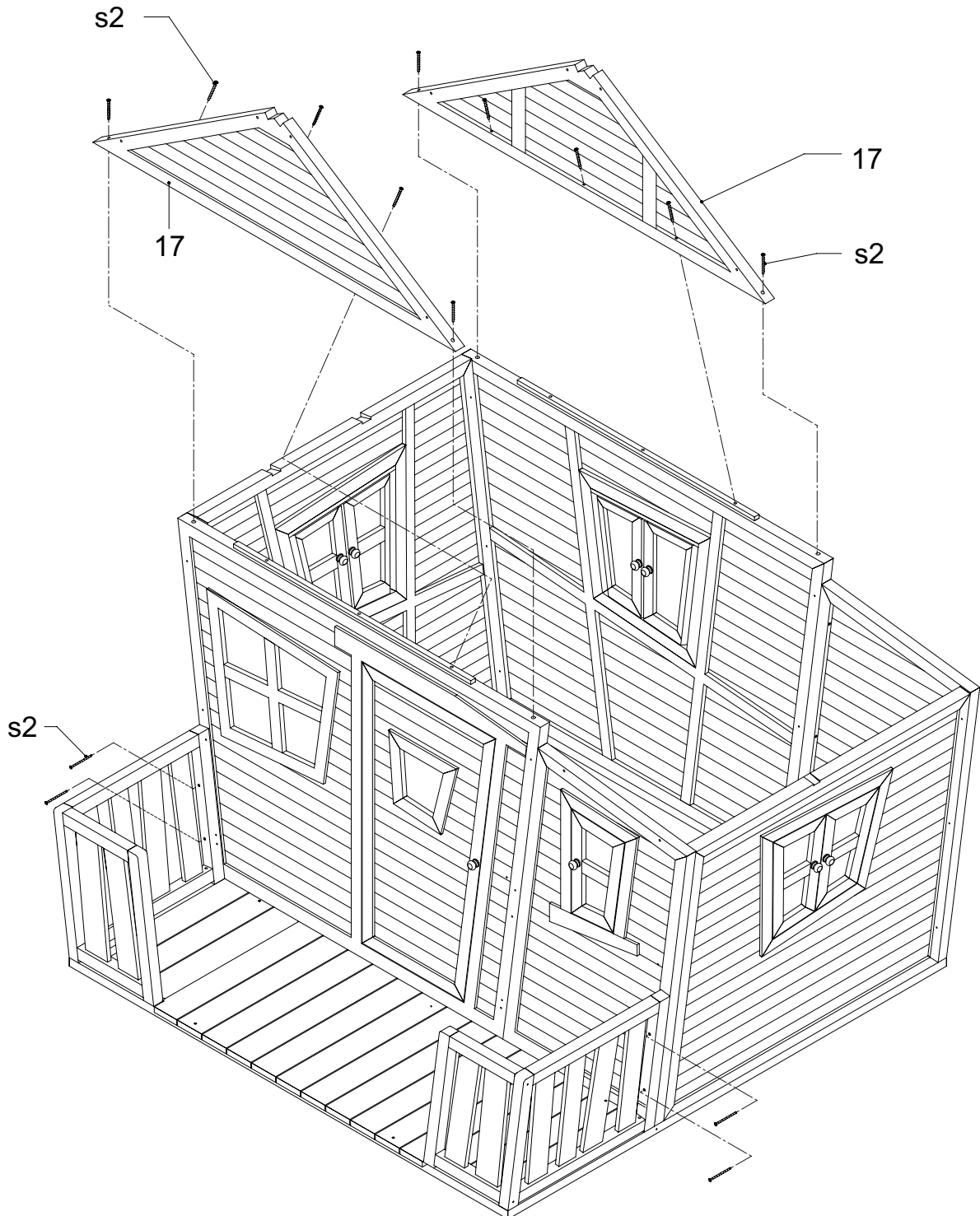

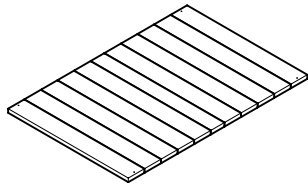

19

2x

s1

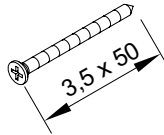

8x

A030.119.XX + A030.142.XX

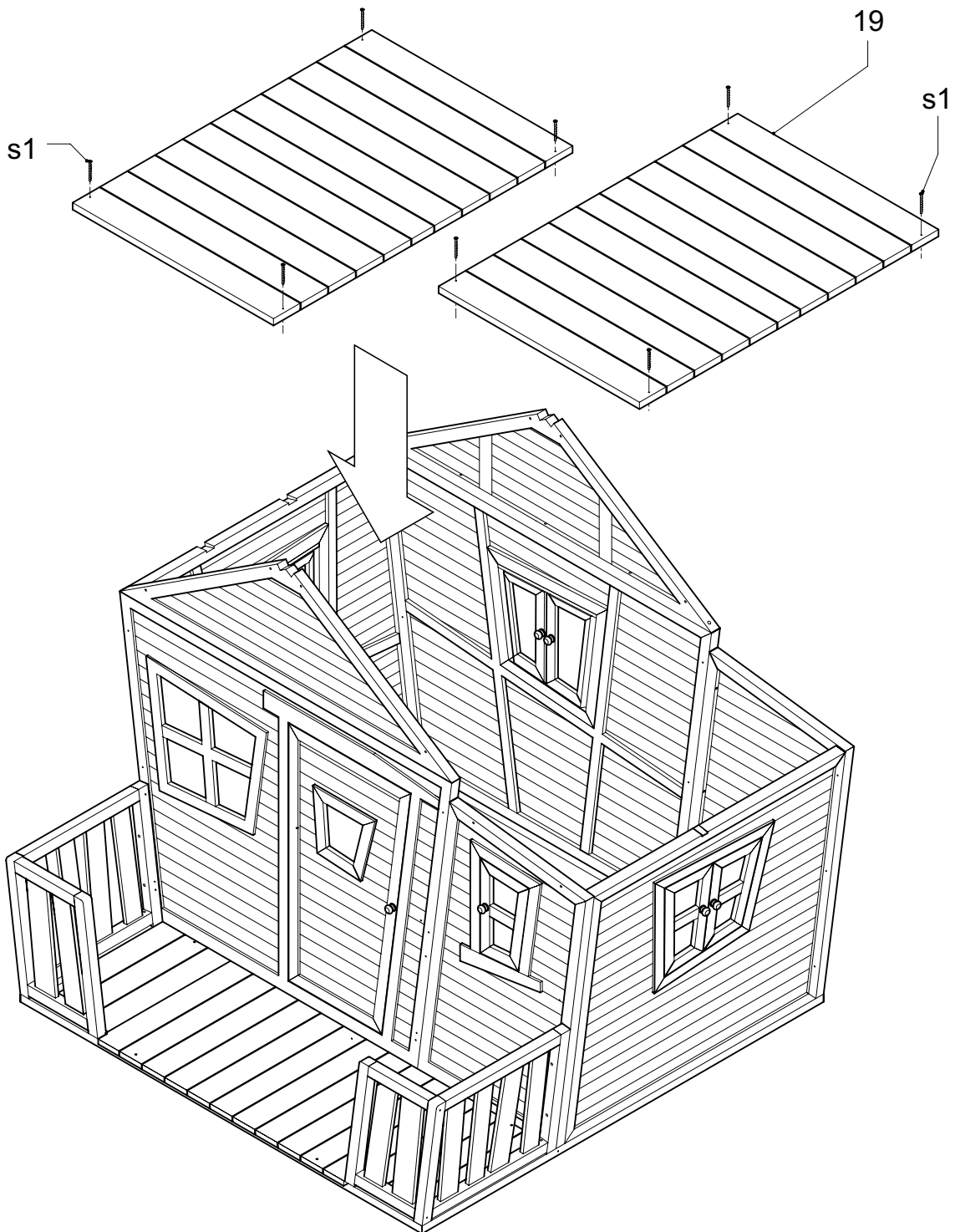

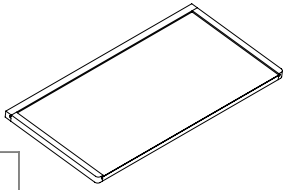

20

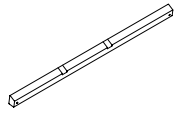

21

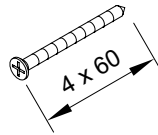

s2

6x

A030.118.XX

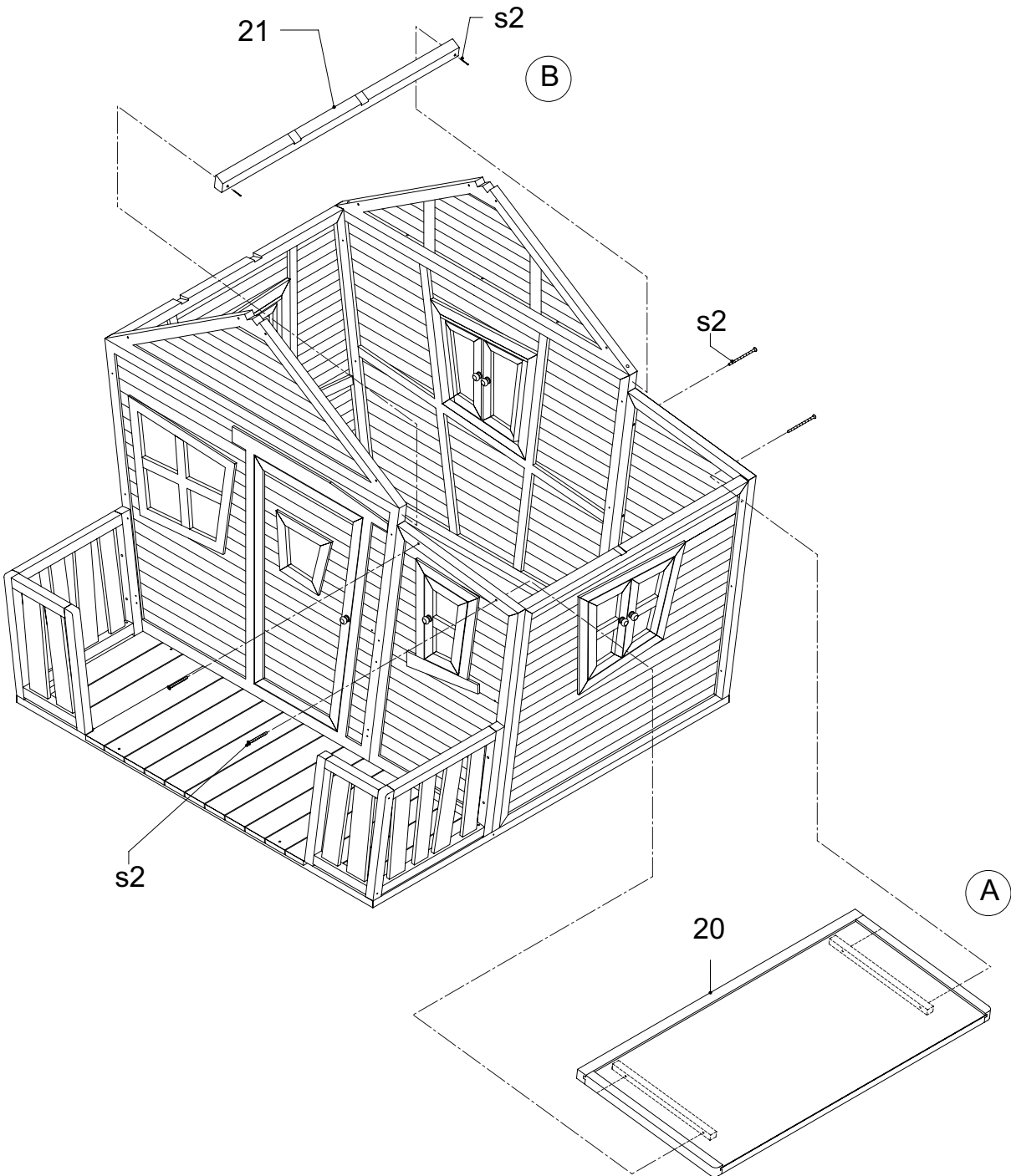



Lisa

22	23	24	25	26	26A	26B	27	s3 16x	s6 6x

A030.113.XX

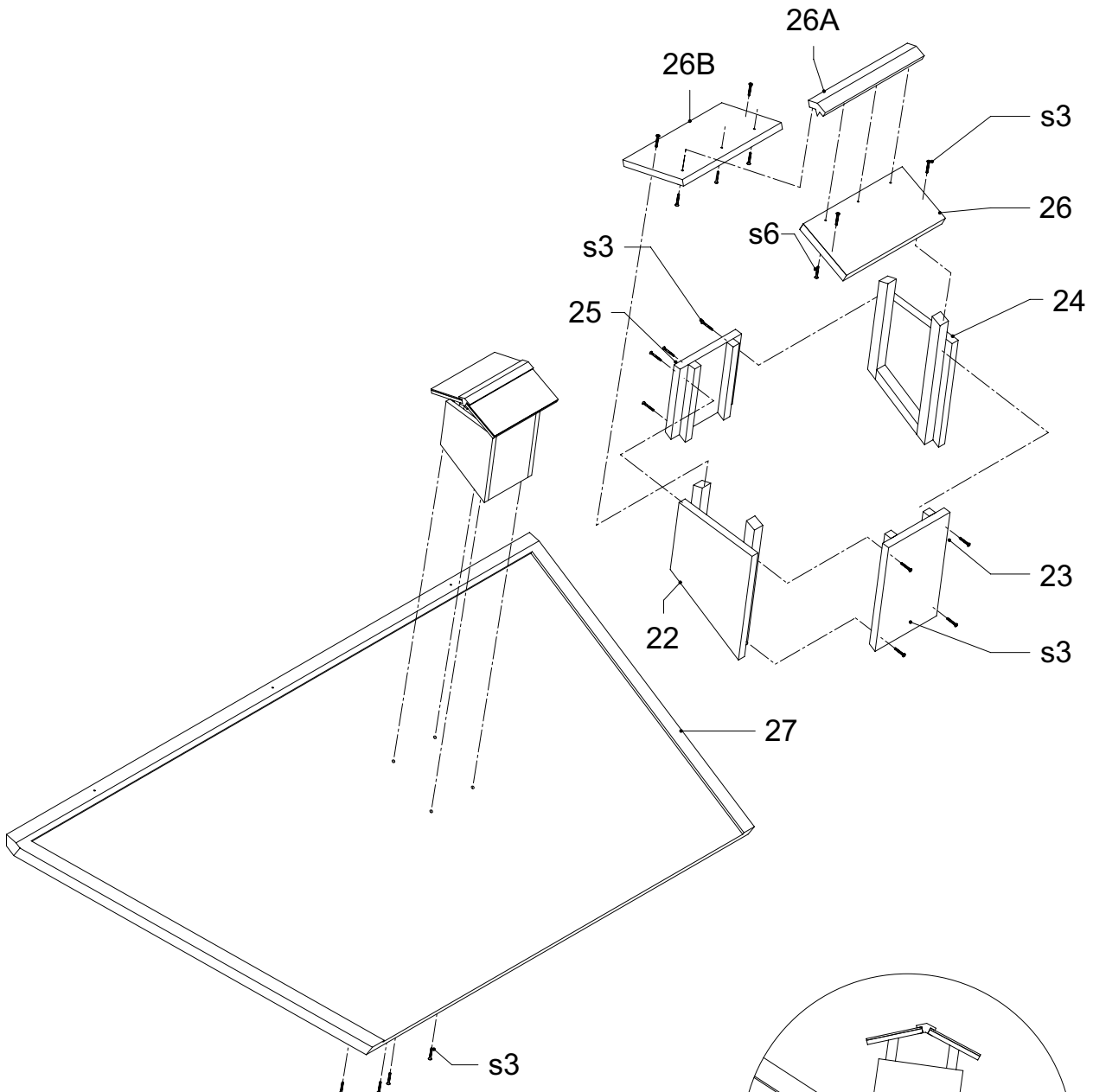

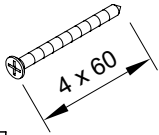

s2

4x

A030.113.XX

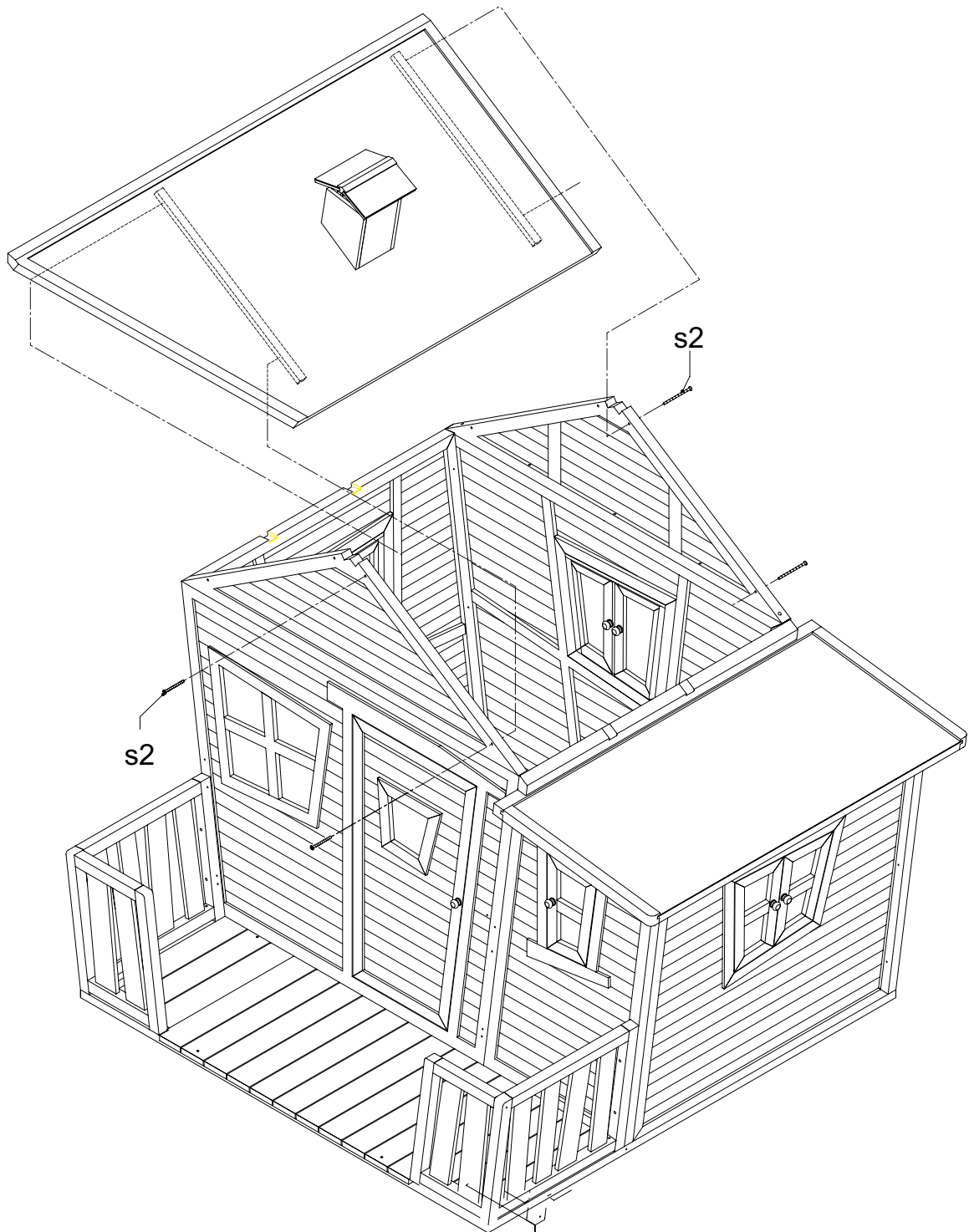

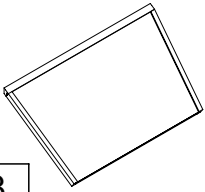

28

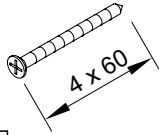

s2

4x

A030.113.XX

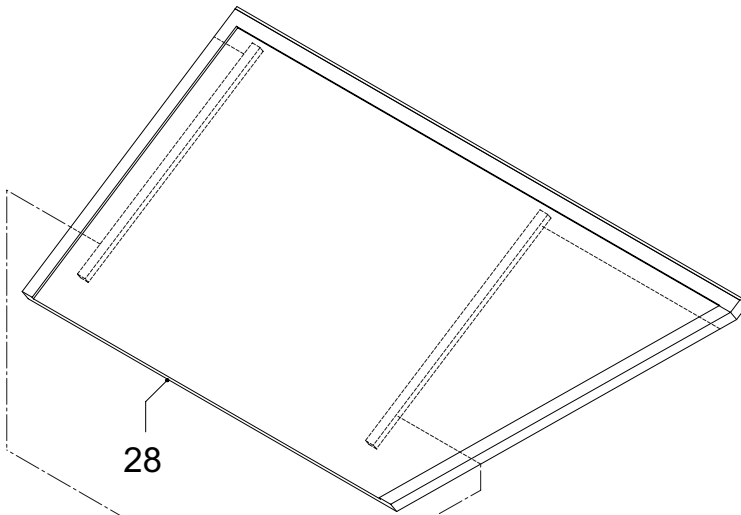

28

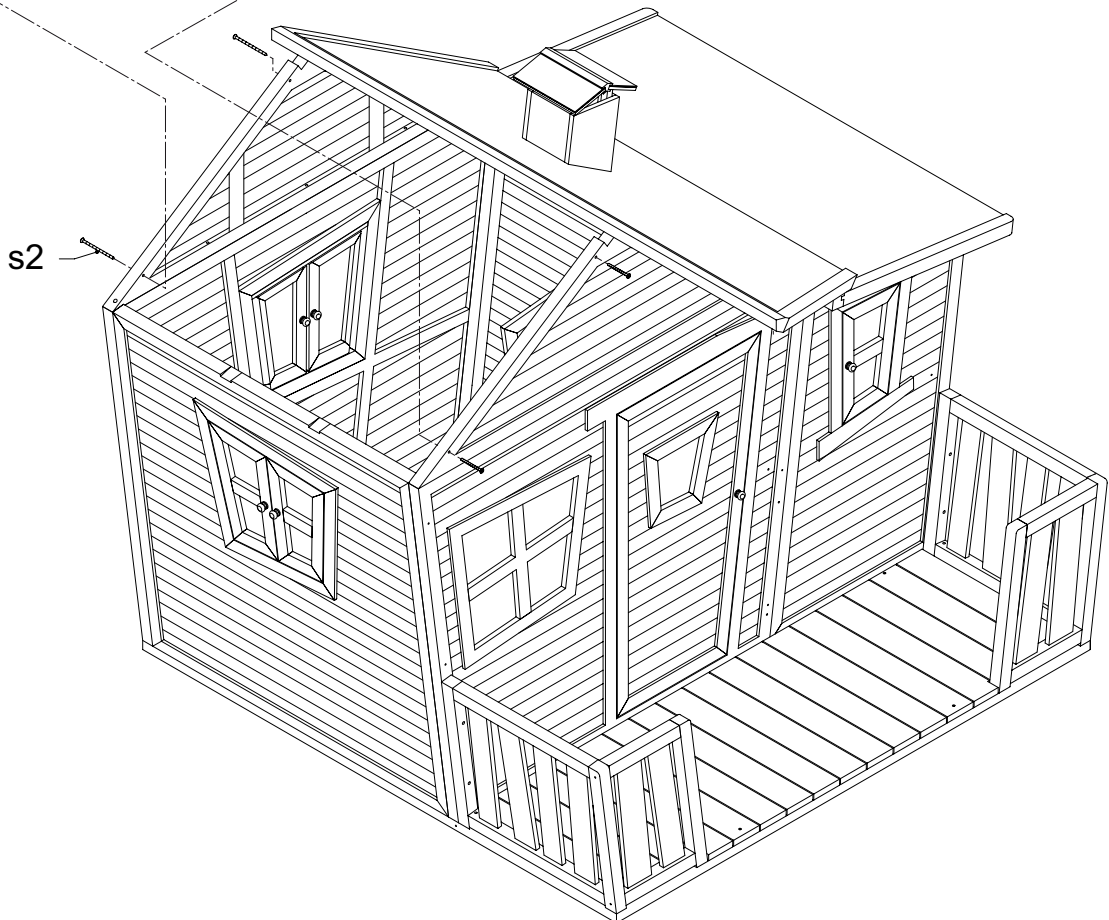

s2



29

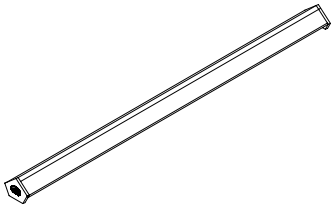

s4

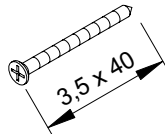

15x

A030.113.XX

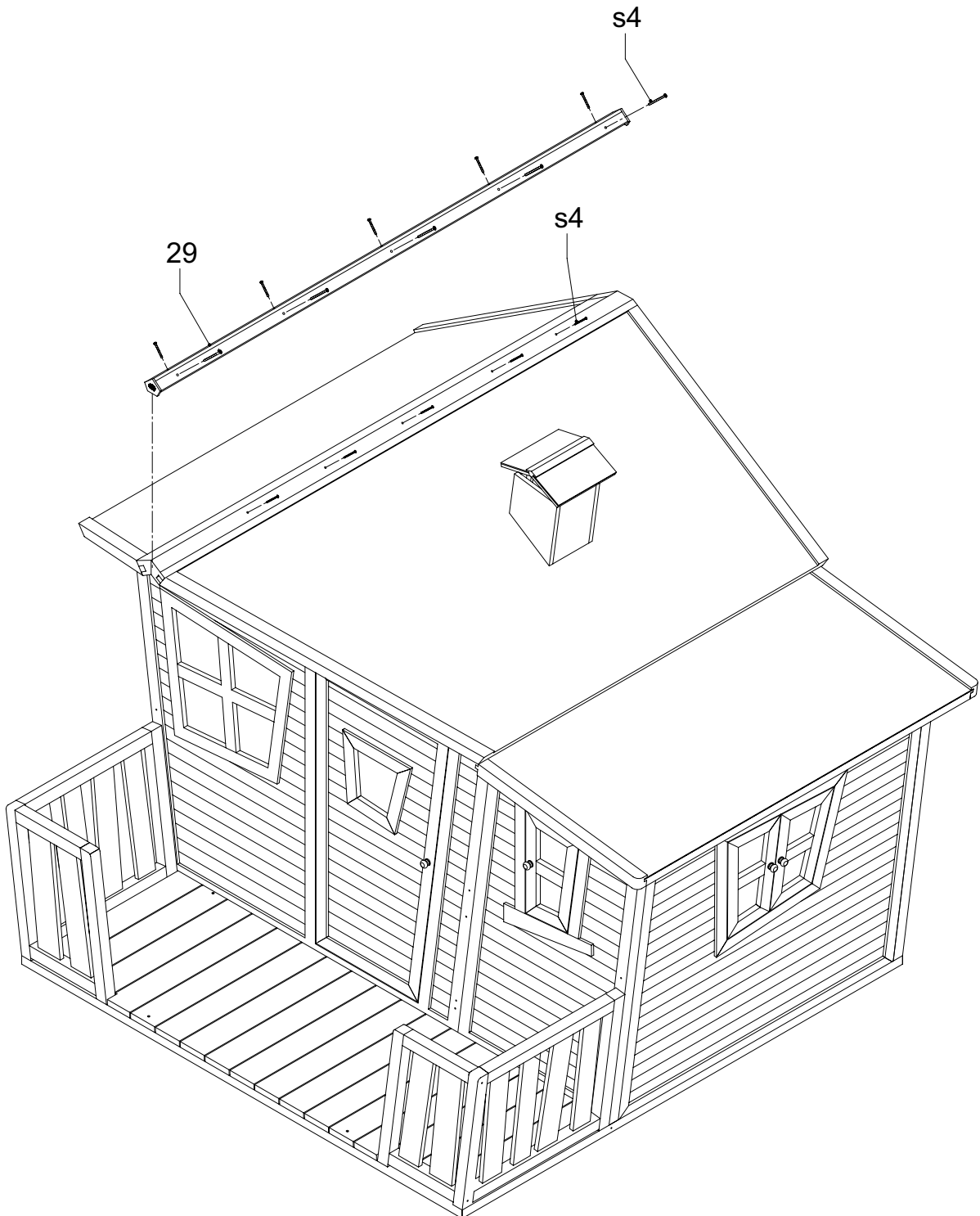

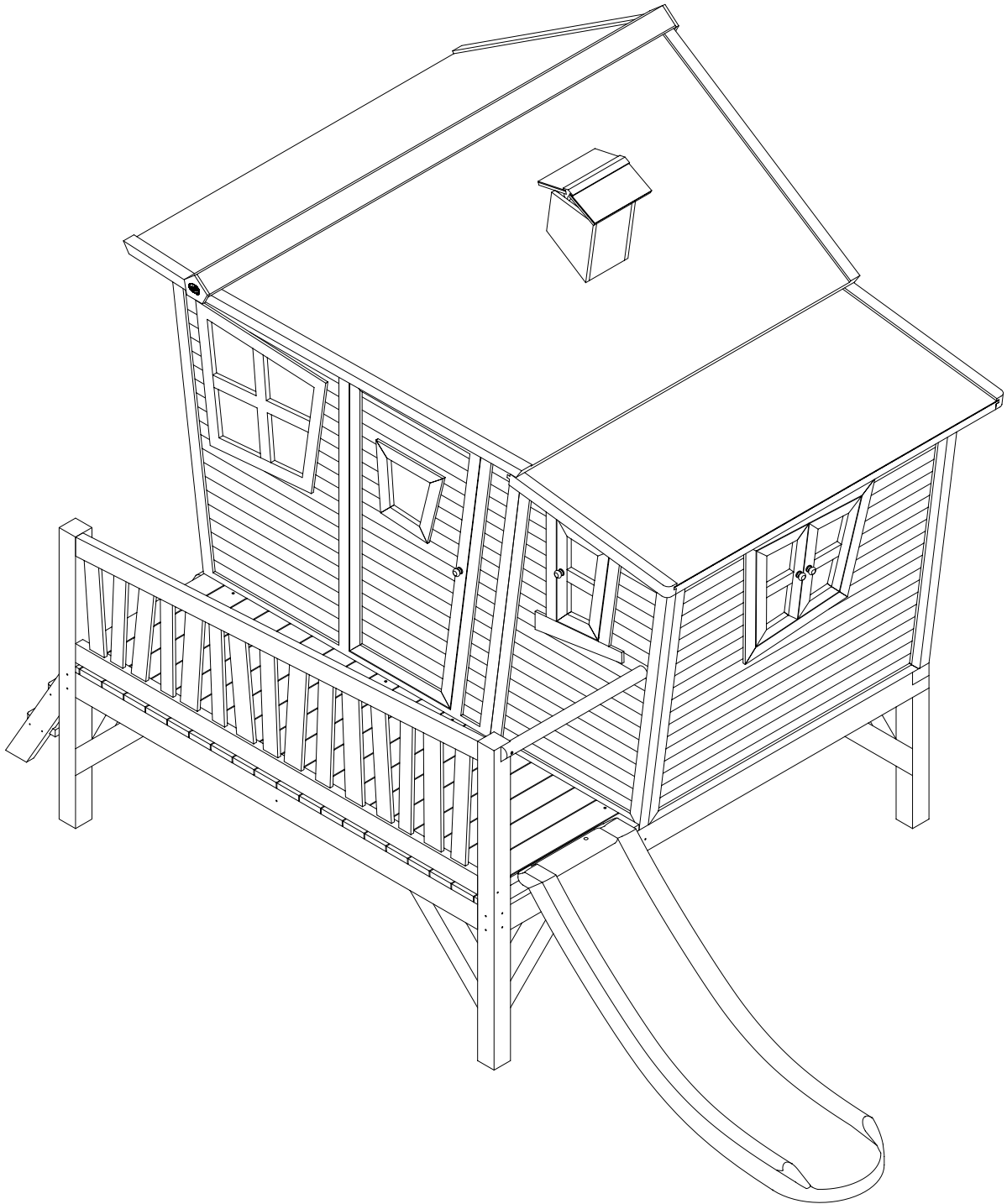



Emma

A030.111.XX

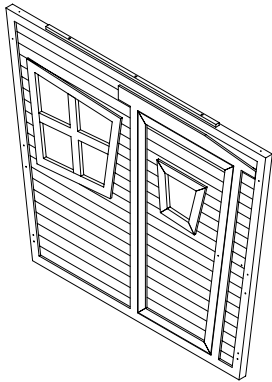

1

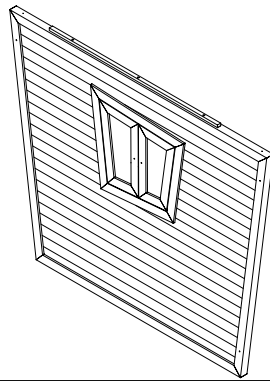

3



4

14x

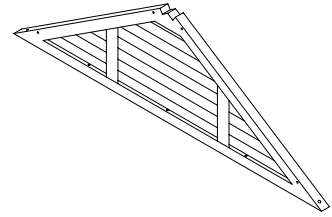

8

2x

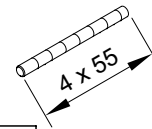

t1

7x

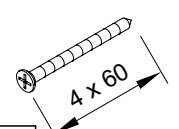

s2

26x

A030.113.XX

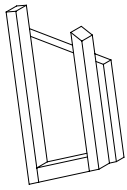

13

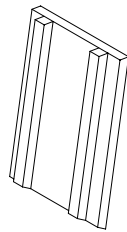

14

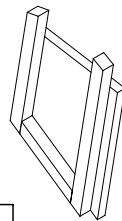

15

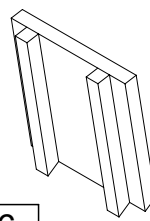

16

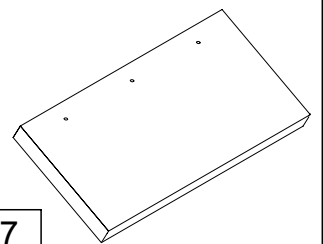

17

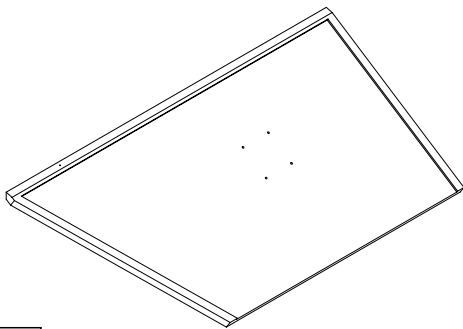

18

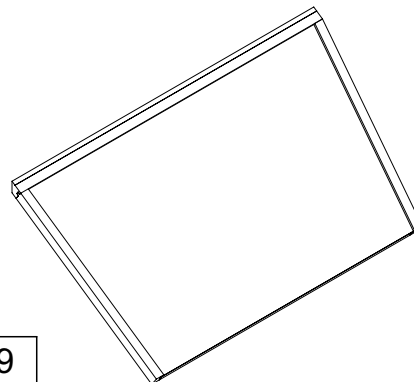

19

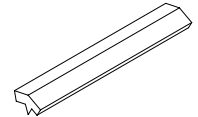

17A

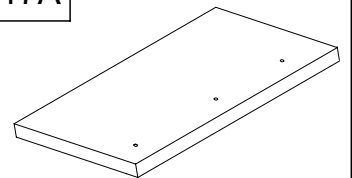

17B

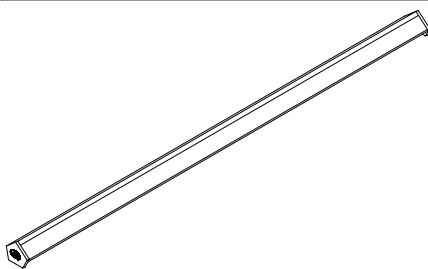

20

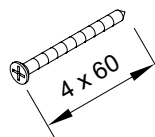

s2

8x

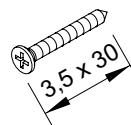

s3

16x

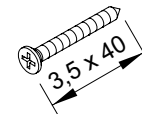

s4

15x

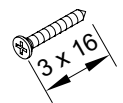

s6

6x

A030.117.XX

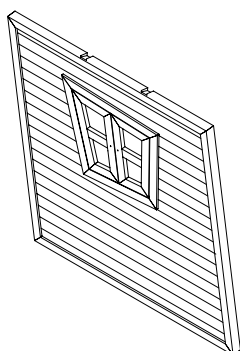

2

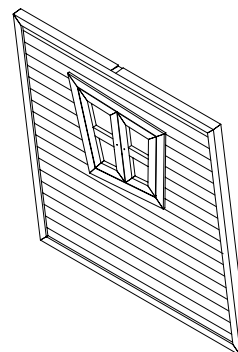

6



Emma

A030.118.XX

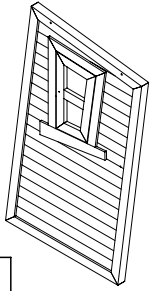

5

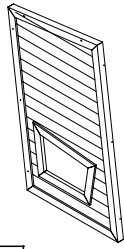

7

11

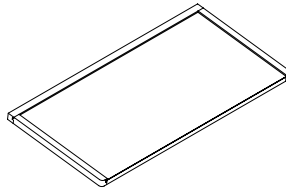

12

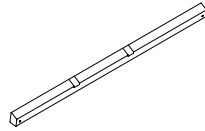

4



2x

t1

1x

s2

14x

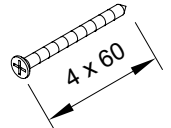
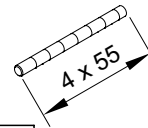

A030.121.XX

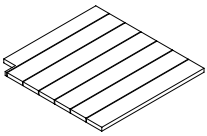

32

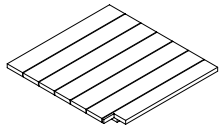

32A

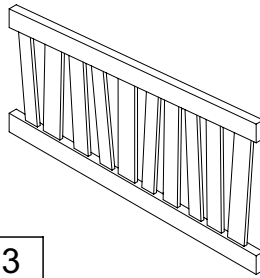

33

s1

16x

s2

2x

s7

4x

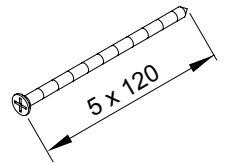
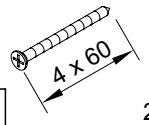
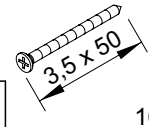

A030.122.00

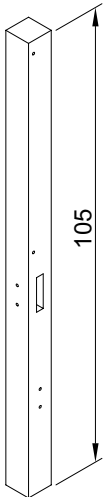

21

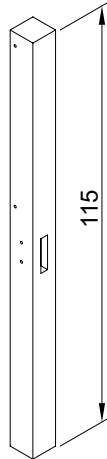

22

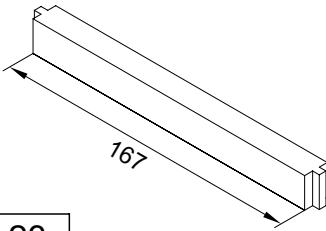

23

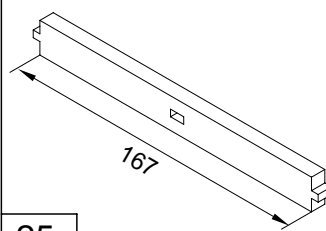

25

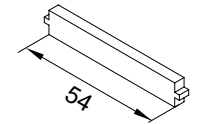

26

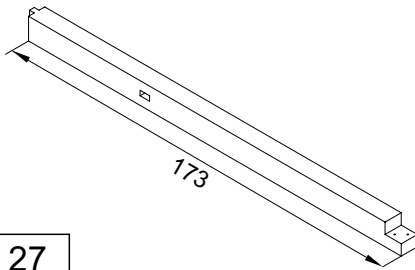

27

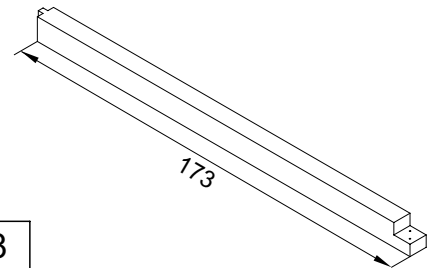

28

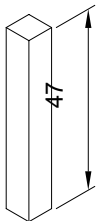

29

2x

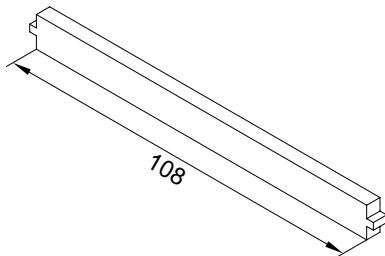

30

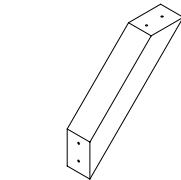

24

8x

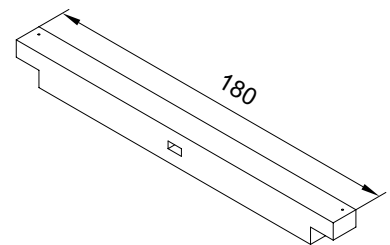

31

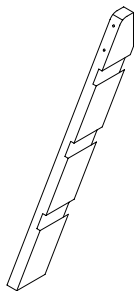

37

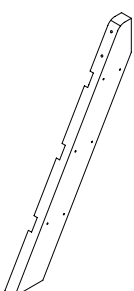

38

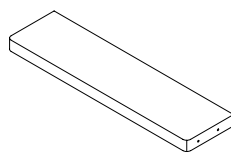

36

3x

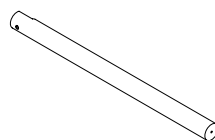

35

s1

14x

s2

16x

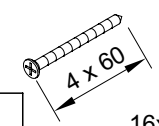
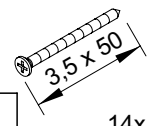

s5

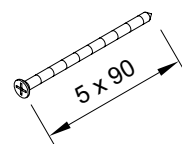

40x



A030.142.XX

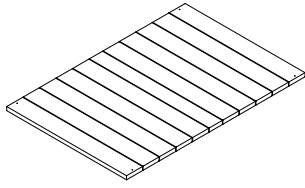

9

2x

A039.060.XX

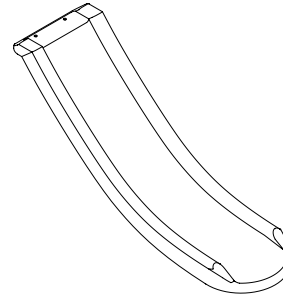

34



21	22	23	24	2x s5	8x s2

A030.122.XX

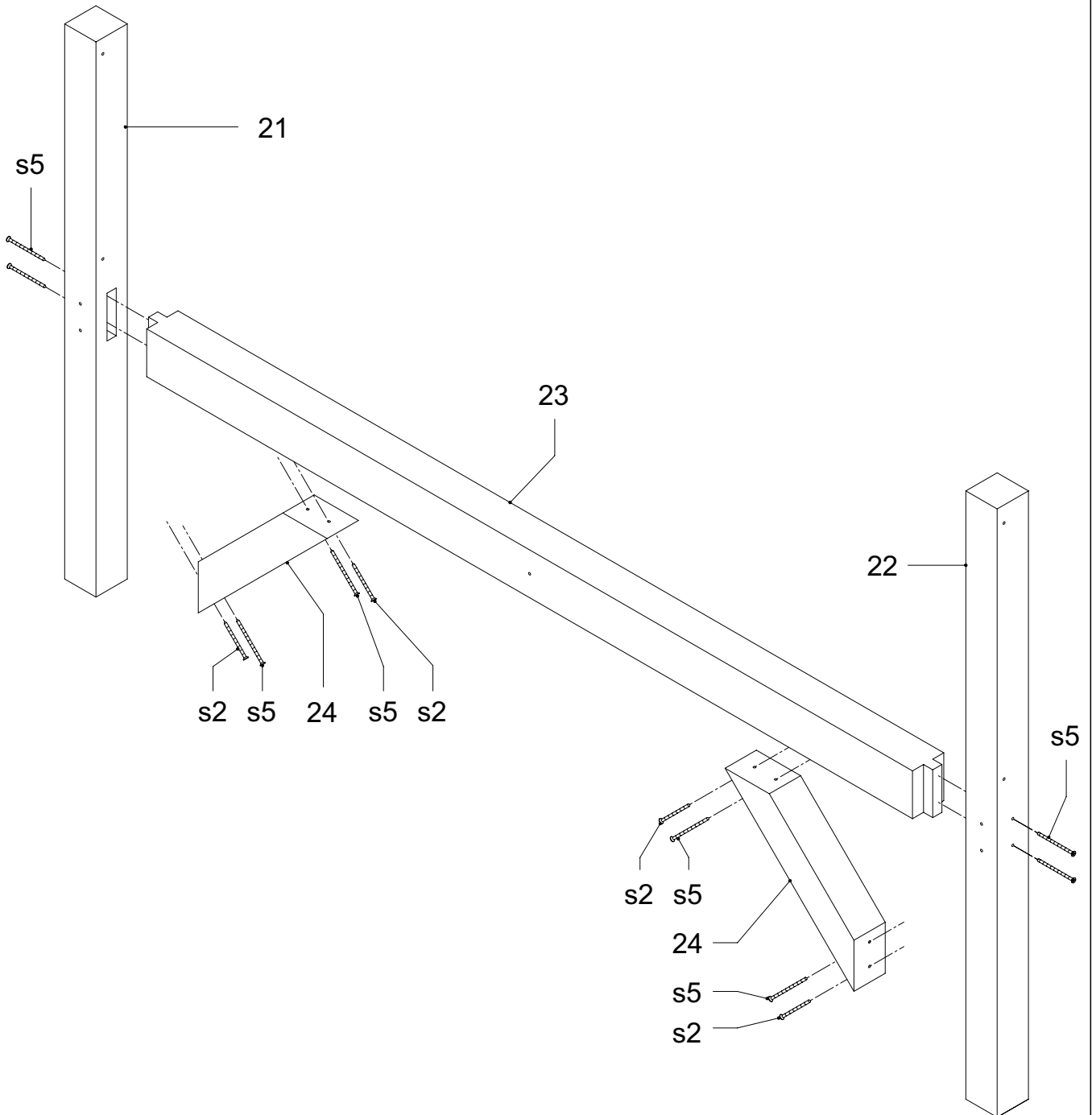



25	26	27	29	24 2x	s5 10x	s2 4x

A030.122.XX

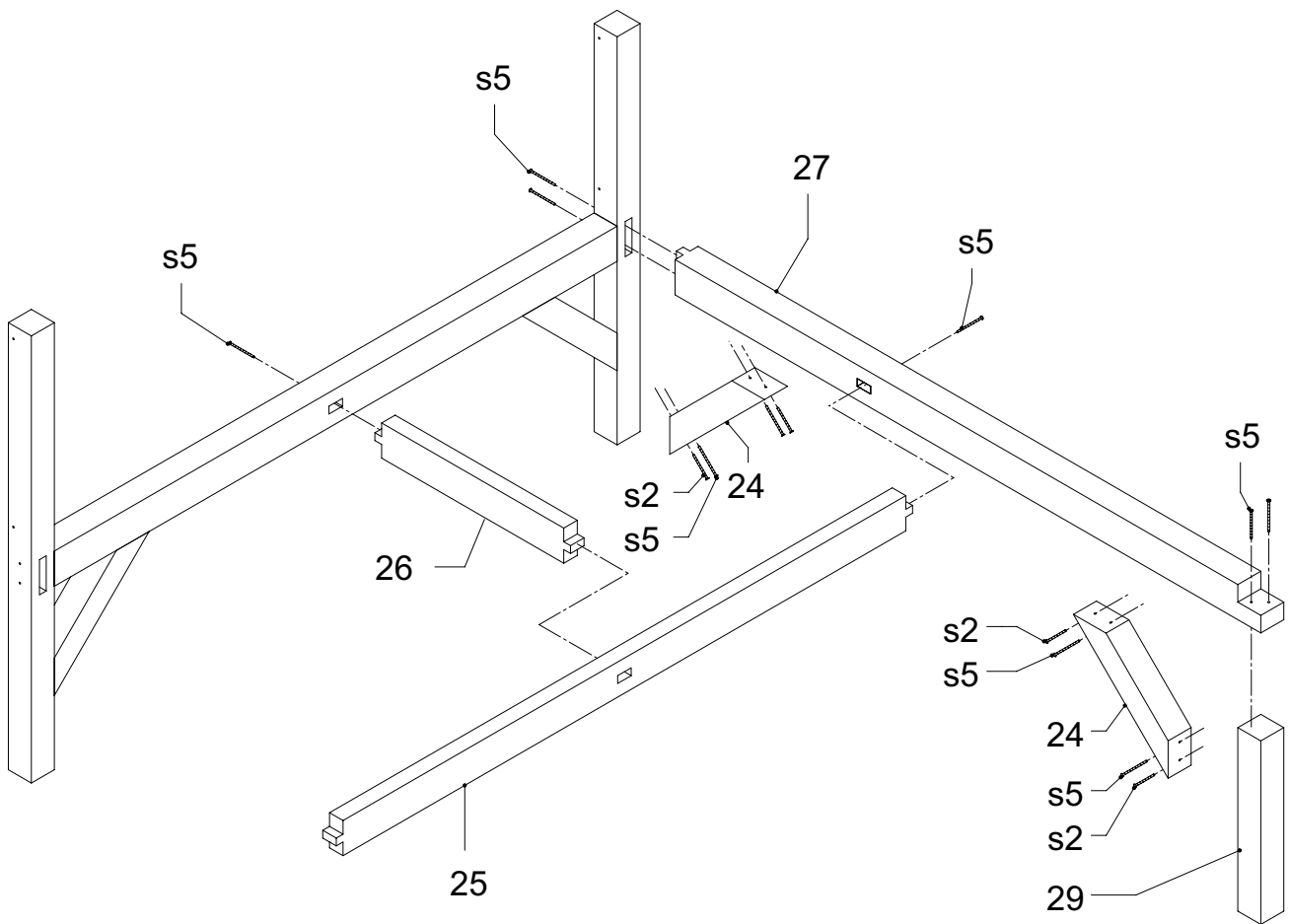



Emma

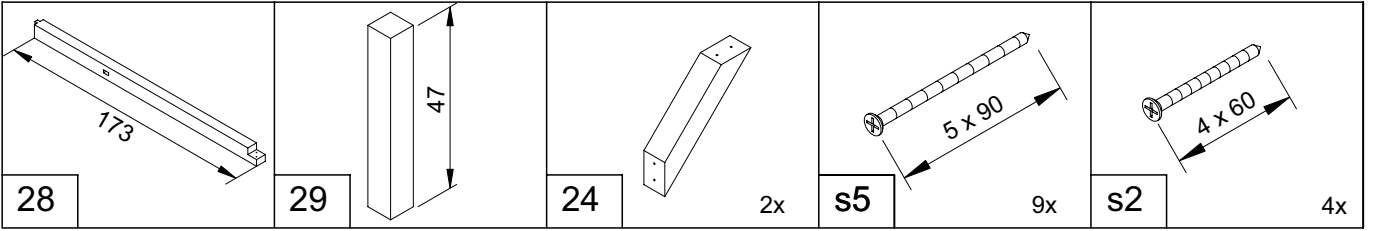

A030.122.XX

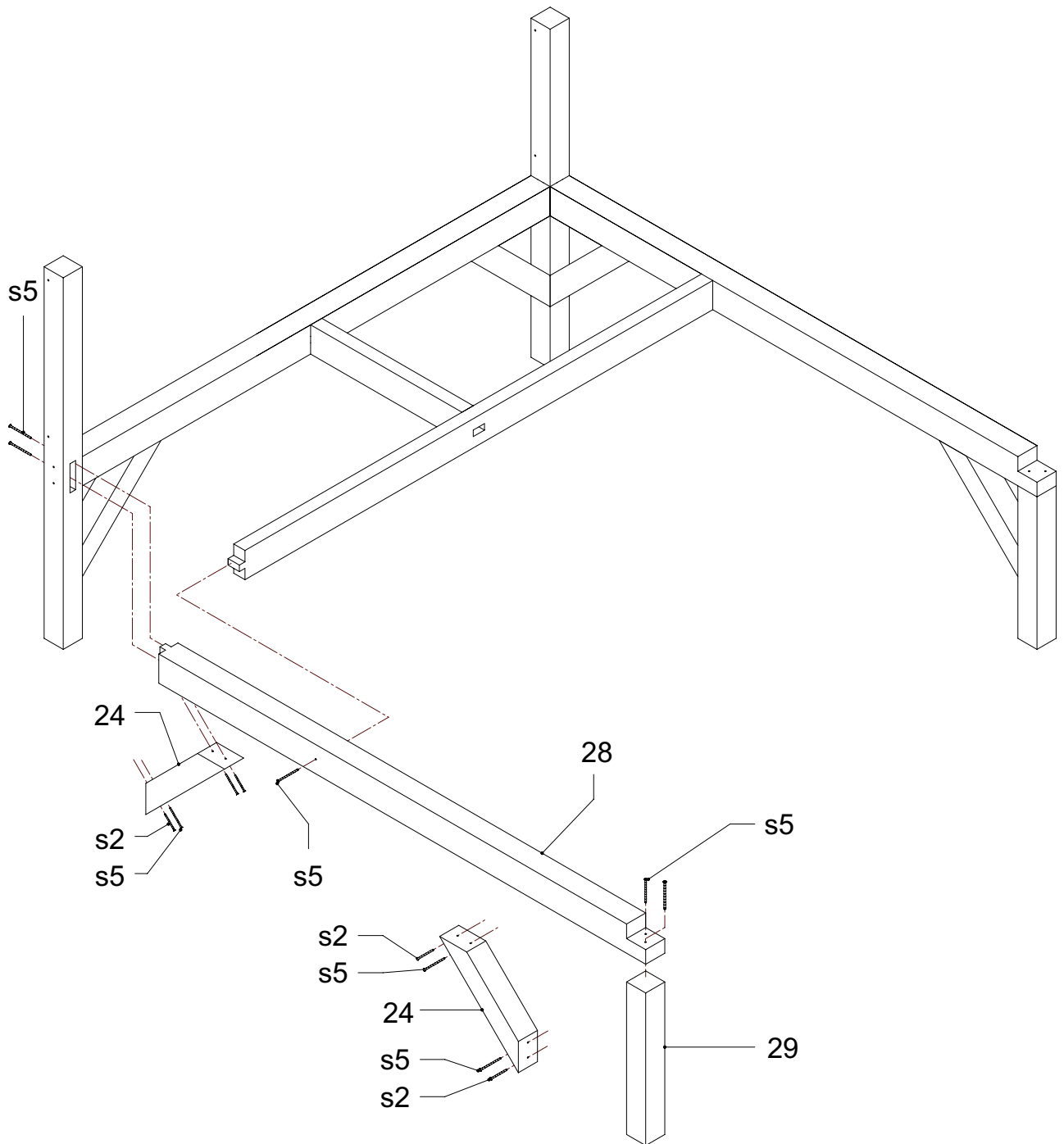



Emma

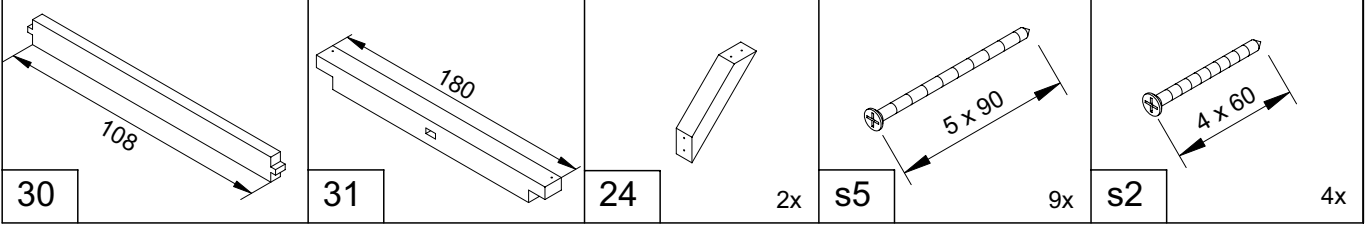

A030.122.XX

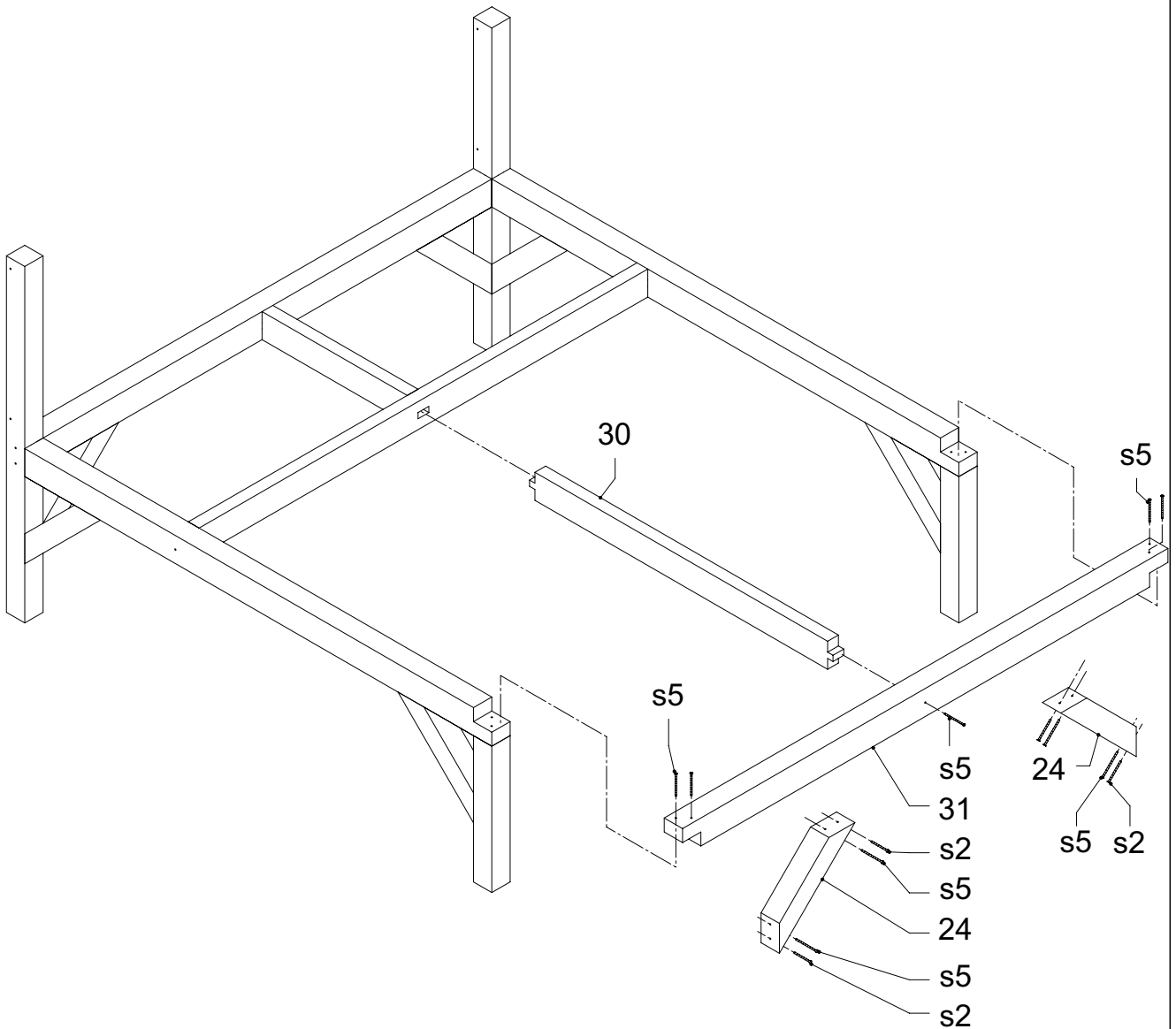

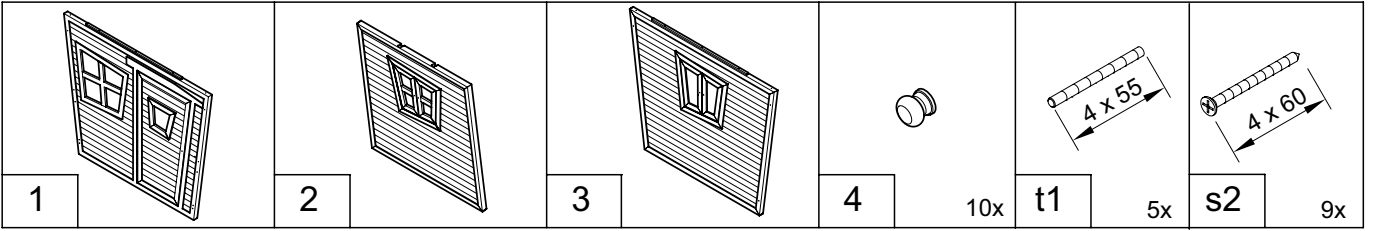

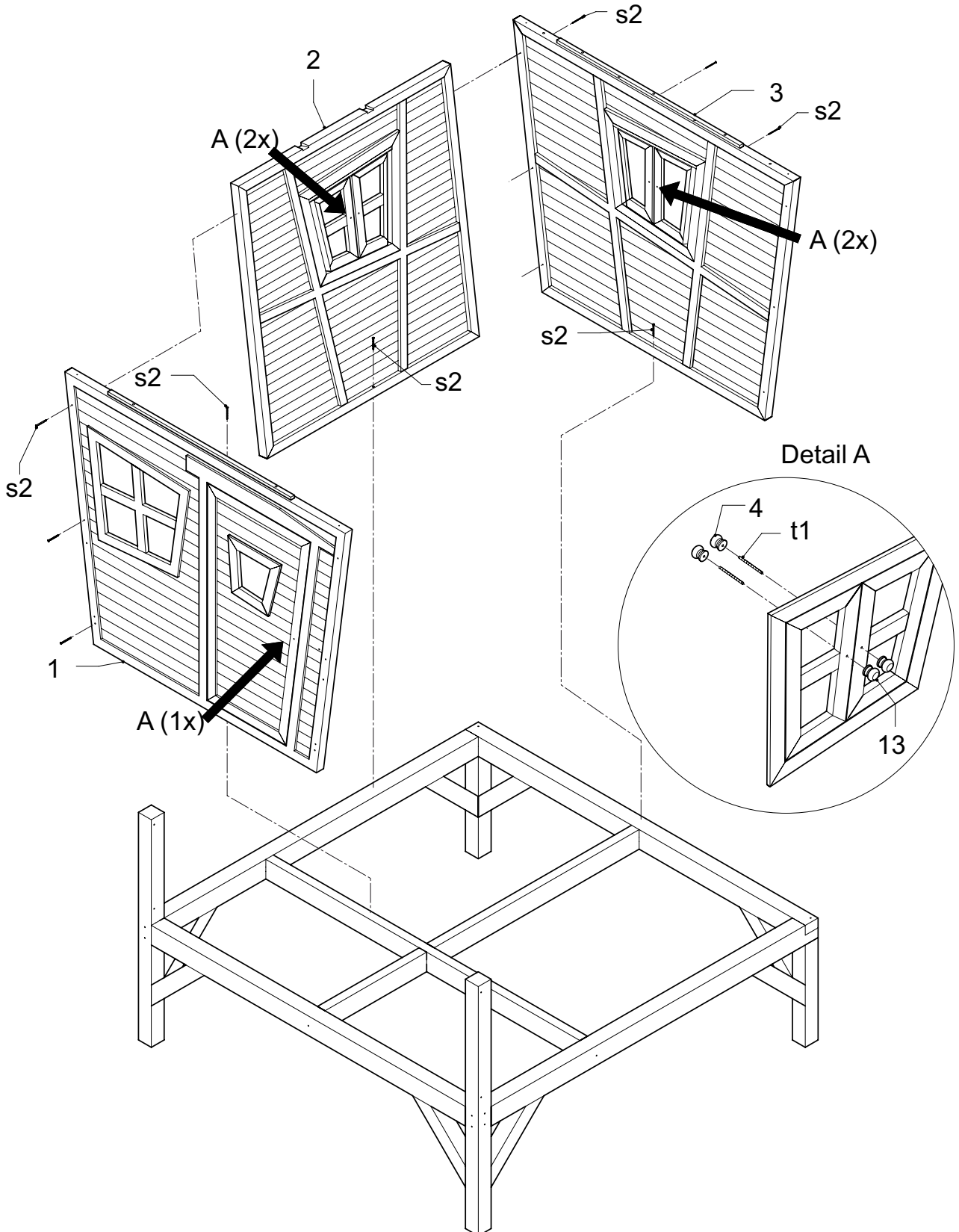

A030.111.XX + A030.117.XX



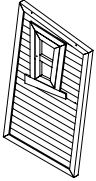
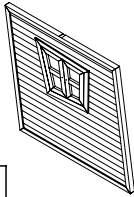
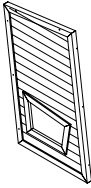

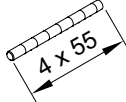
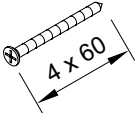
								
14	15	16	13	6x	t1	3x	s2	6x

A030.117.XX + A030.118.XX

Detail A

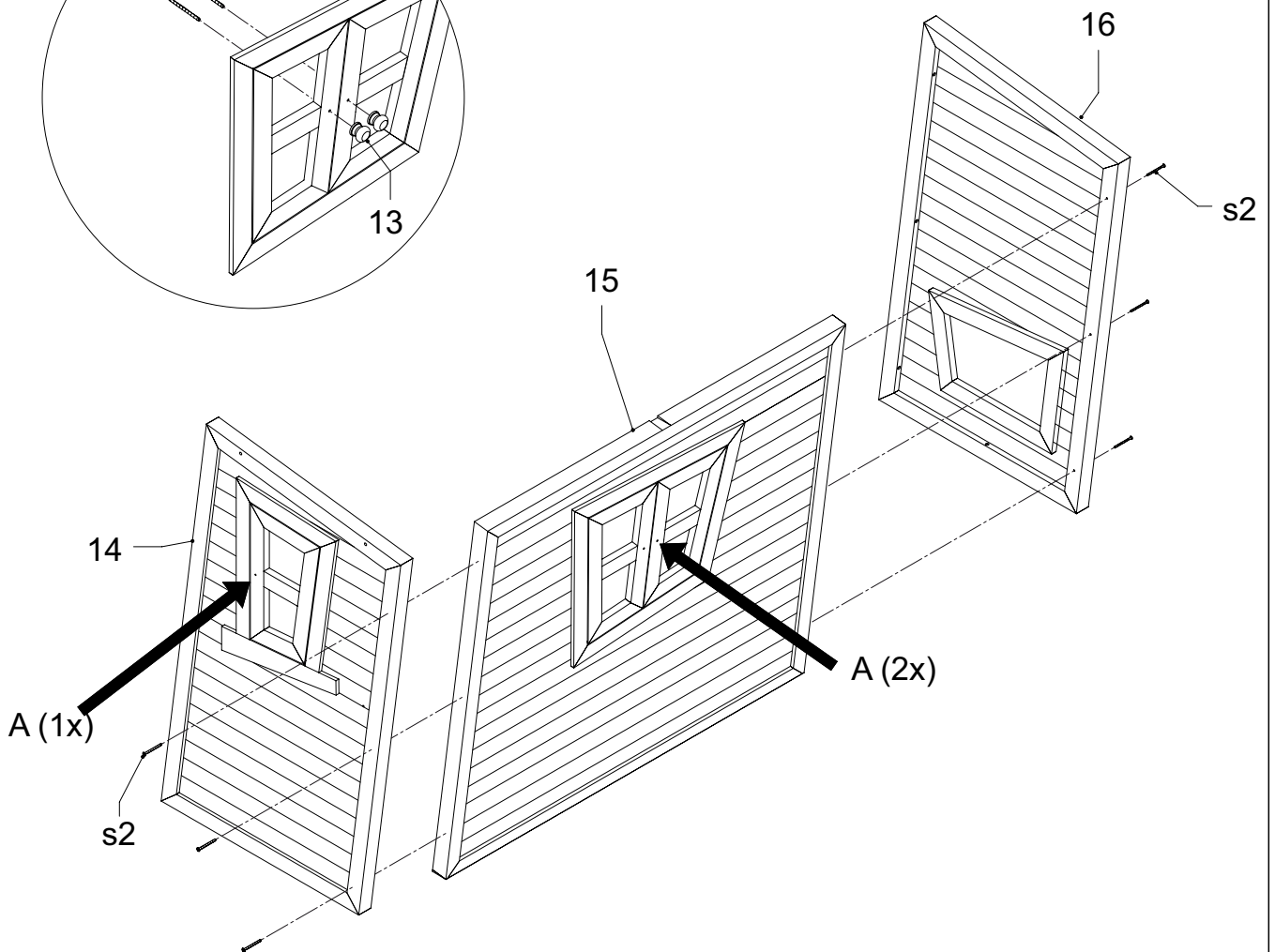
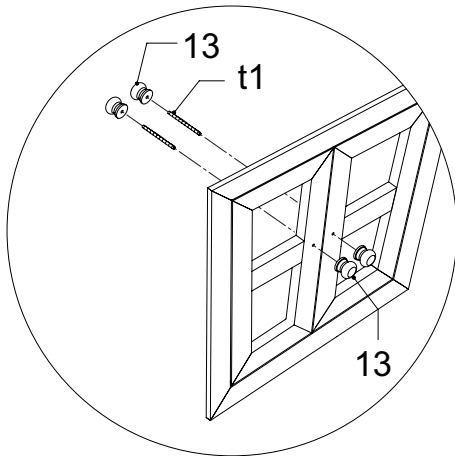

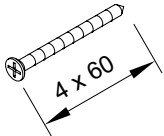

s2

9x

A030.118.XX

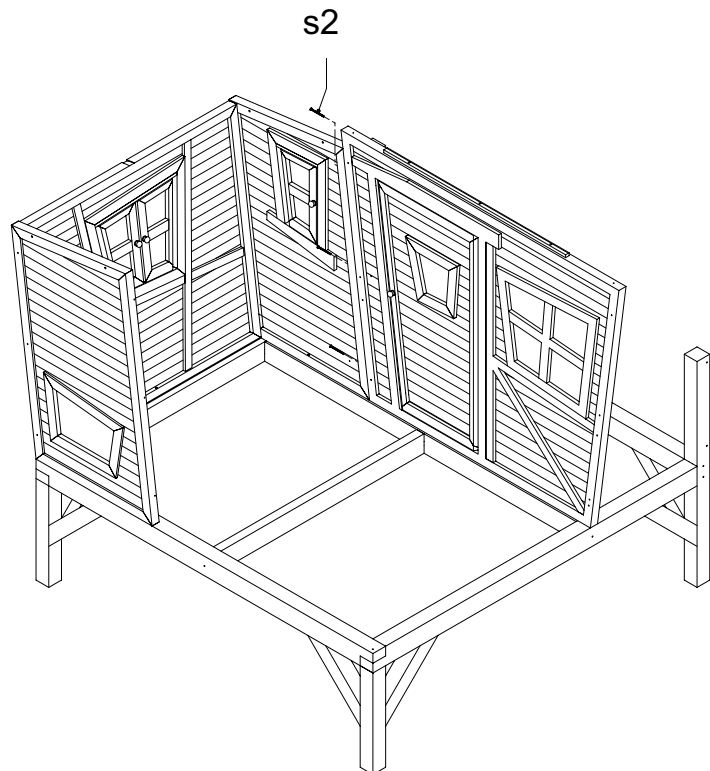
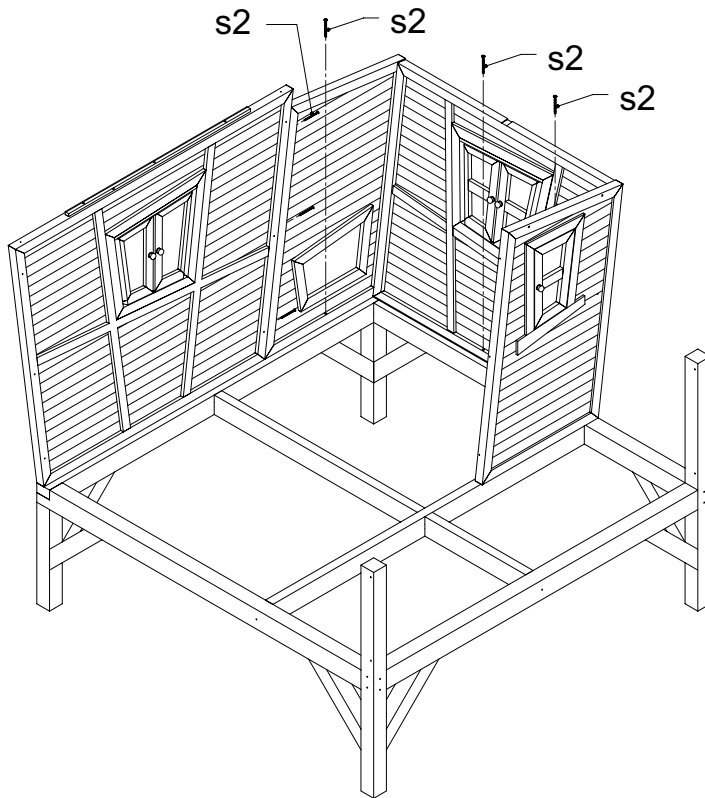

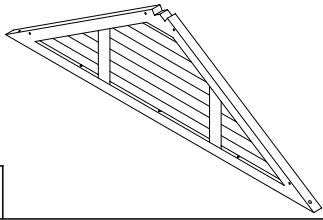

8

2x

s2

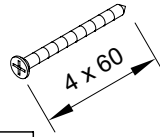

10x

A030.111.XX

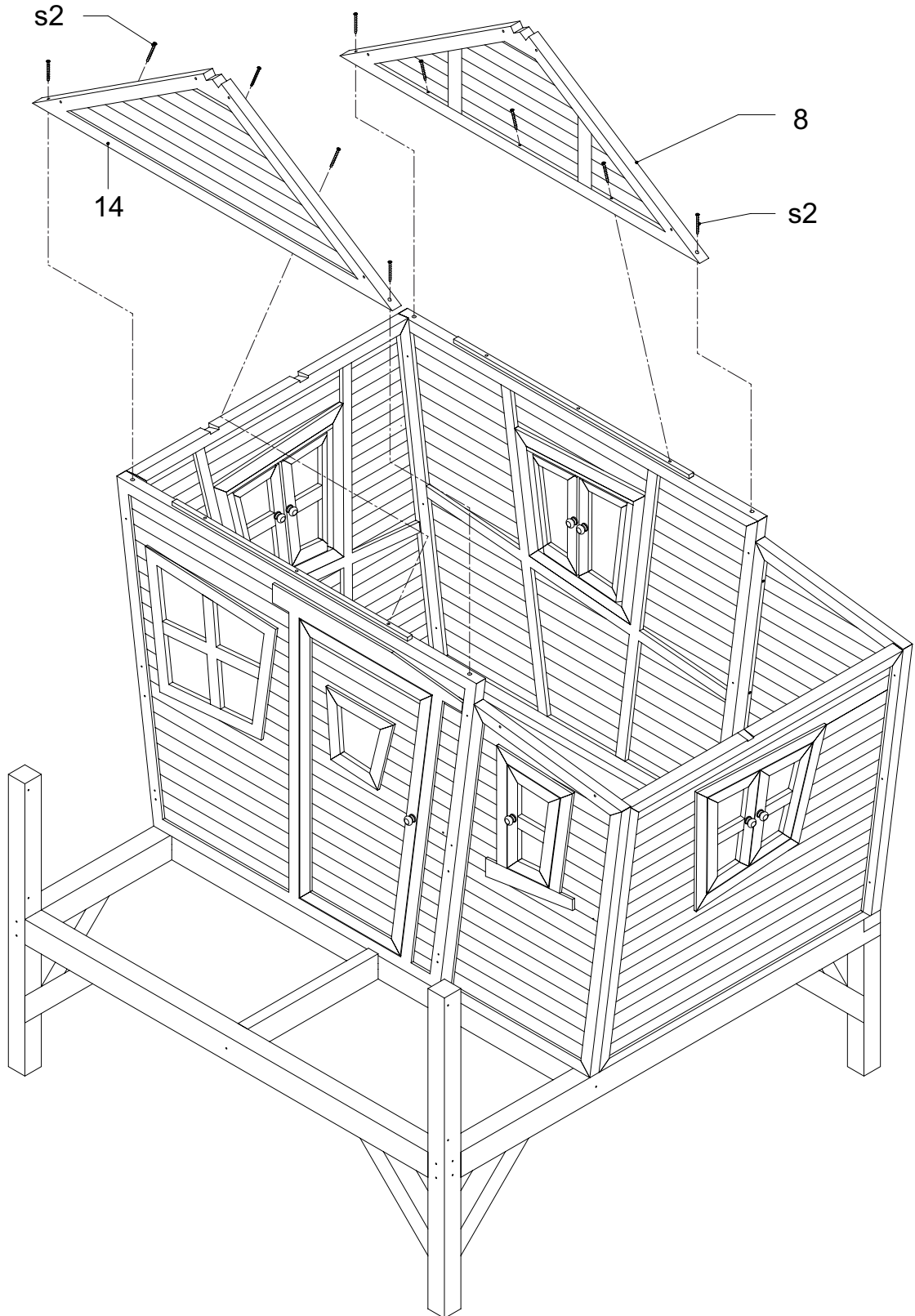

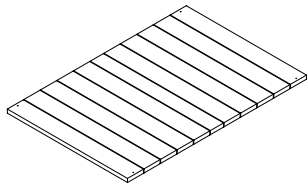

10

2x

S1

8x

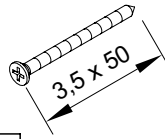

A030.142.XX

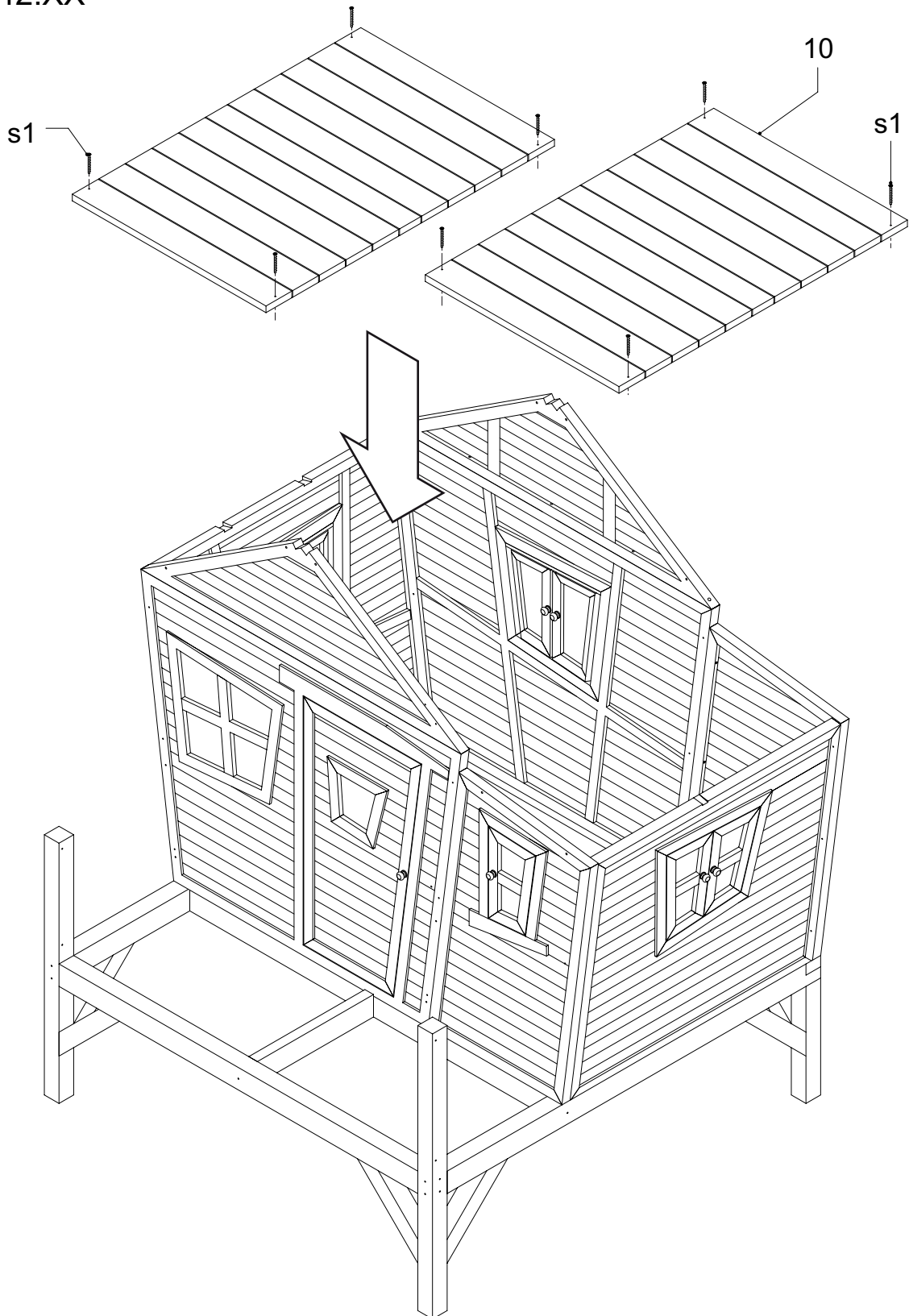

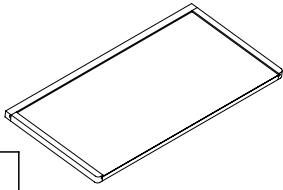

11

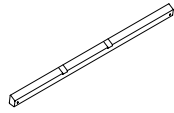

12

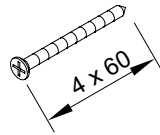

s2

6x

A030.118.XX

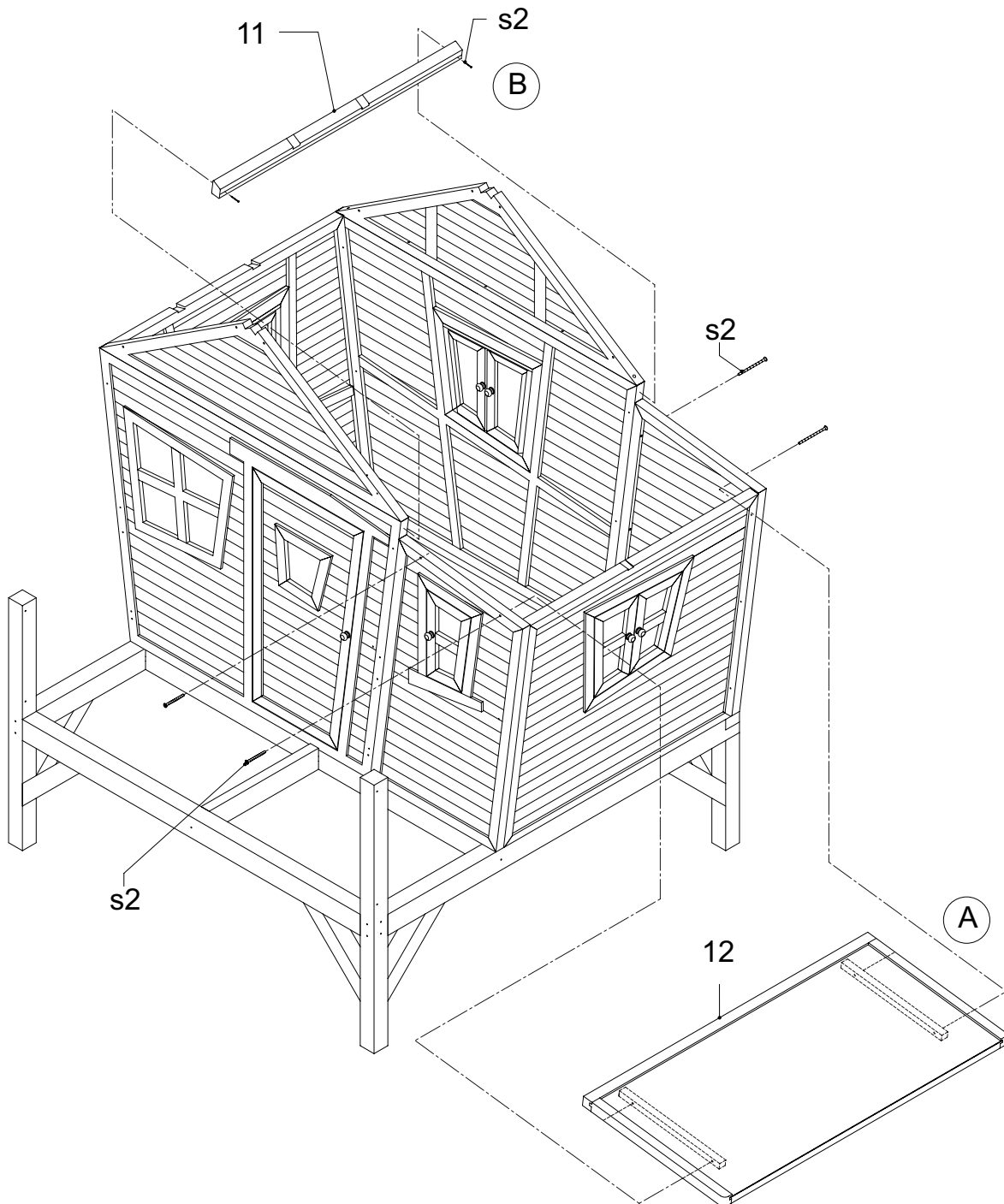



13	14	15	16	17	17A	17B	18	s3 16x	s6 6x

A030.113.XX

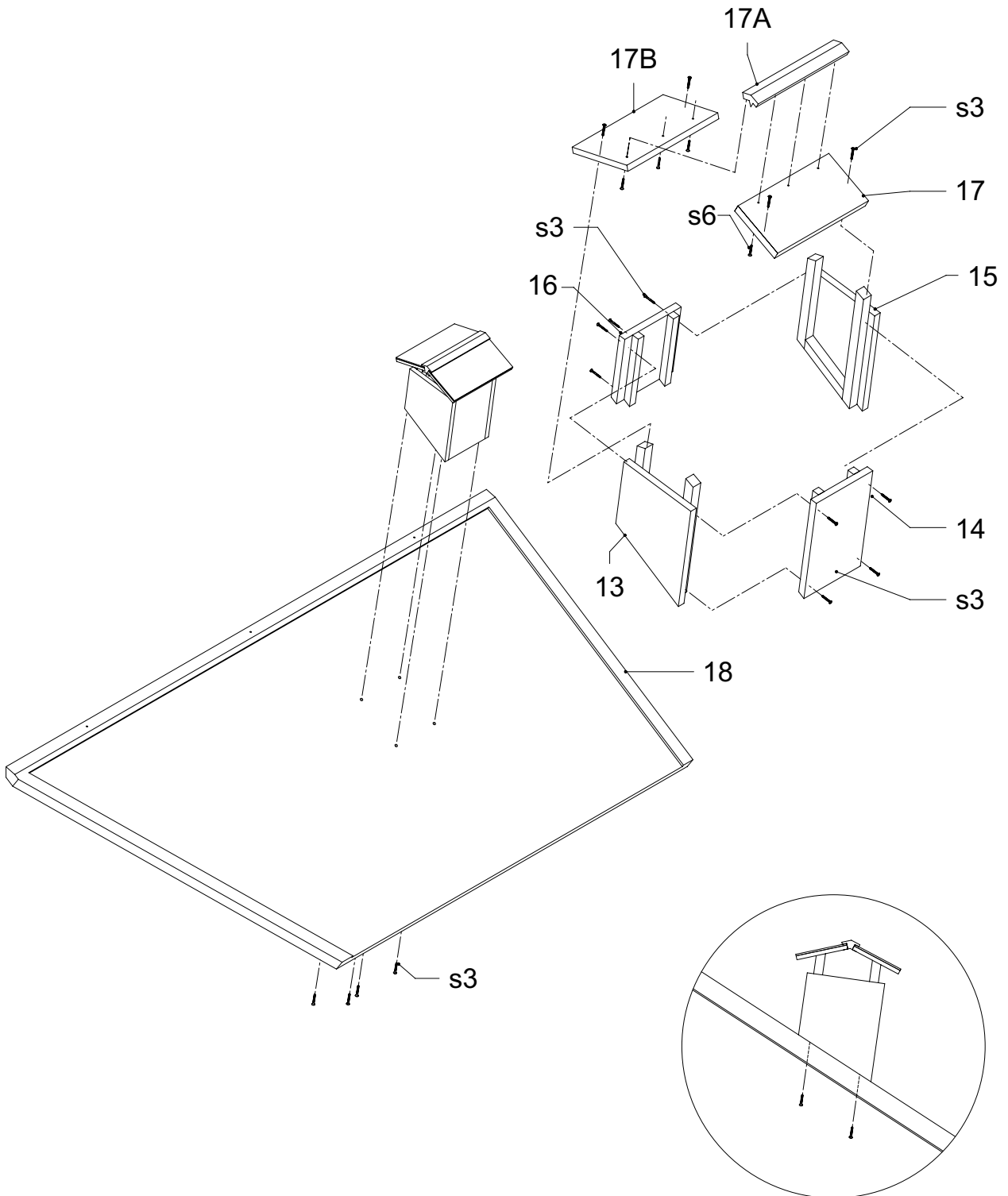

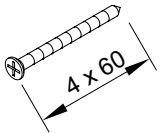

s2

4x

A030.113.XX

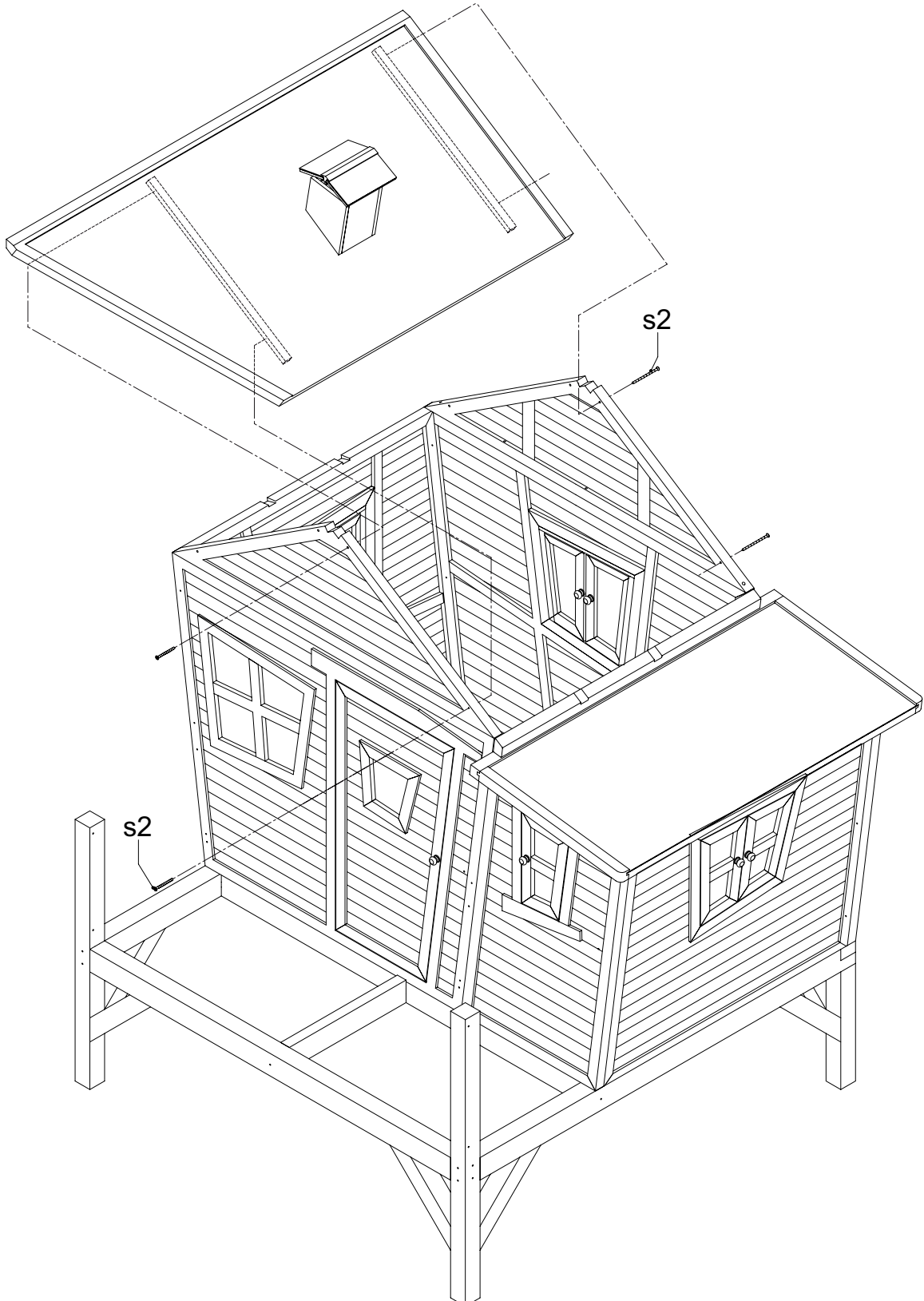

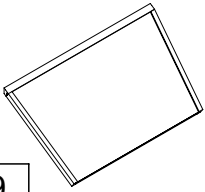

19

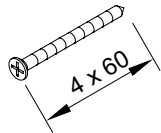

s2

4x

A030.113.XX

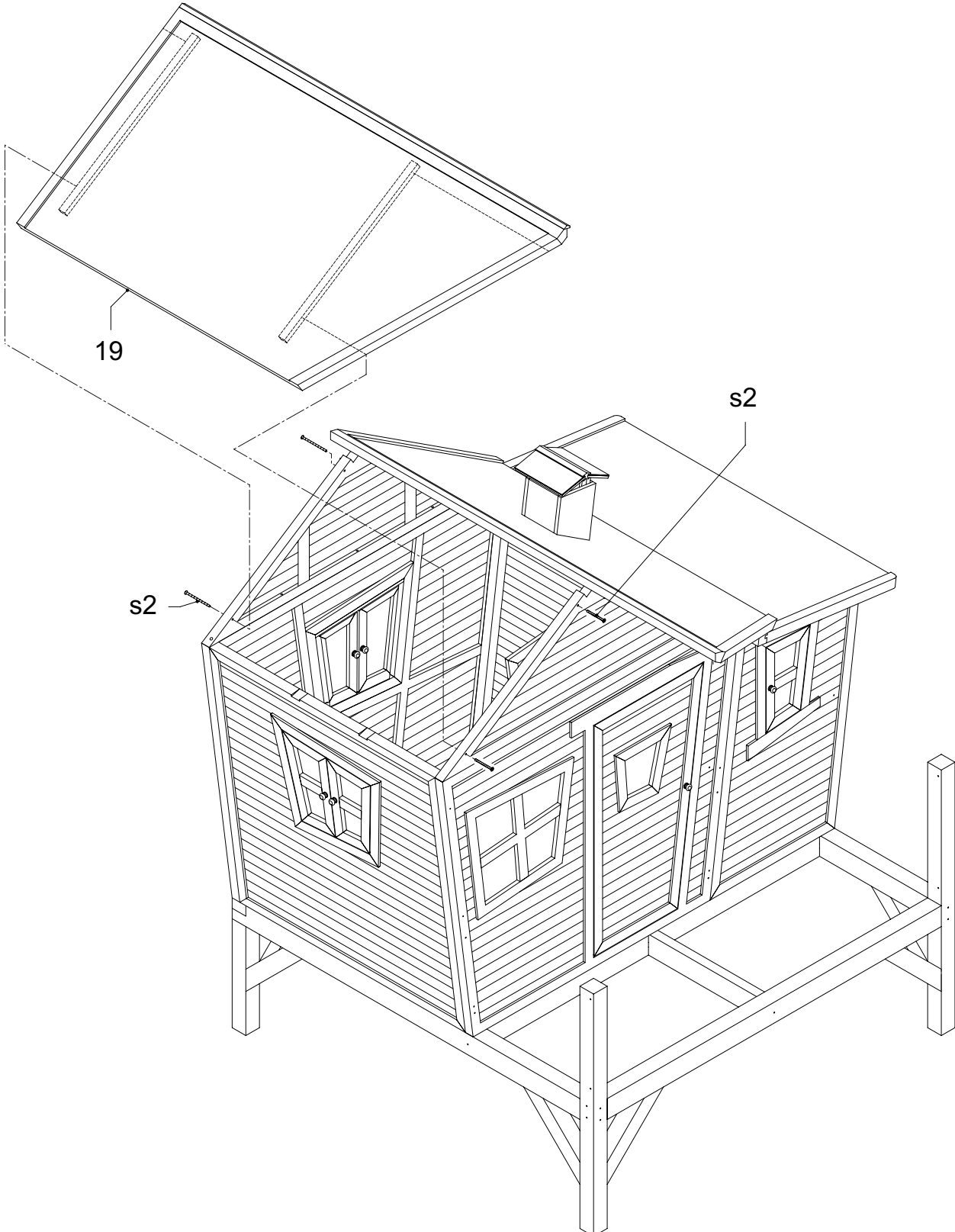



20

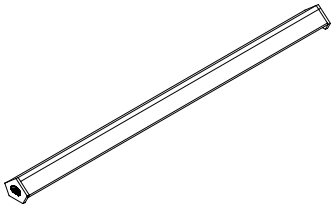

s4

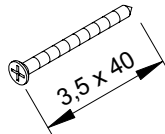

15x

A030.113.XX

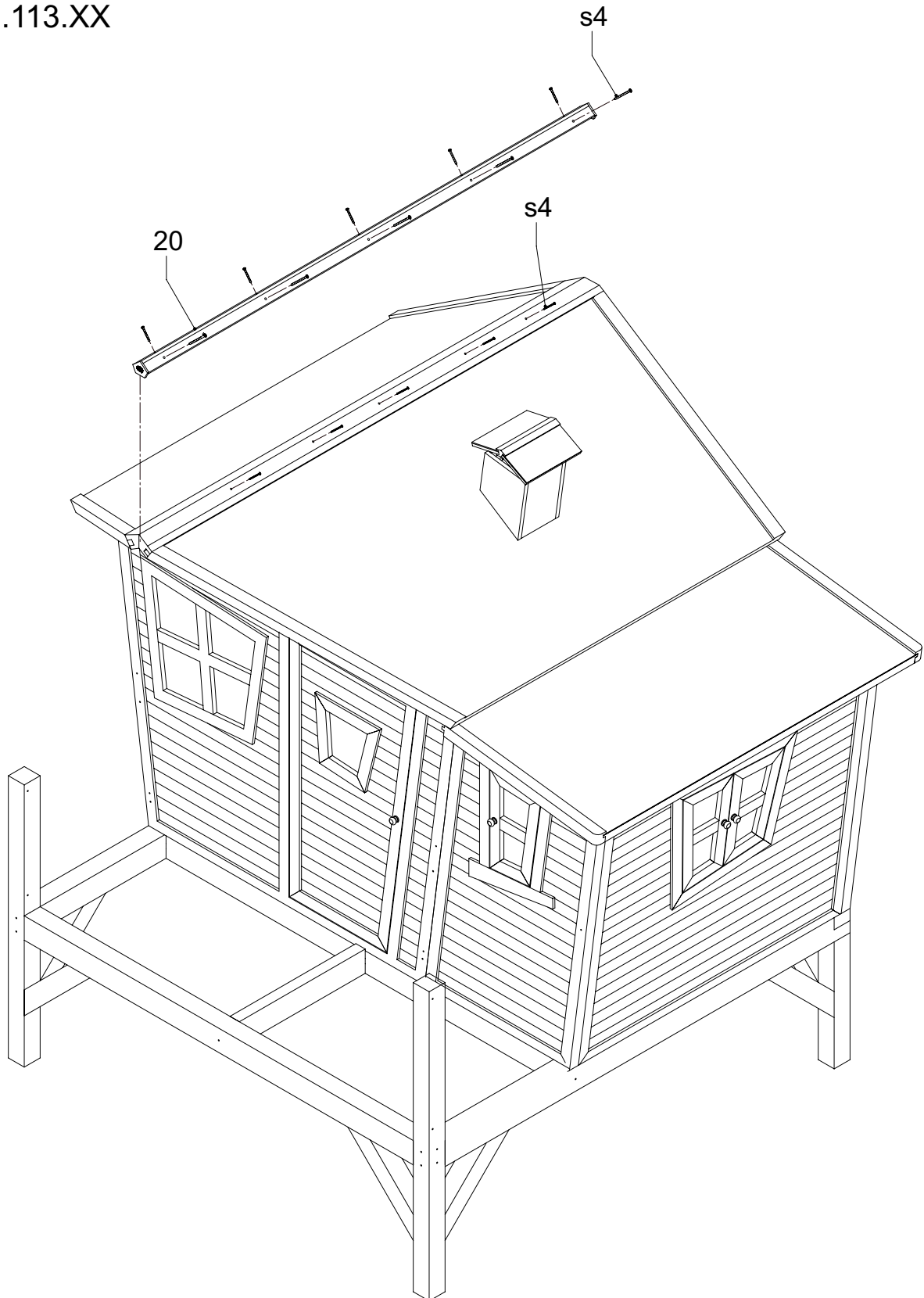



Emma

32						16x		2x		4x
32A		33	34	35	s1		s2		s7	

A039.060.XX + A030.121.XX + A030.122.XX

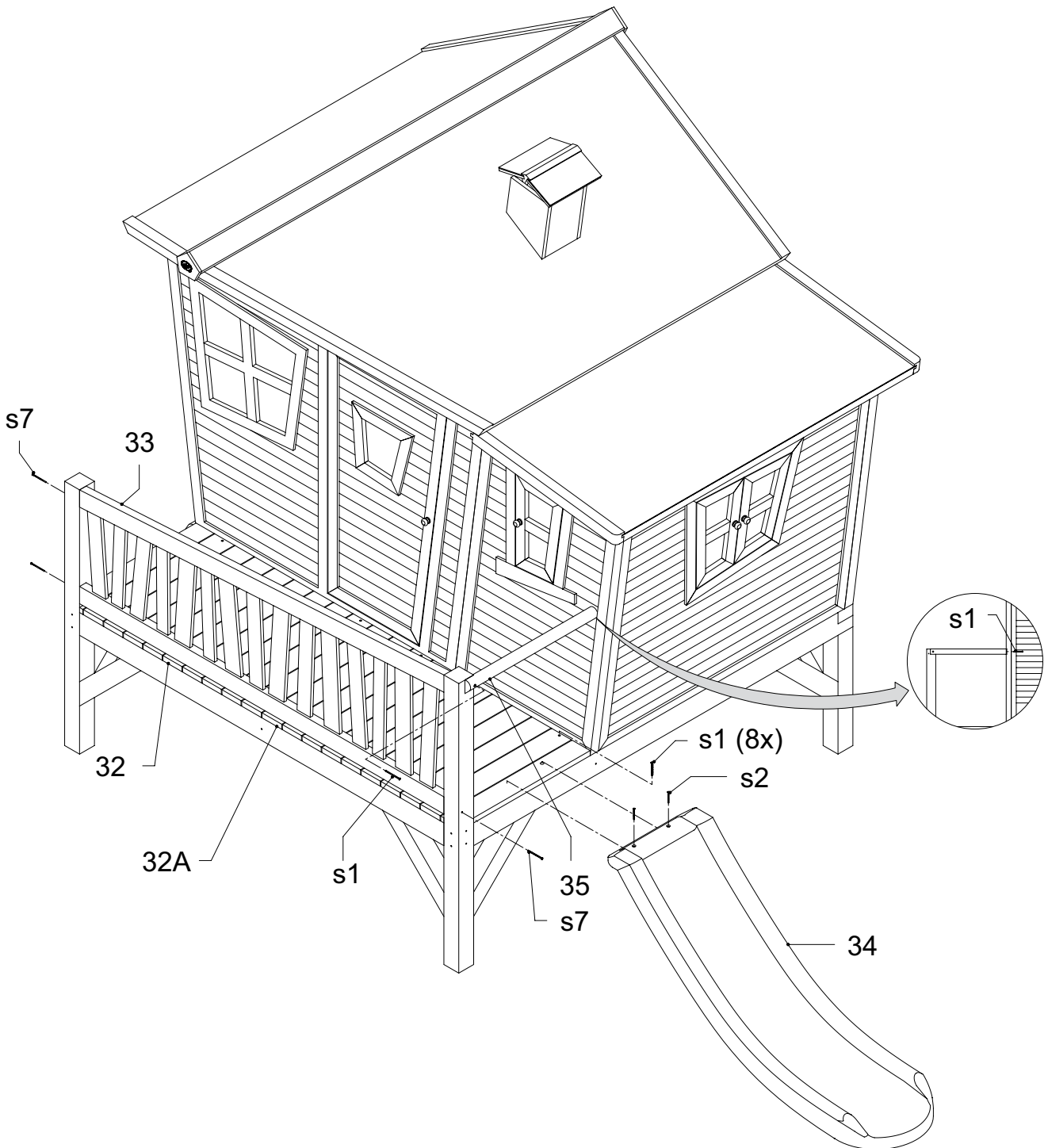



Emma

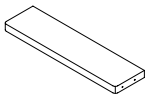

36

3x

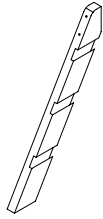

37

38

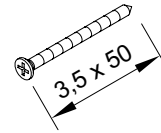
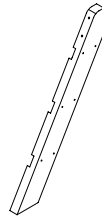

s1

12x

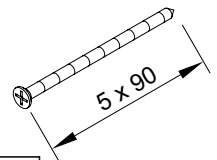

s5

4x

A030.122.XX

A

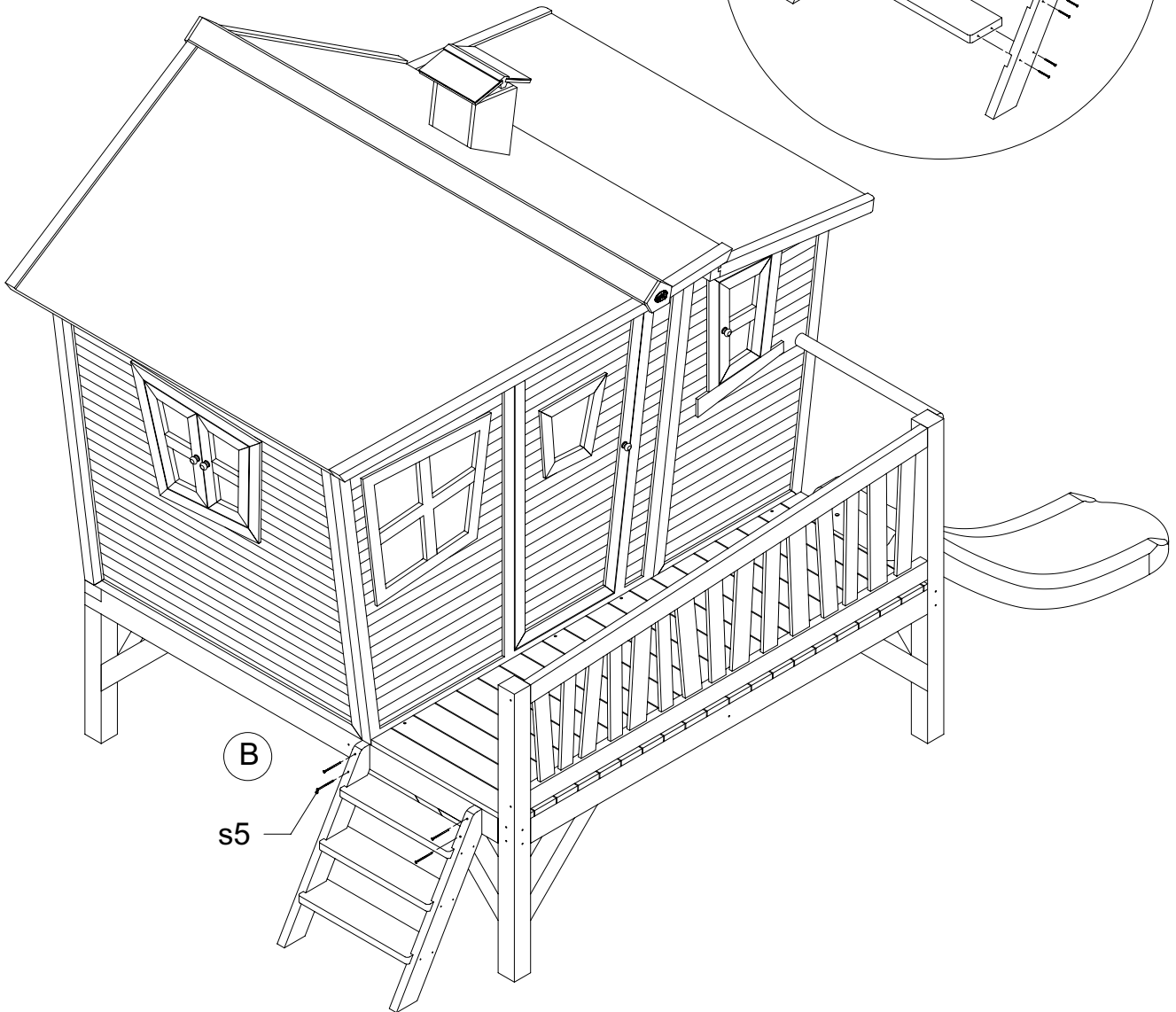
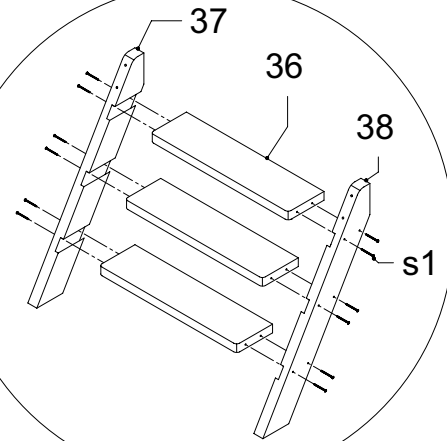

B

s5



Max

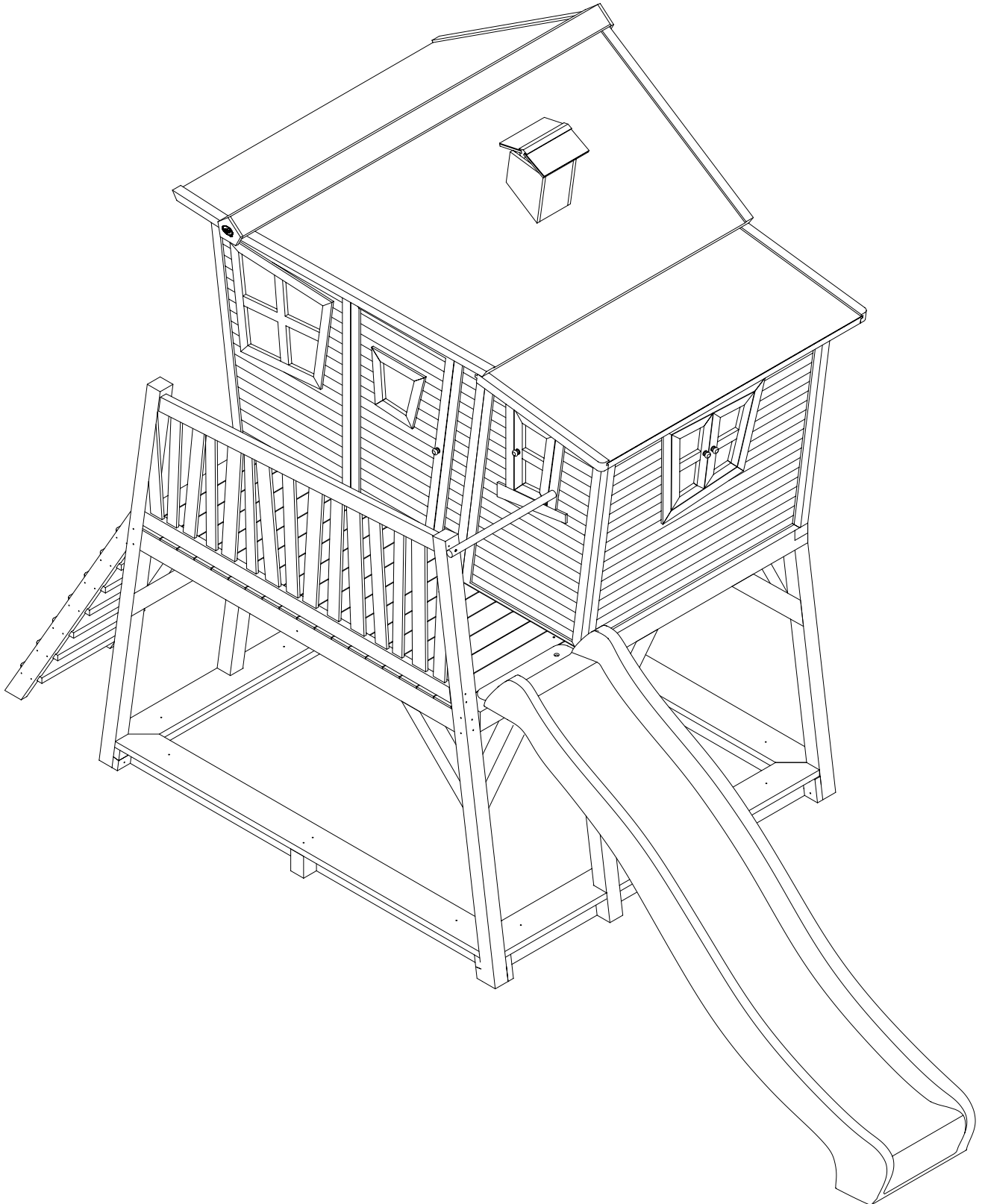



Max

A030.111.XX

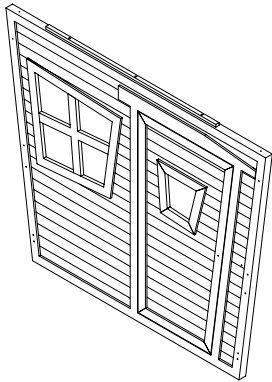

1

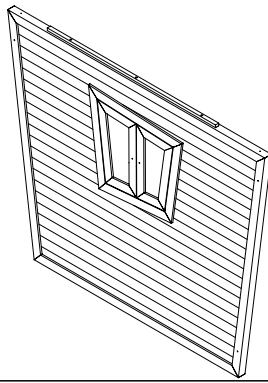

3



4

14x

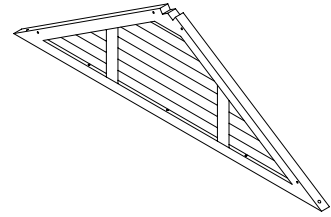

8

2x

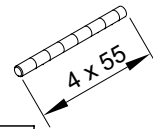

t1

7x

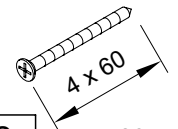

s2

26x

A030.113.XX

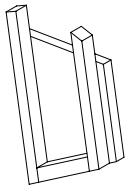

12

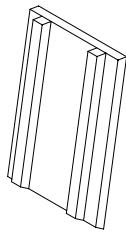

13

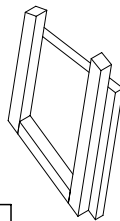

14

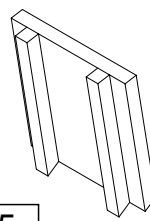

15

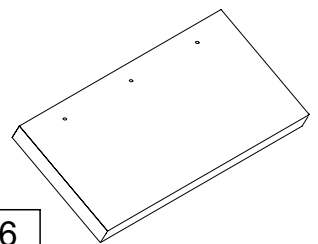

16

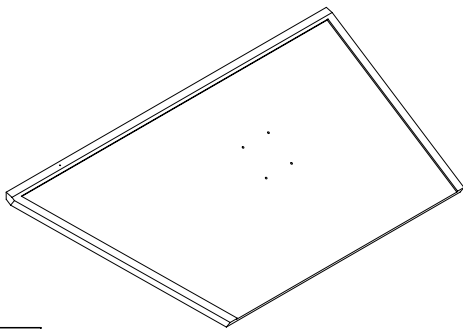

17

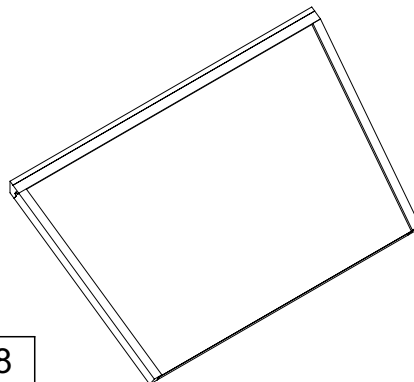

18

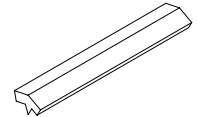

16A

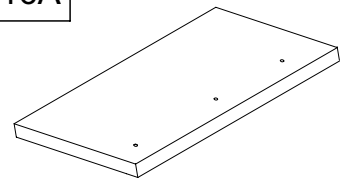

16B

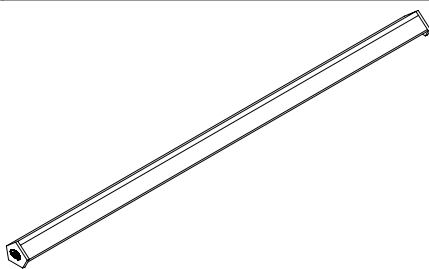

19

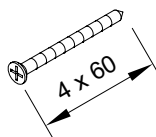

s2

8x

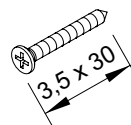

s3

16x

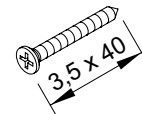

s4

15x



s6

6x

A030.117.00

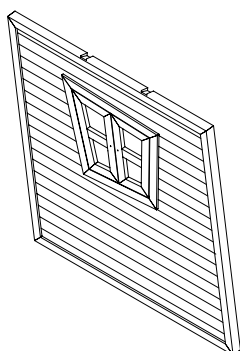

2

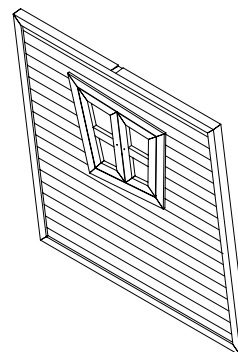

6



Max

A030.118.XX

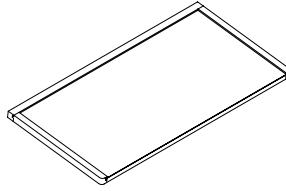
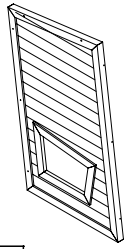
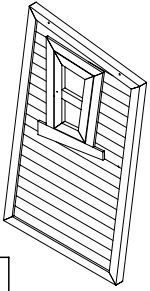

10

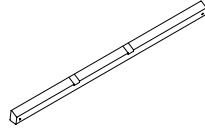

11

4



2x

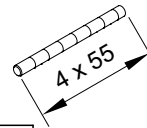

t1

1x

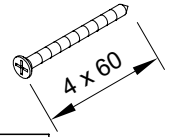

s2

14x

5

7

A030.155.XX

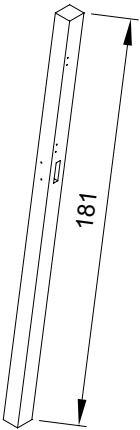

20

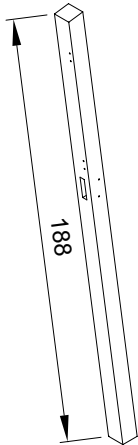

21

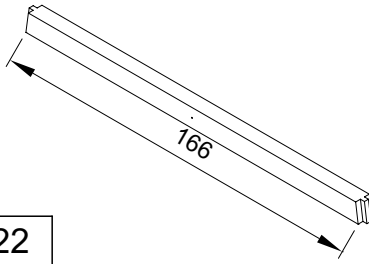

22

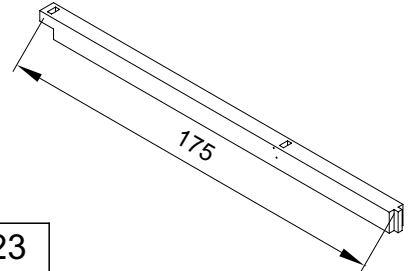

23

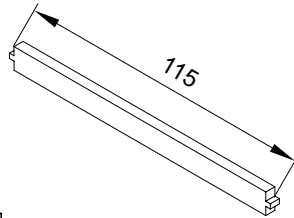

27

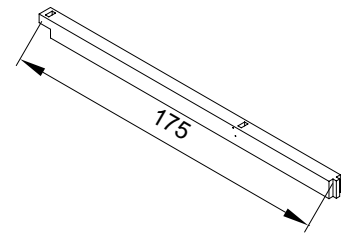

28

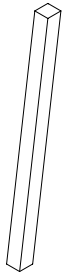

24

4x

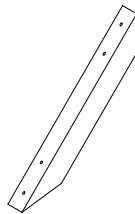

25

2x

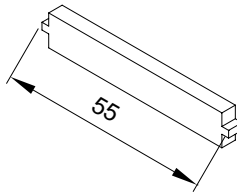

26

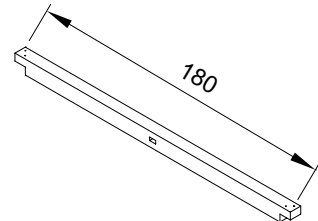

29

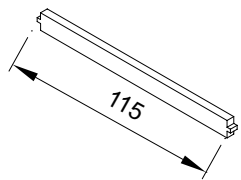

30

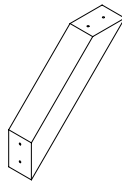

31A

4x

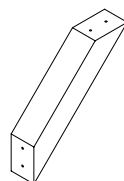

31B

3x

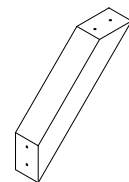

31C

3x

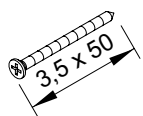

s1

34x

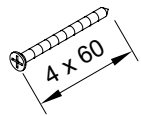

s2

24x

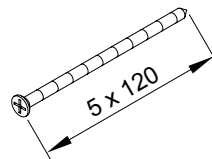

s7

2x

42

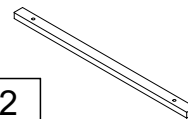

3x

41

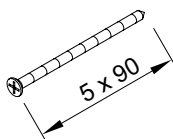
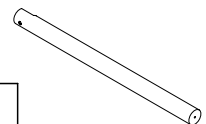

s5

48x

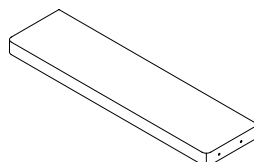

43

7x

44

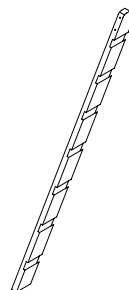

45

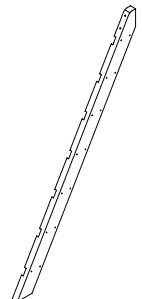



Max

A030.142.XX

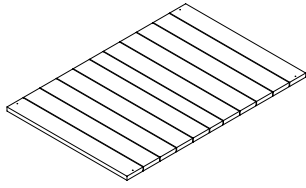

9

2x

40

A039.120.XX

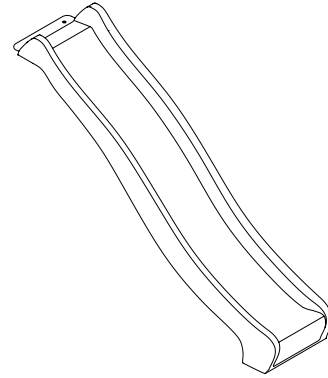

A030.157.XX

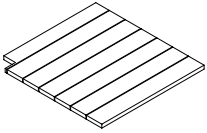

38

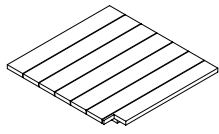

38A

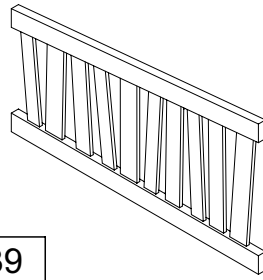

39

s1

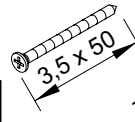

18x

s2

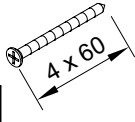

2x

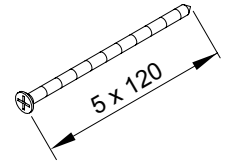

s7

4x

A030.159.00

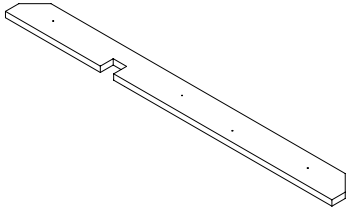

32

2x

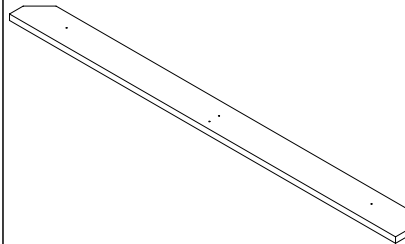

33

2x

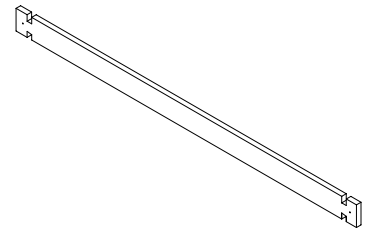

34

2x

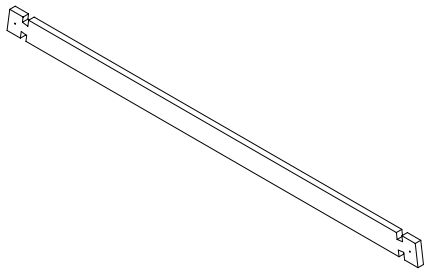

34A

2x

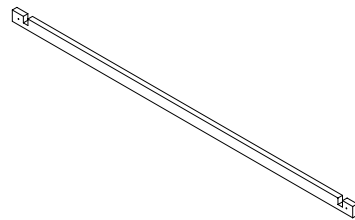

35

2x

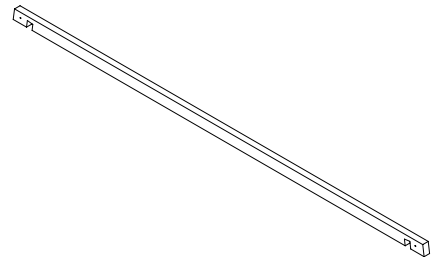

35A

2x

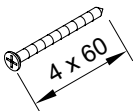

s2

44x

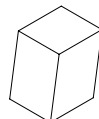

36

2x

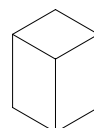

37

2x



Max

20	21	22	31A	2x s5	8x s2

A030.155.XX

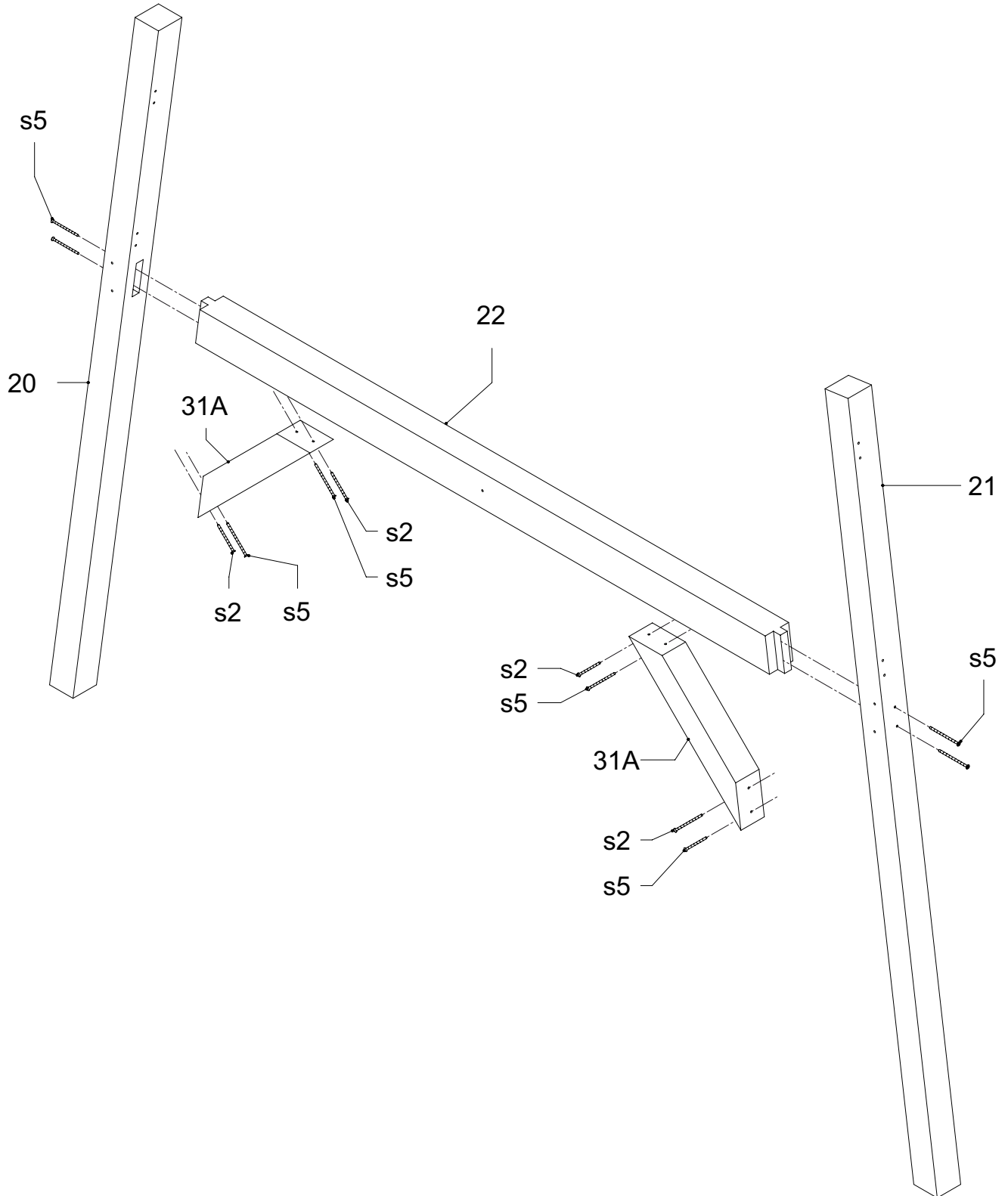

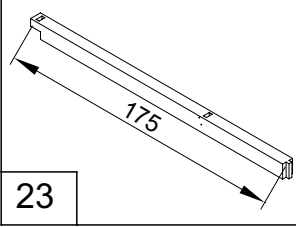
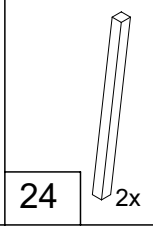
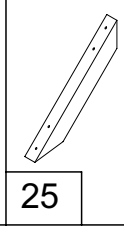
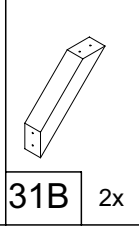
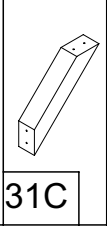
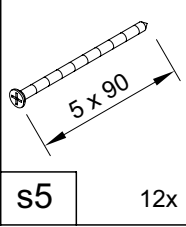
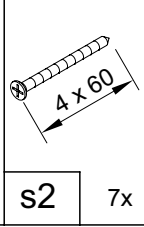
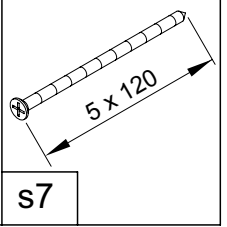

Max

							
23	24 2x	25	31B 2x	31C	s5 12x	s2 7x	s7

A030.155.XX

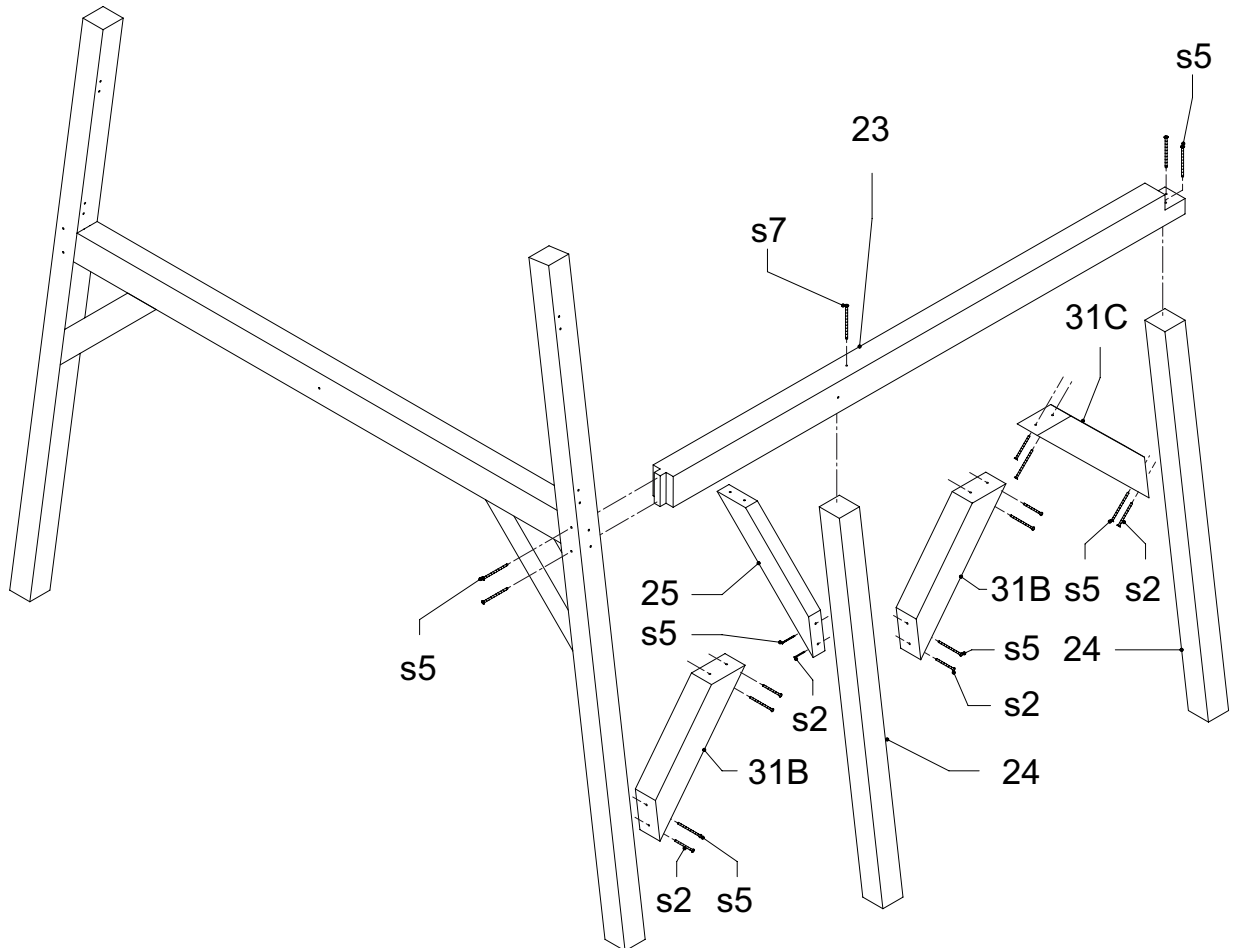



Max

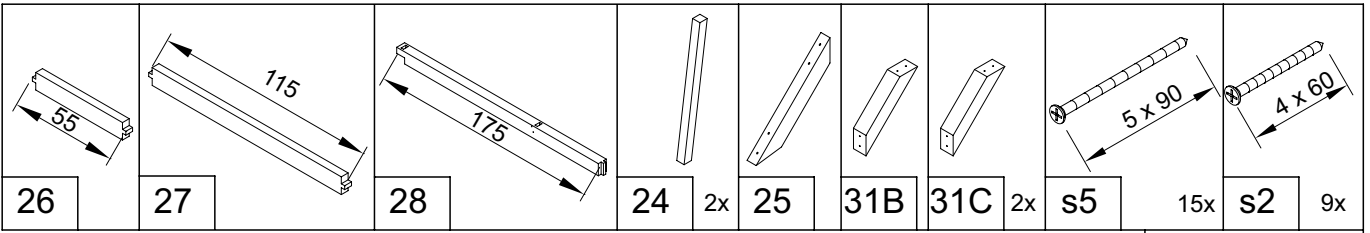

A030.155.XX

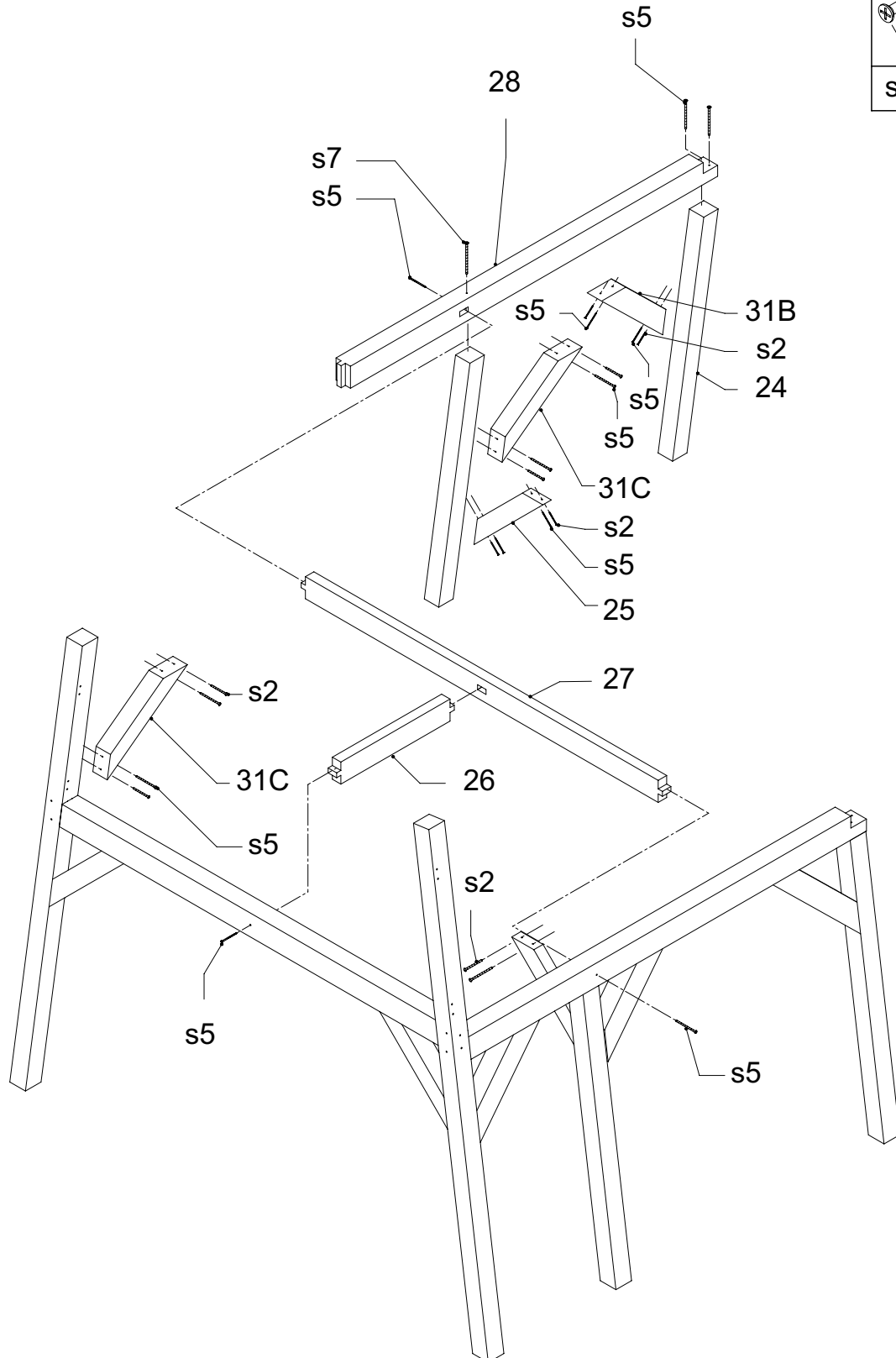



Max

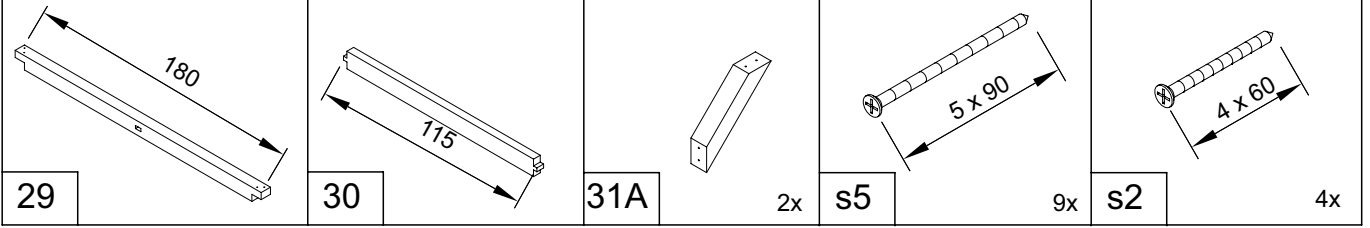



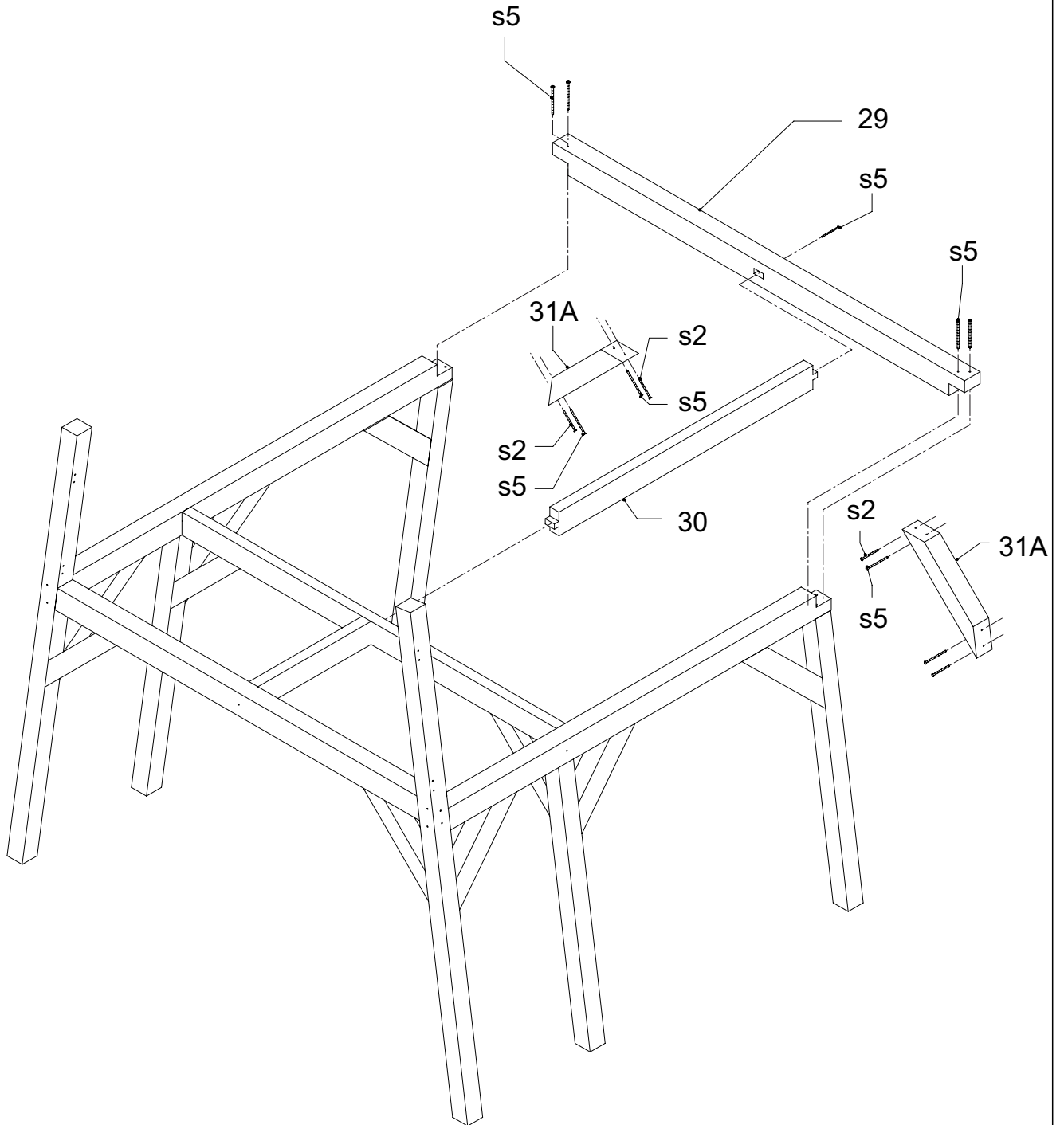

A030.155.XX



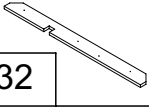
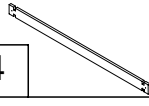
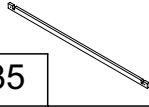

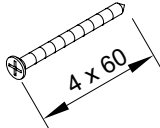
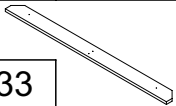
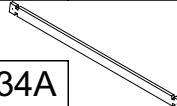
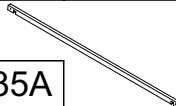
Max

 32	2x	 34	2x	 35	2x			 4 x 60	44x
 33	2x	 34A	2x	 35A	2x		2x		2x

A030.159.XX

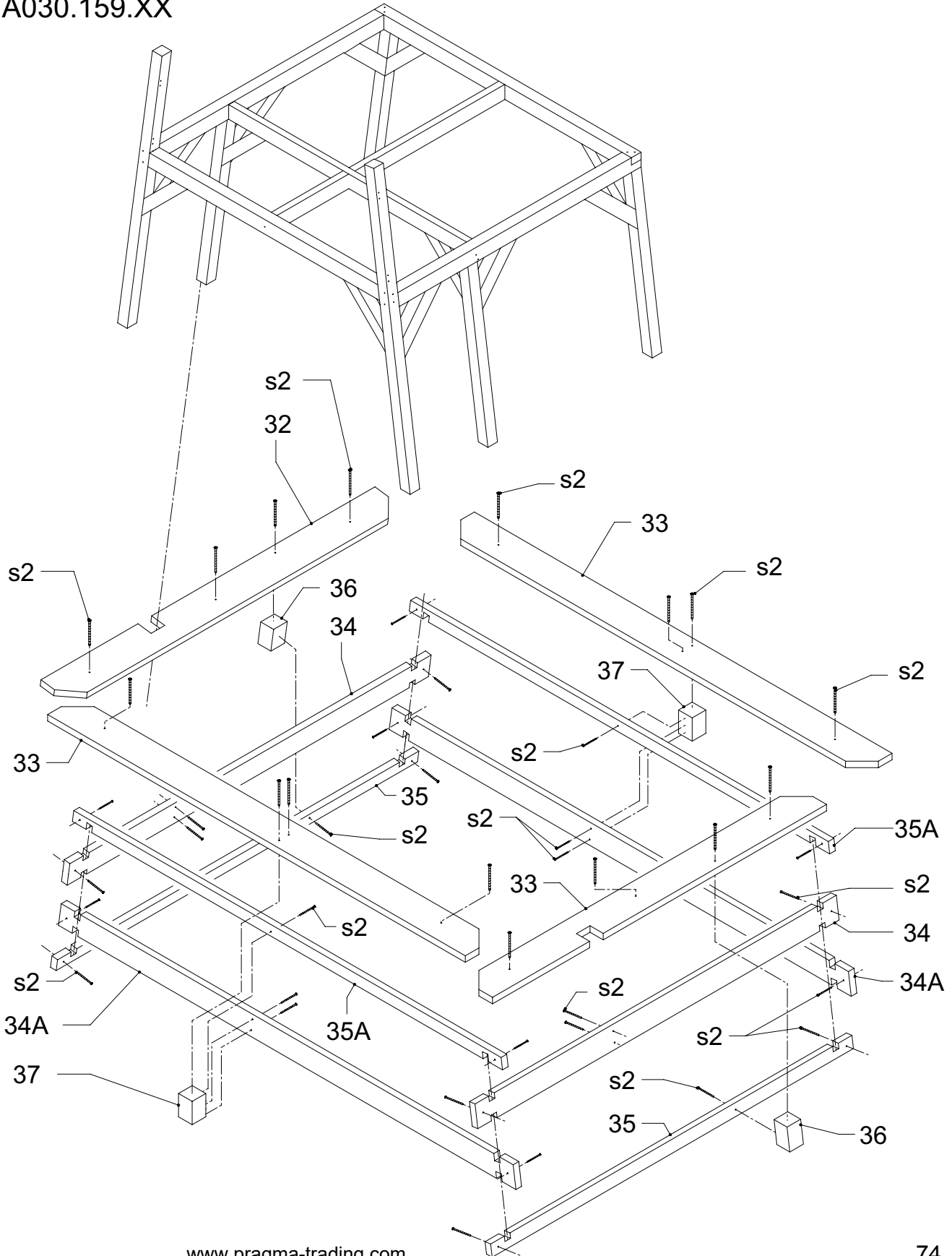



Max

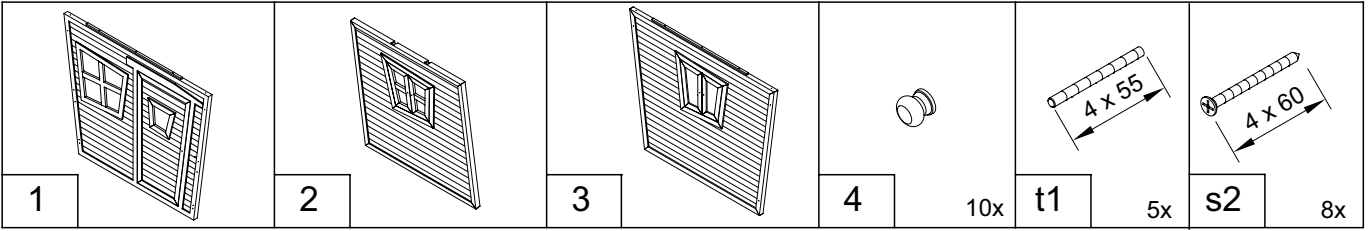

A030.111.XX + A030.117.XX

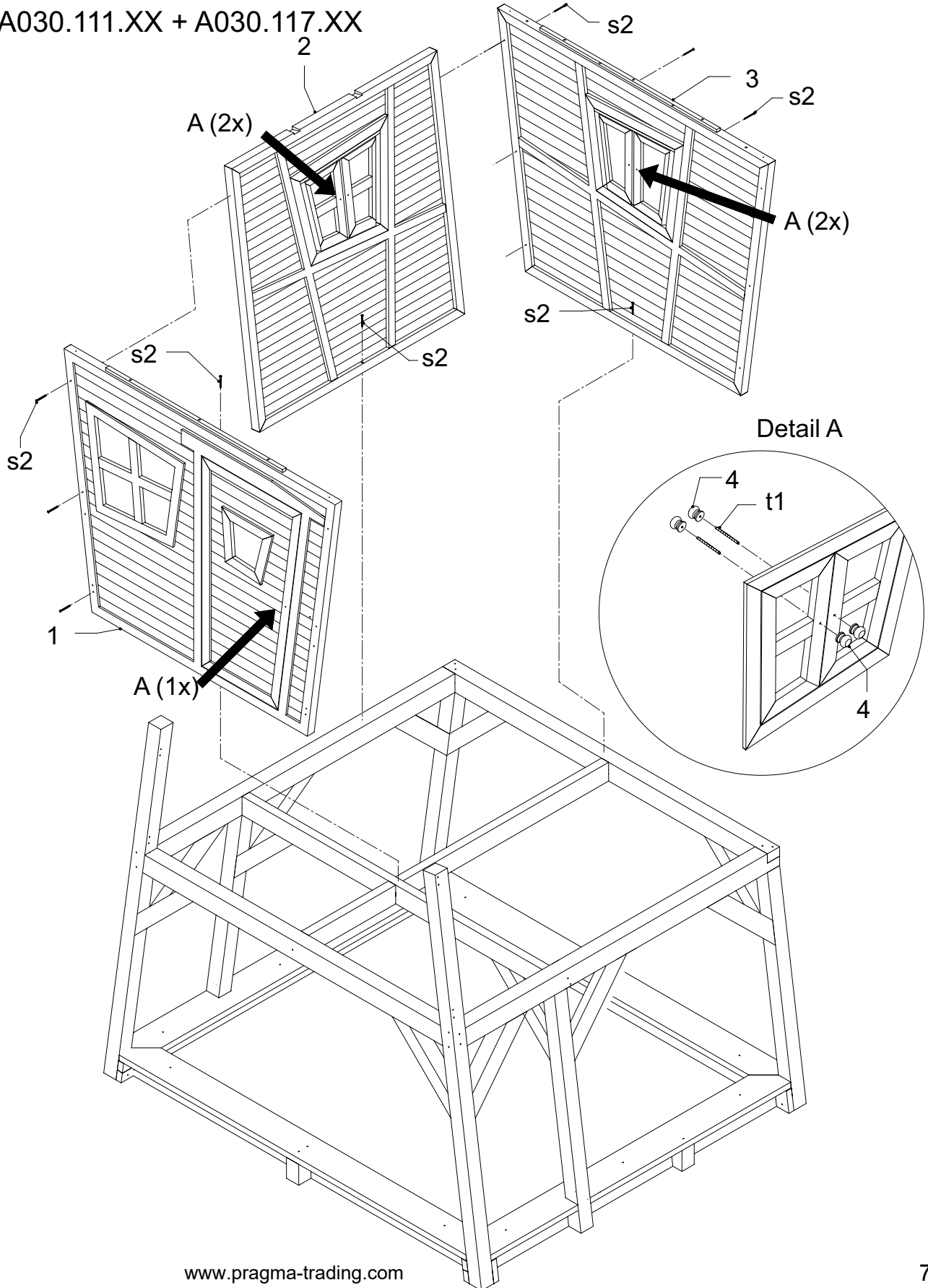



Max

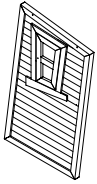

5

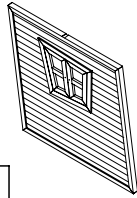

6

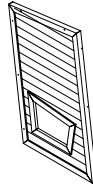

7



4

6x

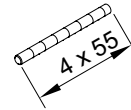

t1

3x

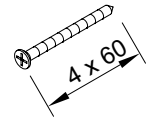

s2

6x

A030.117.XX + A030.118.XX

Detail A

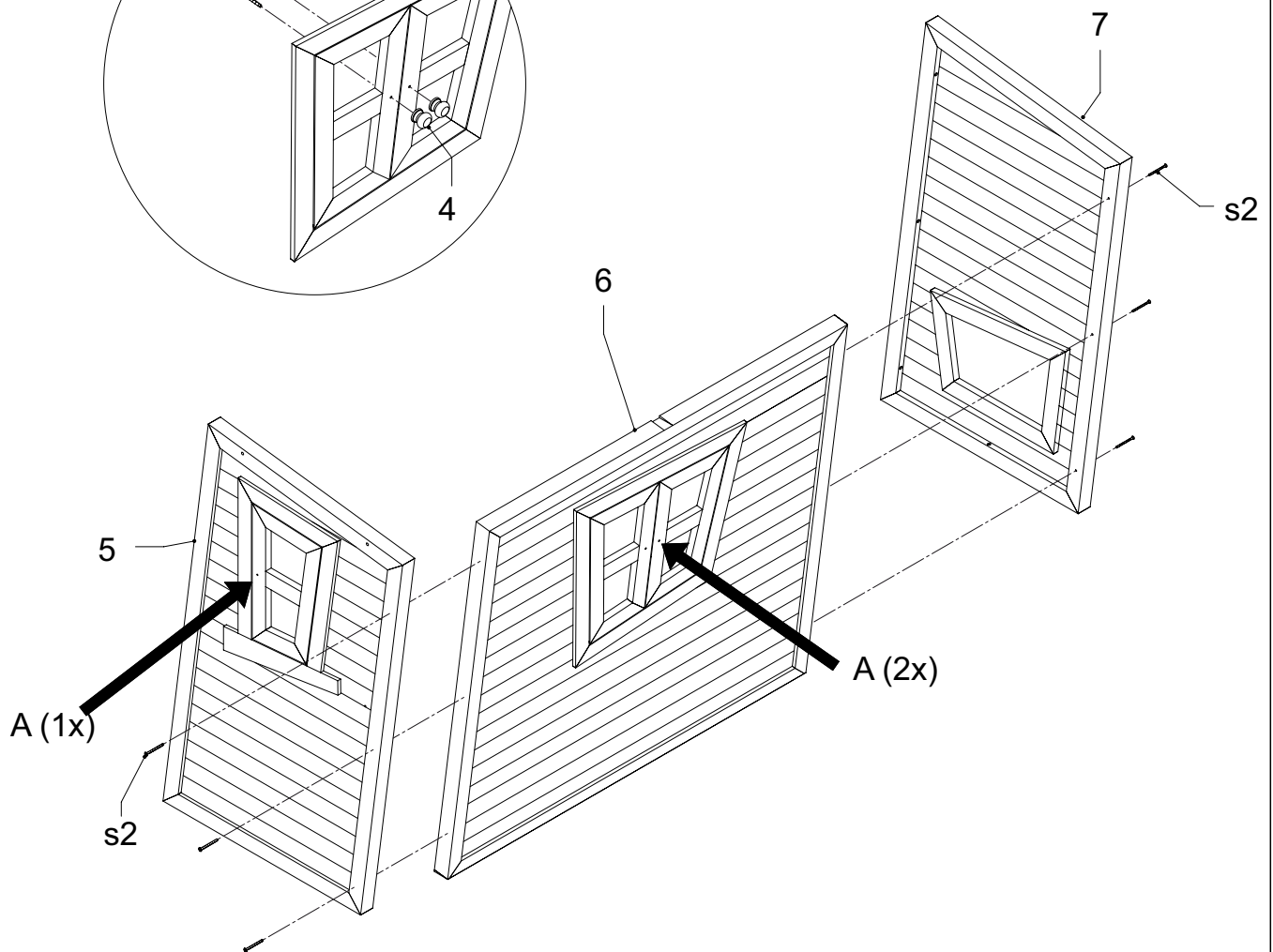
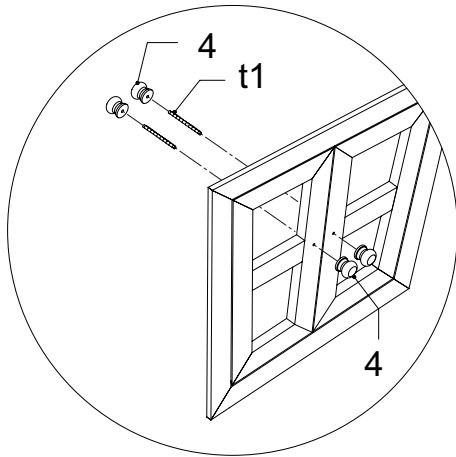

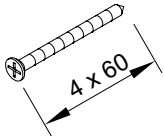

s2

9x

A030.118.XX

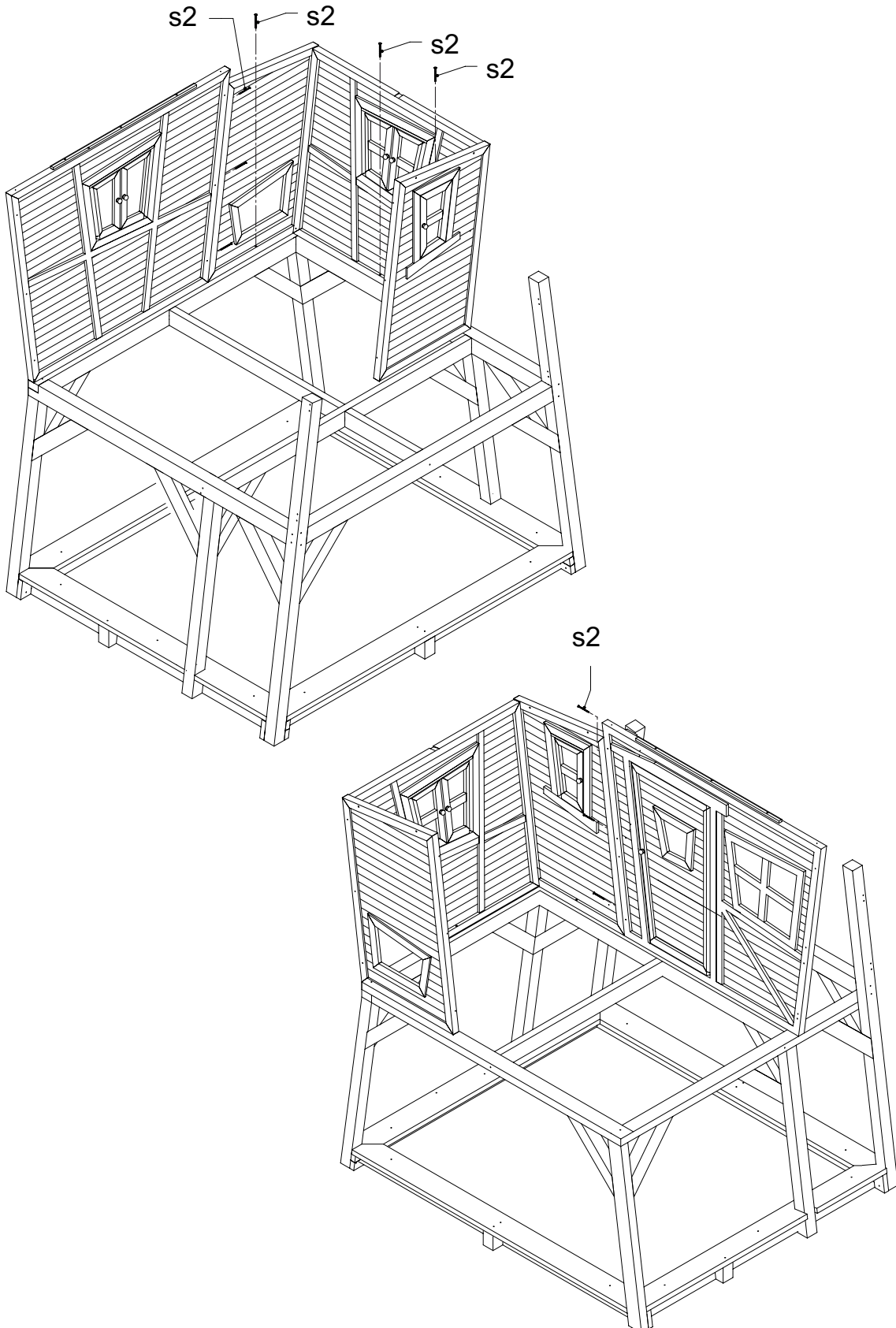



Max

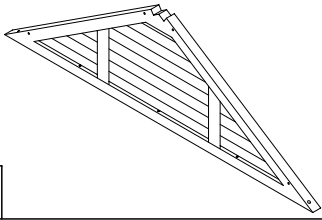

8

2x

s2

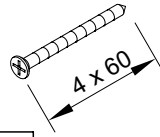

10x

A030.111.XX

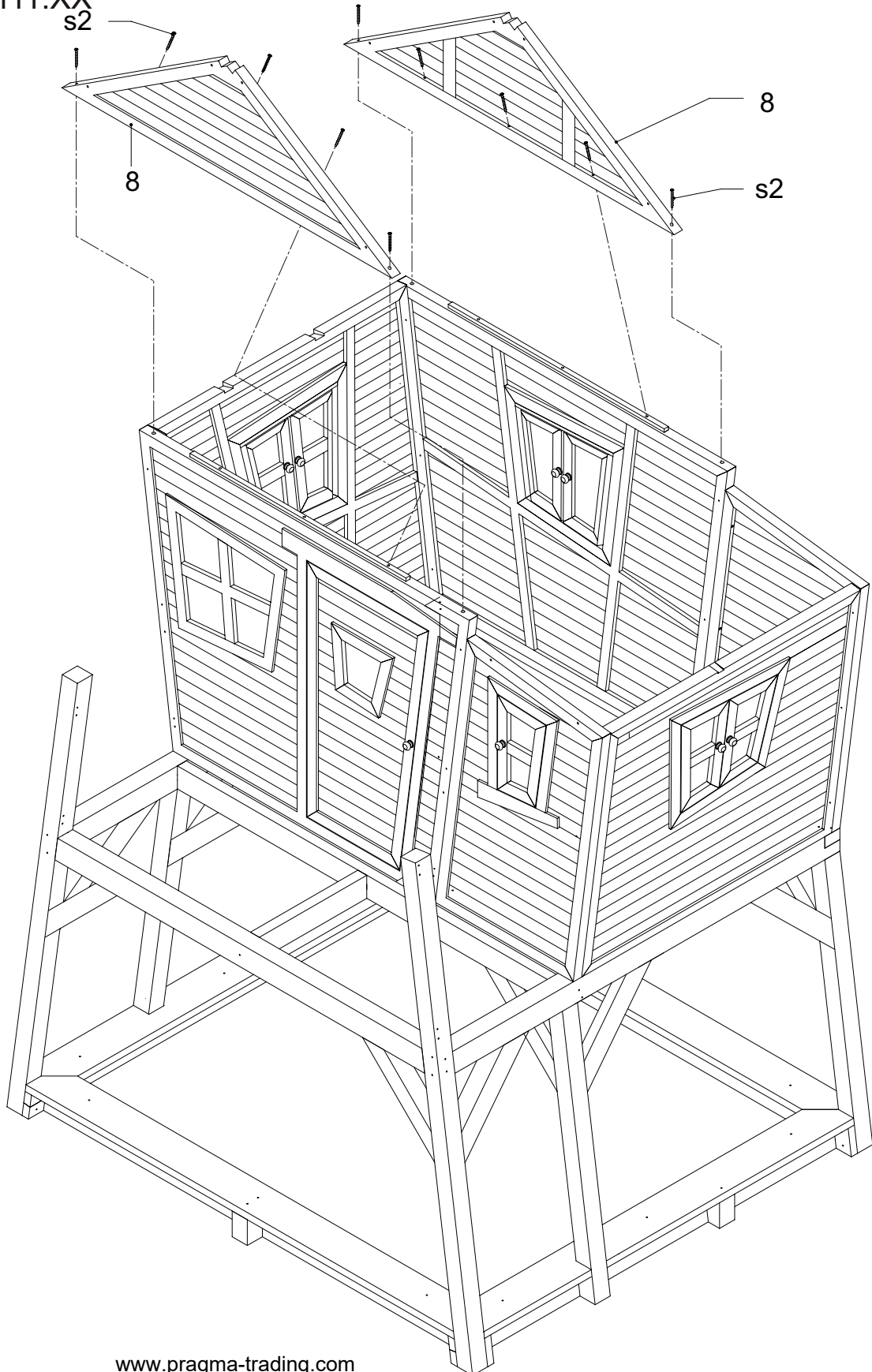



Max

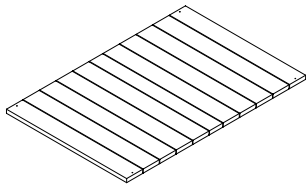

9

2x

s1

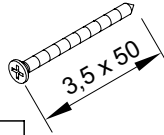

8x

A030.142.XX

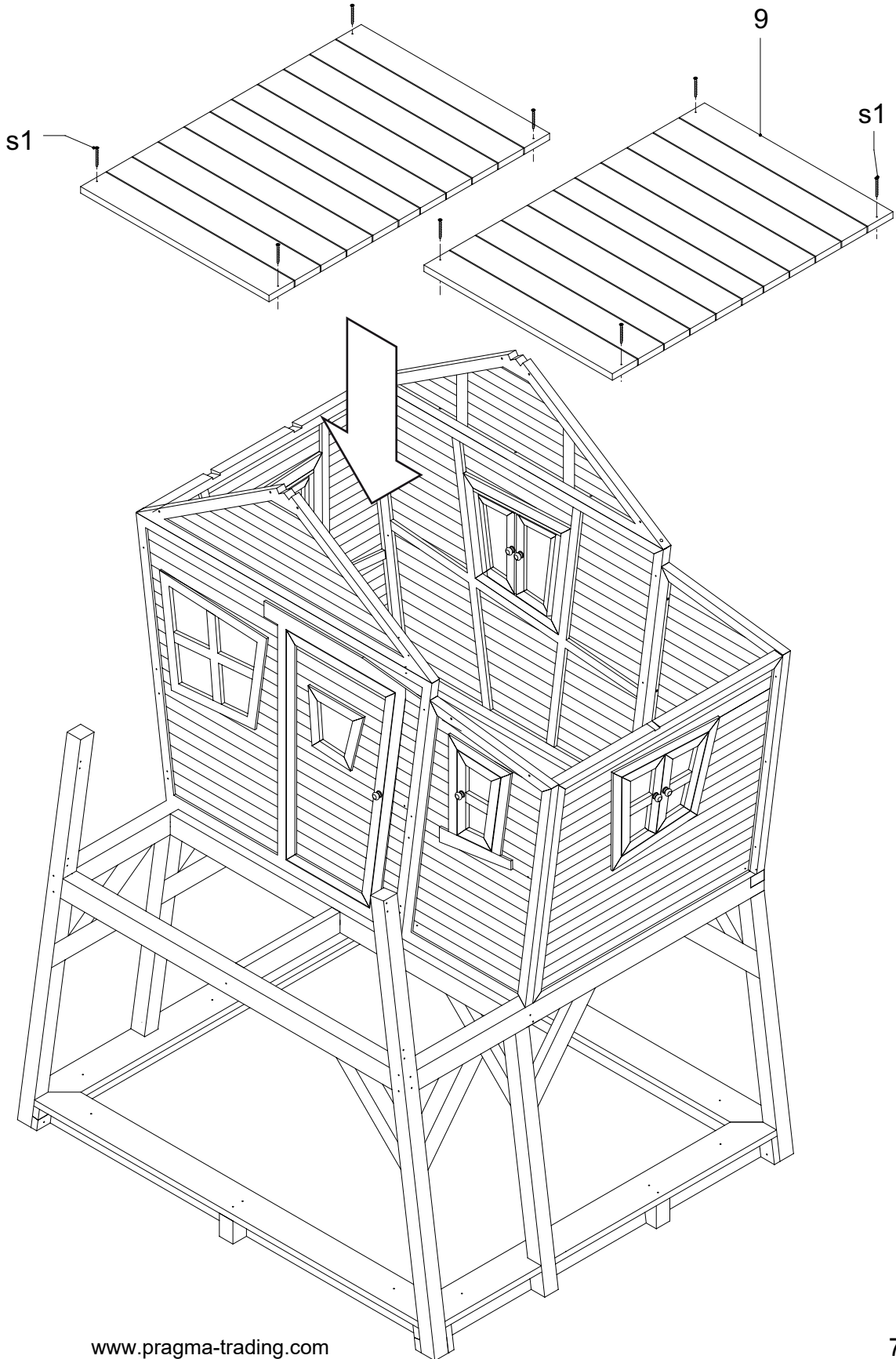

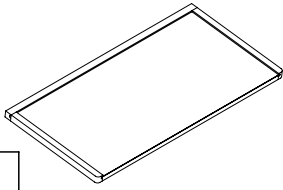

10

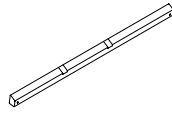

11

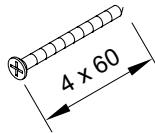

s2

6x

A030.118.XX

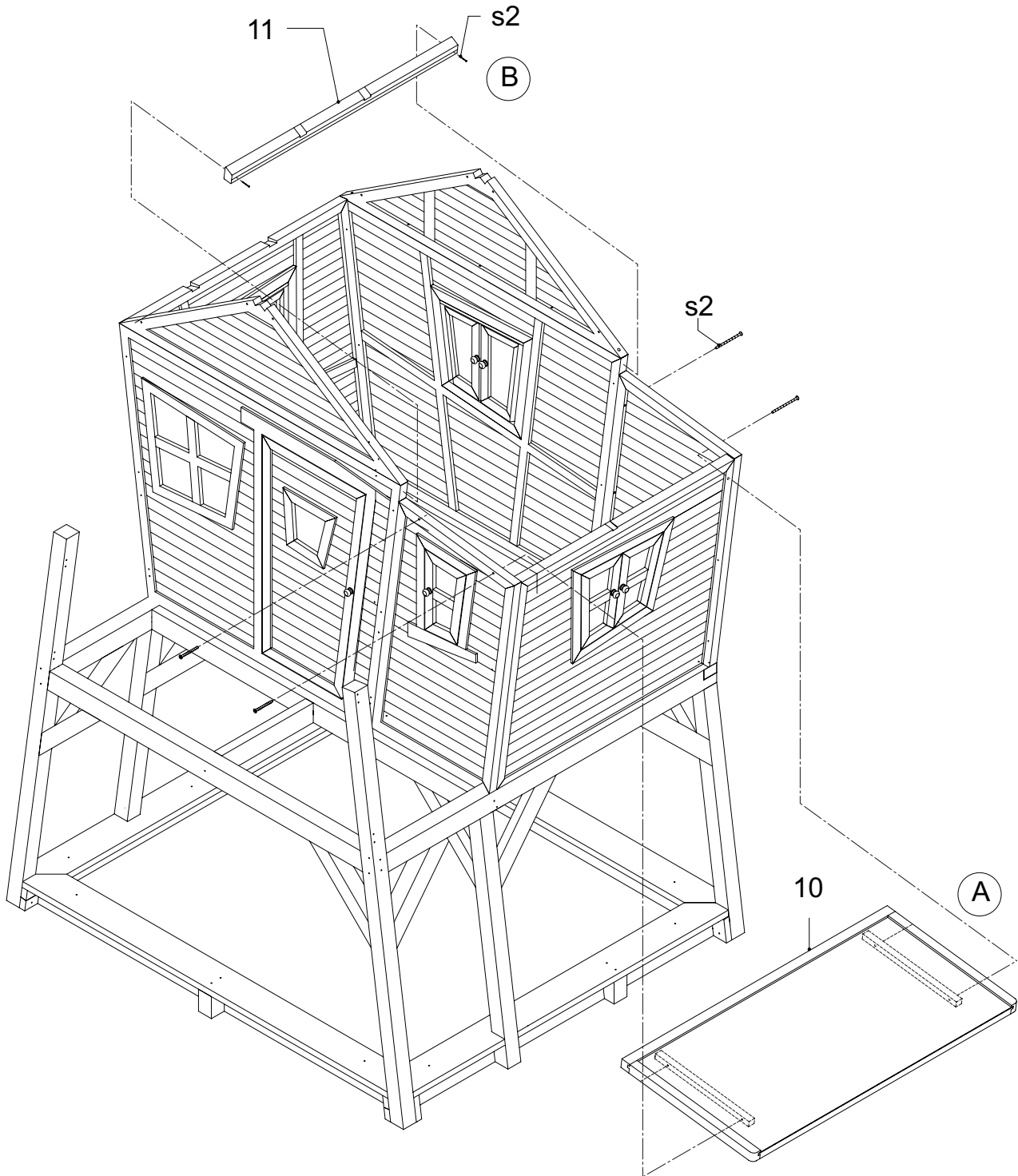



Max

12	13	14	15	16	16A	16B	17	s3 16x	s6 6x

A030.113.XX

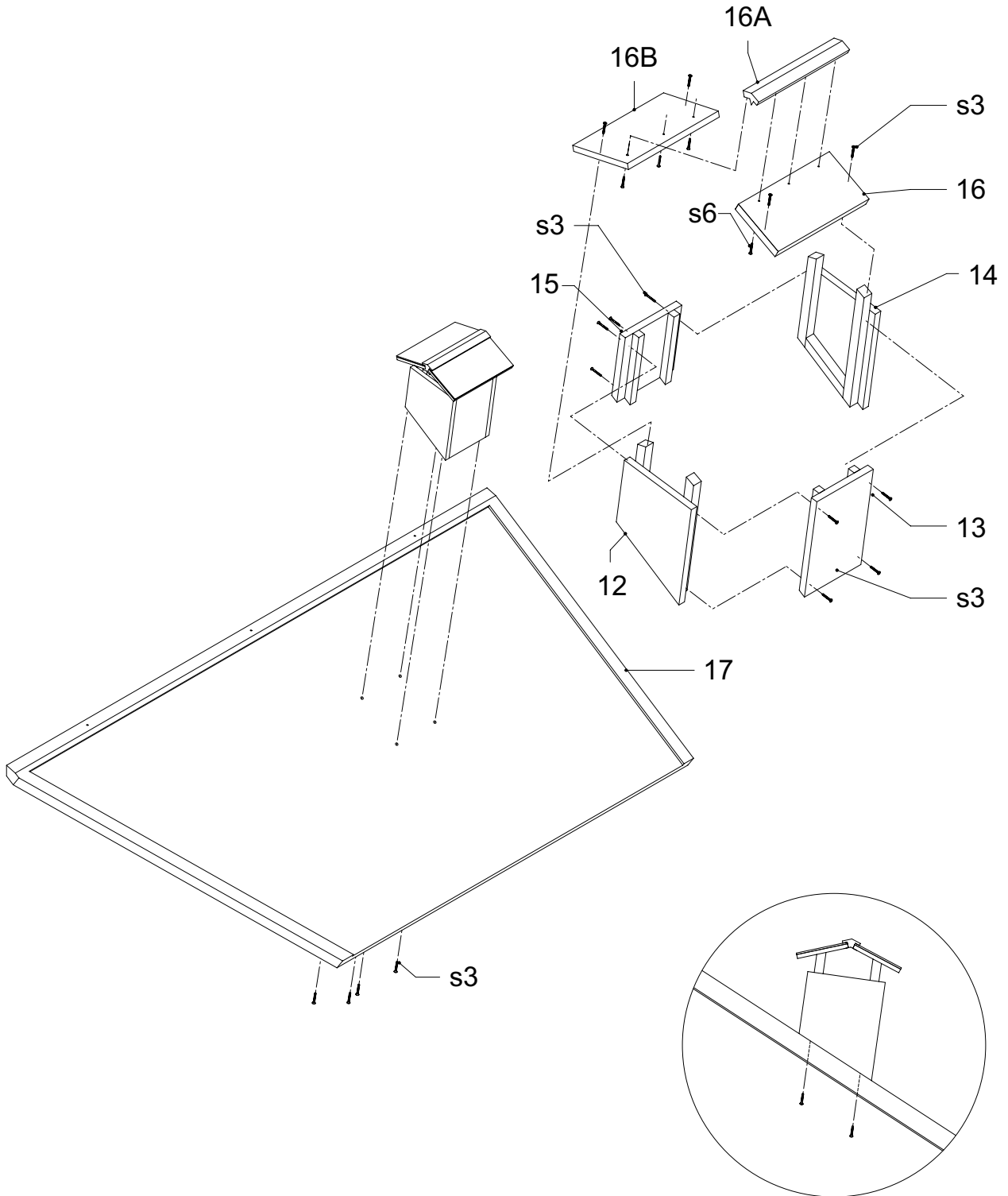



Max

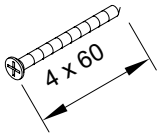

s2

4x

A030.113.XX

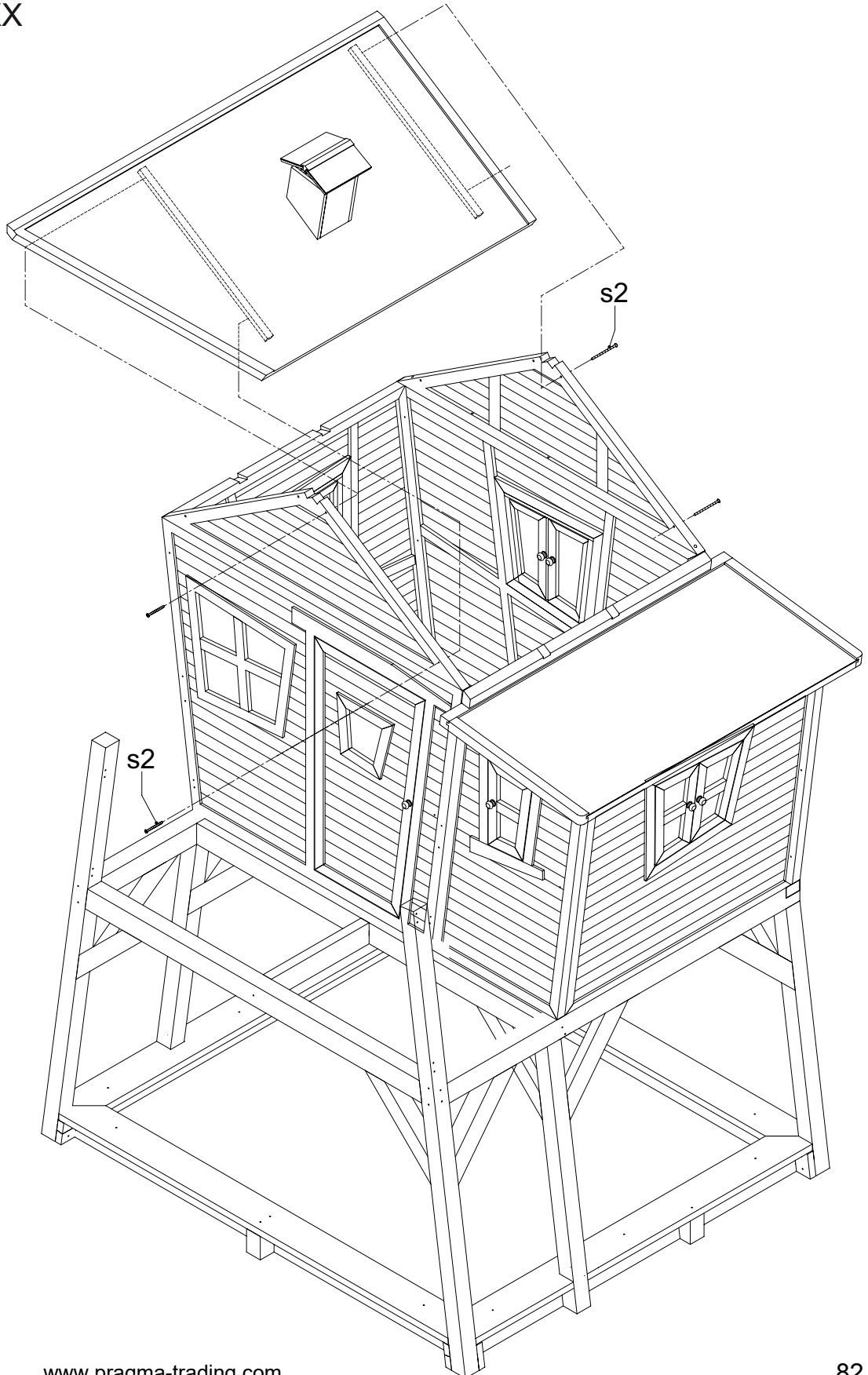

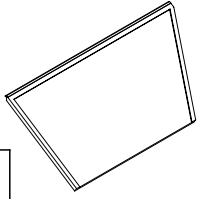

18

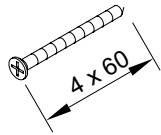

s2

4x

A030.113.XX

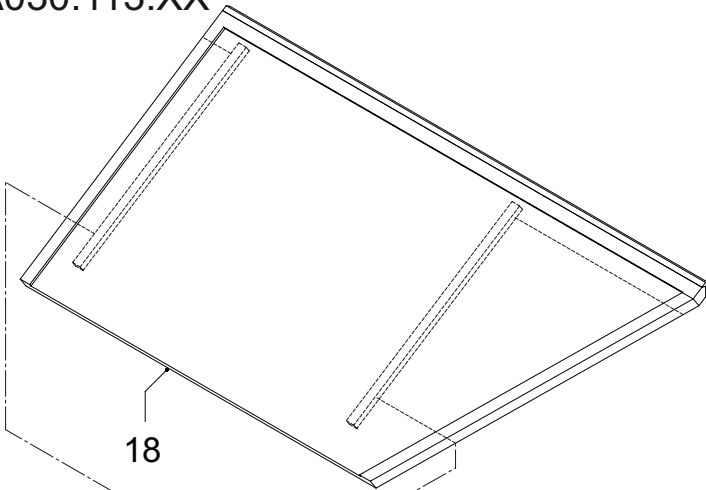

18

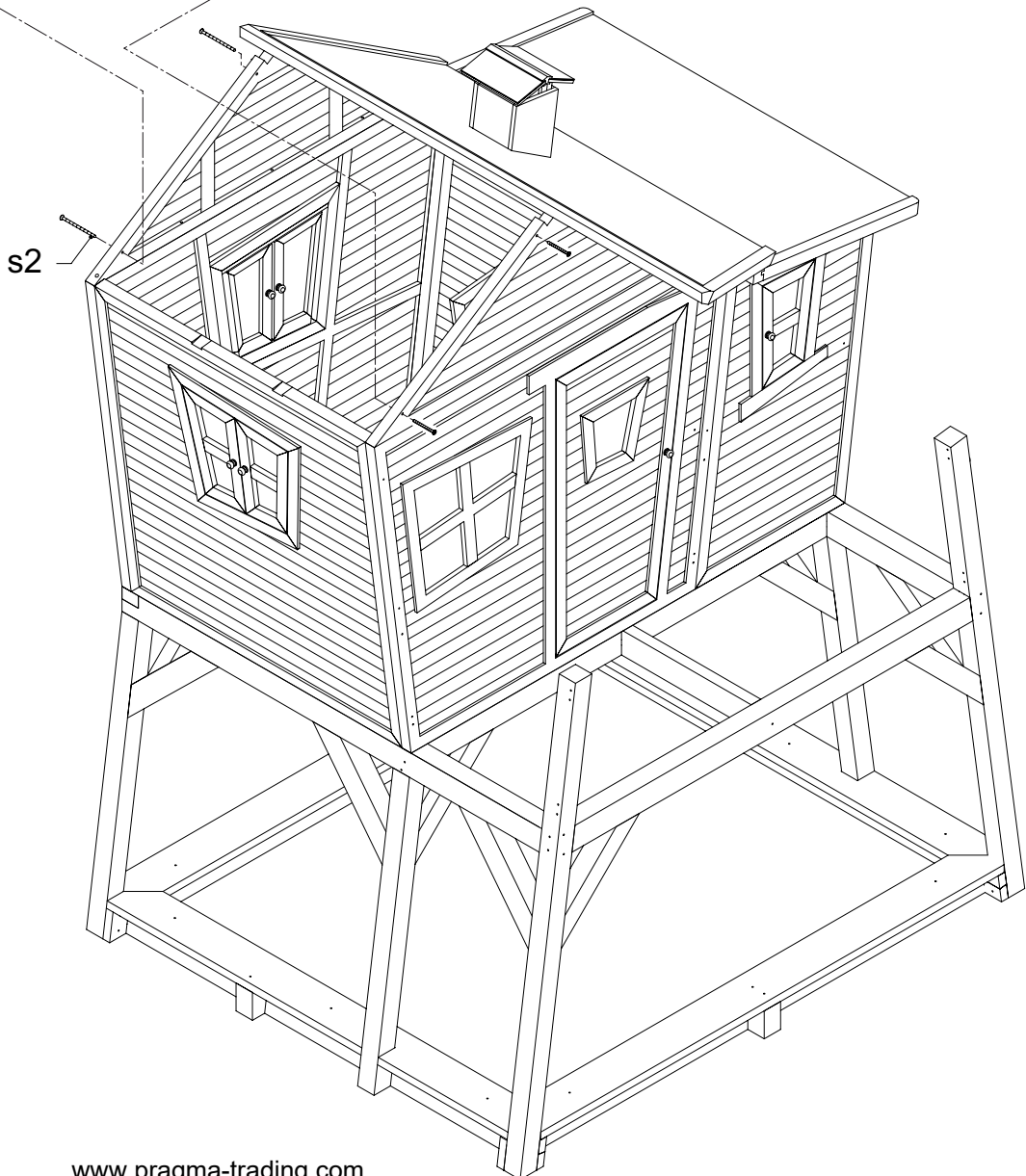

s2



19

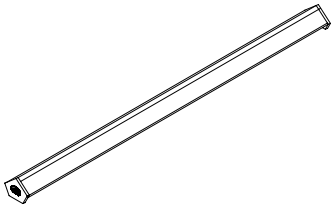

s4

15x

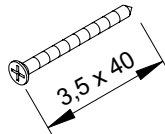

A030.113.XX

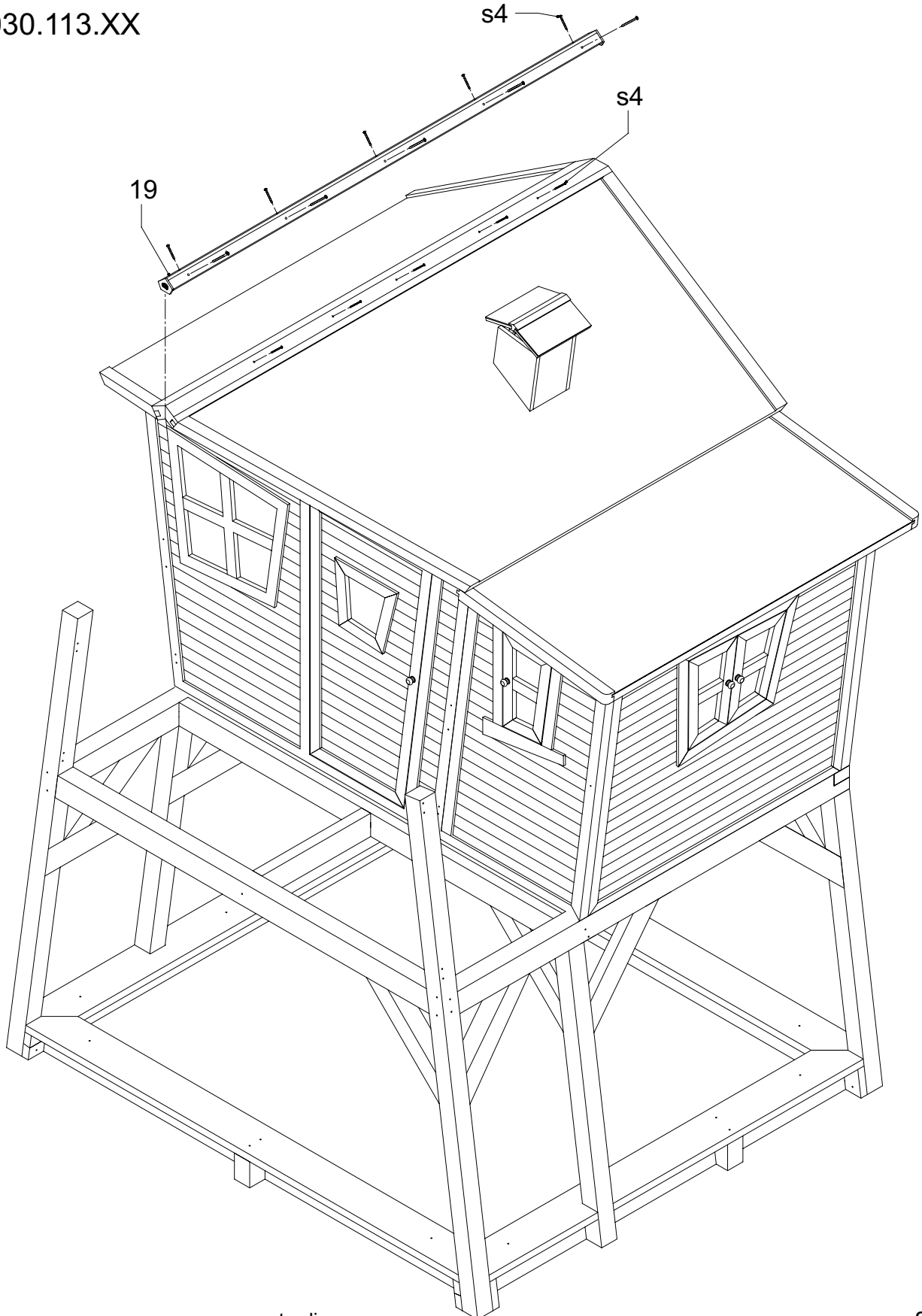



Max

38							
38A		39	40	41	s1 16x	s2 2x	s7 4x

A039.120.XX + A030.155.XX + A030.157.XX

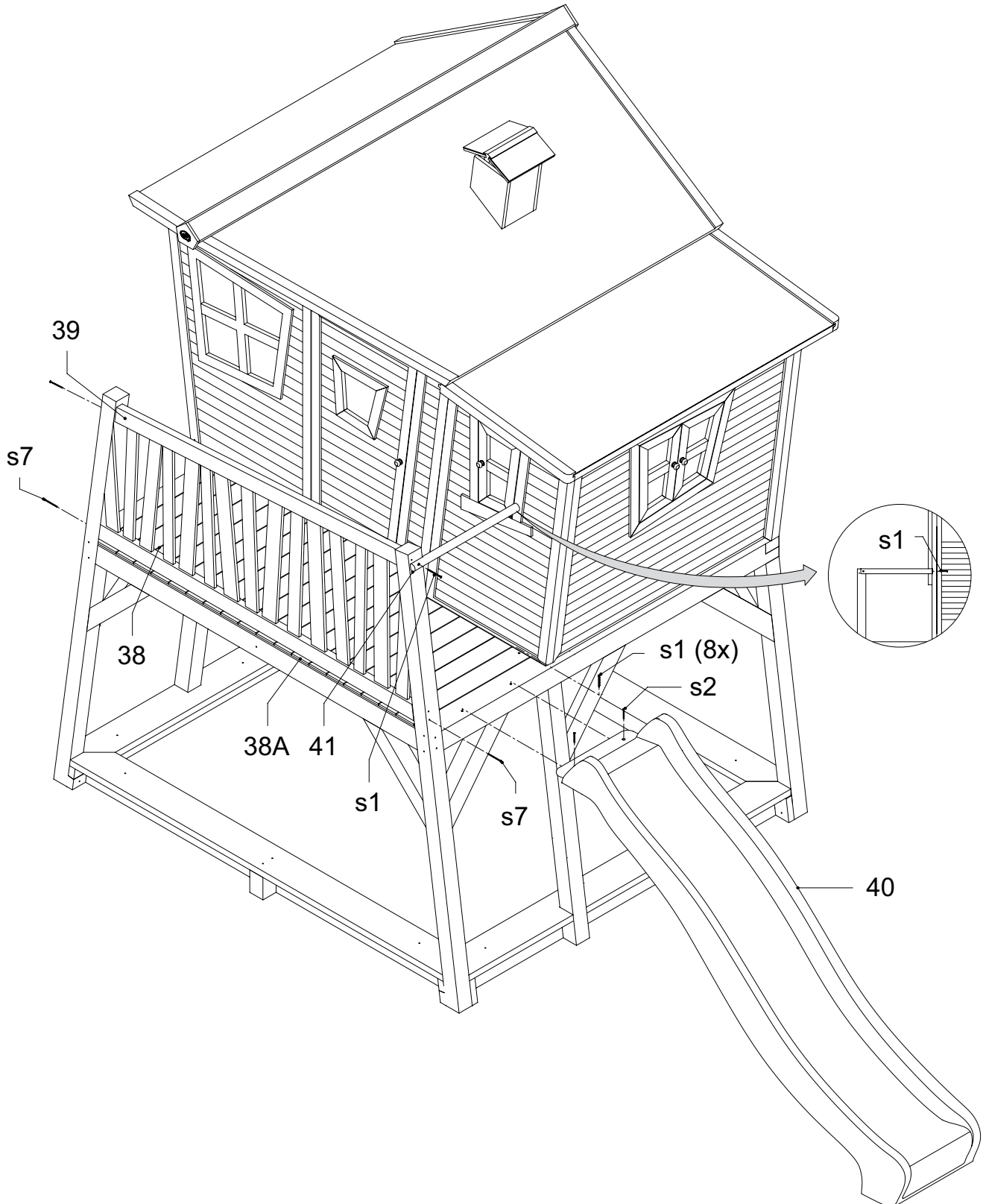



Max

42	3x	43	7x	44	45	s1	34x	s5	4x

A030.155.XX

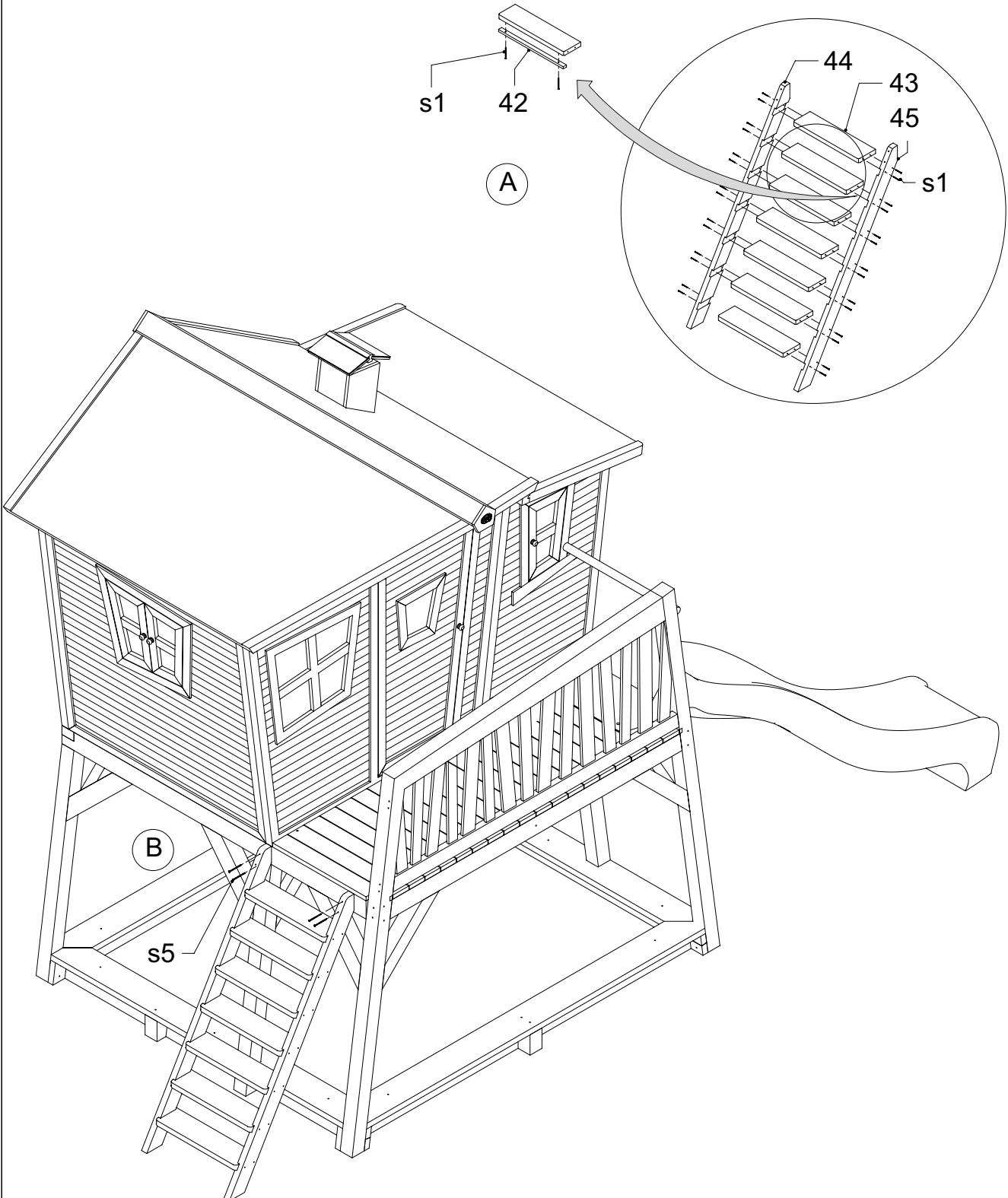

INTRODUCTION

Congratulations on your purchase of a AXI playhouse. In choosing this product, you have bought a product you will enjoy for many years.

1. SAFETY

This AXI playhouse is designed and manufactured according to European EN71 and CE standards, which guarantees the safety of the playhouse.

1.1 SAFETY INSTRUCTIONS

- Do not allow children to play without (parental) supervision.
- Climbing or playing on the roof of a AXI playhouse is not permitted.
- AXI playhouses are suitable for up to two children and one adult (maximum weight - 150 Kg.).

2. ASSEMBLY

- The assembly of the playhouse must only be done by an adult.
- It is strongly recommended that a AXI playhouse with a raised base framework should be anchored with an anchoring set (can be purchased separately). This increases the stability and therefore the safety of the playhouse.
- Do not place the AXI playhouse on a hard surface, such as concrete or asphalt. A fall from the playhouse onto a hard surface can cause serious injury. A shock-absorbent surface, for at least 1.50 meters around the AXI playhouse, like grass, wood chips or sand is required for playhouses higher than 60.0 cm.
- **WARNING:** Place the AXI playhouse on a flat surface and at least 2.00 meters away from other structures and other obstacles such as house walls, garage, fence, overhanging branches or clotheslines.
- Do not place the AXI playhouse on a surface that will remain damp. This can be achieved by using the anchoring set or for AXI playhouses without a raised base framework by placing a paving stone between each corner of the playhouse and the ground.
- For the AXI playhouses with a slide, it is recommended the house should be sited so that the slide does not face south. The temperature of the slide can be increased considerably simply by the heat of the sun.

3. MATERIAL

This AXI playhouse is made of Cedar wood with FSC quality mark. This wood has a natural resistance to wood rot and pests.

4. MAINTENANCE

- Check whether there are any sharp edges, replace part as necessary.
- It is necessary to check regularly for splinters, loose screws and the tightness of joints and/or fastenings. If necessary, nuts and bolts must be tightened. 'Regularly means: when you put it up and twice a month during the outdoor play season.
- Once a year check the state of the protective stain layer. To ensure the optimum durability, the AXI playhouse needs to be given a new coat of stain every two years. Use a water-based paint / stain based on natural components for this.
- **WARNING:** No maintenance can result in hazardous situations.

WARNING!

- A fall from a playhouse onto a hard surface can cause serious injury. AXI cannot be held responsible if this occurs. Always place the house on a soft surface.
- AXI playhouses are designed for private use. These playhouses must not be rented or placed in public places like schools and day-care nurseries. In the case of rental or use in public places, any guarantee or warranty becomes invalidate and other liabilities claims lapse.
- Wood is a natural product that is subject to the effect of the weather that may cause the wood to warp and split. No guarantee is provided for the consequences of weather conditions on the construction that do not cause any damage, such as splits in the wood and warping of the panels.

If the product does not reach you in good condition or if there are other problems, please contact your dealer or point of sale where you purchased the product.

5. GUARANTEE CERTIFICATE

AXI provides a 2-year guarantee on its AXI wooden playhouses when properly used in respect of the joints and accessories and a guarantee of 10 years on the wood.

AXI reserves the right not to provide a guarantee if:

- no original sales receipt can be presented;
- natural effects of weather conditions on the wood have caused warping and splitting of wood that do not have a negative impact on the construction of the AXI playhouse;
- the AXI playhouse is used for purposes other than those for which it was designed;
- a method of assembly is used other than the method indicated;
- technical repairs have been carried out unprofessionally;
- the AXI playhouse is used in public places like schools and day-care nurseries;
- the AXI playhouse is rented to third parties;
- the regular monitoring and where appropriate replacement of parts, screws and joints has been omitted.
- there is a failure to re-stain or paint the AXI playhouse once every two years.

EINLEITUNG

Herzlichen Glückwunsch zum Erwerb eines AXI Spielhauses. Mit Ihrer Entscheidung haben Sie ein Produkt erworben, an dem Sie viele Jahre lang Freude haben werden.

1. SICHERHEIT

Dieses AXI-Spielhaus wurde nach den Europäischen Normen EN71 und CE entwickelt und hergestellt, wodurch die Sicherheit des Spielhauses gewährleistet wird.

1.1 SICHERHEITSANWEISUNGEN

- Lassen Sie Kinder niemals ohne (elterliche) Aufsicht spielen.
- Auf das Dach des AXI Spielhauses darf nicht geklettert werden. Auf dem Dach darf nicht gespielt werden.
- AXI Spielhäuser eignen sich für maximal zwei Kinder und einen Erwachsenen (150 kg Gesamtgewicht).

2. INSTALLATION

- Die Montage des Spielhauses darf nur von erwachsenen Personen durchgeführt werden.
- Es wird deutlich darauf hingewiesen, dass ein AXI Spielhaus mit erhöhtem Rahmen mit einem Verankerungsset (gesondert zu erwerben) verankert werden sollte. Dies erhöht die Standfestigkeit und daher auch die Spielsicherheit.
- Stellen Sie das AXI Spielhaus nicht auf einem harten Untergrund wie Beton oder Asphalt auf. Das Herunterfallen vom Haus auf eine harte Oberfläche kann zu ernsthaften Verletzungen führen. Ein schockabsorbierender Boden, beispielsweise Gras, Holzschnitzel oder Sand ist bei AXI Spielhäusern mit einer Höhe über 60,0 cm verpflichtet. Dieser Boden muss rundherum bis 1,50 m vom Spielhaus vorhanden sein.
- Stellen Sie das AXI Spielhaus auf einem flachen Untergrund auf und halten Sie einen Abstand von mindestens 2 m zum nächsten Bau oder Hindernis, wie Haus, Garage, Zaun und überhängende Zweige oder Wäscheleinen, ein.
- Das AXI Spielhaus darf nicht auf nassem Untergrund aufgestellt werden. Verwenden Sie dazu das Verankerungsset oder für AXI Spielhäuser ohne erhöhten Rahmen Bodenfliesen zwischen dem Boden und den Ecken des Spielhauses.
- Bei den AXI Spielhäusern mit Rutsche ist es empfehlenswert, das Haus so aufzustellen, dass die Rutsche nicht nach Süden zeigt. Die Temperatur der Rutsche kann in direkter Sonneneinstrahlung stark zunehmen.

3. MATERIAL

AXI Spielhäuser sind hergestellt aus Zedernholz mit FSC-Prüfsiegel. Dieses Holz bietet natürlichen Schutz gegen Fäule und Ungeziefer.

4. WARTUNG

- Das Haus muss regelmäßig nach Splittern, Schrauben und Festigkeit der Verbindungen und/oder Befestigungen kontrolliert werden. Falls notwendig, müssen Schrauben und Muttern festgezogen werden. Mit regelmäßig ist gemeint: in der Draußenspielsaison mindestens zwei Mal pro Monat.
- Kontrollieren Sie jährlich den Zustand der Beizschicht. Für optimale Haltbarkeit muss das AXI Spielhaus einmal in zwei Jahren neu mit Beize behandelt werden. Verwenden Sie dazu eine wasserlösliche Farbe oder Beize auf natürlichem Basis.
- **ACHTUNG:** Wenn Sie Wartungsarbeiten durchführen, kann es zu gefährlichen Situationen führen.

ACHTUNG!

- Das Herunterfallen vom Haus auf eine harte Oberfläche kann zu ernsthaften Verletzungen führen. AXI kann in diesen Fällen nicht zur Verantwortung herangezogen werden. Stellen Sie das Haus immer auf einem weichen Untergrund auf.
- Die AXI Spielhäuser sind für den privaten Gebrauch vorgesehen. Sie dürfen nicht vermietet oder auf öffentlichen Plätzen wie Schulen und Kindertagesstätten verwendet werden. Bei Vermietung oder Verwendung auf öffentlichen Plätzen verfällt jede Garantie sowie weitere Verantwortlichkeit.
- Holz ist ein Naturprodukt und damit von Wetterveränderungen abhängig, es kann sich verziehen und es können Splitter entstehen. Auf die witterungsbedingten Folgen für die Konstruktion, die keinen Schaden verursachen, wie Risse im Holz und Verziehen der Balken, erstreckt sich die Gewährleistungspflicht nicht.

Wenn Sie das Produkt nicht in einwandfreiem Zustand erhalten oder wenn sich andere Probleme ergeben, wenden Sie sich dann an den Händler oder die Verkaufsstelle, wo Sie das Produkt erworben haben.

5. GARANTIEZERTIFIKAT

AXI gibt für die AXI Holzspielhäuser bei richtiger Verwendung eine Garantie von 2 Jahren auf die Verbindungen und das Zubehör sowie eine Garantie von 10 Jahren auf das Holz.

AXI behält sich das Recht vor, die Garantieerklärung in folgenden Fällen nicht einhalten zu müssen:

- Fehlen eines originalen Kaufbelegs.
- Natürliche Wettereinflüsse auf das Holz, die zu Verziehen und Splittern führen können und sich nicht negativ auf die Konstruktion des AXI Spielhauses auswirken.
- Verwendung zu anderen Zwecken, als denen, für die das AXI Spielhaus entwickelt wurde.
- Eine andere als die vorgeschriebene Montageart.
- Die nicht fachkundige Ausführung technischer Reparaturen.
- Verwendung des AXI Spielhauses auf öffentlichen Plätzen wie Schulen und Kindertagesstätten.
- Vermietung des AXI Spielhauses an Dritte.
- Ausbleiben der regelmäßigen Kontrolle und bei Bedarf des Austausche von Teilen, Schrauben und Verbindungen.
- Ausbleiben des einmal in zwei Jahren Beizens oder Anstreichens des AXI Spielhauses.

INLEIDING

Gefeliciteerd met uw aankoop van dit AXI speelhuisje. Met deze keuze heeft u een product gekocht waarvan u jarenlang plezier zult hebben.

1. VEILIGHEID

Dit AXI speelhuisje is ontworpen en geproduceerd conform de Europese EN71 en CE normeringen, waarmee de veiligheid van het speelhuisje wordt gegarandeerd.

1.1 VEILIGHEIDSINSTRUCTIES

- Laat kinderen niet zonder (ouderlijk) toezicht spelen.
- Het is niet toegestaan op het dak van het speelhuisje te klimmen of te spelen.
- De speelhuisjes zijn geschikt voor maximaal twee kinderen en een volwassene (maximaal 150 Kg.).

2. MONTAGE

- Het monteren van dit speelhuisje mag alleen door volwassenen worden uitgevoerd.
- Het nadrukkelijke advies is een AXI speelhuisje met verhoogd frame te verankeren met een (afzonderlijk aan te schaffen) verankeringsset. Dit verhoogt de standvastigheid en daarmee de speelveiligheid.
- Plaats het speelhuisje niet op een harde ondergrond, zoals beton en asfalt. Een val van het huisje op een hard oppervlak kan ernstig letsel veroorzaken. Een schokdempende ondergrond, minimaal 1.50 meter rondom het speelhuisje, van bijvoorbeeld gras, houtsnippers of zand is verplicht bij speelhuisjes hoger dan 60,0 cm.
- **WAARSCHUWING:** Plaats het speelhuisje op een vlakke ondergrond en minimaal 2.00 meter uit de buurt van andere bouwwerken en obstakels zoals een huis, garage, hek en overhangende takken of waslijnen.
- Het speelhuisje mag niet op een natte ondergrond geplaatst worden. Dit kan worden gerealiseerd door het toepassen van een verankeringsset of door het plaatsen van een stoeptegels tussen iedere hoek van het speelhuisje en de grond.
- Voor de AXI speelhuisjes met glijbaan wordt geadviseerd het huisje zodanig te plaatsen dat de glijbaan niet op het zuiden gericht is. De temperatuur van de glijbaan kan anders sterk stijgen door de hitte van de zon.

3. MATERIAAL

Dit AXI speelhuisje is gemaakt van Cederhout met FSC keurmerk. Deze houtsoort heeft een natuurlijke afweer tegen houtrot en ongedierte.

4. ONDERHOUD

- Doe dit bij aanvang van, en tweemaal per maand tijdens het buitenspeelseizoen: Controleer op splinters, schroeven, de sterkte van verbindingen en/of bevestigingen. Indien van toepassing dienen schroeven en moeren te worden aangedraaid. Smeer bewegende metalen onderdelen met olie. Vervang defecte onderdelen.
- Controleer jaarlijks de conditie van de beitslaag. Voor een optimale duurzaamheid is het noodzakelijk het speelhuisje eens per twee jaar te voorzien van een nieuwe beitslaag. Maak hierbij gebruik van een watergedragen verf/beits op natuurlijke basis.
- **WAARSCHUWING:** Het niet uitvoeren van onderhoud kan gevaarlijke situaties opleveren.

LET OP!

- Een val van een speelhuisje op een hard oppervlak kan ernstig letsel veroorzaken. Plaats het huisje altijd op een zachte ondergrond.
- De speelhuisjes zijn bestemd voor particulier gebruik. Het is niet toegestaan deze speelhuisjes te verhuren of te plaatsen op openbare plaatsen zoals scholen en kinderdagverblijven. Bij verhuur of gebruik op openbare plaatsen vervalt iedere garantie en vervallen andere aansprakelijkheden.
- Hout is een natuurlijk product en daarmee onderhevig aan weersinvloeden dat mogelijk kromtrekken en houtspijlt tot gevolg kan hebben. Op de gevolgen van weersinvloeden die de constructie geen schade toebrengen, zoals scheuren in het hout en kromtrekken van de panelen, wordt geen garantie verleend.

Mocht het product u niet in goede staat bereiken of als er zich andere problemen voordoen, neem dan contact op met uw dealer of verkooppunt waar u het product heeft aangeschaft.

5. GARANTIECERTIFICAAT

AXI verstrekt op haar AXI houten speelhuisjes bij juist gebruik een garantie van 2 jaar op de verbindingen en accessoires en een garantie van 10 jaar op het hout.

AXI behoudt het recht geen garantie te verlenen als er sprake is van:

- het ontbreken van een origineel aankoopbewijs;
- natuurlijke weersinvloeden op het hout die kromtrekking en houtspijlt tot gevolg hebben die geen negatieve invloed hebben op de constructie van het AXI speelhuisje;
- toepassing voor andere doeleinden dan waarvoor het AXI speelhuisje ontwikkeld is;
- een andere dan de voorgeschreven wijze van montage;
- het onvakkundig uitvoeren van technische reparaties;
- gebruik van het AXI speelhuisje op openbare plaatsen zoals scholen en kinderdagverblijven;
- verhuur van het AXI speelhuisje aan derden;
- het nalaten van de regelmatige controle op en waar nodig vervanging van onderdelen, schroeven en verbindingen.
- het nalaten van het eens per twee jaar opnieuw beitsen of verven van het AXI speelhuisje.

INTRODUCTION

Nous vous félicitons d'avoir acheté une maisonnette de jeu AXI. Vous avez opté pour un produit qui vous apportera du bonheur pendant des années.

1. SÉCURITÉ

Cette maison de jeu AXI est conçue et fabriquée selon les normes européennes EN71 et CE, ce qui garantit la sécurité de la maison de jeu.

1.1 CONSIGNES DE SÉCURITÉ

- Ne laissez pas jouer les enfants sans la surveillance d'un adulte.
- Il n'est pas autorisé de grimper sur le toit d'une maisonnette de jeu AXI ou de jouer sur le toit.
- Les maisonnettes de jeu AXI conviennent pour deux enfants et une personne adulte maximum (poids maximal 150 Kg.).

2. MONTAGE

- Le montage de la maisonnette de jeu doit être effectué par une personne adulte.
- Nous conseillons impérativement d'ancrer la maisonnette de jeu AXI sur un cadre plus élevé à l'aide d'un kit d'ancrage (non fourni). La stabilité et donc la sécurité de jeu seront ainsi mieux garanties.
- Ne posez pas la maisonnette de jeu AXI sur une surface dure, comme le béton et l'asphalte. Une chute de la maisonnette sur une telle surface dure peut causer des blessures graves. Une surface de pose amortissant s'étendant au moins à un diamètre de 1,50 m autour de la maisonnette de jeu AXI, comme du gazon, des copeaux de bois ou du sable est obligatoire pour les maisonnettes de jeu d'une hauteur supérieure à 60 cm.
- Posez la maisonnette de jeu AXI sur une surface plane et gardez une distance d'au moins 2 mètres des autres édifices et obstacles, comme les maisons, garages, barrières, branches et cordes à linge.
- Il n'est pas autorisé de poser la maisonnette de jeu AXI sur une surface humide. Cela est possible moyennant le kit d'ancrage ou, pour les maisonnettes de jeu AXI sans cadre surélevé, en insérant une dalle de trottoir entre les angles de la maisonnette et le sous-sol.
- Les maisonnettes de jeu AXI avec toboggan devraient être orientées de sorte que le toboggan ne soit pas dirigé vers le sud. La température du toboggan risquerait d'augmenter par la chaleur du soleil.

3. MATÉRIAU

Les maisonnettes de jeu AXI sont fabriquées en Bois de cèdre avec le label FSC. Cette espèce de bois présente une défense naturellement contre la pourriture du bois et la vermine.

4. ENTRETIEN

- Il est impératif de contrôler régulièrement s'il y a des éclats de bois qui se détachent, si les vis sont bien serrées et si les raccords et/ou fixations sont en place et solides. Si nécessaire, serrez les vis et écrous. Périodiquement signifie, dans ce cas : au début de la saison de jeux à l'extérieur, puis deux fois par mois pendant la saison.
- Annuellement pour la couche de teinture. Afin d'assurer une durabilité optimale, la maisonnette de jeu AXI doit être traitée tous les deux ans. Appliquez une peinture/teinture naturelle à base d'eau.
- ATTENTION: Ne pas effectuer la maintenance peut entraîner des situations dangereuses.

ATTENTION !

- Une chute de la maisonnette sur une surface dure peut causer des blessures graves. AXI décline toute responsabilité pour les éventuelles chutes. Posez toujours la maisonnette sur une surface molle.
- Les maisonnettes de jeu AXI sont destinées à une utilisation privée. Il n'est pas autorisé de louer ces maisonnettes ou de les poser sur une place publique comme des écoles et garderies d'enfants. La garantie est annulée si la maisonnette de jeu est louée ou utilisée sur une place publique, ainsi que toute autre responsabilité.
- Le bois est un produit naturel, et comme tel, il est soumis aux influences météorologiques provoquant éventuellement des déformations ou fissures. Nous n'octroyons aucune garantie pour les effets des intempéries sans conséquence pour la construction, comme des déchirures du bois ou des déformations des panneaux.

Veillez contacter votre revendeur ou le point de vente où vous avez acheté la maisonnette de jeu si le produit n'est pas livré en bon état ou si vous constatez un autre problème.

5. CERTIFICAT DE GARANTIE

AXI donne une garantie de 2 ans sur raccords et accessoires de ses maisonnettes de jeu en bois AXI et une garantie de 10 ans sur le matériau bois, à condition d'une utilisation conforme de la maisonnette.

AXI se réserve le droit de refuser la garantie sous les conditions suivantes :

- manque d'un justificatif d'achat original ;
- effet naturel des intempéries provoquant des déformations et fissures du bois sans conséquence sur la construction de la maisonnette de jeu AXI ;
- application à des fins autres que celles précisées pour la maisonnette de jeu AXI ;
- montage autre que celui préconisé ;
- exécution incompétente des réparations techniques ;
- utilisation de la maisonnette de jeu AXI sur des places publiques, comme des écoles et garderies d'enfants ;
- location de la maisonnette de jeu AXI à un tiers ;
- manque de contrôle régulier et, au besoin, remplacement des composants, vis et raccords.
- omission de teinter ou repeindre la maisonnette de jeu AXI.

INTRODUCCIÓN

Felicidades por la compra de su casita de juguete AXI. Al elegir nuestra marca, usted disfrutará muchos años de un producto de calidad.

1. SEGURIDAD

Las casitas de juguete AXI está diseñada y fabricada de acuerdo con las normas europeas EN71 y CE, lo que garantiza la seguridad de la casa de juegos.

1.1 INSTRUCCIONES DE SEGURIDAD

- No deje que los niños jueguen solos sin supervisión (de los padres).
- No está permitido subirse al techo de una casita de juguete AXI ni jugar sobre él.
- Las casitas de juguete AXI son aptas, como máximo, para dos niños y un adulto (máximo 150 kg).

2. MONTAJE

- El montaje de la casita tan solo debe ser realizado por personas adultas.
- Se recomienda explícitamente anclar la casita de juguete AXI con un marco elevado con un set de fijación (de compra adicional). Este set aumentará la firmeza y, con ello, la seguridad en el juego.
- No coloque la casita de juguete AXI sobre una superficie dura, como hormigón o asfalto. Si una persona se cae de la casita sobre una superficie dura, podría sufrir graves lesiones. Las casitas de juguete AXI con una altura mayor de 60,0 cm deben estar rodeadas de una superficie de un mínimo de 1,5 metros que amortigüe los golpes, por ejemplo, de césped, trizas de madera o arena.
- Coloque la casita de juguete AXI sobre una superficie plana y a una distancia mínima de 2 metros de otros edificios u obstáculos, como por ejemplo casas, garajes, vallas y ramas inclinadas o tendedores.
- La casita de juguete AXI no debe colocarse sobre una superficie húmeda. Las casitas de juguete AXI se colocan mediante el set de fijación y las que no tienen marco elevado, con una losa de acera entre cada esquina de la casita y el suelo.
- Las casitas de juguete AXI con tobogán se recomienda colocarlas de manera que el tobogán no esté orientado hacia el sur, ya que su temperatura podría aumentar considerablemente por el calor del sol.

3. MATERIAL

Las casitas de juguete AXI están fabricadas de Madera de cedro con marca de calidad FSC. Este tipo de madera tiene una resistencia natural contra la putrefacción y los bichos.

4. MANTENIMIENTO

- Es obligatorio comprobar de manera regular si hay astillas o tornillos que sobresalen, así como la resistencia de las uniones y/o fijaciones. Si es necesario, deberá apretar más fuerte los tornillos o pernos. Por "regularmente" se entiende: al comienzo de la temporada de juegos al aire libre y, dos veces al mes durante la misma.
- Compruebe una vez al año el estado de la capa de nogalina. Para una durabilidad óptima es necesario aplicar dos veces al año una nueva capa de nogalina a la casita de juguete AXI. Utilice una pintura o nogalina de base acuosa.
- ADVERTENCIA: El no llevar a cabo el mantenimiento puede dar lugar a situaciones peligrosas.

¡ATENCIÓN!

- Si una persona se cae de la casita de juguete sobre una superficie dura, podría sufrir graves lesiones. En este caso, no se podrá hacer responsable a AXI. COM Coloque siempre la casita sobre una superficie blanda.
- Las casitas de juguete AXI están destinadas para uso particular. No está autorizado alquilar o colocarlas en lugares públicos, como escuelas o guarderías. Si se alquilan o se usan en lugares públicos, quedarán anuladas todas las garantías y otras responsabilidades.
- La madera es un producto natural y está sometida a las inclemencias del tiempo. Por ello, podría arquearse o agrietarse. No se ofrece garantía por los efectos provocados por las inclemencias del tiempo que no dañen la construcción, como por ejemplo grietas en la madera y arqueamiento de los paneles.

Si no recibe el producto en buen estado o si se producen otros problemas, póngase en contacto con su distribuidor o punto de venta donde lo adquirió.

5. CERTIFICADO DE GARANTÍA

AXI ofrece una garantía de 2 años a las conexiones y accesorios de las casitas de juguete AXI, siempre que se utilicen de forma adecuada, y una garantía de 10 años a la madera.

AXI se reserva el derecho de no ofrecer garantía alguna en caso de:

- no presentar el recibo de compra original;
- inclemencias naturales del tiempo que arqueen o agrieten la madera que no alteren negativamente la construcción de la casita de juguete AXI;
- destinar la casita de juguete AXI con otros fines distintos de los que fue diseñada;
- un modo de montaje distinto del prescrito;
- reparaciones técnicas realizadas por personal no autorizado;
- usar la casita de juguete AXI en lugares públicos, como escuelas y guarderías;
- alquilar la casita de juguete AXI a terceros;
- no realizar el control regular y no sustituir partes, tornillos y conexiones si fuera necesario.
- no aplicar nogalina o pintar la casita de juguete AXI una vez cada dos años.

INTRODUZIONE

Congratulazioni per l'acquisto di questa casetta AXI. Con l'acquisto dei nostri prodotti avete scelto una qualità che dura nel tempo.

1. AVVERTENZE RELATIVE ALLA SICUREZZA

Questa casetta AXI è progettata e costruita secondo gli standard europei EN71 e CE, che garantisce la sicurezza del teatro.

1.1 NORME PER UN UTILIZZO SICURO DEL PRODOTTO

- Non lasciare mai svolgere ai bambini attività di gioco senza adeguata supervisione (altresì dei genitori).
- È vietato svolgere attività ludiche, arrampicarsi o sostare sul tetto della casetta AXI.
- Le casette AXI possono essere utilizzate da un numero massimo di 2 bambini e di 1 adulto (portata massima ammessa: 150 kg).

2. ISTRUZIONI PER IL MONTAGGIO

- Il montaggio della casetta deve avvenire esclusivamente da parte di soggetti adulti.
- Le casette AXI dotate di struttura rialzata devono essere obbligatoriamente ancorate al terreno mediante un apposito set di ancoraggio (da acquistare separatamente). Ciò consente di garantire la massima stabilità e sicurezza durante il gioco.
- Non posizionare la casetta AXI su superfici dure quali cemento o asfalto, poiché una eventuale caduta dalla casetta potrebbe comportare l'insorgenza di gravi lesioni. In caso di casette dotate di un'altezza maggiore rispetto a 60,0 cm è obbligatoria la posa di un piano di calpestio in materiale morbido (per es., in erba, trucioli di legno o sabbia) all'interno di un raggio perimetrale pari ad almeno 1,50 metri dalla casetta AXI.
- Posizionare la casetta AXI su una superficie piana e a una distanza minima di 2,00 metri da altre costruzioni edili e ostacoli (quali, ad esempio, fabbricati, garage, recinzioni, alberi con rami spioventi o corde per il bucato).
- È vietato collocare la casetta AXI su superfici umide o bagnate. A tale scopo è necessario utilizzare un set di ancoraggio oppure, qualora la casetta AXI non sia dotata di struttura rialzata, inserendo una lastra di pavimentazione tra ciascun angolo della casetta e il piano del terreno.
- È consigliabile eseguire l'assemblaggio delle casette AXI provviste di scivolo in modo tale da non posizionare lo scivolo orientato verso sud. Ciò per evitare un surriscaldamento della temperatura della superficie dello scivolo a causa dell'azione dei raggi solari.

3. MATERIALE COSTITUTIVO

Le casette AXI sono realizzate in Legno di cedro con marchio di qualità FSC. Questo tipo di materiale ligneo è dotato di una protezione naturale contro l'immarcescimento e parassiti.

4. MANUTENZIONE

- È obbligatorio verificare a intervalli regolari l'eventuale presenza di schegge nonché il serraggio delle viti, dei giunti e/o degli elementi di fissaggio. Se necessario, provvedere al giusto serraggio delle viti e dei dadi. Con "intervalli regolari" si intende all'inizio della messa in opera e due volte al mese durante l'uso regolare dell'attrezzo ludico.
- Verificare ogni anno le condizioni dello strato di vernice protettiva. Per una durata ottimale dell'attrezzo, è necessario provvedere una volta ogni 2 anni alla verniciatura della casetta AXI. Utilizzare a tale scopo una vernice a base di acqua / un colorante in soluzione acquosa a base naturale.
- ATTENZIONE: la mancata esecuzione della manutenzione può causare situazioni di pericolo.

ATTENZIONE

- Le eventuali cadute dalla casetta potrebbero comportare l'insorgenza di gravi lesioni. AXI declina qualsiasi responsabilità in tal senso. Posizionare la casetta su un piano di calpestio morbido.
- Le casette AXI sono destinate a un impiego in spazi privati. È vietato locare le casette o collocarle in spazi pubblici quali scuole e asili. La validità di qualsiasi garanzia o responsabilità decade in caso di locazione o di impiego del prodotto in spazi pubblici.
- Il legno è un prodotto naturale ed è, in quanto tale, soggetto a influssi atmosferici che potrebbero provocare inarcamenti e fessurazioni. La garanzia esclude espressamente gli effetti sortiti da agenti atmosferici - quali inarcamenti dei pannelli e fessurazioni del legno - che non provocano danni alla struttura.

Qualora il prodotto non risulti conforme alle specifiche all'atto della consegna o in caso di altri inconvenienti, contattare il rivenditore o il punto vendita presso cui è avvenuto l'acquisto.

5. CERTIFICATO DI GARANZIA

Le casette AXI in legno sono coperte da una garanzia AXI di 2 anni sui giunti e gli accessori e di 10 anni sui materiali lignei.

AXI si riserva il diritto di prestazione della garanzia qualora si verifichino i seguenti casi:

- mancanza dello scontrino o della prova di acquisto originale;
- effetti sortiti sul legno da agenti atmosferici naturali da cui derivino inarcamenti e fessurazioni e che non pregiudicano la struttura della casetta AXI;
- impiego della casetta AXI per scopi non conformi a quelli per i quali essa è progettata;
- assemblaggio eseguito secondo modalità diverse da quelle prescritte;
- inadeguata esecuzione di riparazioni tecniche;
- utilizzo della casetta AXI in spazi pubblici quali scuole e asili;
- locazione a terzi della casetta AXI;
- mancata esecuzione delle regolari verifiche ai componenti, alla bulloneria e agli elementi di fissaggio e loro eventuale sostituzione;
- mancata esecuzione delle operazioni di riverniciatura della casetta AXI una volta ogni 2 anni.



A Pragma Brand

AXI is one of our brands with awesome products of great quality, that offers hours of active fun!

Pragma / AXI

Kruisboog 40
3905 TG Veenendaal
Netherlands
T: +31 (0)318 - 57 88 00
info@pragma-trading.com
www.pragma-trading.com