

1

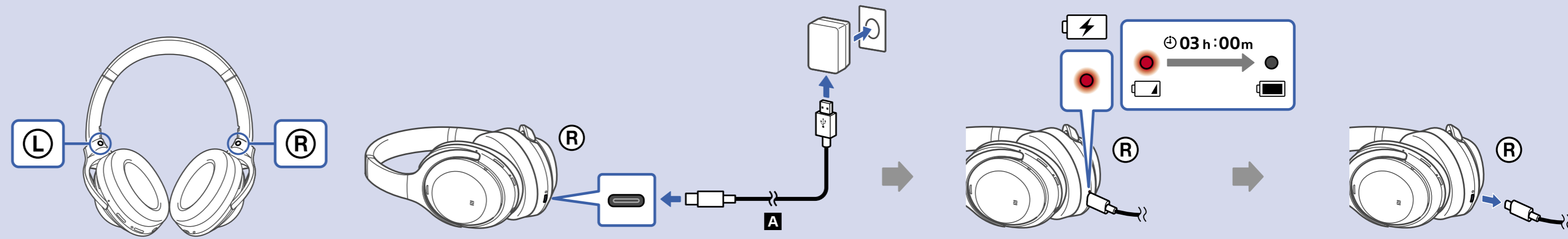

2

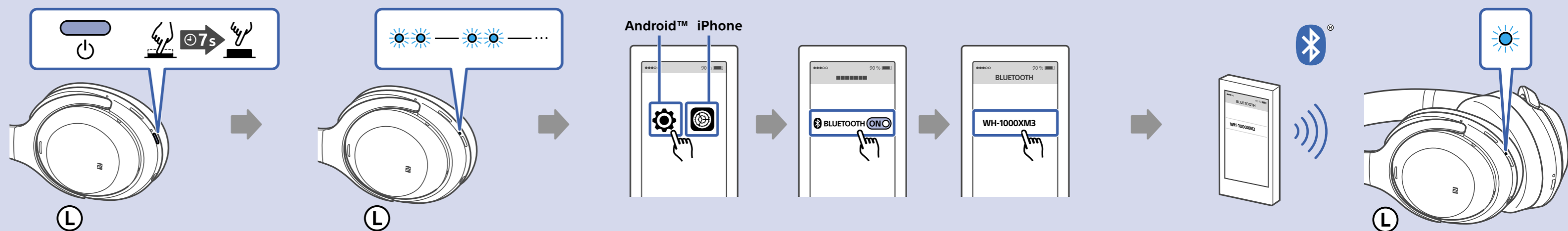

3

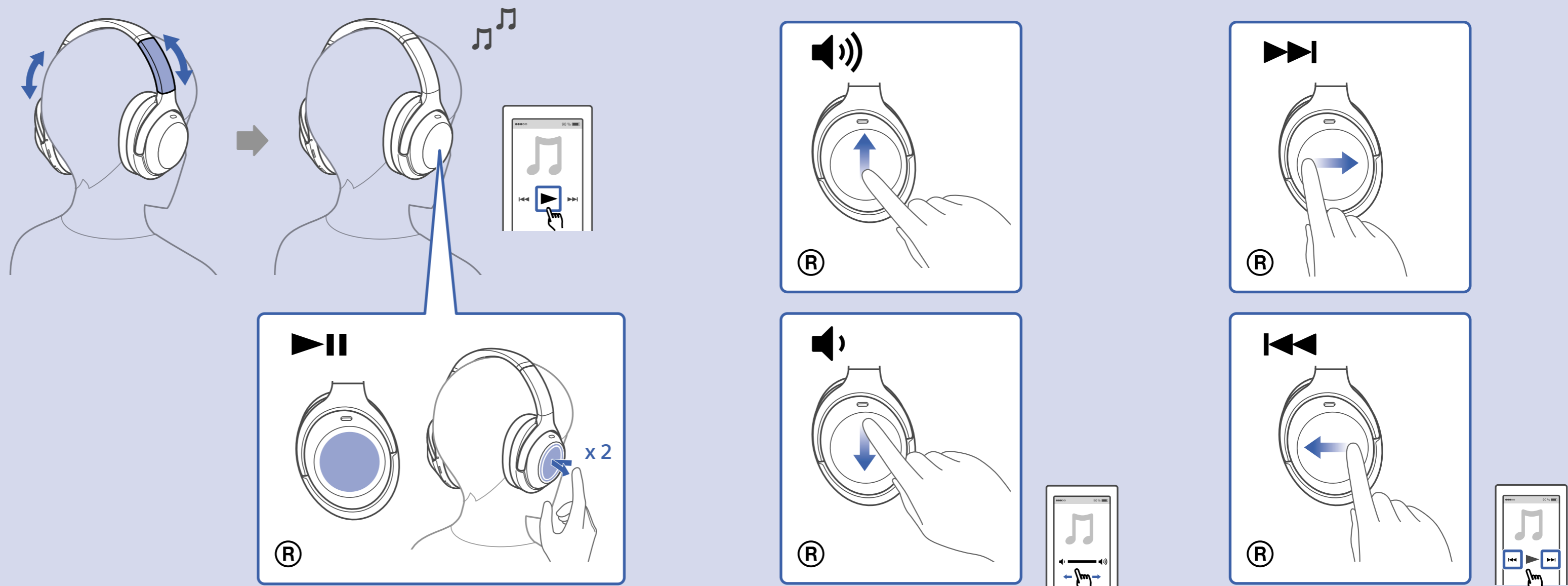

WH-1000XM3

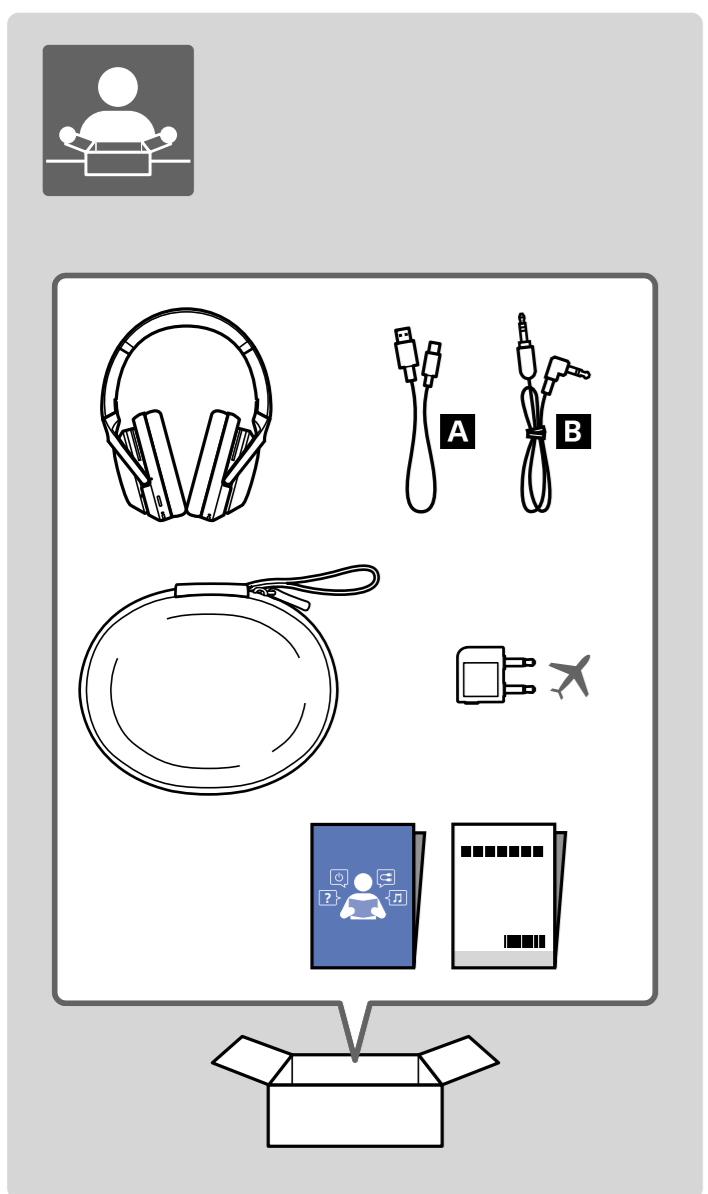

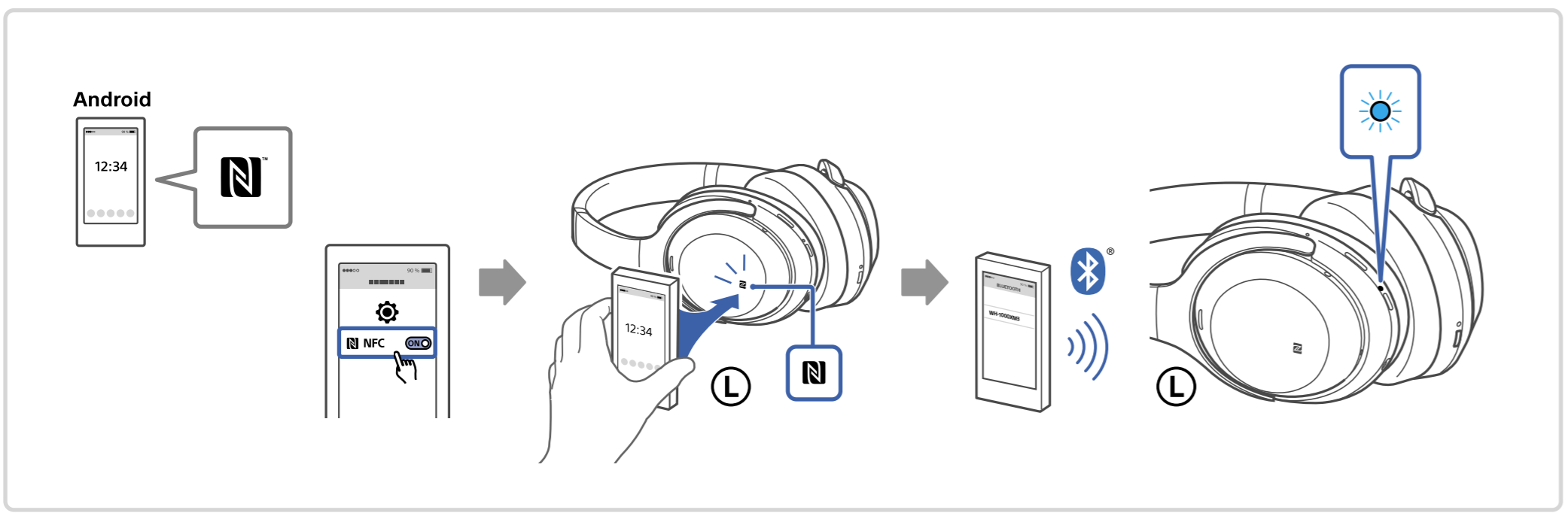
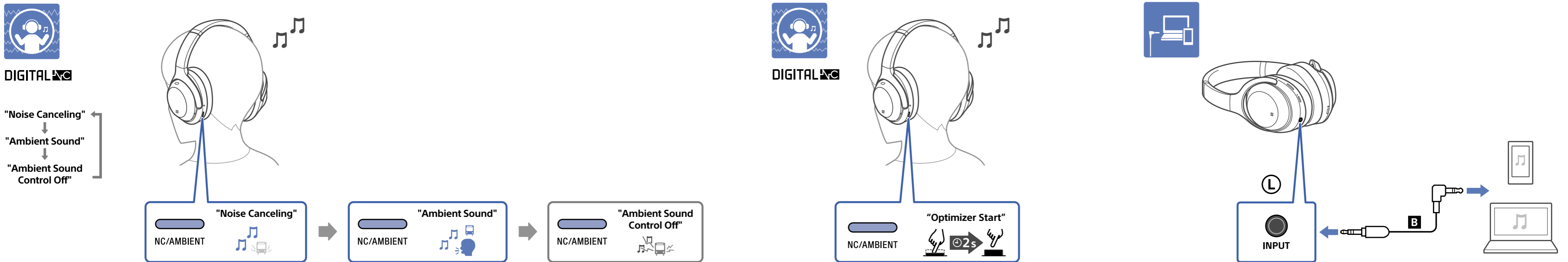
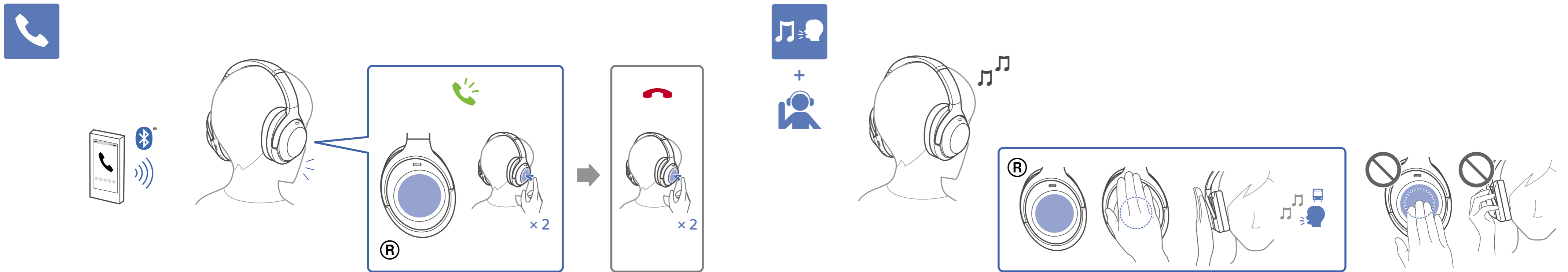
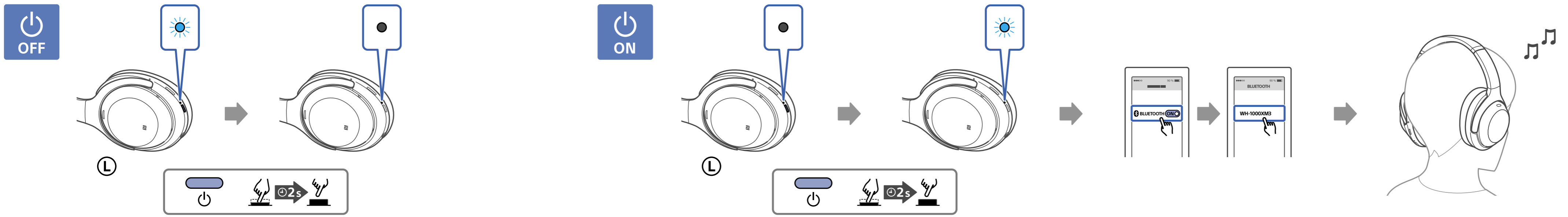

?

http://rd1.sony.net/help/mdr/wh1000xm3/h_zz/

The block contains a QR code and a support URL for the headphones. Below the QR code and URL are icons of a laptop and a smartphone displaying the support page.