

Ultra HD Blu-ray™ / DVD Player

Operating Instructions

Thank you for your purchase. Before using this player, please read this operating instructions carefully. The software of this player may be updated in the future. Please visit the following website:

www.sony.eu/support

Getting Started

Playback

Settings and Adjustments

Additional Information



Contents

WARNING	3
PRECAUTIONS	4
About wireless LAN security	6
Notes About the Discs	6

Getting Started

Supplied Accessories	7
Inserting batteries into the remote control	7
Guide to Parts and Controls	8
Front panel	8
Rear panel	8
Remote	9
Code numbers of controllable TVs	10
Step 1: Connecting the Player	11
Connecting to your TV	11
Connecting to your TV via Sound Bar/AV amplifier (receiver)	12
Step 2: Network Connection	13
Wired Setup	13
Wireless Setup	13
Step 3: Easy Setup	14
Home screen display	14
Available options	14

Playback

Playing a Disc	15
Enjoying Blu-ray 3D	15
Enjoying 4K Ultra HD Blu-ray	15
Playing from a USB Device	15
Playing via a Network	16
Playing files on a Home Network	16
Using "Video & TV SideView"	16
Using Screen mirroring	16
Available Options	17

Settings and Adjustments

Using the Settings Displays	19
[Software Update]	19
[Screen Settings]	19
[Audio Settings]	21
[BD/DVD Viewing Settings]	21
[Parental Control Settings]	22
[Music Settings]	22
[System Settings]	22
[Network Settings]	23
[Easy Setup]	23
[Resetting]	24

Additional Information

Troubleshooting	25
Picture	25
Sound	25
Disc	26
USB device	26
Internet streaming	26
Network connection	26
Control for HDMI (BRAVIA Sync)	27
Others	27
Playable discs	28
Playable types of files	29
Specifications	31
Copyrights and Trademarks	32
Language code list	34
Parental control/area code	35

Internet Connection and Data Privacy

This product connects to the internet during initial setup as soon as a network is connected in order to confirm internet connection, and later to configure the Home screen. Your IP address is used in these and all other internet connections. If you do not want your IP address be used at all, do not set-up the wireless internet function and do not connect an internet cable. Please refer to the privacy information presented in the set-up screens for further details of internet connections.

WARNING

To reduce the risk of fire or electric shock, do not expose this appliance to dripping or splashing, and do not place objects filled with liquids, such as vases, on the appliance.

To avoid electrical shock, do not open the cabinet. Refer servicing to qualified personnel only.

The mains lead must be changed only at a qualified service shop.

Do not expose batteries or appliances with battery-installed to excessive heat, such as sunshine and fire.

CAUTION

The use of optical instruments with this product will increase eye hazard. As the laser beam used in this Ultra HD Blu-ray / DVD player is harmful to eyes, do not attempt to disassemble the cabinet.

Refer servicing to qualified personnel only.

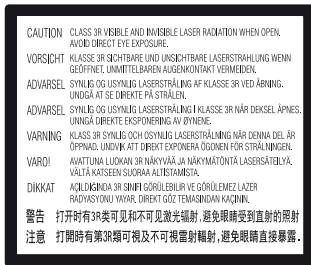

This label is located on the laser protective housing inside the enclosure.



This appliance is classified as a CLASS 1 LASER product. The CLASS 1 LASER PRODUCT MARKING is located on the rear exterior.

Notice for customers in the United Kingdom and Republic of Ireland

A molded plug complying with BS1363 is fitted to this equipment for your safety and convenience. Should the fuse in the plug supplied need to be replaced, a fuse of the same rating as the supplied one and approved by ASTA or BSI to BS1362, (i.e., marked with ⚡ or ⚡ mark) must be used. If the plug supplied with this equipment has a detachable fuse cover, be sure to attach the fuse cover after you change the fuse. Never use the plug without the fuse cover. If you should lose the fuse cover, please contact your nearest Sony service station.



Disposal of waste batteries and electrical and electronic equipment (applicable in the European Union and other European countries with separate collection systems)

This symbol on the product, the battery or on the packaging indicates that the product and the battery shall not be treated as household waste. On certain batteries this symbol might be used in combination with a chemical symbol. The chemical symbols for mercury (Hg) or lead (Pb) are added if the battery contains more than 0.0005% mercury or 0.004% lead. By ensuring these products and batteries are disposed of correctly, you will help prevent potentially negative consequences for the environment and human health which could otherwise be caused by inappropriate waste handling. The recycling of the materials will help to conserve natural resources.

In case of products that for safety, performance or data integrity reasons require a permanent connection with an incorporated battery, this battery should be replaced by qualified service staff only. To ensure that the battery and the electrical and electronic equipment will be treated properly, hand over these products at end-of-life to the applicable collection point for the recycling of electrical and electronic equipment. For all other batteries, please view the section on how to remove the battery from the product safely. Hand the battery over to the applicable collection point for the recycling of waste batteries. For more detailed information about recycling of this product or battery, please contact your local Civic Office, your household waste disposal service or the shop where you purchased the product or battery.

This product has been manufactured by or on behalf of Sony Corporation.

EU Importer: Sony Europe Limited.

Inquiries to the EU Importer or related to product compliance in Europe should be sent to the manufacturer's authorized representative, Sony Belgium, bijkantoor van Sony Europe Limited, Da Vincilaan 7-D1, 1935 Zaventem, Belgium.

Notice for the customers in Europe



Hereby, Sony Corporation declares that this equipment is in compliance with Directive 2014/53/EU.

The full text of the EU declaration of conformity is available at the following internet address: <http://www.compliance.sony.de/>

PRECAUTIONS

- This unit operates on 220 V - 240 V AC, 50/60 Hz. Check that the unit's operating voltage is identical with your local power supply.
- Install this unit so that the AC power cord (mains lead) can be unplugged from the wall socket immediately in the event of trouble.
- This equipment has been tested and found to comply with the limits set out in the EMC Regulation using a connection cable shorter than 3 metres.
- Place the player in a location with adequate ventilation to prevent heat build-up in the player.
- To reduce the risk of fire, do not cover the ventilation opening of the appliance with newspapers, tablecloths, curtains, etc.
- Do not expose the appliance to naked flame sources (for example, lighted candles).
- Do not install this player in a confined space, such as a bookshelf or similar unit.
- Do not place the player outdoors, in vehicles, on ships, or on other vessels.
- If the player is brought directly from a cold to a warm location, or is placed in a very damp room, moisture may condense on the lenses inside the player. Should this occur, the player may not operate properly. In this case, remove the disc and leave the player turned on for about half an hour until the moisture evaporates.
- Do not install the player in an inclined position. It is designed to be operated in a horizontal position only.
- Do not place metal objects in front of the front panel. It may limit reception of radio waves.
- Do not place the player in a place where medical equipment is in use. It may cause a malfunction of medical instruments.
- If you use a pacemaker or other medical device, consult your physician or the manufacturer of your medical device before using the wireless LAN function.
- This player should be installed and operated with a minimum distance of at least 20 cm or more between the player and a person's body (excluding extremities: hands, wrists, feet and ankles).
- Do not place heavy or unstable objects on the player.
- Do not place any objects other than discs on the disc tray. Doing so may cause damage to the player or the object.
- Take out any discs from the tray when you move the player. If you don't, the disc may be damaged.
- Disconnect the AC power cord (mains lead) and all other cables from the player when you move the player.
- The AC power cord (mains lead) is not disconnected from the mains as long as it is connected to the AC outlet, even if the player itself has been turned off.
- Disconnect the player from the wall outlet if you are not going to use the player for a long time. To disconnect the AC power cord (mains lead), grasp the plug itself; never pull the cord.
- Observe following points to prevent the AC power cord (mains lead) being damaged. Do not use the AC power cord (mains lead) if it is damaged, as doing so may result in an electric shock or fire.
 - Do not pinch the AC power cord (mains lead) between the player and wall, shelf, etc.
 - Do not put anything heavy on the AC power cord (mains lead) or pull on the AC power cord (mains lead) itself.

- Use the supplied AC adaptor for this player, as other adaptors may cause a malfunction.
- Do not disassemble or reverse-engineer the AC adaptor.
- Do not confine the AC adaptor in a closed place such as a bookshelf or an AV cabinet.
- Do not connect the AC adaptor to a traveler's electric transformer, which may generate heat and cause a malfunction.
- Do not drop or apply shock to the AC adaptor.
- Do not turn up the volume while listening to a section with very low level inputs or no audio signals. Your ears and the speakers may be damaged when the sound level reaches the peak.
- Clean the cabinet, panel, and controls with a soft cloth. Do not use any type of abrasive pad, scouring powder or solvent such as alcohol or benzine.
- Do not use cleaning discs or disc/lens cleaners (including wet or spray types). These may cause the apparatus to malfunction.
- In the events that this player is repaired, repaired parts may be collected for reuse or recycling purposes.
- Observe the following as improper handling may damage the HDMI OUT jack and the connector.
 - Carefully align the HDMI OUT jack on the rear of the player and the HDMI connector by checking their shapes. Make sure the connector is not upside down or tilted.

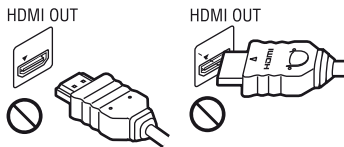

- Be sure to disconnect the HDMI cable when moving the player.



- Hold the HDMI connector straight when connecting or disconnecting the HDMI cable. Do not twist or force the HDMI connector into the HDMI OUT jack.

On watching 3D video images

Some people may experience discomfort (such as eye strain, fatigue, or nausea) while watching 3D video images. Sony recommends that all viewers take regular breaks while watching 3D video images. The length and frequency of necessary breaks will vary from person to person. You must decide what works best. If you experience any discomfort, you should stop watching the 3D video images until the discomfort ends; consult a doctor if you believe necessary. You should also review (i) the instruction manual and/or the caution message of any other device used with, or Blu-ray Disc contents played with this product and (ii) our website (www.sony.eu/myproducts/) for the latest information. The vision of young children (especially those under six years old) is still under development. Consult your doctor (such as a pediatrician or eye doctor) before allowing young children to watch 3D video images. Adults should supervise young children to ensure they follow the recommendations listed above.

IMPORTANT NOTICE

Caution: This player is capable of holding a still video image or on-screen display image on your television screen indefinitely. If you leave the still video image or on-screen display image displayed on your TV for an extended period of time you risk permanent damage to your television screen. Plasma display panel televisions and projection televisions are susceptible to this.

If you have any questions or problems concerning your player, please consult your nearest Sony dealer.

About wireless LAN security

Since communication via the wireless LAN function is established by radio waves, the wireless signal may be susceptible to interception. To protect wireless communication, this player supports various security functions. Be sure to correctly configure the security settings in accordance with your network environment.

◆ No Security

Although you can easily make settings, anyone can intercept wireless communication or intrude into your wireless network, even without any sophisticated tools. Keep in mind that there is a risk of unauthorised access or interception of data.

◆ WEP

WEP applies security to communications to prevent outsiders from intercepting communications or intruding into your wireless network. WEP is a legacy security technology that enables older devices, which do not support TKIP/AES, to be connected.

◆ WPA-PSK (TKIP), WPA2-PSK (TKIP)

TKIP is a security technology developed to correct the deficiencies of WEP. TKIP assures a higher security level than WEP.

◆ WPA-PSK (AES), WPA2-PSK (AES)

AES is a security technology that uses an advanced security method that is distinct from WEP and TKIP.

AES assures a higher security level than WEP or TKIP.

Notes About the Discs

- To keep the disc clean, handle the disc by its edge. Do not touch the surface. Dust, fingerprints, or scratches on the disc may cause it to malfunction.
- Do not expose the disc to direct sunlight or heat sources such as hot air ducts, or leave it in a car parked in direct sunlight as the temperature may rise considerably inside the car.
- After playing, store the disc in its case.
- Clean the disc with a cleaning cloth. Wipe the disc from the center out.
- Do not use solvents such as benzine, thinner, commercially available disc/lens cleaners, or anti-static spray intended for vinyl LPs.
- If you have printed the disc's label, dry the label before playing.
- Do not use the following discs.
 - A lens cleaning disc.
 - A disc that has a non-standard shape (e.g., card, heart).
 - A disc with a label or sticker on it.
 - A disc that has cellophane tape or sticker adhesive on it.
- Do not resurface the playing side of a disc to remove surface scratches.



Supplied Accessories

- AC adaptor (AC-M1215WW) (1)
- AC power cord (mains lead) (1)
- Remote commander (remote) (1)
- R03 (size AAA) batteries (2)

Inserting batteries into the remote control

Insert two R03 (size AAA) batteries by matching the + and – ends on the batteries to the markings inside the battery compartments of the remote.

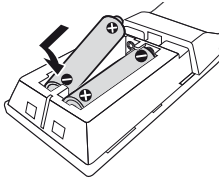

Guide to Parts and Controls

Front panel

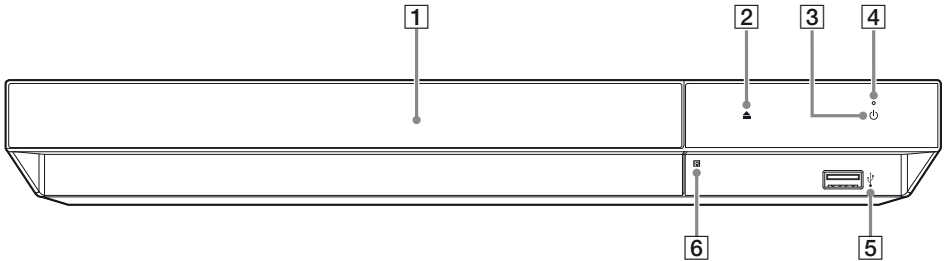

- 1 Door**
- 2 ▲ (open/close)**
- 3 ⏻ (on/standby)**
Turns on the player, or sets to standby mode.
- 4 Power indicator**
Lights up when the player is turned on.
- 5 USB jack**
Connect a USB device to this jack. See page 15.
- 6 Remote sensor**

Rear panel

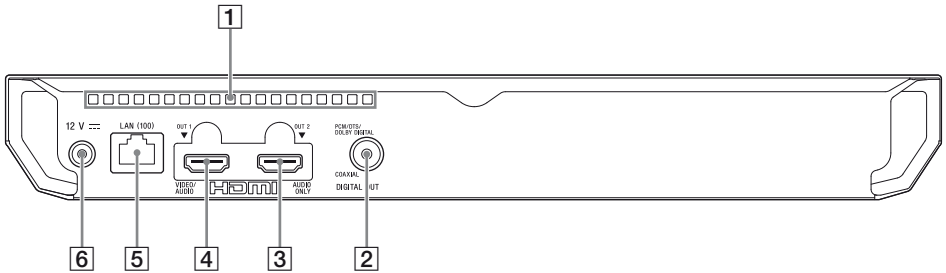

- 1 Ventilation holes**
- 2 DIGITAL OUT (COAXIAL) jack**
- 3 HDMI OUT 2 jack (AUDIO ONLY)**
Outputs digital audio signal only.
- 4 HDMI OUT 1 jack (VIDEO/AUDIO)**
Outputs digital video and audio signal.
- 5 LAN (100) terminal**
- 6 DC IN 12 V (AC adaptor input) jack**

Remote

The available functions of the remote are different depending on the disc or the situation.

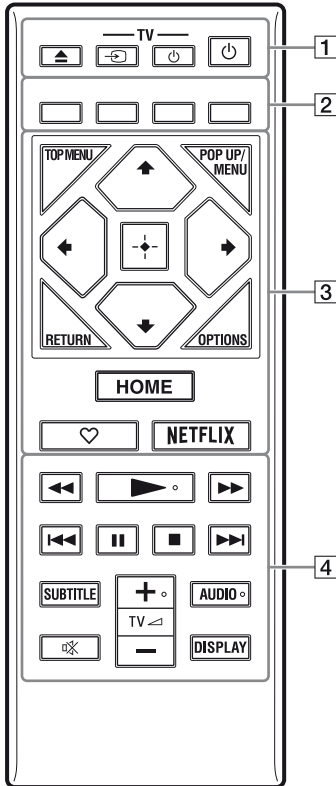

▶, TV ↙ +, and AUDIO buttons have a tactile dot. Use the tactile dot as a reference when operating the player.

1 ▲ (open/close)

Opens or closes the door tray.

-TV- ↻ (TV input select)

Switches between TV and other input sources.

-TV- ⏻ (TV on/standby)

Turns on the TV, or sets to standby mode.

⏻ (on/standby)

Turns on the player, or sets to standby mode.

2 Colour buttons (red/green/yellow/blue)

Shortcut keys for interactive functions.

3 TOP MENU

Opens or closes the Ultra HD Blu-ray/BD/DVD's Top Menu.

POP UP/MENU

Opens or closes the Ultra HD Blu-ray/BD/DVD's menu.

OPTIONS (page 17)

Displays the available options on the screen.

RETURN

Returns to the previous display.



Moves the highlight to select a displayed item.



- ▲/▼ as a shortcut key to launch track search window and input track number during music CD playback.
- ▲/▼ as a shortcut key to rotate photo clockwise/counterclockwise by 90 degrees.
- ◀/▶ as a shortcut key to perform seek functions during Home Network video playback.
- ◀/▶ as a shortcut key to change still image when it is enabled to change.

Centre button (ENTER)

Enters the selected item.

HOME

Enters the player's home screen.

♥ (favourite) (page 14)

Accesses the application registered as favourite.

NETFLIX

Accesses the "NETFLIX" online service. For further NETFLIX online service details, visit the following website and check the FAQ: www.sony.eu/support

4 ◀◀/▶▶ (fast reverse/fast forward)

- Fast reverse/fast forward the disc when pressed during playback. The search speed changes each time you press the button.
- Plays in slow motion when pressed for more than one second in pause mode.
- Plays one frame at a time when pressed for a short time in pause mode.

▶ (play)

Starts or re-starts playback.

◀◀/▶▶ (previous/next)

Skips to the previous/next chapter, track, or file.

II (pause)

Pauses or re-starts playback.

■ (stop)

Stops playback and remembers the stop point (resume point).

The resume point for a title/track is the last point you played or the last photo for a photo folder.

SUBTITLE (page 21)

Selects the subtitle language when multilingual subtitles are recorded on Ultra HD Blu-ray/BD/DVD.

TV ▲ (volume) +/-

Adjusts the TV volume.

AUDIO (page 21)

Selects the language track when multilingual tracks are recorded on Ultra HD Blu-ray/BD/DVD.

Selects the sound track on CDs.

🔇 (muting)

Turns off the TV sound temporarily.

DISPLAY

Displays the playback information on the screen.

To lock the disc tray (Child Lock)

You can lock the disc tray to avoid accidental opening of the tray.

While the player is turned on, press ■ (stop), HOME, and then TOP MENU button on the remote to lock or unlock the tray.

Code numbers of controllable TVs

Press and hold -TV- ⏻, and then press and hold the TV manufacturer's code using the remote button for more than 2 seconds. If more than one remote button is listed, try entering them one at a time until you find the one that works with your TV.

Example: If your TV is Hitachi, press and hold -TV- ⏻, and then press and hold TOP MENU for more than 2 seconds.

Manufacturer	Remote Button
Sony (Default)	Colour button (red)
Philips	Colour button (green) / Colour button (yellow) / RETURN
Panasonic	Colour button (blue) / Centre button (ENTER)
Hitachi	TOP MENU
Sharp	↑
Toshiba	POP UP/MENU
Loewe	←
Samsung	→
LG/Goldstar	↓

Step 1: Connecting the Player

Do not connect the mains lead until you have made all the connections.

Connecting to your TV

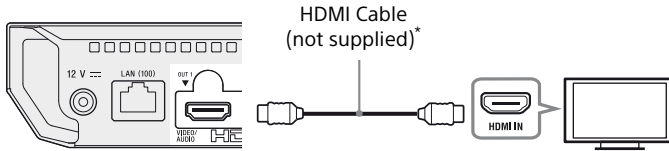

* Premium High Speed HDMI Cable or High Speed HDMI Cable that supports 18 Gbps bandwidth.



- To enjoy 4K Ultra HD 60p content, you need to connect the player to your 4K TV using Premium High Speed HDMI Cable or High Speed HDMI Cable that supports 18 Gbps bandwidth.
- 4K output requires a compatible 4K display which has HDCP2.2 capable HDMI input.
- If you use BRAVIA TV that supports 4K60p, set the TV's "HDMI signal format" setting to "Enhanced format".

Connecting to your TV via Sound Bar/AV amplifier (receiver)

Select **A**, **B** or **C** connection methods according to the input jacks on your AV amplifier (receiver).

A 4K AV amplifier (receiver)

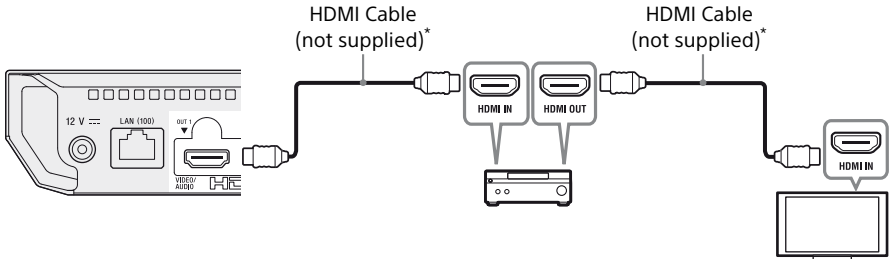

B Non-4K AV amplifier (receiver) with HDMI IN

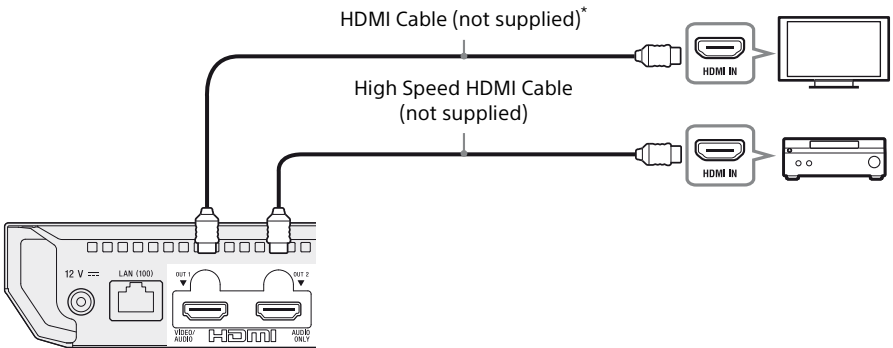

C Non-4K AV amplifier (receiver) without HDMI IN

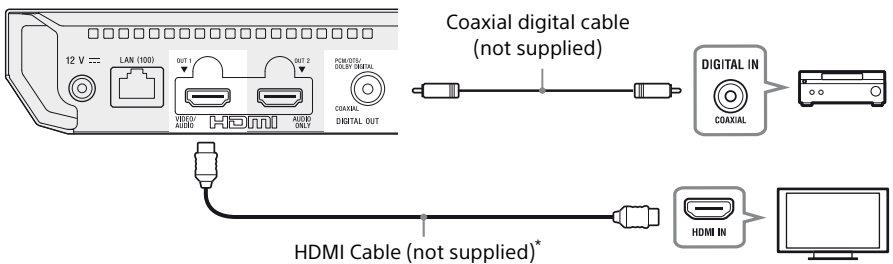

* Premium High Speed HDMI Cable or High Speed HDMI Cable that supports 18 Gbps bandwidth.

Step 2: Network Connection

If you are not going to connect the player to a network, proceed to “Step 3: Easy Setup” (page 14).

Wired Setup

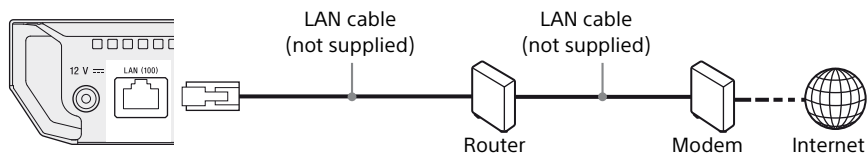

The use of a shielded and straight interface cable (LAN cable) is recommended.

Wireless Setup



No cable assembly required between the player and the wireless LAN router.

Step 3: Easy Setup

When turned on for the first time

Wait for a short while before the player turns on and starts [Easy Setup].



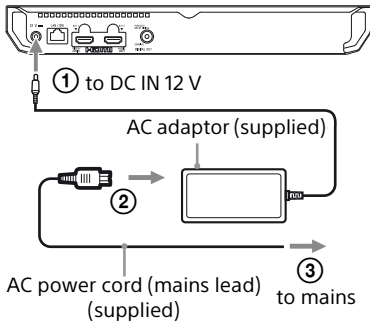

- 1 Connect the supplied AC adaptor and AC power cord (mains lead) in the numeric order shown below. When removing them, do so in reverse order.

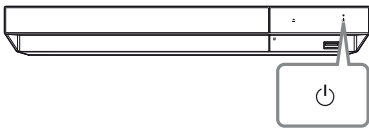

- 2 Press  to turn on the player. Power indicator lights up.





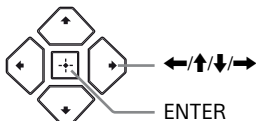

- 3 Turn on the TV and press TV  button on the remote to set the input selector. This will show the signal from the player on your TV screen.

- 4 Perform [Easy Setup]. Follow the on-screen instructions to make the basic settings using , , ,  and press ENTER on the remote.



- When [Easy Setup] is complete, select [Easy Network Settings] to use the network functions of the player.
- To enable wireless connection, set [Internet Settings] in [Network Settings] to [Wireless Setup].
- To disable wireless connection, set [Internet Settings] in [Network Settings] to [Wired Setup].
- If there is no output or black screen appears, refer to "Troubleshooting" (page 25).

Home screen display

The home screen appears when you press HOME. Select an application using , , , , and press ENTER.

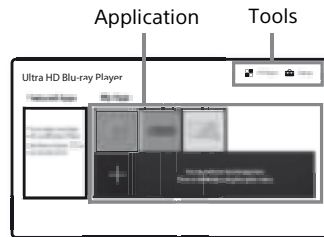

[My Apps]: Manages favourite application. You may add shortcuts for application from [All Apps].

[Featured Apps]: Displays recommended application.

[All Apps]: Shows all available applications. You can add applications to [My Apps] by pressing OPTIONS, and select [Add to My Apps].

[Setup]: Adjusts the player's settings.

Available options

Various settings and playback operations are available by pressing OPTIONS. The available items differ depending on the situation.

[Move Application]: Arranges applications in [My Apps].

[Remove Application]: Deletes applications in [My Apps].

[Register as Favourite]: Registers 1 application into  (favourite) remote button.

[Data Contents]: Displays the contents of the mixed disc.

Playing a Disc

You can play Ultra HD Blu-ray discs, BDs, DVDs and CDs. For "Playable discs", see page 28.

- 1 Press ▲ (open/close), and place a disc on the disc tray.
Place the disc's side with character or image facing up.
For double-sided discs, place the side you want to play facing down.

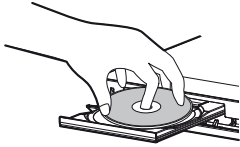

- 2 Press ▲ (open/close) to close the disc tray.
Playback starts.
If playback does not start automatically, select [Video], [Music], or [Photo] category in ● (Disc), and press ENTER.



● (Mixed disc) contains data contents. Press OPTIONS on the remote and select [Data Contents] to display any available contents.

Enjoying Blu-ray 3D

- 1 Prepare for Blu-ray 3D disc playback.
 - Connect the player to your 3D-compatible devices using a High Speed HDMI Cable.
 - Set [3D Output Setting] and [TV Screen Size Setting for 3D] in [Screen Settings] (page 19).
- 2 Insert a Blu-ray 3D disc.
The operation method differs depending on the disc. Refer to the instruction manual supplied with the disc.



Refer also to the instruction manuals supplied with your TV and the connected device.

Enjoying 4K Ultra HD Blu-ray

- 1 Prepare for 4K Ultra HD Blu-ray playback.
 - Connect the player to your 4K TV using a Premium High Speed HDMI Cable.
 - To view 4K Ultra HD 60p content, make sure that the proper setting is selected in HDMI settings on your TV.
 - If you use BRAVIA TV that supports 4K60p, set the TV's "HDMI signal format" setting to "Enhanced format".
- 2 Insert a 4K Ultra HD Blu-ray disc.
The operation method differs depending on the disc. Refer to the instruction manual supplied with the disc.



When playing a 4K Ultra HD Blu-ray disc with no disc key, it requires network connection depending on the network environment and official key server (Studio).

Playing from a USB Device

For "Playable types of files", see page 29.

- 1 Connect the USB device to the USB jack on the player.



- 2 Select ■ [USB device] using ←/↑/↓/→, and press ENTER.
- 3 Select [Video], [Music], or [Photo] category using ↑/↓, and press ENTER.



To avoid data corruption or damage to the USB device, turn off the player when connecting or removing the USB device.

Playing via a Network

Playing files on a Home Network

A Home Network-compatible product can play video/music/photo files stored on another Home Network-compatible product via a network.

Prepare to use Home Network.

- 1 Connect the player to a network (page 13).
- 2 Prepare the other necessary Home Network-compatible products. Refer to the instruction manual supplied with the product.

To play a file from a Home Network server via this unit (Home Network player)

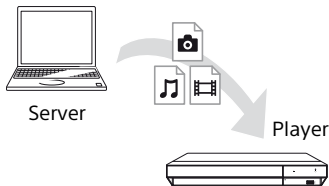

Select [Video], [Music], or [Photo] category from  [Media Server] in [All Apps], then choose the file you want to play.

To play a file from a Home Network server via another product (Renderer)

When you play files from a Home Network Server on this unit, you can use a Home Network Controller-compatible product (a phone, etc.), to control playback.

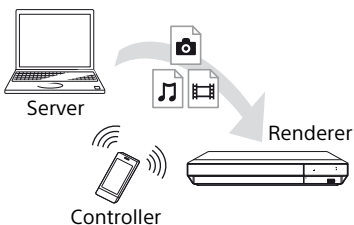

Control this unit using a Home Network controller. Refer to the instruction manual supplied with the Home Network controller.

Using "Video & TV SideView"

"Video & TV SideView" is a free mobile application for remote devices (such as smartphone, etc.). By using "Video & TV SideView" with this player, you can easily enjoy the player by using the operation on your remote device. You can launch a service or application directly from the remote device. "Video & TV SideView" also can be used as a remote control and software keyboard.

Before you use the "Video & TV SideView" device with this player for the first time, be sure to register the "Video & TV SideView" device. Follow the on-screen instructions on the "Video & TV SideView" device for registration.



The registration can only be performed on the home screen.





Using Screen mirroring

 "Screen mirroring" is a function to display the screen of a mobile device on the TV by Miracast technology.

The player can be connected directly with a Screen mirroring compatible device (e.g. smartphone, tablet). You can enjoy the display screen of the device on your large TV screen. No wireless router (or access point) is required to use this feature.



- When using Screen mirroring, the quality of picture and sound may sometimes be deteriorated due to interference from other network. You may improve by adjusting [Screen mirroring RF Setting] (page 23).
- Some network functions may not be available during Screen mirroring.
- Make sure that the device is compatible with Miracast. Connectivity with all Miracast compatible devices is not guaranteed.

- 1 Select  [Screen mirroring] from home screen using ///, and press ENTER.
- 2 Follow the on-screen instructions.

Available Options

Various settings and playback operations are available by pressing **OPTIONS**. The available items differ depending on the situation.

Common options

- **[Repeat Setting]^{*1}**: Sets the repeat mode.
- **[Play]/[Stop]**: Starts or stops the playback.
- **[Play from start]**: Plays the item from the beginning.

Video only

- **[3D Output Setting]**: Sets whether or not to output 3D video automatically.
- **[A/V SYNC]**: Adjusts the gap between picture and sound, by delaying the sound output in relation to the picture output (0 to 120 milliseconds).
- **[HDR Conversion]^{*2}**: Converts High Dynamic Range (HDR) signal to Standard Dynamic Range (SDR) signal when the player is connected to a TV or a Projector that does not support HDR input. A picture is more similar to HDR when larger value is selected, but lowers overall brightness.
- **[Video Settings]^{*3}**:
 - [Picture Quality Mode]: Selects the picture settings for different lighting environments.
 - [Direct]
 - [Brighter Room]^{*4}
 - [Theatre Room]^{*4}
 - [Auto]: Noise reduction (NR) mode control depends on media and contents.
 - [Custom1]/[Custom2]
 - [FNR]: Reduces the random noise appearing in the picture.
 - [BNR]: Reduces the mosaic-like block noise in the picture.
 - [MNR]: Reduces minor noise around the picture outlines (mosquito noise).
 - [Contrast]
 - [Brightness]
 - [Colour]
 - [Hue]
- **[Pause]**: Pauses the playback.

- **[Top Menu]**: Displays the Ultra HD Blu-ray/BD/DVD's Top Menu.
- **[Menu]/[Pop-up Menu]**: Displays the Ultra HD Blu-ray/BD's Pop-up Menu or DVD's menu.
- **[Title Search]**: Searches for a title on Ultra HD Blu-ray/BD/DVD VIDEO and starts playback from the beginning.
- **[Chapter Search]**: Searches for a chapter and starts playback from the beginning.
- **[Audio]**: Switches the language track when multilingual tracks are recorded on Ultra HD Blu-ray/BD/DVD. Selects the sound track on CDs.
- **[Subtitle]**: Switches the subtitle language when multilingual subtitles are recorded on Ultra HD Blu-ray/BD/DVD.
- **[Angle]**: Switches to other viewing angles when multi-angles are recorded on Ultra HD Blu-ray/BD/DVD.
- **[Number Entry]**: Selects the number by using **←/↑/↓/→** key on the remote.

Music only

- **[Track Search]**: Searches the track number during music CD playback.
- **[Add Slideshow BGM]**: Registers music files in the USB memory as slideshow background music (BGM).
- **[Shuffle Setting]**: Set to [On] to playback music files in randomised order.

Photo only

- **[Slideshow Speed]**: Changes the slideshow speed.
- **[Slideshow Effect]**: Sets the effect for slideshows.
- **[Slideshow BGM]^{*5}**:
 - [Off]: Turns off the function.
 - [My Music from USB]: Sets the music files registered in [Add Slideshow BGM].
 - [Play from Music CD]: Sets the tracks in CD-DAs.
- **[2D Playback]^{*6}**: Sets playback to 2D image.
- **[Change Display]**: Switches between [Grid View] and [List View].

- **[View Image]:** Displays the selected photo.
- **[Slideshow]:** Plays a slideshow.
- **[Rotate Left]:** Rotates the photo counterclockwise by 90 degrees.
- **[Rotate Right]:** Rotates the photo clockwise by 90 degrees.









- *1 [Repeat Setting] is not available during BDJ titles playback or HDMV interactive title.
- *2 [HDR Conversion] is only available during HDR video playback, when your display device is not compatible with HDR display, or when [HDR Output] in [Screen Settings] is set to [Off].
- *3 [Video Settings] output may not be significantly observed with normal eyes.
- *4 [Brighter Room] and [Theatre Room] are not available during HDR video playback.
- *5 [Slideshow BGM] is not available during Home Network photo playback.
- *6 [2D Playback] is only available during 3D photo playback.

Using the Settings Displays

Select  [Setup] on the home screen when you need to change the settings of the player.

The default settings are underlined.

- 1 Select  [Setup] on the home screen using ///.
- 2 Select the setup category icon using /, and press ENTER.

[Software Update]

■ [Update via Internet]

Updates the player's software using available network. Make sure that the network is connected to the Internet. See "Step 2: Network Connection" (page 13).

■ [Update via USB Memory]

Updates the player's software using USB memory. Create a folder named "UPDATE" and all the update files must be stored in this folder. The player can recognise up to 500 files/folders in a single layer including the update files/folders.



- We recommend performing the software update every 2 months or so.
- If your network condition is poor, visit www.sony.eu/support to download the latest software version and update via USB memory. You can also get information about update functions from the website.

[Screen Settings]

■ [HDR Output]

[Auto]: Outputs HDR signal depending on contents and HDMI-SINK capability. Conversion function is applied when content is HDR and HDMI-SINK does not support HDR. [Off]: Always output SDR.

■ [Display Type]

[TV]: Select this when the player is connected to TV.

[Projector]: Select this when the player is connected to Projector.



[HDR Conversion] will be adjusted according to the display type you select. Even though same setting value of [HDR Conversion] is selected, dynamic range of picture is different.

■ [Output Video Resolution]

Normally select [Auto]. When the resolution is lower than the SD resolution, it is scaled up to the SD resolution.

■ [24p Output]

Outputs 24p video signals only when you connect a 24p-compatible TV via an HDMI connection and the [Output Video Resolution] is set to [Auto], [1080p] or [4K].

[Ultra HD Blu-ray/BD-ROM]

[Auto]: Outputs 24 Hz video signals only when connecting a 24p-compatible TV using the HDMI OUT jack.

[On]: Turns on the function.

[Off]: Select this when your TV is not compatible with 24p video signals.

[DVD-ROM]

[Auto]: Outputs 24 Hz video signals only when connecting a 24p-compatible TV using the HDMI OUT jack.

[Off]: Select this when your TV is not compatible with 24p video signals.

[Data content]

This function is available for playback contents stored in USB memory or data disc.

[Auto]: Outputs 24 Hz video signals only when connecting a 24p-compatible TV using the HDMI OUT jack.

[Off]: Select this when your TV is not compatible with 24p video signals.

■ [Network content]

This function is available for playback contents from other network, such as Home Network, Screen mirroring, etc.

[Auto]: Outputs 24 Hz video signals only when connecting a 24p-compatible TV using the HDMI OUT jack.

[Off]: Select this when your TV is not compatible with 24p video signals.

■ [4K Upscale Setting]

[Auto1]: Outputs 2K (1920 × 1080) video signals during video playback and 4K video signals during photo/Network Services/Miracast playback when connecting to a Sony 4K-compatible equipment.

Outputs 4K video signals when connecting to a non-Sony 4K-compatible equipment. This setting does not work for 3D video image playback.

[Auto2]: Automatically outputs 4K video signals when you connect a 4K-compatible equipment.

[Off]: Turns off the function.



If your Sony equipment is not detected when [Auto1] is selected, the setting will have the same effect as [Auto2] setting.

■ [YCbCr/RGB (HDMI)]

[Auto]: Automatically detects the connected TV type, and switches to the matching colour setting.

[YCbCr (4:2:2)]: Outputs YCbCr 4:2:2 video signals.

[YCbCr (4:4:4)]: Outputs YCbCr 4:4:4 video signals.

[RGB]: Outputs RGB video signals.

■ [HDMI Deep Colour Output]

[Auto]: Outputs 12bit/10bit video signals when the connected TV is compatible with Deep Colour.

[Off]: Select this when the picture is unstable or colours appear unnatural.

■ [IP Content NR]

[Auto] / [Strong] / [Medium] / [Mild]: Adjust the picture quality for Internet content.

[Off]: Turns off the function.

■ [3D Output Setting]

[Auto]: Normally select this.

[Off]: Select this to display all content in 2D or to enjoy 4K output using 3D content.

■ [TV Screen Size Setting for 3D]

Sets the screen size of your 3D-compatible TV.

■ [TV Type]

[16:9]: Select this when connecting to a wide-screen TV or a TV with a wide mode function.

[4:3]: Select this when connecting to a 4:3 screen TV without a wide mode function.

■ [Screen Format]

[Full]: Select this when connecting to a TV with a wide mode function. Displays a 4:3 screen picture in 16:9 aspect ratio even on a wide-screen TV.

[Normal]: Changes the picture size to fit the screen size with the original picture aspect ratio.

■ [DVD Aspect Ratio]

[Letter Box]: Displays a wide picture with black bands on the top and bottom.

[Pan & Scan]: Displays a full-height picture on the entire screen, with trimmed sides.

■ [Cinema Conversion Mode]

[Auto]: Normally select this. The player automatically detects whether the material is video-based or film-based, and switches to the appropriate conversion method.

[Video]: The conversion method suited for video-based material will always be selected regardless of the material.

■ [Pause Mode]

[Auto]: Normally select this. Dynamic moving pictures appear without blurring.

[Frame]: Displays static pictures at high resolution.

[Audio Settings]

■ [Digital Audio Output]

[Auto]: Normally select this. Outputs audio signals according to the status of the connected devices.

[PCM]: Outputs PCM signals from the DIGITAL OUT (COAXIAL)/HDMI OUT jack. Select this if there is no output from the connected device.

■ [DSD Output Mode]

[Auto]: Outputs DSD signal from HDMI OUT jack when playing Super Audio CD & DSD format file (if the connected device also supports DSD).

Outputs LPCM signal from HDMI OUT jack when playing Super Audio CD & DSD format file (if the connected device does not support DSD).

[Off]: Outputs PCM signals from HDMI OUT jack when playing Super Audio CD and DSD format file.

■ [BD Secondary Audio]

[On]: Outputs the audio obtained by mixing the interactive and secondary audio to the primary audio.

[Off]: Outputs the primary audio only. Select this to output Bitstream (Dolby/DTS) signals to an AV amplifier (receiver).



To enjoy Bitstream (Dolby/DTS) signals, set [BD Secondary Audio] to [Off] and [Digital Audio Output] to [Auto].

■ [Digital Music Enhancer]

[On]: Set the sound effect when playing Internet content or USB content.

[Off]/[Sound Bar Mode]: Turns off the function.

■ [DTS Neo:6]

[Cinema]/[Music]: Outputs the simulated multi-channel sound from 2 channel sources via the HDMI OUT jack according to the capability of the connected device using [Cinema]/[Music] mode.

[Off]: Outputs the sound with its original number of channels via the HDMI OUT jack.



When [DTS Neo:6] is set to [Cinema] or [Music], [Digital Music Enhancer] is not available.

■ [48kHz/96kHz/192kHz PCM]

[48kHz]/[96kHz]/[192kHz]: Sets the sampling frequency for the PCM signals output from the DIGITAL OUT (COAXIAL) jack.



Some device does not support [96kHz] and [192kHz] sampling frequency.

■ [Audio DRC]

[Auto]: Performs playback at the dynamic range specified by the disc (BD-ROM only).

Other discs are played back at the [On] level.

[On]: Performs playback at a standard compression level.

[Off]: No compression works. A more dynamic sound is produced.

■ [Downmix]

[Surround]: Outputs audio signals with surround effects. Select this when connecting an audio device that supports Dolby Surround (Pro Logic) or DTS Neo:6.

[Stereo]: Outputs audio signals without surround effects. Select this when connecting an audio device that does not support Dolby Surround (Pro Logic) or DTS Neo:6.

[BD/DVD Viewing Settings]

■ [BD/DVD Menu Language]

Selects the default menu language for Ultra HD Blu-ray/BD/DVD VIDEO.

Select [Select Language Code], and enter the code for your language, referring to "Language code list" (page 34).

■ [Audio Language]

Selects the default audio language for Ultra HD Blu-ray/BD/DVD VIDEO.

When you select [Original], the language given priority in the disc is selected.

Select [Select Language Code], and enter the code for your language, referring to "Language code list" (page 34).

■ [Subtitle Language]

Selects the default subtitle language for Ultra HD Blu-ray/BD/DVD VIDEO.

Select [Select Language Code], and enter the code for your language, referring to "Language code list" (page 34).

■ [BD Hybrid Disc Playback Layer]

[BD]: Plays BD layer.

[DVD/CD]: Plays DVD or CD layer.

■ [BD Internet Connection]

[Allow]: Allows Internet connection from BD contents.

[Do not allow]: Prohibits Internet connection from BD contents.

■ [Delete BD Data]

Deletes data in the USB memory.

All data stored in the buda folder will be erased.

[Parental Control Settings]

■ [Password]

Sets or changes the password for the Parental Control function. A password allows you to set a restriction on Ultra HD Blu-ray/BD/DVD VIDEO and Internet video playback. If necessary, you can differentiate the restriction levels for Ultra HD Blu-ray/BD/DVD VIDEO and Internet videos.

■ [Parental Control Area Code]

Playback of some Ultra HD Blu-ray/BD/DVD VIDEO or Internet videos can be limited according to the geographic area. Scenes may be blocked or replaced with different scenes. Follow the on-screen instructions and enter your four-digit password.

■ [BD Parental Control] / [DVD Parental Control] / [Internet Video Parental Control]

By setting Parental Control, scenes can be blocked or replaced with different scenes. Follow the on-screen instructions and enter your four-digit password.

■ [Internet Video Unrated]

[Allow]: Allows the playback of unrated Internet videos.

[Block]: Blocks the playback of unrated Internet videos.

[Music Settings]

■ [Super Audio CD Playback Layer]

[Super Audio CD]: Plays the Super Audio CD layer.

[CD]: Plays the CD layer.

■ [Super Audio CD Playback Channels]

[DSD 2ch]: Plays the 2ch area.

[DSD Multi]: Plays the multi-channel area.

[System Settings]

■ [OSD Language]

Selects on-screen display language for your player.

■ [HDMI Settings]

By connecting Sony components that are compatible with HDMI functions with a High Speed HDMI Cable, operation is simplified.

[Control for HDMI]

[On]: The following BRAVIA Sync features are available:

- One-Touch Play
 - System Power-Off
 - Language Follow
- [Off]: Turns off the function.



For details, refer to the instruction manual supplied with the TV or components. To enable the BRAVIA Sync features, connect your TV via the HDMI OUT 1 jack.

[Linked to TV-off]

[Valid]: Automatically turns off the player when the connected TV enters standby mode (BRAVIA Sync).

[Invalid]: Turns off the function.

■ [HDMI Audio Output]

[Auto]: Outputs audio signal via HDMI OUT 2 jack if it is connected to a device and the device is turned on. Otherwise, outputs audio signal via HDMI OUT 1 jack.

[HDMI1]: Outputs audio signal via HDMI OUT 1 jack.

[HDMI2]: Outputs audio signal via HDMI OUT 2 jack.

■ [Auto Standby]

[On]: Automatically returns to standby mode if no button is pressed for more than 20 minutes.

[Off]: Turns off the function.

■ [Auto Display]

[On]: Automatically displays information on the screen when changing the viewing titles, picture modes, audio signals, etc.

[Off]: Displays information only when you press DISPLAY.

■ [Software Update Notification]

[On]: Sets the player to inform you of newer software version information (page 19).

[Off]: Turns off the function.

■ [Device Name]

Displays the player's name. The player's name can be changed.

■ [System Information]

Displays the player's software version information and the MAC address.

■ [Software License Information]

Displays information about the Software License.

■ [Network Connection Diagnostics]

Checks for the proper network connection by running the network diagnostics.

■ [Screen mirroring RF Setting]

[Auto]: Sets the RF (Radio Frequency) channel band automatically for Screen mirroring connection.

[CH 1]/[CH 6]/[CH 11]: Sets CH 1/CH 6/CH 11 as priority.

■ [Connection Server Settings]

Sets whether or not to display the connected server.

■ [Auto Home Network Access Permission]

[On]: Allows automatic access from newly detected Home Network controller-compatible product.

[Off]: Turns off the function.

■ [Home Network Access Control]

Displays a list of Home Network controller-compatible products and sets whether or not to accept commands from the controllers in the list.

■ [Registered Remote Devices]

Displays a list of your registered remote devices.

■ [Remote Start]

[On]: Allows you to turn on the player by a device linked via a network.

[Off]: Turns off the function.



Set [Remote Start] to [On] and turn off the player to activate Network standby (page 31).



[Network Settings]

■ [Internet Settings]

Connect the player to the network beforehand. For details, see "Step 2: Network Connection" (page 13).

[Wired Setup]: Select this when you connect to a broadband router using a LAN cable.

[Wireless Setup]: Select this when you use the wireless LAN that is built into the player for wireless network connection.



For further details, visit the following website and check the FAQ contents:
www.sony.eu/support

■ [Network Connection Status]

Displays the current network status.



[Easy Setup]

See "Step 3: Easy Setup" (page 14).

 **[Resetting]****■ [Reset to Factory Default Settings]**

Resets the player settings to the factory default by selecting the group of settings. All the settings within the group will be reset.

■ [Initialise Personal Information]

Erases your personal information stored in the player.



If you dispose, transfer or resell this unit, please delete all Personal Information for security purposes. Please take the appropriate measures such as logging out after using a network service.

Troubleshooting

If a problem occurs while operating the player, use this troubleshooting guide to help remedy the problem before requesting repairs. If the problem persists, consult your nearest Sony dealer.

Picture

No picture or the picture is not output correctly.

- Check that all the cables are securely connected (page 11).
- Switch the input selector on your TV to display the signal from the player.
- Reset the [Output Video Resolution] to the lowest resolution by pressing ■ (stop), HOME, and then POP UP/MENU button on the remote.
- Try the following: ①Turn the player off and on again. ②Turn the connected equipment off and on again. ③Disconnect and then reconnect the HDMI cable.
- The HDMI OUT jack is connected to a DVI device that does not support copyright protection technology.
- Check the [Output Video Resolution] settings in [Screen Settings] (page 19).
- For Ultra HD Blu-ray/BD-ROM/DVD-ROM/Data content/Network content, check the [24p Output] settings in [Screen Settings] (page 19).
- For 4K output, please make sure that the player is connected to 4K display that supports HDCP2.2 capable HDMI input using Premium High Speed HDMI Cable or High Speed HDMI Cable that supports 18 Gbps bandwidth (page 11).

The display language on the screen switches automatically when connected to the HDMI OUT jack.

- When [Control for HDMI] in [HDMI Settings] is set to [On] (page 22), the display language on the screen automatically switches according to the language setting of the connected TV (if you change the setting on your TV, etc.).

Sound

No sound or the sound is not output correctly.

- Check that all the cables are securely connected (page 12).
- Switch the input selector on your AV amplifier (receiver) so that the audio signals of the player are output from your AV amplifier (receiver).
- If the audio signal does not come through the DIGITAL OUT (COAXIAL)/HDMI OUT jack, check the audio settings (page 21).
- For HDMI connections, try the following: ①Turn the player off and on again. ②Turn the connected equipment off and on again. ③Disconnect and then reconnect the HDMI cable.
- For HDMI connections, if the player is connected to a TV through an AV amplifier (receiver), try connecting the HDMI cable directly to the TV. Refer also to the instruction manual supplied with the AV amplifier (receiver).
- The HDMI OUT jack is connected to a DVI device (DVI jacks do not accept audio signals).
- The device connected to the HDMI OUT jack does not support the audio format of the player. Check the audio settings (page 21).
- Check the [HDMI Audio Output] settings in [System Settings] (page 22).

The HD Audio (Dolby Digital Plus, Dolby TrueHD, DTS-HD High Resolution Audio, DTS-HD Master Audio, Dolby Atmos and DTS:X) is not output by bitstream.

- Set [BD Secondary Audio] in [Audio Settings] to [Off] (page 21).
- Check that the AV amplifier (receiver) is compatible with each HD Audio format.

The interactive audio is not output.

- Set [BD Secondary Audio] in [Audio Settings] to [On] (page 21).

Message Code 3 [Audio outputs temporarily muted. Do not adjust the playback volume. The content being played is protected by Cinavia and is not authorized for playback on this device. For more information, see <http://www.cinavia.com>. Message Code 3.] appears on the screen when playing a disc.

- The audio track of the video that you are playing contains a Cinavia code indicating that it is an unauthorised copy of professionally-produced content (page 33).

Disc

The disc does not play.

- The disc is dirty or skewed.
- The disc is upside down. Insert the disc with the playback side facing down.
- The disc has a format that cannot be played back by this player (page 28).
- The player cannot play a recorded disc that is not correctly finalised or the disc is not in Mastered disc format.
- The region code on the BD/DVD does not match the player.

USB device

The player does not detect a USB device connected to the player.

- Make sure that the USB device is securely connected to the USB jack.
- Check if the USB device or the USB cable is damaged.
- Check if the USB device is turned on.
- If the USB device is connected via a USB hub, connect the USB device directly to the player.

Internet streaming

The picture/sound is poor/certain programmes display a loss of detail, especially during fast-motion or dark scenes.

- Picture/sound quality may be improved by changing the connection speed. Recommended connection speed is of at least 2.5 Mbps for standard definition video, 10 Mbps for high definition video and at least 25 Mbps for Ultra HD video (depending on the service provider).

There is no options menu during Internet streaming.

- Options menu is not available during Internet streaming.

Network connection

The player cannot connect to the network.

- Check the network connection (page 13) and the network settings (page 23).

The PC cannot connect to the Internet after [Wi-Fi Protected Setup™ (WPS)] is performed.

- The wireless settings of the router may change automatically if you use the Wi-Fi Protected Setup function before adjusting the settings of the router. In this case, change the wireless settings of your PC accordingly.

You cannot connect the player to the wireless LAN router.

- Check if the wireless LAN router is on.
- Move the player and the wireless LAN router closer to each other.
- Move the player away from devices that use a 2.4 GHz frequency band such as a microwave, Bluetooth or digital cordless device, or turn off such devices.

The desired wireless router do not appear in the wireless network list.

- Press RETURN to return to the previous screen, and try wireless setup again. If the desired wireless router is still not detected, select [New connection registration] to perform [Manual registration].

The message [A new software version is available. Please go to the "Setup" section of the menu and select "Software Update" to perform the update.] appears on the screen when turning the player on.

- See [Software Update] (page 19) to update the player to a newer software version.

Control for HDMI (BRAVIA Sync)

The [Control for HDMI] function does not work (BRAVIA Sync).

- Check that your TV is connected via the HDMI OUT 1 jack.
- Check that [Control for HDMI] in [HDMI Settings] is set to [On] (page 22).
- If you change the HDMI connection, turn the player off and on again.
- If power failure occurs, set [Control for HDMI] in [HDMI Settings] to [Off], then set [Control for HDMI] in [HDMI Settings] to [On] (page 22).
- Check the following and refer to the instruction manual supplied with the component.
 - the connected component is compatible with the [Control for HDMI] function.
 - the connected component's setting for the [Control for HDMI] function is correct.
- When you connect the player to a TV through an AV amplifier (receiver),
 - if the AV amplifier (receiver) is not compatible with the [Control for HDMI] function, you may be unable to control the TV from the player.
 - if you change the HDMI connection, disconnect and reconnect the AC power cord (mains lead), or a power failure occurs, try the following:
 - ① Switch the input selector of the AV amplifier (receiver) so that the picture from the player appears on the TV screen.
 - ② Set [Control for HDMI] in [HDMI Settings] to [Off], then set [Control for HDMI] in [HDMI Settings] to [On] (page 22). Refer to the instruction manual supplied with the AV amplifier (receiver).

The System Power-Off function does not work (BRAVIA Sync).

- Check that [Control for HDMI] and [Linked to TV-off] in [HDMI Settings] are set to [On] and [Valid] (page 22).

Others

Playback does not start from the beginning of content.

- Press OPTIONS, and select [Play from start].

Playback does not start from the resume point where you last stopped playing.

- The resume point may be cleared from memory depending on the disc when
 - you open the disc tray.
 - you disconnect the USB device.
 - you play other content.
 - you turn off the player.

Message Code 1 [Playback stopped. The content being played is protected by Cinavia and is not authorized for playback on this device. For more information, see <http://www.cinavia.com>. Message Code 1.] appears on the screen when playing a disc.

- The audio track of the video that you are playing contains a Cinavia code indicating it was intended for presentation using professional equipment only and is not authorised for playback by consumers (page 33).

The disc tray does not open and you cannot remove the disc even after you press ▲ (open/close).

- While the player is turned on, press ■ (stop), HOME, and then TOP MENU button on the remote to unlock the tray and disable the Child Lock (page 10).
- Try the following: ① Turn the player off, and disconnect the AC power cord (mains lead). ② Reconnect the AC power cord (mains lead) while pressing down ▲ (open/close) on the player. ③ Keep pressing down ▲ (open/close) on the player until the tray opens. ④ Remove the disc.
- The disc tray will not respond during network streaming (e.g. Netflix) even after you press ▲ (open/close).

The message [[EJECT] Key is currently unavailable.] appears on the screen after ▲ (open/close) is pressed.

- Contact your nearest Sony dealer or local authorised Sony service facility.

The player does not respond to any button.

- Moisture has condensed inside the player (page 4).

Playable discs

Blu-ray Disc ^{*1}	Ultra HD Blu-ray, BD-ROM, BD-R ^{*2} /BD-RE ^{*2}
DVD ^{*3}	DVD-ROM, DVD-R/ DVD-RW, DVD+R/DVD+RW
CD ^{*3}	CD-DA (Music CD), CD-ROM, CD-R/CD-RW, Super Audio CD

^{*1} Since the Blu-ray Disc specifications are new and evolving, some discs may not be playable depending on the disc type and the version. The audio output differs depending on the source, connected output jack, and selected audio settings.

^{*2} BD-RE: Ver.2.1, BD-R: Ver.1.1, 1.2, 1.3 including organic pigment type BD-R (LTH type). The BD-Rs recorded on a PC cannot be played if postscripts are recordable.

^{*3} A CD or DVD disc will not play if it has not been correctly finalised or the disc is not in Mastered disc format. For more information, refer to the instruction manual supplied with the recording device.

Discs that cannot be played

- BDs with cartridge
- BDXLs
- DVD-RAMs
- HD DVDs
- PHOTO CDs
- Data part of CD-Extras
- Super VCDs
- DVD AUDIO
- Audio material side on DualDiscs

Note on Discs

This product is designed to playback discs that conform to the Compact Disc (CD) standard. DualDiscs and some of the music discs encoded with copyright protection technologies do not conform to the Compact Disc (CD) standard, therefore, these discs may not be playable by this product.

Note on playback operations of Ultra HD Blu-ray/BD/DVD

Some playback operations of Ultra HD Blu-ray/BD/DVD may be intentionally set by software producers. Since this player plays Ultra HD Blu-ray/BD/DVD according to the disc contents the software producers designed, some playback features may not be available.

Note about double-layer Ultra HD Blu-ray/BD/ DVD and triple-layer Ultra HD Blu-ray

The playback pictures and sound may be momentarily interrupted when the layers switch.

Region code (BD/DVD VIDEO only)

Your player has a region code printed on the rear of the unit and will only play BD/DVD VIDEO labeled with identical region codes or



Playable types of files

Video

Codec	Container	Extension	With Audio
MPEG-1 Video ^{*1}	PS	.mpg, .mpeg	Dolby Digital, DTS, LPCM, MPEG
	MKV	.mkv	Dolby Digital, LPCM, AAC, MP3, Vorbis
MPEG-2 Video ^{*2}	PS ^{*3}	.mpg, .mpeg	Dolby Digital, DTS, LPCM, MPEG
	TS ^{*4}	.m2ts, .mts	Dolby Digital, DTS, LPCM, MPEG, AAC
Xvid	MKV ^{*1}	.mkv	Dolby Digital, LPCM, AAC, MP3, Vorbis
	AVI	.avi	Dolby Digital, LPCM, WMA9, MP3
MPEG4/AVC/ H.264 ^{*5}	MKV ^{*1}	.mkv	Dolby Digital, LPCM, AAC, MP3, Vorbis
	MP4 ^{*1}	.mp4, .m4v	AAC
	TS ^{*1}	.m2ts, .mts	Dolby Digital, DTS, LPCM, MPEG, AAC
	Quick Time	.mov	Dolby Digital, LPCM, AAC, MP3
	FLV	.flv, .f4v	LPCM, AAC, MP3
VC1 ^{*1}	3gpp/3gpp2	.3gp, .3g2, .3gpp, .3gp2	AAC
	TS	.m2ts, .mts	Dolby Digital, DTS, LPCM, MPEG, AAC
WMV9 ^{*1*6}	MKV	.mkv	Dolby Digital, LPCM, AAC, MP3, Vorbis
	ASF	.wmv, .asf	WMA9, WMA 10 Pro
Motion JPEG	MKV	.mkv	Dolby Digital, LPCM, AAC, MP3, Vorbis
	Quick Time	.mov	Dolby Digital, LPCM, AAC, MP3
HEVC/H.265	AVI	.avi	Dolby Digital, LPCM, AAC, MP3
	MKV	.mkv	Dolby Digital, LPCM, AAC, MP3, Vorbis
	MP4	.mp4, .m4v	AAC
VP6	TS	.m2ts, .mts	Dolby Digital, DTS, LPCM, MPEG, AAC
	FLV	.flv	MP3
VP8/VP9	Webm	.webm	Vorbis
	MKV	.mkv	Dolby Digital, LPCM, AAC, MP3, Vorbis

Format

AVCHD (Ver.2.0)^{*1*7*8*9}

Music

Codec	Extension
MP3 (MPEG-1 Audio Layer III) ^{*10}	.mp3
AAC/HE-AAC ^{*1*10}	.m4a, .aac
WMA9 Standard ^{*1}	.wma
WMA 10 Pro ^{*11}	.wma
LPCM ^{*10}	.wav
FLAC ^{*1}	.flac, .fla
Dolby Digital ^{*10*12}	.ac3
DSF ^{*1}	.dsf
DSDIFF ^{*1*13}	.dff
AIFF ^{*1}	.aiff, .aif
ALAC ^{*1}	.m4a
Vorbis	.ogg
Monkey's Audio	.ape

Photo

Format	Extension
JPEG	.jpeg, .jpg, .jpe
PNG	.png ^{*14}
GIF	.gif ^{*14}
MPO	.mpo ^{*12*15}
BMP	.bmp ^{*12*16}
WEBP	.webp ^{*12}

^{*1} The player may not play this file format on a Home Network server.

^{*2} The player can only play standard definition video on a Home Network server.

^{*3} The player does not play DTS format files on a Home Network server.

^{*4} The player can only play Dolby Digital format files on a Home Network server.

^{*5} The player can support AVC up to Level 4.1.

^{*6} The player can support WMV9 up to Advance Profile.

^{*7} The player can support frame rate up to 60 fps.

^{*8} The player plays AVCHD format files that are recorded on a digital video camera, etc. The AVCHD format disc will not play if it has not been correctly finalised.

^{*9} The player can play AVCHD 3D format.

^{*10} The player can play ".mka" files. This file cannot be played on a Home Network server.

^{*11} The player does not play coded file such as Lossless.

^{*12} The player does not play this file format on a Home Network server.

^{*13} The player does not play DST encoded files.

^{*14} The player does not play animated PNG or animated GIF files.

^{*15} For MPO files other than 3D, the key image or the first image is displayed.

^{*16} The player does not support 16bit BMP files.



- Some files may not play depending on the file format, file encoding, recording condition, or Home Network server condition.
- Some files edited on a PC may not play.
- Some files may not be able to perform fast forward or fast reverse function.
- The player does not play coded files such as DRM.
- The player can recognise the following files or folders in BDs, DVDs, CDs and USB devices:
 - up to folders in the 9th layer, including the root folder.
 - up to 500 files/folders in a single layer.
- The player can recognise the following files or folders stored in the Home Network server:
 - up to folders in the 19th layer.
 - up to 999 files/folders in a single layer.
- The player can support frame rate:
 - up to 60 fps for AVCHD (MPEG4/AVC) only.
 - up to 30 fps for other video codecs.
- The player can support video bit rate up to 40 Mbps.
- Some USB devices may not work with this player.
- The player can recognise Mass Storage Class (MSC) devices (such as flash memory or an HDD), Still Image Capture Device (SICD) class devices and 101 keyboard.
- The player may not play high bit rate video and audio files on DATA CDs smoothly. It is recommended to play such files using DATA DVDs or DATA BDs.

Specifications

Specifications and design are subject to change without notice.

System

Laser	Semiconductor laser
--------------	---------------------

Inputs and outputs

Jack name	Jack type/Output level/Load impedance
DIGITAL OUT (COAXIAL)	Phono jack /0.5 Vp-p/75 ohms
HDMI OUT 1*/2	HDMI 19-pin standard connector * Only HDMI OUT 1 supports video output.
LAN (100)	100BASE-TX Terminal
USB	USB jack Type A (For connecting a USB memory, memory card reader, digital still camera, and digital video camera)* * Do not use for power charging purposes.
DC IN	12 V DC, 1.25 A

Wireless

Wireless LAN standard	Protocol IEEE802.11b/g/n
Frequency range / Output Power	2,400 - 2,483.5 MHz / < 20.0 dBm
Modulation	DSSS and OFDM

General

Power requirements	12 V DC with AC adaptor Rating: Input 220 V - 240 V AC, 50/60 Hz
Power consumption (when using AC adaptor)	15 W
Network standby	Less than 2 W (all wired/wireless network ports ON)
Dimensions (approx.)	320 mm × 217 mm × 45 mm (width × depth × height) incl. projecting parts
Mass (approx.)	1.4 kg
Operating temperature	5 °C to 35 °C
Operating humidity	25 % to 80 %

Copyrights and Trademarks

- Oracle and Java are registered trademarks of Oracle and/or its affiliates. Other names may be trademarks of their respective owners.
- Manufactured under license from Dolby Laboratories. Dolby, Dolby Audio and the double-D symbol are trademarks of Dolby Laboratories.
- For DTS patents, see <http://patents.dts.com>. Manufactured under license from DTS Licensing Limited. DTS, DTS-HD, the Symbol, & DTS and the Symbol together are registered trademarks, and DTS-HD Master Audio is a trademark of DTS, Inc. © DTS, Inc. All Rights Reserved.
- The terms HDMI[®], HDMI High-Definition Multimedia Interface, Premium High Speed HDMI Cable, and the HDMI Logo are trademarks or registered trademarks of HDMI Licensing, LLC in the United States and other countries.
- Blu-ray Disc[™], Blu-ray[™], BD-Live[™], BONUSVIEW[™], Ultra HD Blu-ray[™] word marks and logos are trademarks of the Blu-ray Disc Association.
- Blu-ray 3D[™] and Blu-ray 3D[™] logo are trademarks of the Blu-ray Disc Association.
- "DVD Logo" is a trademark of DVD Format/Logo Licensing Corporation.
- "DVD+RW", "DVD-RW", "DVD+R", "DVD-R", "DVD VIDEO", "Super Audio CD" and "CD" logos are trademarks.
- "BRAVIA" is a trademark of Sony Corporation.
- MPEG Layer-3 audio coding technology and patents licensed from Fraunhofer IIS and Thomson.
- This product incorporates proprietary technology under license from Verance Corporation and is protected by U.S. Patent 7,369,677 and other U.S. and worldwide patents issued and pending as well as copyright and trade secret protection for certain aspects of such technology. Cinavia is a trademark of Verance Corporation. Copyright 2004-2010 Verance Corporation. All rights reserved by Verance. Reverse engineering or disassembly is prohibited.
- Windows Media is either a registered trademark or trademark of Microsoft Corporation in the United States and/or other countries.

This product is protected by certain intellectual property rights of Microsoft Corporation. Use or distribution of such technology outside of this product is prohibited without a license from Microsoft or an authorized Microsoft subsidiary.

Content owners use Microsoft PlayReady[™] content access technology to protect their intellectual property, including copyrighted content. This device uses PlayReady technology to access PlayReady-protected content and/or WMDRM-protected content. If the device fails to properly enforce restrictions on content usage, content owners may require Microsoft to revoke the device's ability to consume PlayReady-protected content. Revocation should not affect unprotected content or content protected by other content access technologies. Content owners may require you to upgrade PlayReady to access their content. If you decline an upgrade, you will not be able to access content that requires the upgrade.
- Wi-Fi[®], Wi-Fi Protected Access[®], Wi-Fi Alliance[®] and Miracast[®] are registered trademarks of Wi-Fi Alliance.
- Wi-Fi CERTIFIED[™], WPA[™], WPA2[™], Wi-Fi Protected Setup[™] and Wi-Fi CERTIFIED Miracast[™] are trademarks of Wi-Fi Alliance.
- The Wi-Fi CERTIFIED Logo is a certification mark of Wi-Fi Alliance.
- The Wi-Fi Protected Setup Identifier Mark is a certification mark of the Wi-Fi Alliance.
- This product incorporates Spotify software which is subject to 3rd party licenses found here*: <https://developer.spotify.com/esdk-third-party-licenses/> Spotify and Spotify logos are trademarks of the Spotify Group.*
- * This function may not be available in some countries/regions.
- Opera[®] Devices SDK. Copyright 1995-2016 Opera TV AS. All rights reserved.
- All other trademarks are trademarks of their respective owners.
- Other system and product names are generally trademarks or registered trademarks of the manufacturers. [™] and [®] marks are not indicated in this document.



Copy Protection

Please be advised of the advanced content protection systems used in Ultra HD Blu-ray™, Blu-ray Disc™ and DVD media. These systems, called AACS (Advanced Access Content System) and CSS (Content Scramble System), may contain some restrictions on playback, analog output, and other similar features. The operation of this product and the restrictions placed may vary depending on the date of purchase, as the governing board of the AACS may adopt or change its restriction rules after the time of purchase.

Cinavia Notice

This product uses Cinavia technology to limit the use of unauthorized copies of some commercially-produced film and videos and their soundtracks. When a prohibited use of an unauthorized copy is detected, a message will be displayed and playback or copying will be interrupted.

More information about Cinavia technology is provided at the Cinavia Online Consumer Information Center at <http://www.cinavia.com>. To request additional information about Cinavia by mail, send a postcard with your mailing address to: Cinavia Consumer Information Center, P.O. Box 86851, San Diego, CA, 92138, USA.

Software License Information

For EULA (End User License Agreement), please refer to END USER LICENSE AGREEMENT sheet supplied with this player.

USING YOUR PRODUCT INDICATES YOUR ACCEPTANCE OF THIS AGREEMENT.

For details of the other software licenses, please select [Setup] and refer to [Software License Information] in [System Settings].

This product contains software that is subject to the GNU General Public License ("GPL") or GNU Lesser General Public License ("LGPL"). These licenses establish that customers have the right to acquire, modify, and redistribute the source code of said software in accordance with the terms of the GPL or the LGPL.

The source code for the software used in this product is subject to the GPL and LGPL, and is available on the Web. To download, please visit the following website:

<http://oss.sony.net/Products/Linux>

Please note that Sony cannot respond to any inquiries regarding the content of this source code.

Privacy Policy

For Privacy Policy, please refer to [Privacy Policy] in the option menu on each network service icon.

Network services, content and software of this product may be subject to individual terms and conditions and changed, interrupted or discontinued at any time and may require fees, registration and credit card information.

Language code list

For details, see [BD/DVD Viewing Settings] (page 21).

The language spellings conform to the ISO 639: 1988 (E/F) standard.

Code	Language	Code	Language
1027	Afar	1028	Abkhazian
1032	Afrikaans	1039	Amharic
1044	Arabic	1045	Assamese
1051	Aymara	1052	Azerbaijani
1053	Bashkir	1057	Byelorussian
1059	Bulgarian	1060	Bihari
1061	Bislama	1066	Bengali
1067	Tibetan	1070	Breton
1079	Catalan	1093	Corsican
1097	Czech	1103	Welsh
1105	Danish	1109	German
1130	Bhutani; Dzongkha	1142	Greek
1144	English	1145	Esperanto
1149	Spanish	1150	Estonian
1151	Basque	1157	Persian
1165	Finnish	1166	Fiji
1171	Faroese	1174	French
1181	Frisian	1183	Irish
1186	Scots Gaelic	1194	Galician
1196	Guarani	1203	Gujarati
1209	Hausa	1217	Hindi
1226	Croatian	1229	Hungarian
1233	Armenian	1235	Interlingua
1239	Interlingue	1245	Inupiak
1248	Indonesian	1253	Icelandic
1254	Italian	1257	Hebrew
1261	Japanese	1269	Yiddish
1283	Javanese	1287	Georgian
1297	Kazakh	1298	Greenlandic; Kalaallisut
1299	Cambodian; Khmer	1300	Kannada
1301	Korean	1305	Kashmiri
1307	Kurdish	1311	Kirghiz

Code	Language	Code	Language
1313	Latin	1326	Lingala
1327	Laothian; Lao	1332	Lithuanian
1334	Latvian	1345	Malagasy
1347	Maori	1349	Macedonian
1350	Malayalam	1352	Mongolian
1353	Moldavian	1356	Marathi
1357	Malay	1358	Maltese; Maltese
1363	Burmese	1365	Nauru
1369	Nepali	1376	Dutch
1379	Norwegian	1393	Occitan
1403	Oromo	1408	Oriya
1417	Punjabi; Panjabi	1428	Polish
1435	Pashto; Pushto	1436	Portuguese
1463	Quechua	1481	Rhaeto- Romance
1482	Kirundi; Rundi	1483	Romanian
1489	Russian	1491	Kinyarwanda
1495	Sanskrit	1498	Sindhi
1501	Sangho; Sango	1502	Serbo-Croatian
1503	Singhalese; Sinhalese	1505	Slovak
1506	Slovenian	1507	Samoan
1508	Shona	1509	Somali
1511	Albanian	1512	Serbian
1513	Siswati; Swati	1514	Sesotho; Sotho southern
1515	Sundanese	1516	Swedish
1517	Swahili	1521	Tamil
1525	Telugu	1527	Tajik
1528	Thai	1529	Tigrinya
1531	Turkmen	1532	Tagalog
1534	Setswana; Tswana	1535	Tonga; Tonga islands
1538	Turkish	1539	Tsonga
1540	Tatar	1543	Twí
1557	Ukrainian	1564	Urdu
1572	Uzbek	1581	Vietnamese
1587	Volapük	1613	Wolof
1632	Xhosa	1665	Yoruba
1684	Chinese	1697	Zulu
1703	Not specified		

Parental control/area code

For details, see [Parental Control Area Code] (page 22).

Code	Area		
2044	Argentina	2047	Australia
2046	Austria	2057	Belgium
2070	Brazil	2090	Chile
2092	China	2093	Colombia
2115	Denmark	2165	Finland
2174	France	2109	Germany
2200	Greece	2219	Hong Kong
2248	India	2238	Indonesia
2239	Ireland	2254	Italy
2276	Japan	2304	Korea
2333	Luxembourg	2363	Malaysia
2362	Mexico	2376	Netherlands
2390	New Zealand	2379	Norway
2427	Pakistan	2424	Philippines
2428	Poland	2436	Portugal
2489	Russia	2501	Singapore
2149	Spain	2499	Sweden
2086	Switzerland	2543	Taiwan
2528	Thailand	2184	United Kingdom
2586	Vietnam		

For Your Convenience

Before Inquiries:

Please confirm the following details:

- Investigate with "Troubleshooting" (page 25) to help remedy the problem.
- Turn the player off and disconnect the AC power cord (mains lead). Wait for a while, then reconnect the AC power cord (mains lead) again.

Record the serial number (S/N) in the space provided below. Provide this number to your Sony dealer to get quicker action whenever you call them regarding this product.
S/N _____



To find out useful hints, tips and information about Sony products and services please visit: www.sony.eu/myproducts/

4-698-407-11(1)

<http://www.sony.net/>

© 2017 Sony Corporation

Printed in Malaysia

