

Midland G7 Pro Midland G7E Pro

► User manual



DUAL BAND PMR/LPD TRANSCEIVER |



Index

Introduction	1
Content of the package	2
Coverage (referred to PMR frequency band)	3
Main functions	4
Above all....Safety!	5
Warnings	5
Identifying the parts	6
LCD Display	6
Transceiver	8
Preparing the transceiver	10
Recharging the NIMH batteries (4 x AA)	10
Recharging the NIMH battery pack PB-ATL/G7 800 mAh	11
Recharging the Li-Ion battery pack 'PB-PRO' (optional)	11
Memory effect of rechargeable batteries	12
Installing and removing the belt clip	12
Installing/removing the battery pack	13
Removal	13
Installation	13
Basic operation	14
Turning on/off	14
Volume control	14
Transmission and reception	14

MON button (Monitor)	15
Scanning all channels	15
Display backlight	15
5.7 Keypad lock	15
Power Save	16
MENU button	17
Channel selection	17
CTCSS/DCS tones selection	17
Choosing high or low transmission power (PMR band)	18
VOX function	18
Vibra-Call function	19
ROGER BEEP (End transmission tone)	19
CALL function	19
Dual Watch function	20
Keypad beep	20
7. Troubleshooting and radio reset	21
Reset	21
Technical specifications	22
Transmitter	22
Receiver	22

Introduction

Thanks for purchasing **Midland G7 Pro**!

Midland G7/G7E Pro combines the most advanced technology in radio communication with extreme reliability. This brand new transceiver, with its eye-catching design and sturdy mechanical frame is the ideal solution for both the professionals who need to stay in touch with colleagues (construction sites, buildings, hotels, trade fairs, shows) or with leisure users that just want to keep up with friends and family.

Extremely robust and easy to use, **G7/G7E Pro** is ideal for use in any activity; it operates on both PMR446 and LPD bands (see the chart 'Restrictions on use').

The Midland **G7/G7E Pro** incorporates all the functions that you would expect to see on the latest and most advanced transceivers and guarantees maximum efficiency.

The **improved audio** and **Side Tone** are the most important features of this new radio; other key functions include an LCD backlit display, a Vibrating call alert feature for use in high-noise areas and an auto power save function which reduces battery consumption by up to 50%. All of the features on this outstanding radio are easily accessible thanks to the centrally mounted controls.

Content of the package

Depending on the version, the content changes.

Single packing:

- 1 transceiver with belt clip
- 1 wall adaptor
- 4 AA rechargeable batteries 1800mAh
- quick guide

Twin packing:

- 2 transceivers with belt clip
- 1 wall adaptor
- 1 double desktop charger
- 2 battery packs 800mAh
- quick guide

It is available the optional Li-Ion battery pack 1200mAh mod. 'PB-PRO'.

If any item is missing or damaged, contact immediately your supplier.

Coverage (referred to PMR frequency band)

The maximum range depends on terrain condition and is obtained during use in an open space.

The only limitation to maximum possible range are environmental factors such as blockage caused by trees, buildings, or other obstructions. Inside a car or a metallic constructions, the range can be reduced. Normally the coverage in the city, with buildings or other obstructions is about 1 or 2 Km. In open space but with obstructions like trees, leaves or houses the maximum possible range is about 4-6 Km. In open space, without obstructions and in sight, like for example in mountain, the coverage can be more than 12 Km.

Main functions

- **G7 Pro:** Dual Band LPD/PMR transceiver
- **G7E Pro:** PMR446 transceiver
- Dual PTT for high/low power transmission
- Side Tone: end transmission noise muffler
- New audio level
- VIBRACALL function
- LCD display with backlight
- Low battery indicator
- Auto power save: automatic current economy circuit
- 38 CTCSS and 104 DCS tones in TX and RX
- CALL button with 5 tones selectable
- Automatic squelch adjustment
- Buttons for the channel selection
- SCAN function
- Keypad lock
- Hi/low power selection (PMR band)
- Roger Beep on/off
- VOX for hands-free communications
- Dual Watch
- 2 Pin jack for ext. mike / ext. speaker / battery recharge

 *The manufacturer, with its effort to constantly improve product quality, reserves the right to change characteristics and features without prior notice.*

Above all....Safety!

Warnings

- ! *Do not open the radio for any reason! The radio's precision mechanics and electronics require experience and specialized equipment; for the same reason, the radio should under no circumstances be realigned as it has already been calibrated for maximum performance. Unauthorized opening of the transceiver will void the warranty.*
- ! *Do not use detergents, alcohol, solvents, or abrasives to clean the equipment. Just use a soft, clean cloth. If the radio is very dirty, slightly dampen the cloth with a mixture of water and a neutral soap.*



BATTERIES

- ! *Do not try to charge alkaline batteries or non rechargeable batteries. Make sure that when you charge the radio, only rechargeable NI-MH batteries should be contained in the battery compartment! It is very dangerous attempting to recharge other types of batteries (for example alkaline or manganese batteries). Batteries which are not suitable to be recharged may leak, explode or even burn and cause damage!*
- ! *Using a different battery charger other than the one specified can cause damage to your device or may even cause explosions and personal injuries.*
- ! *Do not throw batteries into fire or place them near heat as this may cause explosions or personal injuries. Dispose of the batteries according to procedures set out by local regulations.*
- ! *Do not mix old and new batteries or batteries of different types or batteries which have been used in different manners.*

Identifying the parts

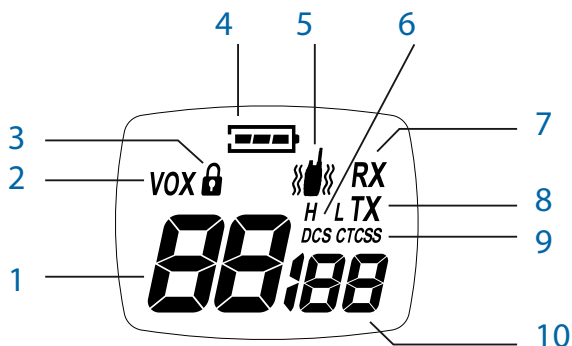
LCD Display



1. **Selected channel** (P1-P8: PMR446 /1-69:LPD)
2. **VOX** - Function activated
3.  - Keypad lock activated
4.  - Battery status indicator
5.  - Vibra-Call function activated
6. **H/L** - Indicates the high / low power selection in transmission (only in PMR band)
7. **RX** - Radio in rx mode (busy channel)
8. **TX** - Radio in transmission (PTT pressed)
9. **DCS/CTCSS** - Type of sub-audio tone selected
10. **Code of the selected CTCSS or DCS tone**
(CTCSS: 1-38; DCS: 1-104)

Transceiver

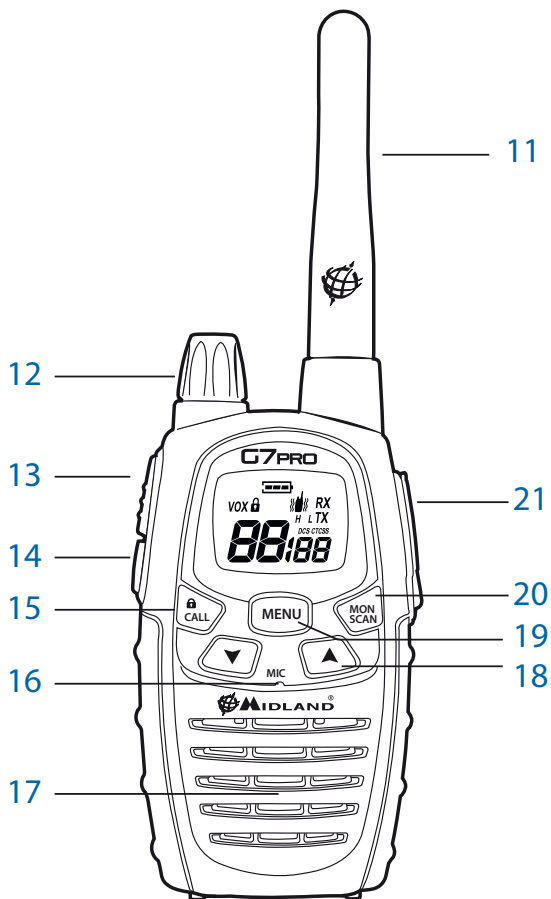

11. Antenna

12. **OFF/VOLUME knob** - To switch on/off the radio and to adjust the volume.
13. **PTT** - Press to transmit.
14. **BOOST** - Press to transmit in high power.
15. **CALL/🔒** – to send a call to the selected channel. If you keep it pressed for about 3 seconds, the keypad lock is activated.
16. **MIC** - Built-in microphone
17. **Built-in Speaker.**
18. **▲ ▼ controls** - To change the settings in the **MENU**.
19. **MENU** - Press this control to enter the radios **MENU**
20. **MON/SCAN** - Press this button once to activate SCAN. Keep it pressed for about 2 seconds to activate the Monitor function, that temporarily cuts off the squelch (for weak signals)
21. **SPK | MIC/CHG** (under the protective cover) - To connect to external audio devices such as microphones, headphones, chargers, etc

Preparing the transceiver

The radio can be recharged with different type of batteries: here below the possibilities.

Note: *To optimize the recharge process, we suggest you switch off the radio to recharge it.*

Recharging the NIMH batteries (4 x AA)

Place your transceiver into the cradle of the desktop charger or connect the MW904 wall adaptor to the proper jack of the radio.

This type of batteries is recharged with a constant current, either you use a desktop charger or MW904; therefore the recharge time depends from the recharge status and from the batteries capacity.

There's no evidence when the recharge is finished, therefore we suggest you detach the wall adaptor from the radio or remove **G7 Pro** from the desktop charger cradle once the recharge is complete.

Here below some information about the recharge time (indicative) for some batteries of different capacity:

Battery capacity mAh	Approx. recharge time (hours)
1200	5
1800	7
2100	8

 *When the radio is in the charger cradle, the processor makes a sort of checking on the battery; the led on the charger will light up for 10 seconds, then will turn off and the recharge will start.*

 *The battery icon on the radio's display will be blinking for all the recharging process, as well as the red led will be lighting up on the desktop charger.*

Recharging the NIMH battery pack PB-ATL/G7 800 mAh

Place your transceiver into the cradle of the desktop charger or connect the MW904 wall adaptor to the proper jack of the radio.

This type of batteries is recharged with a constant current, either you use a desktop charger or MW904, therefore a complete recharge takes about 5 hours.

There's no evidence when the recharge is finished, therefore we suggest you detach the wall adaptor from the radio or remove **G7 Pro** from the desktop charger cradle after 5 hours.

 *When the radio is in the charger cradle, the processor makes a sort of checking on the battery; the led on the charger will light up for 10 seconds, then will turn off and the recharge will start; the battery icon on the radio's display will be blinking for all the recharging process, as well as the red led will be lighting up on the desktop charger.*

Recharging the Li-Ion battery pack 'PB-PRO' (optional)

Place your transceiver into the cradle of the desktop charger or connect the MW904 wall adaptor to the proper jack of the radio.

The recharge of the Li-Ion battery pack is managed by a radio processor and the battery status can be checked by the icon on the display and by the led on the desktop charger

- The recharge status is indicated by the led on the desktop charger and by the battery icon blinking on the display of the radio;
- When the recharge is complete, the led will turn off and the battery icon on the display will be full of bars and fix.

 *When the radio is in the charger cradle, the processor makes a sort of checking on the battery status: in this step, the led on the desktop charger will light up for 10 seconds, then will turn off and the recharge will start.*

 *To optimize the recharge of the Li-Ion battery pack, in the final phase the processor will alternately charge and pause for almost one minute (the led will turn off).*

 *If the radio is placed in the desktop charger switched on, when the recharge is complete the led will blink.*

Memory effect of rechargeable batteries

Rechargeable NiMH (Nickel-Metal-Hydrate) batteries are affected by what is known as the “memory effect”. This phenomenon is associated with a drastic reduction of battery autonomy and is triggered if the batteries are regularly charged before being fully discharged and/or are not completely recharged. To avoid the memory effect:

- When possible, recharge the batteries only when they are completely discharged (until the device turns itself off during normal use)
- Do not disconnect the battery charger before the time indicated for a full battery charge.

 *The memory effect should not be confused with the normal battery life, which is 300-400 cycles of charge/discharge on average. It is completely normal for operating duty to decrease when the batteries have reached the end of their life; at this point, you will need to substitute the batteries.*

Installing and removing the belt clip

With the belt clip you can easily attach the transceiver to your belt. The clip however, must be removed in order to install or change the batteries. To remove the belt clip follow the indication of picture 1. To fix the clip back to the device slot it in the guides at the back of the transceiver until it clicks into place.

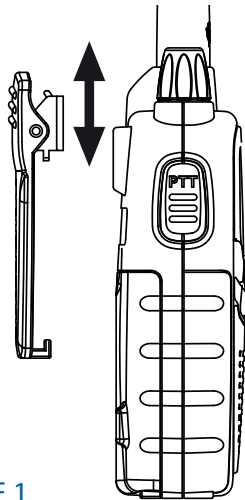

PICTURE 1

Installing/removing the battery pack

Removal

1. Remove the belt clip as explained in paragraph "Installing and removing the belt clip";
2. Open the battery compartment as shown in picture 2;
3. Remove the battery pack;
4. Close the battery cover and fix the belt clip.

Installation

1. Remove the belt clip as explained in paragraph "Installing and removing the belt clip";
2. Insert the battery pack into the battery compartment;
3. Close the battery cover and fix the belt clip.

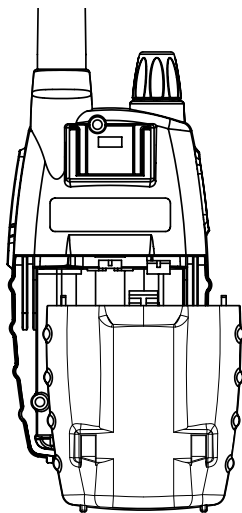

PICTURE 2

Basic operation

Turning on/off

To turn on the transceiver, turn the **VOLUME** knob clockwise until you hear it clicks: the LCD display will light up and do an Auto-Test. Subsequently you will hear 2 beeps of different tones.

To turn off the transceiver, turn the knob counter-clockwise until you hear another click.

Volume control

Turn the knob **VOLUME** to about half way and adjust it to a comfortable level as soon as you receive a signal. If you do not receive a signal you can use the button **MON/SCAN** described in par. "MON button".

Transmission and reception

The **PTT** key has a dual function, as it is composed by 2 parts: a bigger PTT and a red one, smaller, identified with "**boost**".

When you press the bigger PTT the transceiver transmits with high or low power (depending on the setting of the **MENU: H or L**); while the smaller PTT (Boost) always transmits with high power.

To transmit:

1. Make sure that no one else is currently talking on the selected channel;
2. Keep button **PTT** firmly pressed: **TX** will appear on the display;
3. Before you start talking wait for a fraction of a second then speak normally, in the direction of the microphone, and hold the device at a distance of about 5 cm.
4. When you have finished, release the **PTT**: **TX** will disappear from the display;
5. When the radio is in reception mode (**PTT** not pressed) you will automatically receive any communication (**RX** displayed).

 *During transmission and reception try, as far as possible, to keep the antenna in vertical position and to avoid obstacles towards the direction of the other party.*

MON button (Monitor)

The **Monitor** button is for temporarily excluding (opening) the squelch, in order to listen to signals that are too weak to keep the squelch permanently opened. By excluding the squelch you will avoid listening to the communication “chopped” by the squelch. In order to activate the Monitor function, so as to listen to all traffic on the selected channel, keep pressed the **MON/SCAN** button for about 2 seconds. Keep pressed the button **MON/SCAN** for about 2 seconds to disable this function.

Scanning all channels

Midland G7/G7E Pro can automatically search for signals throughout the PMR/LPD bands by scanning, i.e. selecting the channels in rapid sequence. When a signal is detected, the scanning pauses on that channel and you can transmit by pushing **PTT**. If you press **PTT** during scanning you can transmit on the channel from which the scanning started. The scroll buttons **▲/▼** allow you to change the direction of scanning (from lower channels to higher ones or vice versa) and therefore to skip communications which are of no interest.

Press briefly the button **MON/SCAN** to start scanning.

If you want to stop it, press again **MON/SCAN**. Your transceiver will go back to the channel from which the scanning originally started.

Display backlight

If there is insufficient light to read the display you can press the **MENU** button to switch the display back light on for about 5 seconds.

 *Switching the backlight on the display adds an additional drain on the batteries. Try to make a moderate use of this.*

5.7 Keypad lock

Keep pressed **CALL/🔒** for about 5 seconds and **🔒** will be displayed as confirmation. Only **PTT** and **CALL/🔒** remain active. To disable this function, keep pressed again **CALL/🔒** for 5 seconds approx.

Power Save

The battery power saving feature enables a reduction in the consumption of up to 50%; power saving comes on automatically when the transceiver does not receive any signal for more than 5 seconds. When the batteries are discharged, **bt LO** appears on the display: replace the batteries or recharge the battery pack.

MENU button

Channel selection

Press once the **MENU** button. The number of the channel will start flashing on the display. Press the scroll buttons ▲/▼ to scroll up or down the PMR and then LPD channels till you select the desired channel.

Press the **PTT** button to confirm, or wait for 10 seconds.

 Refer to the table of frequencies.

CTCSS/DCS tones selection

Midland **G7/G7E Pro** can receive in two modes:

- a. **Open traffic:** in this case you will hear any communication transmitted on the selected channel;
- b. **Group mode CTCSS/DCS:** CTCSS/DCS tones are access keys that allow you to receive only messages coming from parties using the same channel and code. The speaker will remain muted until the correct tone is received.

To activate 1 of 38 different CTCSS/104 DCS tones in RX and TX

1. Turn on the radio.
2. Select the desired channel.
3. Press twice **MENU** until the Display shows **oF**.
4. By pushing the ▲/▼ controls the display will show **CTCSS** (*ct* blinking) or **DCS** (*dc* blinking); press **MENU** to enter the CTCSS or DCS tones. Now select the desired tone with the ▲/▼ keys.
5. To confirm the setting, press the **PTT** key or wait for approximately 10 seconds.

Choosing high or low transmission power (PMR band)

Batteries are drained more quickly during transmission. In order to extend the battery life you can select the low power when transmitting over short distances.

Procedure:

1. Press the **MENU** button for 3 times and *Pr H* will be displayed.
2. Select *L* using the scroll buttons ▲/▼.
3. Press **PTT** to confirm, or wait for 10 seconds.

If you want to transmit a longer distance repeat the above procedure to select the high power. At step 2 select *H*. When the batteries are in good conditions, high power is 500mW, whereas low power is 10mW.

 *A low battery level during transmission will reduce the performance of your device.*

VOX function

Midland **G7/G7E Pro** enables hands free conversations through VOX function. You can enable VOX function with or without accessories. **G7 Pro** is supplied with 3 different VOX selections:

- **VOX standard** (*Vo* on the display)
- **VOX baby-sitting** (*Vb* on the display)
- **VOX Bike** (*Vc* for motorbikers)

All these options can be selected on two levels as follows:

1. To activate VOX function press the **MENU** button 4 times in the PMR band and **VOX** will appear on the display.
2. Use the scroll ▲/▼ buttons to select the desired setting:
OFF: Disabled;
3. **Vo1/Vo2 - Vb1/Vb2 - Vc1/Vc2**
where 1 means 1st Level (low sensitivity) and 2 means 2nd Level (high sensitivity);
4. Press **PTT** to confirm or wait for 10 seconds.

To disable the VOX function follow the instructions above and select option **oF**.

Vibra-Call function

Midland **G7/G7E Pro** is equipped with the “Vibra-Call” feature, which provides a vibration for incoming calls.

To activate it, follow these steps:

1. In the PMR band, press the **MENU** button for 10 times, until the display shows ;
2. Use the **▲/▼** buttons to disable or enable this feature (**on**: enables, **oF**:disables);
3. Push **PTT** to confirm or wait for 10 seconds.

 *Everytime Midland G7/G7E Pro receives a call, it will vibrate.*

 *When the Vibracall function is enabled, the call tone won't be heard.*

ROGER BEEP (End transmission tone)

Every time you end transmission (PTT released), Midland **G7/G7E Pro** gives out a sound that indicates to the other party that s/he can start talking. This function is factory disabled.

To activate it:

1. Press six times the **MENU** button in the PMR band until the display shows “**rb oF**”;
2. Using the scroll buttons **▲/▼** select “**on**” and “**rb on**” will be displayed;
3. To confirm the roger beep activation, press **PTT** button or wait for 10 seconds.

CALL function

Midland **G7/G7E Pro** can send 5 different call tones. To send this audio signal to other users, press the **CALL/🔒** key.

To select the call tones:

1. Push the **MENU** button 7 times in the PMR band, until the display shows “**CA 1**”.

2. By pushing ▲/▼ you will hear the 10 pre-set melodies.
3. Confirm by pressing the **PTT** key or wait for 10 seconds.

Now, each time your Midland **G7/G7E Pro** sends out a tone call, it will beep with the selected melody.

 *If the Vibracall function is activated (See par. "Vibra-call function"), the call tone won't be heard.*

Dual Watch function

This function allows the monitoring of 2 channels of your choice.

Procedure:

1. Select one of the 2 channels you want to monitor.
 2. Press 9 times the **MENU** button in the PMR band until the display shows "**TX oF RX**".
 3. With the ▲/▼ button select the second channel to monitor.
 4. Push the **PTT** key or wait for 10 seconds for confirmation.
- To disable the function, press the **MON/SCAN** button.

Keypad beep

To deactivate the keypad beep, follow these steps:

1. Press for 8 times the **MENU** button in the PMR band, until "**bP on**" is displayed.
 2. Use the ▲/▼ buttons until the display shows "**bP of**".
 3. Confirm by pushing the **PTT** or wait for 10 seconds.
- Now you won't hear any beep at the pressure of any button.

7. Troubleshooting and radio reset

Your Midland **G7/G7E Pro** is designed to provide you with years of optimal performance. If for some reason problems arise, refer to this chapter before contacting a service centre in your region.

Reset

If your transceiver experiences a logical malfunction (improper symbols on the display, blocking of functions, etc.), it may not be experiencing a true failure, but rather a problem caused by external factors. For example, it may have an incorrect setting brought on by a noise or spikes in the electrical system during battery recharging. In such cases, you can reset the transceiver to its factory-programmed settings, by resetting all parameters:

1. Turn off the transceiver
2. Keep pressed the ▲ button and turn on the radio at the same time. All the functions will be reset ex-factory.

 *Before you go ahead with the reset, we recommend that you take note of all the setting you have carried out as they will be deleted.*

Technical specifications

Channels	1~8 PMR, 1~69 LPD
Frequency range	446.00625 ÷ 446.09375MHz (PMR) 433.075 ÷ 434.775MHz (LPD)
Channel spacing	12.5 KHz (PMR); 25 KHz (LPD)
Power supply	6+/- 10% Vdc
Temperature	from -20° to +55°C
Dimensions (w/o batteries)	58 (L)x 122 (H)x34 (D) mm
Weight (w/o batteries)	123gr
Duty cycle	TX 5%, RX 5%, stand-by 90%
Category	B
Transmitter	
Output power	10 or 500 mW (Selectable)
Modulation	FM
Spurious rejection	within European legal terms
Receiver	
Sensitivity @ 12dB Sinad	0,35µV
Adjacent channel rejection	70dB
Audio output power	300mW @ 10% THD
Jack for ext.mike and recharge	stereo 2,5 mm
Jack for ext. speaker	mono 3.5 mm
Maximum transmission time in an hour	6 minutes, equivalent to a duty cycle of 10%

Specifications are subject to change without notice.

WARNING: Direct plug-in ac/dc power supply must be used for disconnecting the transceiver from the mains; the desktop charger must be positioned close to the unit and easily accessible.

CTE International herewith declares that the product complies with the essential requirements of EC Directive 99/05/EC.



All articles displaying this symbol on the body, packaging or instruction manual of same, must not be thrown away into normal disposal bins but brought to specialised waste disposal centres. Here, the various materials will be divided by characteristics and recycles, thus making an important contribution to environmental protection.

Prodotto o importato da:

CTE INTERNATIONAL s.r.l.

Via. R.Sevardi 7- 42124 Reggio Emilia Italia

www.cte.it - www.midlandeurope.com

L'uso di questo apparato può essere soggetto a restrizioni nazionali (per l'uso in Italia in modalità PMR446, è richiesta una dichiarazione di possesso come da D.L. 259 del 01/08/03 art. 99 comma 3; All. 25 art. 36 e successivi aggiornamenti) . Prima dell'uso leggere attentamente le istruzioni. Se il prodotto contiene batterie: non gettare nel fuoco, non disperdere nell'ambiente dopo l'uso, usare gli appositi contenitori per la raccolta.

Produced or imported by:

CTE INTERNATIONAL s.r.l.

Via. R.Sevardi 7 42124 Mancasale Reggio Emilia Italy

Imported by:

ALAN - NEVADA UK

Unit 1 Fitzherbert Spur Farlington Portsmouth Hants.

P06 1TT - United Kingdom

www.nevada.co.uk

The use of this transceiver can be subject to national restrictions. Read the instructions carefully before installation and use. If the product contains batteries: do not throw the battery into fire. To disperse after use, throw into the appropriate containers.

Importado por:

ALAN COMMUNICATIONS, SA

C/Cobalt, 48 - 08940 Cornellà de Llobregat (Barcelona - España)

Tel: +34 902 384878 Fax: +34 933 779155

www.midland.es

El uso de este equipo puede estar sujeto a la obtención de la correspondiente autorización administrativa. Lea atentamente las instrucciones antes de usar el equipo. si el producto contiene pilas o baterías no las tire al fuego ni las disperse en el ambiente después de su uso, utilice los contenedores apropiados para su reciclaje.

Vertrieb durch:

ALAN ELECTRONICS GmbH

Daimlerstraße 1K - D-63303 Dreieich Deutschland

www.alan-electronics.de

Die Benutzung dieses Handfunkgerätes ist von den landesspezifischen Bestimmungen abhängig. Vor Benutzung Bedienungsanleitung beachten. Bei Verwendung von Batterien beachten Sie bitte die Umweltbestimmungen. Batterien niemals ins offene Feuer werfen, und nur in dafür vorgesehene Sammelbehälter entsorgen.

WWW.MIDLANDEUROPE.COM |



 **MIDLAND**[®]