

# GR

RICOH

## GR II

# Operating Manual

The serial number may be found on the bottom of the camera.

### Before You Begin

**Read this section before use.**

It covers the names of the parts and how to prepare the camera for use.

### First Steps

**Read this section before using your camera for the first time.**

It covers the basic operations for using your camera for the first time, including how to turn on the camera, take pictures, and play back images.

### Advanced Operations

**Read this section when you want to learn more about the different camera functions.**

It covers all shooting and playback functions and describes how to customize the camera settings and use it with a computer.

## Checking the Contents of the Package

Before using your digital camera, confirm that the package contains the items listed below.

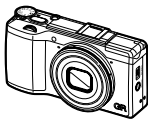

**GR II**



**Hot shoe cover**  
(attached to camera)



**Rechargeable battery**  
(DB-65)



**USB power adapter**  
(AC-U1)



**Power plug**

- **USB cable**
- **Hand strap**
- **CD-ROM**
- **Operating Manual (this manual)**

## User Registration

Thank you for purchasing a RICOH IMAGING product.

In order to provide you with the best customer support and service experience for the product you have purchased, we ask you to complete the user registration.

Visit the following Web site to complete the user registration.

**<http://www.ricoh-imaging.com/registration/>**

Registered users will be notified by e-mail about important customer support information, such as firmware version updates, etc.

# Introduction

This Operating Manual provides information on how to use the shooting and playback functions of this camera and related precautions.

Thoroughly read this Operating Manual to make the best use of the functions available with this camera. Be sure to keep this Operating Manual for future reference.

RICOH IMAGING COMPANY, LTD.

Safety precautions	Read all safety precautions thoroughly to ensure safe use.
Test shots	Take test shots to ensure that the camera is working properly before taking photos on important occasions.
Copyright	Reproduction or alteration of copyrighted documents, magazines, and other materials, other than for personal, home, or other similarly limited purposes, without the consent of the copyright holder, is prohibited.
Exemption from liability	RICOH IMAGING COMPANY assumes no liability for failure to record or display images as a result of product malfunction.
Radio interference	Operating this camera in the vicinity of other electronic equipment may adversely affect both the camera and the other device. Interference is particularly likely if the camera is used in close proximity to a radio/TV receiver. In such case, take the following measures. <ul style="list-style-type: none"><li>• Keep the camera as far away as possible from the radio/TV receiver.</li><li>• Reorient the antenna of the radio/TV receiver.</li><li>• Use a different wall outlet.</li></ul>

This publication may not be reproduced in whole or in part without RICOH IMAGING COMPANY's express written permission.

© RICOH IMAGING COMPANY, LTD. 2015

RICOH IMAGING COMPANY reserves the right to change the contents of this manual at any time without prior notice.

Every effort has been made to ensure the accuracy of the information in this manual. Should you nevertheless notice any errors or omissions, we would be grateful if you would notify us at the address listed on the back cover of this manual.

## About the Wireless LAN Function

- Do not use the camera in a place where electrical products, AV/OA devices, and so on generate magnetic fields and electromagnetic waves.
- If the camera is affected by magnetic fields and electromagnetic waves, it may not be able to communicate.
- If the camera is used near a TV or a radio, poor reception or TV screen glitch may occur.
- If there are multiple wireless LAN access points near the camera and the same channel is used, search operation may not be executed correctly.
- The security of your data stored, sent or received is your own responsibility.

In the frequency band used by the camera, along with industrial, scientific, and medical devices such as a microwave oven, premises radio stations (wireless stations requiring license) and specified low power radio stations (wireless stations not requiring license) for mobile object identification used in factory production lines, etc., and amateur radio stations (wireless stations requiring license) are operated.

1. Before using the camera, confirm that premises radio stations and specified low power radio stations for mobile object identification and amateur radio stations are not operated in the vicinity.
2. In the event that the camera causes harmful radio wave interference to premises radio stations for mobile object identification, immediately change the frequency being used to avoid interference.
3. If you have other troubles such that the camera causes harmful radio wave interference to specified low power radio stations for mobile object identification or to amateur radio stations, contact your nearest service center.

This camera conforms to the technical standards under the Radio Law and Telecommunications Business Law and the certification of conformance to technical standards can be displayed on the picture display.



### Displaying the Certification Marks

The certification marks of conformance to wireless technical standards under the Radio Law and Telecommunications Business Law can be displayed from [Certification Marks] of the [Setup] menu. Refer to "Setting from the Menu" (p.133) for how to use the menus.

## Trademarks

- Microsoft, Windows, Windows 7<sup>®</sup>, and Windows 8<sup>®</sup> are registered trademarks of Microsoft Corporation in the United States of America and other countries.
  - Macintosh, Mac OS, and OS X are registered trademarks of Apple Inc. in the United States of America and other countries.
  - IOS is a trademark or registered trademark of Cisco in the U.S. and other countries and is used under license.
  - Adobe, the Adobe logo, and Adobe Reader are trademarks or registered trademarks of Adobe Systems Incorporated in the United States of America and other countries.
  - This product incorporates DNG technology with the permission of Adobe Systems Incorporated. The DNG logo is a trademark or registered trademark of Adobe Systems Incorporated in the United States of America and other countries.
  - The SDXC logo is a trademark of SD-3C, LLC.
  - HDMI, the HDMI logo, and High-Definition Multimedia Interface are trademarks or registered trademarks of HDMI licensing, LLC in the United States and/or other countries.
  - SILKYPIX is a registered trademark of Ichikawa Soft Laboratory.
  - Google, Google Play, and Android are trademarks or registered trademarks of Google Inc.
  - Wi-Fi is a registered trademark of Wi-Fi Alliance.
  - The N-Mark is a trademark or registered trademark of NFC Forum, Inc. in the United States and in other countries.
  - Facebook is a registered trademark of Facebook, Inc.
  - Twitter is a registered trademark of Twitter, Inc.
  - Tumblr is a registered trademark of Tumblr, Inc.
- All other trade names mentioned in this manual are the property of their respective owners.

### AVC Patent Portfolio License

This product is licensed under the AVC Patent Portfolio License for the personal use of a consumer or other uses in which it does not receive remuneration to (i) encode video in compliance with the AVC standard ("AVC video") and/or (ii) decode AVC video that was encoded by a consumer engaged in a personal activity and/or was obtained from a video provider licensed to provide AVC video.

No license is granted or shall be implied for any other use.

Additional information may be obtained from MPEG LA, L.L.C.

See <http://www.mpegla.com>.

### **Announcement on the Use of BSD-Licensed Software**

This product includes software licensed under the BSD License. BSD license is a form of license which permits the redistribution of the software provided that it is clearly stated that use is unwarranted, and a copyright notice and a list of licensing conditions are provided. The following contents are displayed based on the abovementioned licensing conditions and are not for the purpose of restricting your use of the product, etc.

Tera Term

Copyright (c) T.Teranishi.

Copyright (c) TeraTerm Project.

All rights reserved.

Redistribution and use in source and binary forms, with or without modification, are permitted provided that the following conditions are met:



1. Redistributions of source code must retain the above copyright notice, this list of conditions and the following disclaimer.
2. Redistributions in binary form must reproduce the above copyright notice, this list of conditions and the following disclaimer in the documentation and/or other materials provided with the distribution.
3. The name of the author may not be used to endorse or promote products derived from this software without specific prior written permission.

THIS SOFTWARE IS PROVIDED BY THE AUTHOR "AS IS" AND ANY EXPRESS OR IMPLIED WARRANTIES, INCLUDING, BUT NOT LIMITED TO, THE IMPLIED WARRANTIES OF MERCHANTABILITY AND FITNESS FOR A PARTICULAR PURPOSE ARE DISCLAIMED. IN NO EVENT SHALL THE AUTHOR BE LIABLE FOR ANY DIRECT, INDIRECT, INCIDENTAL, SPECIAL, EXEMPLARY, OR CONSEQUENTIAL DAMAGES (INCLUDING, BUT NOT LIMITED TO, PROCUREMENT OF SUBSTITUTE GOODS OR SERVICES; LOSS OF USE, DATA, OR PROFITS; OR BUSINESS INTERRUPTION) HOWEVER CAUSED AND ON ANY THEORY OF LIABILITY, WHETHER IN CONTRACT, STRICT LIABILITY, OR TORT (INCLUDING NEGLIGENCE OR OTHERWISE) ARISING IN ANY WAY OUT OF THE USE OF THIS SOFTWARE, EVEN IF ADVISED OF THE POSSIBILITY OF SUCH DAMAGE.

## Safety Precautions

### Warning Symbols

Various symbols are used throughout this Operating Manual and on the product to prevent physical harm to you or other people and damage to property. The symbols and their meanings are explained below.

	<b>Danger</b>	This symbol indicates matters that may lead to imminent risk of death or serious injury if ignored or incorrectly handled.
	<b>Warning</b>	This symbol indicates matters that may lead to death or serious injury if ignored or incorrectly handled.
	<b>Caution</b>	This symbol indicates matters that may lead to injury or physical damage if ignored or incorrectly handled.

### Meaning of Symbols



The  symbol alerts you to actions that must be performed.



The  symbol alerts you to prohibited actions.

The  symbol may be combined with other symbols to indicate that a specific action is prohibited.

• Example:

: Do not touch : Do not disassemble

Observe the following precautions to ensure safe use of this camera.



### Danger



• Do not attempt to disassemble, repair or alter the equipment yourself. The high-voltage circuitry in the equipment poses significant electrical hazard.



• Do not attempt to disassemble, alter or directly solder the battery.



• Do not put the battery in a fire, attempt to heat it, use it in a high temperature environment such as next to a fire or inside a car, or abandon it. Do not put it into water or the sea or allow it to get wet.



• Do not attempt to pierce, hit, compress, drop, or subject the battery to any other severe impact or force.



• Do not use a battery that is significantly damaged or deformed.



• Do not connect the positive (+) and negative (-) poles of the battery with a wire or other metallic item. Also, do not carry or store together with metal objects such as ballpoint pens and necklaces.



- Do not charge the battery with a charger from another manufacturer. Also, do not use the battery with any camera except the cameras compatible with the DB-65.



- Discontinue use immediately in the event of abnormalities such as smoke, unusual odors, or excessive heat being emitted. Contact your nearest dealer or service center for repair.



- If the battery fluid leaks and gets into your eyes, immediately wash your eyes thoroughly with tap water or other clean water without rubbing, and seek medical attention immediately.



## Warning



- Turn off the power immediately in the event of abnormalities such as smoke or unusual odors being emitted. Remove the battery as soon as possible, being careful to avoid electric shocks or burns. If you are drawing power from a household electrical outlet, be sure to unplug the power plug from the outlet to avoid fire or electrical hazards. Contact the nearest service center at your earliest convenience. Discontinue use of the equipment immediately if it is malfunctioning.



- Turn off the power immediately if any metallic object, water, liquid or other foreign object gets into the camera. Remove the battery and memory card as soon as possible, being careful to avoid electric shocks or burns. If you are drawing power from a household electrical outlet, be sure to unplug the power plug from the outlet to avoid fire or electrical hazards. Contact the nearest service center at your earliest convenience. Discontinue use of the equipment immediately if it is malfunctioning.



- Avoid any contact with the liquid crystal inside the picture display, should the monitor be damaged. Follow the appropriate emergency measures below.
  - SKIN: If any of the liquid crystal gets on your skin, wipe it off and rinse the affected area thoroughly with water, then wash well with soap.
  - EYES: If it gets in your eyes, wash your eyes with clean water for at least 15 minutes and seek medical advice immediately.
  - INGESTION: If any of the liquid crystal is ingested, rinse the mouth out thoroughly with water. Have the person drink a large amount of water and induce vomiting. Seek medical assistance immediately.



- Follow these precautions to prevent the battery from leaking, overheating, igniting or exploding.
  - Do not use a battery other than those specifically recommended for the equipment.
  - Do not carry or store together with metal objects such as ballpoint pens, necklaces, coins, hairpins, etc.
  - Do not put the battery into a microwave or high pressure container.
  - If leakage of battery fluid or a strange odor, color change, etc. is noticed during use or during charging, remove the battery from the camera or battery charger immediately and keep it away from fire.



- Please observe the following in order to prevent fire, electrical shock or cracking of the battery while charging.
- Use only the indicated power supply voltage. Also avoid the use of multi-socket adapters and extension cords.
- Do not damage, bundle or alter power cords. Also, do not place heavy objects on, stretch or bend power cords.
- Do not connect or disconnect the power plug with wet hands. Always grip the plug section when disconnecting a power plug.
- Do not cover the equipment while charging.



- Keep the battery and memory card used in this equipment out of the reach of children to prevent accidental ingestion. Consumption is harmful to human beings. If swallowed, seek medical assistance immediately.



- Keep the equipment out of the reach of children.



- Do not touch the internal components of the equipment if they become exposed as a result of being dropped or damaged. The high-voltage circuitry in the equipment could lead to an electric shock. Remove the battery as soon as possible, being careful to avoid electric shocks or burns. Take the equipment to your nearest dealer or service center if it is damaged.



- Do not use the equipment in wet areas as this could result in fire or electric shock.



- Do not use the equipment near flammable gases, gasoline, benzene, thinner or similar substances to avoid the risk of explosion, fire or burns.
- Do not use the equipment in locations where usage is restricted or prohibited as this may lead to disasters or accidents.



- Wipe off any dust that accumulates on the power plug as this may lead to fire.



- To avoid the risk of fire, electric shock or product malfunction, do not use the battery charger with commercially available electronic transformers when traveling abroad.



- To avoid the risk of fire or electric shock, use only the indicated power supply voltage.



- Do not damage, bundle or alter power cords. Also, to avoid damaging power cords and the risk of fire or electric shock, do not place heavy objects on, stretch or bend power cords.





- Do not connect or disconnect the power plug with wet hands. Both operations pose the risk of electric shock.



- Always grip the plug section when disconnecting a power plug. Do not pull the power cord. This can damage the power cord and result in fire or electric shock.



- If any metallic object, water, liquid or other foreign object gets into the camera, immediately remove the power plug from the outlet and contact a service center for repair. Failure to observe these precautions could result in fire or electric shock.
- If an abnormality such as an unusual sound or smoke is emitted from the equipment, immediately remove the power plug from the outlet and contact your nearest dealer or service center for repair. Discontinue use of the equipment immediately if it is malfunctioning.



- Do not attempt to disassemble the equipment yourself. The high-voltage circuitry in the equipment could lead to an electric shock.



- Do not use in bathrooms or similar areas, as this can result in fire or electric shock.



- Do not touch the power plug during a lightning storm. This poses a risk of electric shock.



- Keep the battery out of the reach of children.



- If the battery does not finish charging after the prescribed charging time, discontinue charging.



- Do not put the battery into a microwave or high pressure container.



- If the battery leaks or emits an unusual odor, immediately move it away from any sources of fire.



## Caution



- Contact with fluid leaking from a battery can lead to burns. If part of your body comes in contact with a damaged battery, rinse the area with water immediately. (Do not use soap.)  
If a battery starts to leak, remove it immediately from the equipment and wipe the battery chamber thoroughly before replacing it with a new battery.



- Plug the power plug securely into the electrical outlets. Loose plug poses a fire hazard.



- Do not allow the camera to get wet. In addition, do not operate it with wet hands. Both situations pose the risk of electric shock.



- Do not fire the flash at drivers of vehicles, as this may cause the driver to lose control and result in a traffic accident.



- Remove the power plug from the outlets before cleaning the equipment.
- Remove the power plug from the outlets when not in use.



- Do not cover equipment while charging, as this can result in fire.
- Do not short the terminals or metal contacts on the power cords, as this can result in fire.
- Do not use the equipment in wet areas or areas subject to oil smoke as this could result in fire or electric shock.

**Safety Precautions  
for Accessories**

When using optional products, carefully read the instructions provided with the product before using that product.

# Contents

Introduction.....	1
Contents.....	9
<b>Before You Begin</b>	<b>13</b>
Parts of the Camera.....	14
Using the Dials and Lever .....	16
Picture Display .....	18
Getting Ready .....	23
<b>First Steps</b>	<b>31</b>
Basic Shooting .....	32
Shooting with Auto Settings .....	32
Self-timer.....	34
Checking the Camera Level and Tilt.....	36
Playing Back Images .....	38
Using the Menu.....	39
<b>Advanced Operations</b>	<b>41</b>
<b>1 Various Shooting Functions</b>	<b>42</b>
Shooting with a Set Exposure .....	42
Using Exposure Compensation.....	48
Setting the ISO Sensitivity .....	49
Dynamic Range Compensation .....	51
Selecting a Metering Method.....	52
Using the ND Filter .....	53
Setting a Picture Format.....	54
Setting the Focus.....	56
Selecting a Focusing Method .....	56
Shooting Close-ups (Macro Mode).....	59
Using the AF Button .....	60
Setting Focus Assist and AE/AF Target .....	63
Shooting with a Single Press of the Shutter Release Button (Full Press Snap) .....	66

Setting the White Balance .....	67
Setting the Color Temperature.....	70
Setting the White Balance Manually .....	70
Shooting Continuously.....	71
Shooting Continuously .....	72
Shooting Continuously with Different Settings (Auto Bracket) .....	73
Shooting While Merging Images Together (Multiple Exposure Shooting).....	74
Shooting Automatically at Set Intervals (Interval Shooting).....	76
Recording Star Trails (Interval Composite).....	77
Using the Flash .....	79
Setting the Flash Mode.....	79
Adjusting the Intensity of the Flash .....	81
Setting the Flash Intensity for Manual Flash .....	82
Setting the Timing for Firing the Flash .....	82
Taking Images with Unique Atmosphere .....	83
Effect.....	83
Image Settings .....	88
Changing the Ambient Brightness .....	89
Other Shooting Functions.....	90
Adding the Date to Still Images .....	90
Recording Movies.....	91
Setting the Movie Format.....	91
Recording Movies .....	92
Playing Back Movies.....	93
Clipping Movies.....	94

## **2 Playback Functions 95**

---

Displaying Images in Thumbnail View .....	95
Displaying Images in a Slide Show.....	95
Displaying Images in Enlarged View.....	96
Organizing Files.....	97
Deleting Files .....	97
Setting Protection.....	99
Copying the Images and Movies in the Internal Memory to a Memory Card .....	101

Correcting and Processing Images.....	102
Reducing the Size of Images.....	102
Trimming Images.....	102
Correcting Skewed Images.....	103
Correcting Brightness and Contrast (Level Compensation).....	104
Correcting the White Balance.....	106
Correcting Color Moire.....	107
Developing RAW Images.....	108
Viewing Images with an AV Device.....	110
Setting DPOF.....	112
Setting DPOF for Multiple Still Images.....	113

### **3 Changing Camera Settings** **114**

---

Customizing the Camera.....	114
Registering Shooting Settings (My Settings).....	114
Shooting Images in My Settings Mode.....	117
Editing "My Settings".....	118
Registering Functions to the ADJ. Lever.....	120
Registering Functions to the Fn1, Fn2, and Effect Buttons.....	122
Changing Other Settings.....	124
Adjusting the Brightness of the Picture Display.....	124
Setting the Information Displayed in Shooting Mode.....	125
Setting the Operation Sounds.....	126
Setting the File and Folder Names.....	126
Setting the Copyright Notice.....	129
Checking the Firmware Version.....	129

### **4 Making Use of Images** **130**

---

Using Images on a Computer.....	130
Saving Images to a Computer.....	131
Operating the Camera with a Communication Device.....	132
Enabling the Wi-Fi Function.....	132
Operating the Camera with a Communication Device.....	136
Changing the Settings.....	143

<b>5</b>	<b>Menus</b>	<b>145</b>
	[Shooting] Menu .....	145
	[Playback] Menu .....	149
	[Key Custom Options] Menu .....	150
	[Setup] Menu .....	152
<b>6</b>	<b>Appendices</b>	<b>155</b>
	Trouble Shooting .....	155
	Error Messages .....	155
	Camera Troubleshooting .....	156
	Specifications .....	161
	Storage Capacity .....	164
	Optional Accessories .....	166
	Conversion Lens, Hood, and Adapter .....	166
	External Flash .....	167
	Using the Camera Abroad .....	170
	Precautions for Use .....	171
	Camera Care and Storage .....	173
	Warranty Policy .....	174
	NOTICES .....	175
	Index .....	178

# Before You Begin

**This section covers the names of the parts and how to prepare the camera for use.**

Parts of the Camera.....	14
Using the Dials and Lever .....	16
Picture Display .....	18
Getting Ready .....	23

## Parts of the Camera

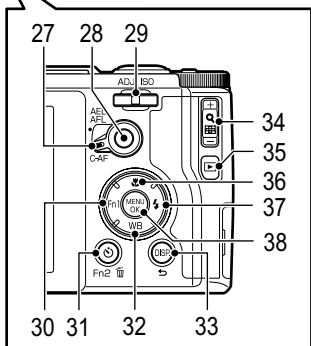
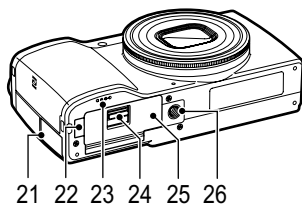
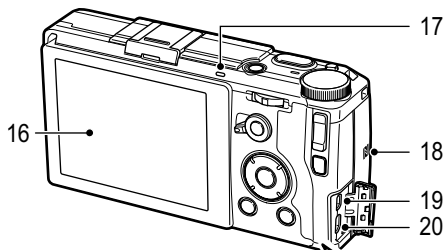
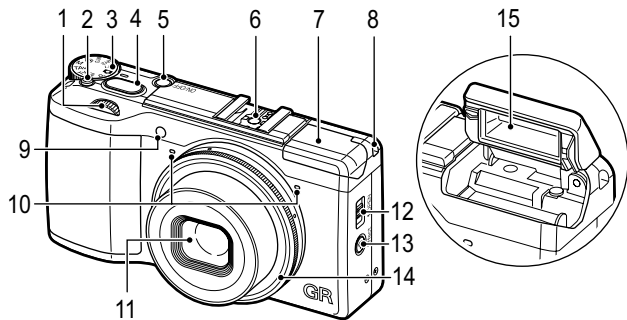



1	Up-down dial.....	17	21	Terminal cover.....	25, 110, 131
2	Mode dial lock release button .....	16	22	DC power cable cover	
3	Mode dial.....	16	23	Speaker	
4	Shutter release button .....	32	24	Release lever .....	23
5	POWER button .....	27	25	Battery/card cover.....	23
6	Hot shoe.....	167	26	Tripod screw hole	
7	Flash cover .....	32	27	AF function switching lever.....	60
8	Strap eyelet		28	AF button .....	60
9	AF auxiliary light.....	34, 152	29	ADJ. lever .....	17, 120
10	Microphone		30	Fn1 (function 1)/◀ button.....	122
11	Lens		31	⌚ (self-timer)/Fn2 (function 2)/ ⌫ (delete) button .....	34, 97, 122
12	⚡ (flash) OPEN switch .....	32	32	WB (white balance)/▼ button.....	67
13	📶 (Wi-Fi)/Effect button .....	47, 122, 134	33	DISP./↶ button .....	21, 36, 125
14	Ring cap.....	166	34	+/- (Q/⊞) button.....	95, 96
15	Flash .....	32	35	▶ (playback) button .....	38
16	Picture display.....	18	36	📷 (macro)/▲ button.....	59
17	Autofocus/flash lamp.....	33	37	⚡ (flash)/▶ button.....	80
18	NFC mark .....	134	38	MENU/OK button.....	39
19	USB/AV OUT terminal.....	25, 110, 131			
20	HDMI micro output terminal (Type D) .....	110			

## Using the Dials and Lever

### Mode Dial

You can change the shooting mode with the mode dial.

While pressing the mode dial lock release button (①), turn the mode dial (②).

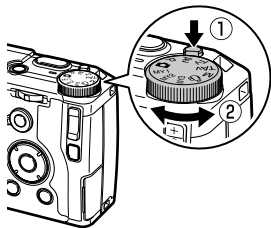

#### **Av: Aperture priority mode (p.42)**

Allows you to manually set the aperture value. The camera adjusts the shutter speed automatically.

#### **P: Program shift mode (p.42)**

Allows you to choose from combinations of aperture value and shutter speed.

#### **☑: Auto shooting mode (p.32)**

Automatically sets the optimal aperture value and shutter speed depending on the subject.

#### **MY1/MY2/MY3: My Settings mode (p.117)**

Allows you to shoot with the settings registered to [Reg. My Settings].

#### **Tv: Shutter priority mode (p.42)**

Allows you to manually set the shutter speed. The camera adjusts the aperture value automatically.

#### **TAv: Shutter/ Aperture priority mode (p.42)**

Allows you to manually set the shutter speed and aperture value. The camera adjusts the ISO sensitivity automatically.

#### **M: Manual exposure mode (p.42)**

Allows you to manually set the aperture value and shutter speed.

#### **🎥: Movie mode (p.91)**

Allows you to record movies.

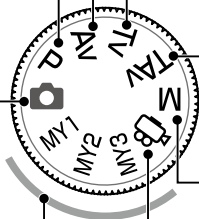

## Up-down Dial and ADJ. Lever

Use the up-down dial and ADJ. lever in place of the ▲▼◀▶ buttons and to set the exposure. (p.43)

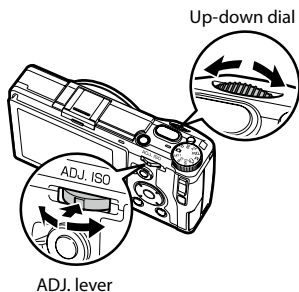

	Operation	Description
Up-down dial	Turn left or right	Used in place of the ▲▼ buttons. Changes the aperture value and shutter speed.
ADJ. lever	Press left or right	Used in place of the ◀▶ buttons. Changes the aperture value, shutter speed, and ISO sensitivity.
	Push in the middle	Calls assigned function. (p.121)



### Note

- You can switch the functions of the up-down dial and ADJ. lever. (p.44)

# Picture Display

## Shooting Screen

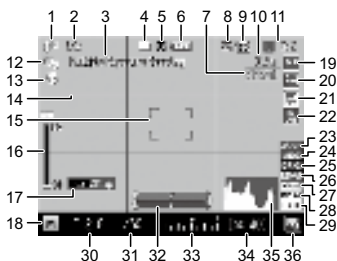

Still image mode



Movie mode

1	Flash mode.....	79
2	Flash compensation/Manual flash amount .....	81, 82
3	Multiple exposure shooting/Interval shoot- ing/Interval composite.....	74, 76, 77
4	Continuous mode.....	72
5	Wi-Fi connection.....	20
6	Battery level.....	20
7	Auto exposure lock/Autofocus lock.....	60
8	Number of storable images.....	164
9	Data storage location.....	24
10	Snap focus distance.....	58
11	Format and size/Aspect ratio/Frame rate .....	54, 91
12	Self-timer.....	34
13	Macro mode.....	59
14	Grid guide.....	21
15	Focus frame.....	33
16	Focus bar/Depth of field.....	58
17	Operation guide	
18	Shooting mode.....	42
19	Focus mode.....	56

20	Exposure metering.....	52
21	Image setting/Effect.....	83
22	Auto bracket.....	73
23	Crop.....	55
24	Conversion lens.....	166
25	Ambient brightness [Original].....	89
26	ND filter.....	53
27	Noise reduction.....	50
28	Dynamic range compensation.....	51
29	Date imprint.....	90
30	Aperture value.....	43
31	Shutter speed.....	43
32	Level indicator.....	21, 36
33	Exposure indicator/Exposure compensation .....	43, 48
34	ISO sensitivity.....	49
35	Histogram.....	21
36	White balance mode.....	67
37	Recording time/Remaining recording time .....	164
38	Recording indicator.....	92
39	Reduce fluorescent flicker.....	91

**Note**

- The maximum number that can be displayed for the number of storable images is "9999".

**Playback Screen**

Still image mode

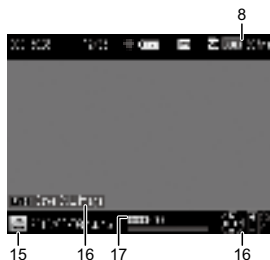



Movie mode

1	Folder number-File number .....	126
2	Current file/Total files .....	
3	Wi-Fi connection .....	20
4	Battery level.....	20
5	Protect .....	99
6	DPOF print indicator .....	112
7	Data source .....	24
8	Format and size/Aspect ratio/Frame rate .....	54, 91



9	Date of shooting .....	
10	Highlight alert .....	22
11	Aperture value .....	43
12	ISO sensitivity.....	49
13	Shutter speed.....	43
14	Exposure compensation .....	48
15	File type .....	
16	Operation guide .....	
17	Total time:Elapsed time.....	93

## Battery Level Indicator

Icon	Status
	Battery is fully charged.
	Battery is partially charged. Recharging the battery is recommended.
	Low battery. Recharge the battery.

## Wi-Fi Connection

When using a Wi-Fi connection (p.132), the connection status is displayed in the shooting and playback mode screens.

Icon	Status
	Not connected
	Connected

## Changing the Screen Display

### Shooting Mode

Select from the following displays in shooting mode.

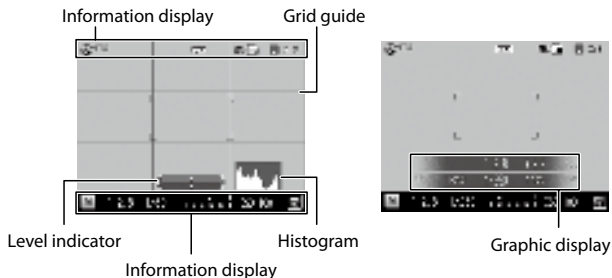

#### Note

- You can specify the information displayed each time the DISP. button is pressed in [DISP. Button Display Setting] of the [Setup] menu. (p.125)
- When [Information Display Mode] of the [Setup] menu is set to [On], information is displayed on the picture display in the following cases even when the picture display is turned off. After the information is displayed and no operations are performed for several seconds, or when the shutter release button is pressed halfway, the information display disappears.
  - When the Fn1 button, button, button, or Effect button is pressed
  - When the mode dial or up-down dial is turned
  - When the ADJ. lever is pressed left or right
  - When the OPEN switch is pressed to raise the flash, or the flash cover is closed

## Playback Mode

Normal indicator display



Detailed information display

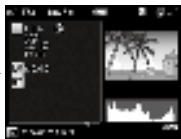

No indicator display



Highlight alert



### Note

- The pages of the detailed information display can be switched using the ▲▼ buttons.
- When [Highlight Alert] of the [Setup] menu is set to [On], the white saturation areas of the image flash in black in the highlight alert. When this is set to [Off] (default setting), the highlight alert is not shown.



### Caution

- The detailed information display and highlight alert are not shown when recording movies.
- The highlight alert is not shown when connected with an HDMI cable.



## Getting Ready

Prepare the camera for use.

### Inserting the Battery and a Memory Card

Be sure that the camera is off before inserting or removing the battery and memory card.

SD memory cards, SDHC memory cards, and SDXC memory cards can be used with this camera. "Memory card" refers to these memory cards in this manual.

- 1** Slide the release lever on the bottom of the camera toward OPEN to open the battery/card cover.

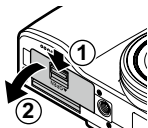

- 2** Make sure that the memory card is facing the right way and then push the card all the way in until it clicks.

To remove it, press in the memory card and then release your hand.

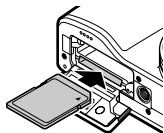

- 3** Insert the battery.

Use the battery to press the latch and insert the battery all the way into the battery compartment.

To remove the battery, press and slide the latch.

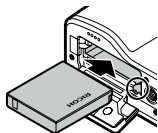

- 4** Close the battery/card cover and slide the release lever in the opposite direction of OPEN to lock it in place.

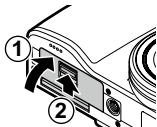

## Data Storage Location

Images taken and movies recorded with this camera are saved in the internal memory or a memory card. When a memory card is not inserted in the camera, images and movies are saved in the internal memory.



### Caution

- Images and movies are not saved in the internal memory when a memory card is inserted, even if the memory card is full.
- If the number of files stored in a memory card exceeds 10000, files with a small folder/file number cannot be played back.



### Note

- You can copy all data stored in the internal memory to a memory card. (p.101)
- The storage capacity varies depending on the memory card. (p.164)
- When using a new memory card or a memory card used with another device, be sure to format the memory card with this camera. Format memory cards in [Format [Card]] of the [Setup] menu.

## Charging the Battery

Charge the rechargeable battery (DB-65) using the included USB cable and USB power adapter (AC-U1) with the included power plug before use.

- 1** Insert the power plug to the USB power adapter.

Insert it until it clicks into place.

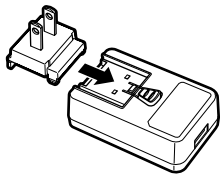

- 2** Open the terminal cover, and connect the USB cable to the USB/AV OUT terminal.

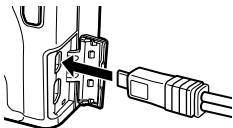

- 3** Connect the USB cable to the USB power adapter.

- 4** Plug the USB power adapter into a power outlet.

The autofocus/flash lamp turns on and charging starts.

Depending on the battery level, the charging time differs. An exhausted battery will be fully recharged in about three hours (at 25°C (77°F)).

When charging is complete, the autofocus/flash lamp turns off. Unplug the USB power adapter from the power outlet.

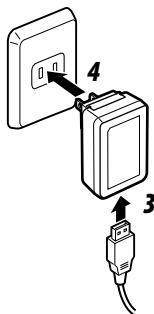

**Storage Capacity**-----

- Approximately 290 pictures can be taken when the battery is fully charged.
- This is based on tests conducted according to CIPA standards under the following conditions: At 23°C (73°F) temperature; the picture display is on; a picture is taken every 30 seconds; the flash is fired every two pictures; the camera is turned off and back on after 10 pictures are taken.
- The storage capacity is for reference. For long periods of use, it is recommended that you carry spare batteries.

**Caution**-----

- Use only genuine rechargeable battery (DB-65).
- If the autofocus/flash lamp blinks during charging, the USB power adapter or battery has a problem. Unplug the USB power adapter from the power outlet and remove the battery.
- The battery may become very hot immediately after operation. Turn the camera off and leave it to cool down sufficiently before removing the battery.

**Note**-----

- You can also charge the battery by connecting the camera to a computer using the USB cable. An exhausted battery will be fully recharged in about 5 hours. (p.131)
- DB-65 can be recharged with the optional battery charger (BJ-6). (Recharging time: Approximately 2.5 hours)

## Turning the Camera On and Off

Press the POWER button to turn the camera on.

The POWER button lamp lights, and then the autofocus/flash lamp blinks for several seconds.

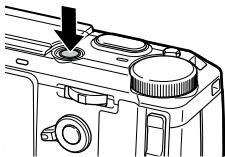



When the POWER button is pressed again, the power turns off.

## Turning the Camera On in Playback Mode

When the  button is pressed and held with the camera turned off, the camera turns on in playback mode.

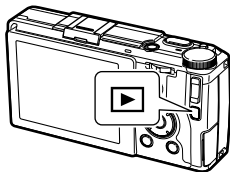
When the camera is turned on in playback mode, you can perform the following operations.





Press  button	Turns off the power of the camera.
Press the shutter release button halfway	Switches the camera to shooting mode.

## Turning the Camera On with the Wi-Fi Function Enabled

When the  button is pressed and held with the camera turned off until a beep sounds, the camera turns on with the Wi-Fi function enabled. (p.135)



### Caution

- When the Wi-Fi function is enabled using the  button, the camera is not switched to shooting mode even if the shutter release button is pressed. When performing shooting or other operations, press the  button to turn the camera off and press the POWER button to turn the camera back on.

**Note**

- To save the battery power, you can set the following functions in the [Setup] menu.

	Operation	When the setting is disabled
Auto Power Off	The camera will turn off automatically if no operations are performed during the set time. You can set this to [Off] or a certain number of minutes up to 30 minutes in increments of 1 minute. To resume operation, turn the camera on again.	<ul style="list-style-type: none"> <li>During movie recording</li> <li>During multiple exposure shooting, interval shooting, or interval composite</li> <li>During movie playback or slide show</li> <li>During processing</li> <li>While Wi-Fi connection is established</li> <li>While the camera is connected to a computer</li> </ul>
Sleep Mode	The camera dims the display automatically if no operations are performed during the set time. You can set this to [Off] or a certain number of minutes up to 30 minutes in increments of 1 minute. To resume display brightness, operate the camera.	<ul style="list-style-type: none"> <li>During multiple exposure shooting, interval shooting, or interval composite</li> <li>During playback</li> <li>While the camera is connected with an AV or HDMI cable</li> <li>While the Wi-Fi function is enabled</li> </ul>
LCD Auto Dim	The camera dims the display automatically if the camera is not moved within five seconds. You can select [On] or [Off].	

- The POWER button lamp can be set to [On] or [Off] in [Power Button Lamp] of the [Setup] menu.

## Setting the Date and Time

When the power is turned on for the first time, the [Date Settings] screen appears.

### 1 Set the year, month, day, hour, minute, and date format.

Press ◀▶ to select an item, and press ▲▼ to change the value.

To cancel the setting, press the ↶ button.



### 2 Press the MENU/OK button.

A confirmation screen appears.

### 3 Press the MENU/OK button.

The date is set.



#### Note

- If the battery is removed for about five days, the date and time settings will be lost. To retain the date and time settings, insert a battery with sufficient power for at least two hours, and then remove the battery.
- The set date and time can be changed in [Date Settings] of the [Setup] menu.
- The language displayed for the menus and messages can be changed in [Language/言語] of the [Setup] menu.





# First Steps

**Read this section before using your camera for the first time.**

Basic Shooting.....	32
Playing Back Images .....	38
Using the Menu.....	39

## Basic Shooting

Now you are ready.

### Shooting with Auto Settings

#### 1 Turn the mode dial to .

Turn the mode dial while pressing the mode dial lock release button.

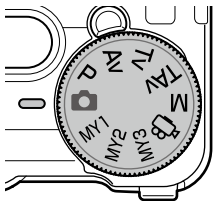

#### 2 To use the flash, slide the OPEN switch down.

The flash opens.

The autofocus/flash lamp blinks while the flash charges. Once the flash is charged, the lamp turns off and the camera is ready to shoot.

The flash will not fire when the flash cover is closed.

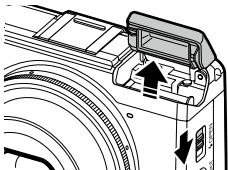

#### 3 Press the shutter release button halfway.

Focus is adjusted, and exposure is set.

The distance is measured from up to nine points and the green focus frame appears for the area in focus.



#### 4 Press the shutter release button fully.

The image you have just taken is displayed on the picture display and saved.



## Focus

- The autofocus/flash lamp and the frame color show whether the subject is in focus.

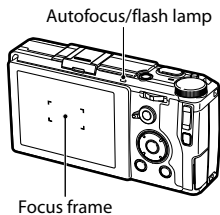



Focus status	Frame color	Autofocus/flash lamp
Before focusing	White *1	Off
Subject in focus	Green	Green (on)
Unable to focus	Red (blinks)	Green (blinks)

\*1 The frame color is blue when a face is recognized in  mode or with [Effect] set to [Portrait].

- The camera cannot focus or a subject may not be in focus even if the focus frame is displayed in green in the following cases.
  - Objects that lack contrast (the sky, a white wall, the hood of a car, etc.)
  - Flat objects with only horizontal lines
  - Fast-moving objects
  - Objects that are poorly lit
  - Objects with bright reflections or backlighting
  - Flickering objects, such as fluorescent lights
  - Point light sources (light bulbs, spotlights, or LEDs)

If the camera is unable to focus, lock focus on another object at the same distance from the camera as your subject, then take the picture.

**Note**

- In  mode, pictures are taken with the following settings.
  - ISO Setting [Auto-Hi]
  - Noise Reduction [Auto]
  - Exposure Metering [Multi]
  - Focus “Face recognition priority AF”
  - Auto Macro
  - White Balance [Multi-P AUTO]
  - Flash [Auto]
 The settings cannot be changed for the above functions.
- Select [Off], [0.5 seconds], [1 second], [2 seconds], [3 seconds], or [Hold] in [LCD Confirmation Time] of the [Setup] menu to choose how long an image is displayed on the picture display after shooting. When set to [Hold], the image remains displayed until the next time you press the shutter release button halfway or turn the mode dial.
- Keeping the shutter release button pressed halfway after shooting holds the focus, aperture, shutter speed, ISO, and white balance settings. The shooting conditions are not held in the following cases:
  - Self-timer
  - Interval Shooting
  - Interval Composite
  -  mode

**Self-timer**

The self-timer can be set to [Self-Timer 2 Sec] or [Custom Self-Timer]. The [Self-Timer 2 Sec] setting is useful for preventing camera shake. With [Custom Self-Timer], you can set the number of pictures and the shooting interval.

**1**

Press the  button.

The self-timer setting screen appears.

**2**

Press the  button to select [Self-Timer 2 Sec] or [Custom Self-Timer].

**3**

Shoot.

The AF auxiliary light lights when the self-timer starts.

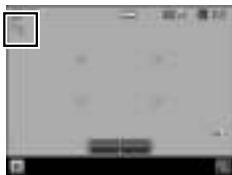

**Note**

- The camera remains in self-timer mode even after shooting. To cancel the self-timer, change the self-timer setting to [Self-Timer Off] in Step 2.
- When the self-timer is set to [Self-Timer 2 Sec], the AF auxiliary light does not light.
- When [Custom Self-Timer] is set, set the following items in [Custom Self-Timer] of the [Shooting] menu.

Number of pictures	1 to 10 (Default setting: 2)
Shooting interval	5 to 10 sec. (Default setting: 5 sec.)

When the number of pictures is two or more, the focus is fixed at the position of the first shot.

**Caution**

- The  button is used as the Fn2 button. The self-timer cannot be used when a function other than the self-timer is registered with [Set Fn2 Button] of the [Key Custom Options] menu. (p.122)
- When [Continuous Mode] is set, the self-timer cannot be used.
- [Custom Self-Timer] cannot be selected in the following cases.
  - When the focus is set to [Subj. Tracking]
  - During Interval Shooting
  - During Interval Composite

## Checking the Camera Level and Tilt

This camera has a built-in level indicator that can be used to indicate the level and tilt of the camera on the picture display. You can check for the horizontal level and tilt in the forward-backward direction.

The level is indicated by the tilt of the horizontal line, and the tilt in the forward-backward direction is indicated by the deviation of the horizontal line from the reference line. When the indicator color is yellow, the camera is not level or is tilted. When the indicator color is green, the camera is level or is not tilted.

### 1 Press and hold the DISP. button.

The menu appears.

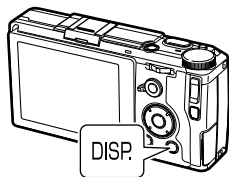

### 2 Press the ▲▼ buttons to select a setting.

Off	Displays no indicators.
Level + Tilt	Displays the level and tilt indicators. (Default setting)
Level	Displays only the level indicator.



### 3 Press the MENU/OK button.

The indicator is displayed on the shooting screen.



When level



When tilted to the right



When tilted forward



When tilted too far or unable to measure tilt

**Note**

- The indicators are displayed only when [Level Indicator] is set to [On] in [DISP. Button Display Setting] of the [Setup] menu. (p.125)
- The indicators can also be set in [Level Setting] of the [Setup] menu. You can use [Level (Tilt) Calibration] of the [Setup] menu to set the current camera tilt as the reference setting.

**Caution**

- The level indicator does not operate when the camera is upside down, movies are being recorded, or during interval shooting.
- The level function becomes less accurate when the camera is moving or when shooting in an environment subject to movement, such as in a vehicle.
- Use this function as reference to see if images are level when shooting. The accuracy cannot be guaranteed when using the camera as a level.

## Playing Back Images

Images can be viewed on the picture display.



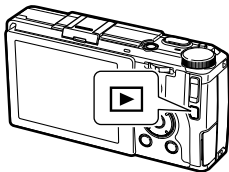

### 1 Press the button.

The camera switches to playback mode and the last image you took is displayed.



### 2 View the images.

You can perform the following operations.

 button	Displays the previous image.
Press and hold  button	Fast-reverses playback.
 button	Displays the next image.
Press and hold  button	Fast-forwards playback.

To switch the camera back to shooting mode, press the  button again or press the shutter release button halfway.



#### Note

- You can select the display order from [File Numbers] or [Sht. Date/Time] in [Playback Order Options] of the [Setup] menu.
- Images are switched in the effect that the next image slides over the previous image from right to left. To deactivate this effect, set [Playback Animation] of the [Setup] menu to [Off].



#### Auto Rotate

- When [Auto Rotate] of the [Setup] menu is set to [On], images are rotated automatically according to the camera orientation.
- Images taken with [Auto Bracket] are rotated automatically according to the orientation of the first image.
- Auto Rotate does not work in the following cases.
  - When playing back movies
  - In thumbnail view
  - During [Slide Show] playback
  - When playing back images on AV equipment



## Using the Menu

### 1 Press the MENU/OK button.

The menu appears.

The menu that is displayed first varies depending on the mode when the button is pressed.

To change the menu, press the ◀ button, use the ▲▼ buttons to select a tab, and then press the ▶ button.



### 2 Press the ▲▼ buttons to select an item.

Pressing the +/- button moves the cursor to the head of the menu delimiter (horizontal line).



### 3 Press the ▶ button.

The options are displayed.

### 4 Press the ▲▼ buttons to select an option.



### 5 Press the MENU/OK button, or press the ◀ button and then the MENU/OK button.

The setting is set.



#### Note

- For details of the menus, see "Menus". (p.145)



# Advanced Operations

**Read this section when  
you want to learn more  
about the different  
camera functions.**

1	Various Shooting Functions....	42
2	Playback Functions.....	95
3	Changing Camera Settings ...	114
4	Making Use of Images.....	130
5	Menus.....	145
6	Appendices .....	155

1

2

3



4

5

6

# 1 Various Shooting Functions

Select a shooting mode to match the scene.

Mode	Purpose	Page
	For easy shooting	p.32
P/Av/Tv/TAv/M	For shooting with a set aperture value and shutter speed	p.42
	For recording movies	p.92
MY1/MY2/MY3	For shooting with your favorite settings	p.117

## Shooting with a Set Exposure

Set an aperture value or shutter speed when shooting. The following values can be set.

Yes: Can be set No: Automatically set by the camera

Mode	Aperture value	Shutter speed	ISO sensitivity
<b>P</b> Program Shift	*1	*1	Yes
<b>Av</b> Aperture Priority	Yes	No	Yes
<b>Tv</b> Shutter Priority	No	Yes	Yes
<b>TAv</b> Shutter/Aperture Priority	Yes	Yes	Yes*2
<b>M</b> Manual Exposure	Yes	Yes	Yes*3

\*1 Allows you to select the combination of aperture value and shutter speed.

\*2 Only [Auto] and [Auto-Hi] are available.

\*3 [Auto] and [Auto-Hi] are not available.

## 1 Set the mode dial to P/Av/Tv/TAv/M.

The symbol for the selected shooting mode and the set value are displayed on the shooting screen.

In M mode, the exposure indicator is displayed.

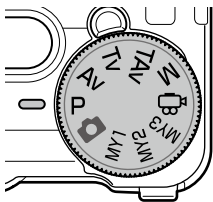

## 2 Turn the up-down dial or press the ADJ. lever left or right to change a value.

The following values are changed.

Mode	Up-down dial	ADJ. lever
<b>P</b>	Program Shift	—
<b>Av</b>	Aperture value	—
<b>Tv</b>	Shutter speed	—
<b>TAv/M</b>	Aperture value	Shutter speed

When the aperture value and shutter speed are displayed in P mode (after the shutter release button is pressed halfway or in other situations), the Program Shift is available using the up-down dial.

When in M mode, the exposure is correct when the indicator is in the center. When the exposure value is in the range of -2EV to +2EV, the indicator changes according to the exposure value. The indicator turns yellow when the values are outside this range.



## 3 Shoot.

**Note**

- The functions for the up-down dial and ADJ. lever when in Tv and M modes can be switched in [M/Tv Mode Dial Setting] of the [Key Custom Options] menu.
- You can set whether to automatically adjust the exposure when the correct exposure cannot be obtained for the aperture value and shutter speed set in Av, Tv, and TvAv modes in the [Shooting] menu.

Mode	[Shooting] menu	Setting
<b>Av</b>	Auto Aperture Shift	Off, On
<b>Tv</b>	Shutter Speed Auto Shift	Off, On
<b>TvAv</b>	Shutter/Aperture Auto Shift	Off, Aprtr Priority, Shttr Priority

**Caution**

- When a slow shutter speed has been set, images are not displayed on the picture display during shooting.
- When the picture display is set to off, the aperture value and shutter speed cannot be changed. If [Information Display Mode] of the [Setup] menu is set to [On], these values can be changed.

**Program Diagram**

- You can select the program diagram for P and M modes in [P Mode Selection] of the [Shooting] menu. Diagrams 1 and 2 show the program diagram for each setting.
- The program diagram is the guide for possible shift in a particular aperture value and shutter speed combination and changes depending on the exposure value. (The example shows when the ISO sensitivity is [ISO 100].)
- When [One Press M Mode] of the [Key Custom Options] menu is set to [Program], the aperture value and shutter speed are adjusted according to the program settings.

Diagram 1: Normal

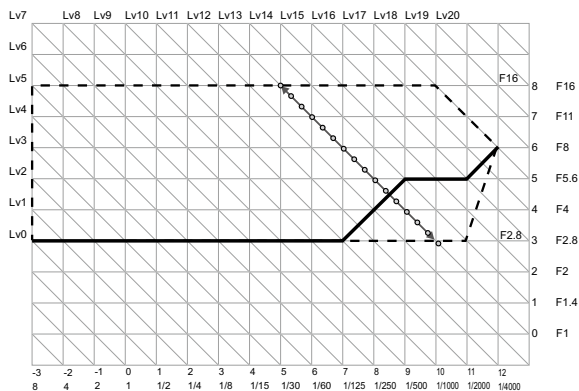
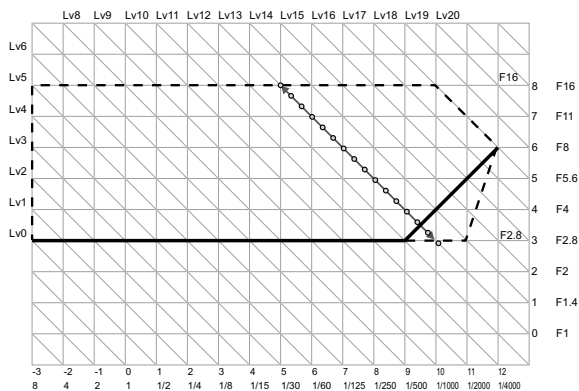

Diagram 2: Max Aperture Prior.





## Bulb/Time

- You can select between B (Bulb) and T (Time) for the shutter speed in M mode.

Shutter speed	Operation
<b>B</b>	The image continues to be exposed while the shutter release button is pressed. The exposure ends when the shutter release button is released.
<b>T</b>	The exposure begins when the shutter release button is pressed. The exposure ends when the shutter release button is pressed again.

In either mode, the camera automatically stops shooting once the limit has been reached.

ISO sensitivity	Shutter speed limit
ISO 100 to ISO 3200	300 sec.
ISO 3201 to ISO 25600	30 sec.

- Operation is also possible using the optional cable switch (CA-2).
- The following functions are not available.
  - Self-timer
  - Continuous Mode
  - Auto Bracket
  - Interval Shooting
  - Interval Composite
  - One Press M Mode
- When using B/T, and [Continuous Mode] is set in the [Shooting] menu, B/T is canceled, and the shutter speed for continuous shooting is set to 300 seconds. If [Continuous Mode] is set first, B/T cannot be set.









## Slow Shutter Speed NR

- Using a long shutter speed results in a noisy image. When [Slow Shutter Speed NR] of the [Shooting] menu is set to [On], noise reduction processing is carried out depending on the combination of the ISO sensitivity and shutter speed settings. However, it takes some time to save the processed image.

ISO sensitivity	Shutter speed at the start of processing
ISO 3200 or less	8 seconds or more
ISO 3201 or more	4 seconds or more



## Aperture Preview

- When [Effect Button Hold Setting] of the [Key Custom Options] menu is set to [Aperture Preview], the Aperture Preview is available using the  (Effect) button. If you press and hold the  (Effect) button when the aperture value is displayed on the shooting screen (such as when the shutter release button is pressed halfway), the aperture value set when shooting operates, and you can check the depth of field. When you release the  button, the Aperture Preview mode is canceled.
- When [Effect Button Hold Setting] is set to [Wi-Fi] (default value), the  button works as the switch to turn on/off the Wi-Fi function. In this case, the Aperture Preview is not available. (p.134)
- In the Aperture Preview mode, the shutter release button cannot be pressed fully, and the aperture value cannot be changed.
- When using the flash, the actual aperture value may differ from the Aperture Preview.
- Because the Aperture Preview is used for checking the depth of field, it may not function properly with AE.
- When [Auto Bracket] of the [Shooting] menu is set in Tv mode, the Aperture Preview is displayed according to the set exposure compensation values.
- [AE-BKT 1/3EV] and [AE-BKT 1/2EV] of [Auto Bracket] settings in the [Shooting] menu are not reflected.
- This function is not available in  mode.

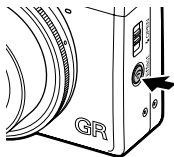

## Using Exposure Compensation

### 1 Set a value using the $\pm$ button.

Settings can be made in the range from -4.0 EV to +4.0 EV (from -2.0 EV to +2.0 EV in  $\text{M}$  mode).

You can also shoot while the [Exposure Compensation] screen is displayed.



### 2 Press the MENU/OK button.

The shooting screen reappears, and the setting is displayed on the screen.

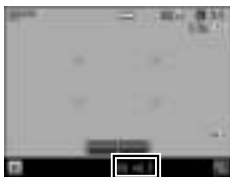

#### Note

- The settings can also be made in [Exposure Compensation] of the [Shooting] menu.
- When [Shutter Button Confirmation] of the [Key Custom Options] menu is set to [On], the exposure compensation setting can be set by pressing the shutter release button halfway.
- This function is not available in M mode. If the  $\pm$  button is pressed, the exposure is automatically adjusted to the correct exposure. You can select the priority of values in [One Press M Mode] of the [Key Custom Options] menu.

Aprtr Priority	Sets the aperture value to a fixed value and adjusts the shutter speed.
Shttr Priority	Sets the shutter speed to a fixed value and adjusts the aperture value.
Program	Adjusts both the aperture value and shutter speed.

## Setting the ISO Sensitivity

Set the ISO sensitivity in [ISO Setting/NR] of the [Shooting] menu.

Auto	In ISO 100 to ISO 800, the camera automatically adjusts sensitivity according to brightness, the distance to the subject, macro settings, and the format.
Auto-Hi (high sensitivity auto)	The sensitivity can be set higher than in [Auto]. <ul style="list-style-type: none"><li>You can set the upper/lower limit of the ISO sensitivity, the shutter speed for switching the ISO sensitivity settings in [ISO Auto-High Settings] of the [Setup] menu.</li></ul>
ISO 100 to ISO 25600	Sensitivity is set to the selected ISO value.



### Note

- In [ISO Step Setting] of the [Setup] menu, ISO sensitivity setting steps can be selected. Depending on the setting, the following ISO sensitivity can be selected.

ISO Step Setting	Selectable ISO sensitivity
1EV	ISO 100, ISO 200, ISO 400, ISO 800, ISO 1600, ISO 3200, ISO 6400, ISO 12800, ISO 25600
1/3EV	ISO 100, ISO 125, ISO 160, ISO 200, ISO 250, ISO 320, ISO 400, ISO 500, ISO 640, ISO 800, ISO 1000, ISO 1250, ISO 1600, ISO 2000, ISO 2500, ISO 3200, ISO 4000, ISO 5000, ISO 6400, ISO 8000, ISO 10000, ISO 12800, ISO 16000, ISO 20000, ISO 25600

When [1/3EV] is selected for the steps for ISO sensitivity, the setting steps for [Change Shutter Speed] of [ISO Auto-High Settings] of the [Setup] menu also changes to 1/3EV steps.

- When [ISO Setting/NR] is set to [Auto] or [Auto-Hi], the ISO sensitivity is displayed on the screen when the shutter release button is pressed halfway. The displayed ISO sensitivity may differ from the actual setting when the flash is used.
- Images taken with a higher sensitivity may appear grainy.
- If the flash is used when [ISO Setting/NR] is set to [Auto], the ISO sensitivity is increased up to the equivalent of ISO 1600.
- When [Dynamic Range Compensation] is set in the [Shooting] menu, the ISO sensitivity that can be set is limited. (p.51)
- In the [Key Custom Options] menu, [ISO] can be registered to use to the ADJ. lever and the Fn1, Fn2, and Effect buttons. (p.120, p.122)  
[ISO] is registered to [ADJ. Lever Setting 1] as the default setting.
- If [ADJ. Direct ISO Control] of the [Key Custom Options] menu is set to [On], you can change the ISO sensitivity simply by pressing the ADJ. lever left or right in P, Av, or Tv mode.

## Reducing Noise

You can reduce the amount of noise in still images.

- 1** In the [Shooting] menu, select [ISO Setting/NR], and then press the **▶** button.

The [ISO Setting/Noise Reduction] screen appears.

- 2** Press the **▲▼** buttons to select [Noise Reduction], and then press the **▶** button.

- 3** Press the **▲▼** buttons to select [Off], [Auto], or [Manual].

When [Off] or [Auto] is selected, proceed to Step 5.

- 4** Press the **▲▼◀▶** buttons to specify the ISO sensitivity to apply to [Strong], [Medium], and [Weak].



- 5** Press the MENU/OK button twice.

The symbol appears on the shooting screen.

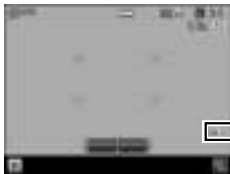

### Caution

- When noise reduction is set, it may take longer than normal to save images.

## Dynamic Range Compensation

With [Dynamic Range Compensation] of the [Shooting] menu, you can expand an image gradation to make the bright and dark portions of an image clearly visible. You can select from [Off], [Auto], [Weak], [Medium], and [Strong].

When dynamic range compensation is set, a symbol appears on the screen.

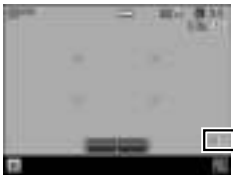

### Caution

- When dynamic range compensation is set, available ISO sensitivity is limited.

Setting	ISO Step Setting [1EV]		ISO Step Setting [1/3EV]	
	Min.	Max.	Min.	Max.
Auto	ISO 400	ISO 6400	ISO 320	ISO 8000
Weak	ISO 200	ISO 12800	ISO 160	ISO 16000
Medium	ISO 200	ISO 12800	ISO 200	ISO 12800
Strong	ISO 400	ISO 6400	ISO 320	ISO 8000

- If dynamic range compensation is set, the [Auto-Hi] setting of the ISO sensitivity works as [Auto].
- When [ISO Setting] is set to [Auto], shooting may be performed with a lower ISO sensitivity than the minimum sensitivity listed above depending on the shooting conditions.
- When [Dynamic Range Compensation] is set to [Strong], noise tends to occur more easily in images.
- [Dynamic Range Compensation] cannot be set in the following cases.
  - Continuous Mode
  - Multiple Exposure Shooting
  - Interval Shooting
  - Interval Composite
- When the shooting location is too bright or too dark, dynamic range compensation may not be effective.





### Note

- When using dynamic range compensation, it is recommended to set [Exposure Metering] of the [Shooting] menu to [Multi]. (p.52)
- In the [Key Custom Options] menu, [Dyn Range Comp] can be registered to use to the ADJ. lever and the Fn1, Fn2, and Effect buttons. (p.120, p.122)

## Selecting a Metering Method

Set the metering method in [Exposure Metering] of the [Shooting] menu.

Multi	The camera meters exposure in 484 areas of the frame. (Default setting)
 Center	The entire image is metered, with emphasis on the center, to determine the exposure value. Use this setting when the brightness of the center and surroundings are different.
 Spot	The center of the image is metered to determine the exposure value. Use this setting when you want to use the brightness at the center. This is useful if there is a marked difference in contrast or backlighting.

If [Center] or [Spot] is selected, the symbol appears on the shooting screen.

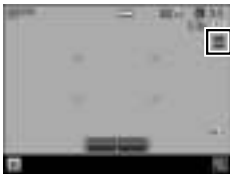

### Note

- Metering is fixed to [Multi] in the following cases.
  - When the focus is set to [Subj. Tracking]
  - In  mode
- When the target is moved in [FA/Move Target] of the [Shooting] menu, metering is fixed to [Spot].
- In the [Key Custom Options] menu, [Expo. Metering] can be registered to use the ADJ. lever and the Fn1, Fn2, and Effect buttons. (p.120, p.122)  
[Expo. Metering] is registered to [ADJ. Lever Setting 5] as the default setting.

## Using the ND Filter

With [ND Filter] in the [Shooting] menu, you can set whether or not to always use the camera's internal ND filter.

Off	The ND filter is not used.
Auto	The ND filter is used when the exposure is outside the linked range. The ND filter is used if the icon is displayed on the shooting screen when the shutter release button is pressed halfway. The ND filter is not used in P and M modes.
On	The ND filter is always used. The icon is displayed on the shooting screen.



### Note

- If [ND Filter] is set to the Fn1, Fn2, and Effect buttons in the [Key Custom Options] menu, [Off], [Auto], and [On] for the ND filter can be switched with button operation only. (p.122)

## Setting a Picture Format

With [Picture Format] of the [Shooting] menu, you can set the picture format, size, and aspect ratio.

Format/Size	<b>RAW</b> : Records a <b>L</b> sized RAW image (DNG format).
	<b>RAW+</b> : Records a RAW image simultaneously with a <b>L</b> sized JPEG image.
	<b>L</b> : 16M (3:2)
	<b>M</b> : 10M (3:2)
	<b>S</b> : 5M (3:2)
	<b>XS</b> : 1M (3:2)
Aspect Ratio	3:2, 4:3, 1:1



### Note

- When the aspect ratio is set to [3:2] or [1:1], black band(s) appears at the lower side or right and left sides of the picture display.
- In the [Key Custom Options] menu, [Picture Size] and [Aspect Ratio] can be registered to use to the ADJ. lever and the Fn1, Fn2, and Effect buttons. (p.120, p.122)  
[Picture Size] is registered to [ADJ. Lever Setting 2], and [Aspect Ratio] is registered to [ADJ. Lever Setting 3] as the default setting.  
If [JPEG>RAW] or [JPEG>RAW+] is set to the Fn1, Fn2, and Effect buttons, the image format can be switched with button operation only.



### Shooting RAW Images

- RAW images can be processed in [RAW Development] of the [Playback] menu or using the included software "Digital Camera Utility 5" (p.108, p.130)
  - The following functions are not reflected in RAW images. [Effect] and [Dynamic Range Compensation] can be reflected when a RAW image is converted to JPEG format in [RAW Development] of the [Playback] menu.
    - Effect
    - Dynamic Range Compensation
    - Date Imprint
- When **RAW+** is set, the functions mentioned above are reflected in JPEG images only.





## Crop

- If [Crop] of the [Shooting] menu is set to [35 mm] or [47 mm], the 35 mm equivalent angle of view is changed from default 28 mm to 35 mm or 47 mm, and the image display is also changed.
- When [Crop] is set, available format and size are limited.

Crop	Format/Size limitation
35 mm	<b>L</b> cannot be used.
47 mm	<b>L</b> and <b>M</b> cannot be used.









- If [28/35 mm] or [28/35/47 mm] is set to the Fn1, Fn2, and Effect buttons in the [Key Custom Options] menu, the angles of view can be switched with button operation only. (p.122)

# Setting the Focus

## Selecting a Focusing Method

Set the focusing method in [Focus] of the [Shooting] menu.

 Multi AF	Measures the distances from 9 AF areas and focuses to the nearest AF area. This prevents the center of the picture display from becoming out of focus and enables you to shoot with a minimum number of out-of-focus pictures. (Default setting)
 Spot AF	Focuses on the area in the center of the frame.
 Pinpoint AF	Focuses on a smaller area than [Spot AF].
 Subj. Tracking	<p>Tracks the subject and continually focuses.</p> <p>When the shutter release button is pressed halfway, the subject inside the frame in the center of the picture display is set as the target to be tracked, and a green target symbol appears. When a tracking target cannot be found, the frame flashes red.</p> <p>Automatic tracking is canceled after shooting, or in the following cases.</p> <ul style="list-style-type: none"><li>• When the tracking target moves out of the frame</li><li>• When the shutter release button is released</li><li>• While the flash is charged</li></ul>
 MF MF (Manual Focus)	Focuses manually. (p.58)
 S Snap	Fixes the focus to the set distance. (p.58)
 ∞ ∞ (Infinity)	Fixes the focus distance at infinity. This is useful for shooting distant scenes.

**Note**

- The focus speed of the autofocus can be selected from [Normal] or [High Speed] in [AF Mode] of the [Setup] menu. If [High Speed] is selected, the focus speed of the autofocus becomes fast. However, the picture display turns off during autofocusing. [High Speed] is not available in the following cases.
  - When the focus is set to [Subj. Tracking]
  - During Continuous AF
  - When the target is moved
- In the [Key Custom Options] menu, [Focus] can be registered to use to the ADJ. lever and the Fn1, Fn2, and Effect buttons. (p.120, p.122)  
[Focus] is registered to [ADJ. Lever Setting 4] as the default setting.  
If the following functions are set to the Fn1, Fn2, and Effect buttons, the focus methods can be switched with button operation only.
  - MultiAF/SpotAF
  - MultiAF/PinpointAF
  - AF/MF
  - AF/Snap
  - AF/Subj.Trckng

**Caution**

- In [Subj. Tracking], the following functions are not available.
  - Self-Timer [Custom Self-Timer]
  - Interval Shooting
  - Interval Composite
  - FA/Move Target

## Focusing Manually (Manual Focus)

If the camera fails to focus automatically, you can focus manually.

The manual focus enables shooting at a fixed distance.

### 1 In [Focus] of the [Shooting] menu, select [MF].

The symbol and focus bar appear in the shooting screen.

In P, Av, TAv, and M modes, and when using Interval Composite, a depth of field approximation appears.

### 2 Press the **▲** button.

▶ appears on the focus bar.

### 3 Use the up-down dial to adjust the focus.



## Fixing the Focus to the Set Distance (Snap)

### 1 In the [Shooting] menu, select [Snap Focus Distance], and then press the **▶** button.

### 2 Press the **▲▼** buttons to select a distance, and then press the **◀** button.

Distances can be selected from [1m], [1.5m], [2m], [2.5m], [5m], and [∞].

### 3 In [Focus] of the [Shooting] menu, select [Snap].

The camera focuses on the set distance.

To change the distance, turn the up-down dial while pressing the **▲** button.





**Note** -----

- In the [Key Custom Options] menu, [SnapFocusDist.] can be registered to use to the ADJ. lever and the Fn1, Fn2, and Effect buttons. (p.120, p.122)

## Shooting Close-ups (Macro Mode)

You can approach the subject up to 10 cm (shooting range: approx. 12 × 8 cm) away from the front edge of the lens to shoot.

**1** Press the  (▲) button in shooting mode.

 appears on the shooting screen.

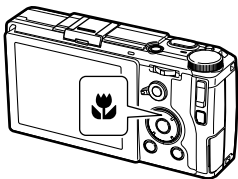

**2** Shoot.

To cancel macro mode, press the  button again.





### Note

- [Focus] operates as [Spot AF] or [Pinpoint AF].



### Caution

- In  mode, Auto Macro is set, and the  button is deactivated.
- When [Focus] is set to [MF], macro mode is not available. Pressing the  (▲) button enables focus distance adjustment. (p.58)

## Using the AF Button

When the AF button is used, AE lock or AF lock is available in place of pressing the shutter release button halfway.

You can use the AF function switching lever to switch the AF button function.

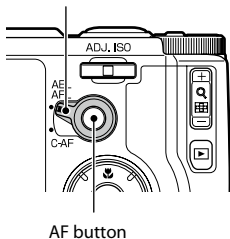

### When the AF Function Switching Lever is Set to AEL/AFL

The AF button operation can be selected from [Off], [Multi AF], [Spot AF], or [Pinpoint AF] in [AFL Focus Settings] of the [Key Custom Options] menu. (The AF button operation is not available for pressing the shutter release button halfway.) When [AFL Focus Settings] is set to [Off], the AF operates following the [AEL/AFL Setting] of the [Key Custom Options] menu.

AEL/AFL Setting	Focus	AF button lock operation
AFL	Multi AF, Spot AF, Pinpoint AF	Follows the setting in [Focus] of the [Shooting] menu to focus and then locks the focus.
	Subj. Tracking, MF, Snap, $\infty$	Focuses using Spot AF and then locks the focus.
AEL-AFL	Multi AF, Spot AF, Pinpoint AF	Sets AE Lock and follows the setting in [Focus] of the [Shooting] menu to focus, and then locks the focus.
	Subj. Tracking, MF, Snap, $\infty$	Sets AE Lock and focuses using Spot AF, and then locks the focus.
AEL		Sets AE lock.



## Note

- In [AEL/AFL Lock keep Setting] of the [Key Custom Options] menu, you can set whether or not to maintain the lock even when you release the AF button.

Off	Locks the focus only while the button is pressed.
On	Locks the focus when the button is pressed, and cancels the focus when the button is pressed again.

- When the focus is locked with the AF button, the button is deactivated.
- When functions such as the focus method switching function and [FA/Move Target] are registered to the Fn1, Fn2, and Effect buttons in the [Key Custom Options] menu, the functions registered in the buttons become invalid while the AF lock is set. If the button setting is changed while the AF lock is set, the AF lock is canceled.
- When AF lock cannot be set, or when AF lock is canceled, the focus position moves to the position set in [Focus].
- When the focus is locked with the AF button, the AE/AF lock position does not change even when the shutter release button is pressed halfway.

## When the AF Function Switching Lever is Set to C-AF

While the AF button is pressed, "Continuous AF" which continuously focuses on the subject will be active, regardless of the [Focus] setting.



### Note

- A green frame appears when the camera has finished focusing. The focus sound is not played.
- If the shutter release button is pressed fully while pressing the AF button, continuous shooting can be performed following the [C-AF Continuous Setting] of the [Key Custom Options] menu. Continuous shooting ends once the AF button is released.

Off	Performs continuous shooting only when [Continuous Mode] is set in the [Shooting] menu.
AF Priority	Performs continuous shooting by focusing for each shot while the shutter release button is pressed.
Shutter Priority	Performs continuous shooting while the shutter release button is pressed. The focus is fixed. (p.72)

- If the [Focus] is set to [MF], the focus can be locked when the AF button is released. It is easier to operate when placing your index finger on the shutter release button, and using your thumb for the AF button.



### Caution

- "Continuous AF" is not available in the following cases.
  - In self-timer mode
  - In  mode
  - During Multiple Exposure Shooting
  - During Interval Shooting
  - During Interval Composite



## Setting Focus Assist and AE/AF Target

Without moving the camera you can meter a specific spot on the subject using buttons only, and activate the focus lock. This function is useful for shooting on a tripod.

- 1** In the [Shooting] menu, select [FA/Move Target], and then press the **▶** button.

The target setting screen appears.

- 2** Set the target position and size.



The following operations are available.

<b>▲▼◀▶</b> buttons	Moves the target.
Up-down dial	Portion magnification: Changes the display area. Whole magnification: Changes the size of the focus assist area when the magnification is the same ratio.
<b>+/-</b> button	Changes the magnification factor.

### 3 For detailed settings, press the Fn2 button.



The following settings are available.

Move Target Setting	Specifies the target to move from [AE-AF], [AF], and [AE] (from [AE-MF], [MF], and [AE] when [Focus] is set to [MF]).
Focus Assist Setting	Intensifies the outlines and contrast inside the area, making it easier to adjust the focus. [MODE 1] Emphasizes edges. [MODE 2] Emphasizes outlines. [MODE 3] Inverts black and white for MODE 1. [MODE 4] Inverts black and white for MODE 2.
Magnification Setting	Specifies the magnification area. [Magnify portion]: Magnifies the target area and overlays the display on the background. You can check the focus while looking at the overall composition. [Magnify whole]: The target area is magnified full-screen, and the target can be moved while magnified. This function allows you to check the focus more closely than with [Magnify portion]. The magnification factor can be changed with the <b>+/-</b> button.

If you press the MENU/OK button, the screen in Step 2 reappears.



### 4 Press the MENU/OK button.

The shooting screen reappears.



Target

**Caution** -----

- [FA/Move Target] cannot be set in the following cases.
  - In  and  modes
  - When the focus is set to [Subj. Tracking]
- When [Magnification Setting] is set to [Magnify whole], [One Press M Mode] is not available.

**Note** -----

- If [Focus] is changed to [Subj. Tracking], the target position is reset.
- In the [Key Custom Options] menu, [FA/Move Target] can be registered to use to the Fn1, Fn2, and Effect buttons. (p.122)  
[FA/Move Target] is registered to the Fn1 button as the default setting.

## Shooting with a Single Press of the Shutter Release Button (Full Press Snap)



While pressing the shutter release button halfway operates AF, pressing the shutter release button fully quickly performs shooting at the set focal distance. This function is called “Full Press Snap”. The camera focuses at the distance set in [Snap Focus Distance] of the [Shooting] menu (p.58).

Set [Full Press Snap] of the [Shooting] menu.

Off	Operates the same way as AF.
On	Performs shooting by focusing at the distance set in [Snap Focus Distance] when the shutter release button is fully pressed.
Auto-Hi ISO	Performs shooting by focusing at the distance set in [Snap Focus Distance] with the ISO sensitivity set to [Auto-Hi] when the shutter release button is fully pressed.



### Caution

- “Full Press Snap” is not available in the following cases.
  - In  and  modes
  - In macro mode
  - In self-timer mode













### Note





- “Full Press Snap” is available when [Focus] is set to [Multi AF], [Spot AF], [Pinpoint AF], or [Subj. Tracking].
- Even when [Full Press Snap] is set to [On], the camera focuses at the setting in [Focus] when the shutter release button is pressed halfway.

## Setting the White Balance

Make adjustments to the white balance so that white subjects will appear white under any kind of light.

If the white balance is not how you thought it would be when shooting an object of a single color or when shooting under multiple light sources, change the setting.

 Auto	Adjusts the white balance automatically.
 Multi-P AUTO	Automatically optimizes the white balance to match each of the separate areas of light even when multiple light sources are mixed together, such as sunlight/shade and flash. (Default setting)
 Outdoors	Used when shooting in daylight under clear skies.
 Shade	Used when shooting in shade.
 Cloudy	Used when shooting in daylight under cloudy skies.
 Incandescent 1	Used with incandescent lighting.
 Incandescent 2	Takes an image a little redder than [Incandescent 1].
 Daylight Fl.	Used with daylight fluorescent lighting.
 Neutral White Fl.	Used with neutral white fluorescent lighting.
 Cool White Fl.	Used with cool white fluorescent lighting.

 Warm White Fl.	Used with warm white fluorescent lighting.
 CTE	Exaggerates the color of the light source to leave the color of the subject. Use this setting when you want to emphasize the color used for most part of the image.
 CT (color temperature)	Specifies the color temperature. (p.70)
 Manual	Adjusts the white balance manually. (p.70)

- 1** Press the **WB (▼)** button in shooting mode.  
The [White Balance] screen appears.

- 2** Press the **▲▼** buttons to select the setting.  
If no compensation is required, proceed to Step 6.  
When [CT] or [Manual] is selected, see p.70.



- 3** Press the **Fn2** button.  
The [White Balance Compensation] screen appears.

- 4** Press the **▲▼◀▶** buttons to make point adjustments.  
Press the **↶** button to reset. If the **↶** button is pressed again, the compensation is canceled.



- 5** Press the **MENU/OK** button.  
The screen in Step 2 reappears.

## 6 Press the MENU/OK button.

The shooting screen reappears and the symbol is displayed on the screen.



### Note

- The settings can also be made in [White Balance] of the [Shooting] menu.
- [Multi-P AUTO] works as [Auto] in the following cases.
  - In  mode
  - In Continuous Mode
  - When [Auto Bracket] is set to [AE-BKT 1/3EV], [AE-BKT 1/2EV], or [DR-BKT]



### Caution

- The white balance may not be adjusted correctly for a subject that is mostly dark.
- When using a flash, set the white balance to [Auto], [Multi-P AUTO], or [Manual]. The white balance may not be adjusted correctly for other settings.

## Setting the Color Temperature

- 1** Select [CT] in Step 2 on p.68, and then press the Fn2 button.

The [White Balance Detailed Settings [CT]] screen appears.

- 2** Press the ▲▼ buttons to set a value.

Values from 2500 K to 10000 K can be set.

If the Fn2 button is pressed, the white balance compensation can be performed. If the Fn2 button is pressed again, the screen returns to the color temperature settings.



- 3** Press the MENU/OK button.

The [White Balance] screen reappears.

- 4** Press the MENU/OK button.

The shooting screen reappears.

## Setting the White Balance Manually

- 1** Select [Manual] in Step 2 on p.68.

- 2** Aim the camera at a white subject, such as a sheet of paper, under the light for shooting.

- 3** Press the Fn2 button.

The white balance is measured.

If the Fn2 button is pressed while the flash is being fired, the white balance for flash shooting can be measured.

- 4** Press the MENU/OK button.

The shooting screen reappears.



## Shooting Continuously

The continuous shooting functions are as follows.

Continuous Mode	Continues to take pictures for as long as you hold down the shutter release button.	p.72
Auto Bracket	Takes three images with different exposure, white balance, effect, dynamic range, or contrast settings.	p.73
Multiple Exposure Shooting	Merges multiple images together.	p.74
Interval Shooting	Take pictures automatically at a fixed interval.	p.76
Interval Composite	Merges a series of continuous images in such a way that the bright areas remain.	p.77



### Caution

- Of the functions described above, only [Auto Bracket] and [Interval Shooting] can be used in combination. The other functions cannot be set at the same time.

## Shooting Continuously

Set [Continuous Mode] of the [Shooting] menu to [Continuous] to perform continuous shooting.

Pictures continue to be taken for as long as you hold down the shutter release button. The autofocus is fixed in the first frame.

When [Continuous] is set, the symbol appears on the shooting screen.

Set [Continuous Mode] to [Off] to return to normal shooting.

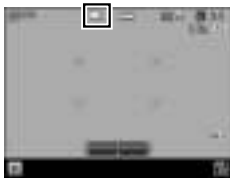

### Caution

- The flash cannot be used with this function.
- The self-timer cannot be used with this function.
- If the [Effect] of the [Shooting] menu is set to [Hi-Contrast B&W], [Miniaturize], [Clarity], or [Brilliance], continuous shooting is not available.
- If the [Picture Format] of the [Shooting] menu is set to **RAW** or **RAW+**, the continuous shooting stops when the camera memory capacity for processing reaches full.









### Note

- Continuous shooting can also be performed by holding the AF button down while fully pressing the shutter release button (Continuous AF). See “When the AF Function Switching Lever is Set to C-AF” (p.62) of “Using the AF Button”.
- The maximum number of pictures that can be taken continuously for one press of the shutter release button is 999.
- In the [Key Custom Options] menu, [Cont. Mode] can be registered to use to the ADJ. lever and the Fn1, Fn2, and Effect buttons. (p.120, p.122)

## Shooting Continuously with Different Settings (Auto Bracket)

In the [Auto Bracket] settings in the [Shooting] menu, three images will be taken with differing values for exposure, white balance, etc.

 AE-BKT 1/3EV AE-BKT 1/2EV	Takes images at different exposures in 1/3-EV or 1/2-EV steps from -2.0 EV to +2.0 EV.
 WB-BKT	Takes three images (an image with more reddish than the current white balance, an image at the current white balance, and an image with more bluish than the current white balance).
 WB-BKT Preset	Takes three images with different white balance settings. The white balance for the second and third images is selected, respectively.
 Effect-BKT	Takes three images with different effect settings. The effect for the second and third images is selected, respectively.
 DR-BKT	Takes images with the dynamic range compensation set to [Off], [Weak], and [Strong].
 CONTRAST-BKT	Takes images with different contrast settings.



### Caution

- The flash cannot be used with this function.
- [AE-BKT 1/2EV] cannot be selected in Tv mode.
- When [Effect] of the [Shooting] menu is set to [Miniaturize], [Clarity], or [Brilliance], [AE-BKT 1/3EV], [AE-BKT 1/2EV], and [DR-BKT] cannot be used.
- [Shift Crop] cannot be selected for [Effect-BKT].



### Note

- In the [Key Custom Options] menu, [Auto Bracket] can be registered to use to the ADJ. lever and the Fn1, Fn2, and Effect buttons. (p.120, p.122)

## Shooting Continuously with Varied Exposure Values

- 1 In [Auto Bracket] of the [Shooting] menu, select [AE-BKT 1/3EV] or [AE-BKT 1/2EV], and then press the ► button.

The [AE Bracketing Settings] screen appears.

- 2 Press the ◀► buttons to select from the first through third image, and then press the ▲▼ buttons to set the exposure value.



- 3 Press the MENU/OK button twice.

The shooting screen reappears.

## Shooting While Merging Images Together (Multiple Exposure Shooting)

The camera takes images while merging them together. Up to five images can be merged.

- 1 In the [Shooting] menu, select [Multiple Exposure Shooting], and then press the ► button.

The [Multiple Exposure Shooting] screen appears.

- 2 Press the ▲▼ buttons to select items, and then set the selected item to [On] or [Off].



Automatic Exposure	[Off]: Does not adjust the exposure value.
	[On]: Merges images while adjusting the exposure value depending on the number of images.
Save Each Image	[Off]: Saves only the final merged image.
	[On]: Saves each unmerged image.
Save in process	[Off]: Saves only the final merged image.
	[On]: Saves each merged image.

### 3 Press the MENU/OK button.

[Multiple Exposure Shooting] appears on the shooting screen.

### 4 Take the first image.

### 5 To take the next image, select [Next shot >], and then press the MENU/OK button.

To retake the image, select [Retake shot].



### 6 Take the next image.

Repeat Steps 5 and 6.

To return to the previous merged image, select [Retake shot]. To end multiple exposure shooting, select [Complete].

When shooting ends after the fifth image is taken or when [Complete] is selected, the merged image is saved.



#### Note

- If [Multi Exposure] is set to the Fn1, Fn2, and Effect buttons in the [Key Custom Options] menu, you can start the multiple exposure shooting with button operation only. (p.122)



#### Caution

- The settings for the following functions cannot be changed during the multiple exposure shooting.
  - Crop
  - Effect/Image Settings

## Shooting Automatically at Set Intervals (Interval Shooting)

The camera takes pictures automatically at fixed intervals.

- 1** In the [Shooting] menu, select [Interval Shooting], and then press the **▶** button.

The [Interval Shooting] screen appears.

- 2** Press the **◀▶** buttons to select minutes/seconds, and then press the **▲▼** buttons to set the interval value.

You can select the shooting interval from 1 second, 2 seconds, or between 5 seconds and 60 minutes (in 5-second increments).



- 3** Press the **◀▶** buttons to select the number of pictures, and then press the **▲▼** buttons to set the value.

Values from 1 to 99 or ∞ can be set.

- 4** Press the MENU/OK button.

[Interval Shooting] appears on the screen.

- 5** Press the shutter release button to take the picture.

A picture is taken every time the set interval elapses.

- 6** Press the MENU/OK button to end shooting.

### **⚠** Caution

- Depending on the shooting settings, the time until the next picture is taken may be longer than the time set for interval shooting.
- When the shooting interval is set to 1 second or 2 seconds, the exposure for the first image may be used for the second and later images.
- The interval shooting is canceled if the power is turned off.

### **📌** Note

- When [Focus] of the [Shooting] menu is set to [Subj. Tracking], the focus method becomes [Multi AF] during the interval shooting.
- It is recommended to use the battery with sufficient power.
- It is recommended to use a memory card with sufficient free space or a high speed memory card.

## Recording Star Trails (Interval Composite)

A series of continuous images taken at set intervals is merged in such a way that the bright areas remain. Use this function when you want to record the trails of light formed by stars or the moon during nightscape shooting at a fixed position.

- 1 Mount the camera on a tripod.**
- 2 Set the mode dial to Av, Tv, TAv, or M, and then take a test shot.**  
Set the aperture value, shutter speed, focus, ISO sensitivity, and white balance, and then check the composition. This exposure is maintained in images are merged.
- 3 In the [Shooting] menu, select [Interval Composite].**
- 4 Press the ▲▼ buttons to select an item, and then change its setting.**



Interval	Sets the shooting interval from the shortest value (Min.) up to 60 minutes.
Save Interval Composite Img.	Sets how the images are saved. [Off]: Saves only the merged image. [Save Each Image]: Saves both the unmerged image and merged image in JPEG format. [Save in process]: Saves each image at the point it is merged in JPEG format.

- 5 Press the MENU/OK button.**  
[Interval Composite] appears on the shooting screen.

## 6 Press the shutter release button fully.

The first image is taken, and additional images are taken continuously at the set interval.

To check the images being merged, press the shutter release button halfway. If the shutter release button is pressed fully, the images merged up to that point are saved as they are, and the interval composite shooting starts with a new image.

## 7 Press the MENU/OK button to end shooting.

The merged image is saved.



### Caution

- The image at the time of pressing the MENU/OK button during shooting is not merged.
- The flash cannot be used with this function.
- The ISO sensitivity cannot be set to higher than ISO 1600.
- The shutter speed cannot be set to longer than 60 seconds.
- For the RAW images taken with Interval Composite when [Ambient Brightness] of the [Shooting] menu is set to [Normal], [Original] cannot be selected for [Ambient Brightness] of [RAW Development] of the [Playback] menu.
- [Vignetting] set in [Effect] or [Image Settings] of the [Shooting] menu is invalid.











### Note

- The values of the following settings are fixed when the first image is taken.
  - ISO sensitivity when set to [Auto] or [Auto-Hi]
  - White balance value when set to [Auto]
- AF operation is only performed for the first image.
- When [Focus] of the [Shooting] menu is set to [Subj. Tracking], it works as [Multi AF] during the interval composite shooting.
- The self-timer can only be used for the first image. [Custom Self-Timer] cannot be used.
- If shooting the light trails of stars, setting the [Focus] of the [Shooting] menu to [ $\infty$ ] and the [Interval] to [Min.] will yield clear images. Also, when taking test shots, check that the stars appear as points of light. Those points of light will be recorded as light trails when merged.
- During shooting in a dark location, using the optional external viewfinder (GV-1/GV-2) is convenient.



## Using the Flash

### Setting the Flash Mode

 Auto	Automatically fires the flash when the subject is poorly lit or backlit. (Default setting)
 Flash On	Always fires the flash.
 Flash Synchro.	Fires the flash with the shutter speed slowed. Use when taking nightscape pictures that include people. Use of a tripod is recommended to prevent blur.
 Manual Flash	Fires the flash with intensity set in [Manual Flash Amount] of the [Shooting] menu. (p.82)
 Red-Eye Flash Auto	Reduces "red-eye" in portraits taken with the flash.
 Red-Eye Flash On	Forces the flash to fire while reducing the red-eye phenomenon.
 Red-Eye Flash Synchro.	Fires the flash with the shutter speed slowed while reducing the red-eye phenomenon.
 Wireless	Fires the PENTAX auto flash (AF540FGZ II, AF360FGZ II, AF540FGZ, or AF360FGZ) placed separately from the camera. (p.168)

- 1** Slide the  OPEN switch downward.  
The flash opens.

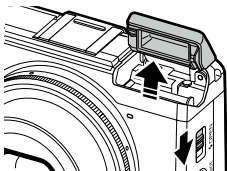

## 2 Press the button.

The flash mode setting screen appears.

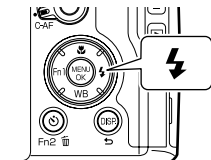

## 3 Press the buttons to change the flash mode.

The symbol appears on the shooting screen.



### Note

- If the ISO sensitivity is set to [Auto], the range the flash light will reach is approximately 20 cm to 3.0 m from the front edge of the lens.
- The flash fires a pre-flash to increase the AE accuracy. The pre-flash does not fire when set to [Manual Flash].
- The flash intensity can be adjusted in [Flash Exposure Compensation] of the [Shooting] menu. (p.81)
- For the external flash, see p.167.



### Caution

- The flash mode cannot be changed when the flash cover is closed.
- The flash does not fire in the following cases.
  - In Continuous Mode
  - During Auto Bracket
  - During Interval Composite
  - In  mode
- Do not open the flash if using an external flash, conversion lens, or hood.

## Adjusting the Intensity of the Flash

The intensity of the flash can be adjusted.

- 1** In the [Shooting] menu, select [Flash Exposure Compensation], and then press the **▶** button.

The [Flash Exposure Compensation] screen appears.

- 2** Press the **+/-** button to set a value.

The intensity can be set in the range from -2.0 EV to +2.0 EV in increments of 1/3 EV.



- 3** Press the MENU/OK button.

The set value appears on the shooting screen.

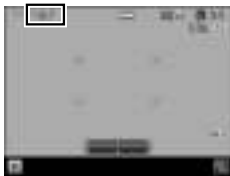

### Note

- When the flash mode is set to [Manual Flash], the value set for [Flash Exposure Compensation] is invalid.
- In the [Key Custom Options] menu, [Flash Comp.] can be registered to use the ADJ. lever and the Fn1, Fn2, and Effect buttons. (p.120, p.122)

## Setting the Flash Intensity for Manual Flash

The intensity of the internal flash can be set for when the flash mode is set to [Manual Flash].

**1** In the [Shooting] menu, select [Manual Flash Amount], and then press the ► button.

**2** Press the ▲▼ buttons to select a value.

You can select from the following fractions of the maximum flash intensity: [Full], [1/1.4], [1/2], [1/2.8], [1/4], [1/5.6], [1/8], [1/11], [1/16], [1/22], [1/32], and [1/64].

**3** Press the MENU/OK button.

If the flash mode is set to [Manual Flash], the set value appears on the shooting screen.

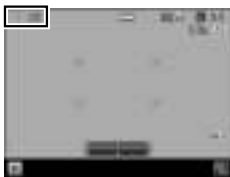

### Note

- In the [Key Custom Options] menu, [Flash Amount] can be registered to use to the ADJ. lever and the Fn1, Fn2, and Effect buttons. (p.120, p.122)

## Setting the Timing for Firing the Flash

You can set the timing at which the flash fires in [Flash Synchro Settings] of the [Shooting] menu.

1st Curtain	Fires the flash immediately after the exposure starts. (Default setting)
2nd Curtain	Fires the flash just before the exposure ends. When shooting a subject in motion at a low shutter speed, this makes it possible to naturally express the subject's motion as a trail of light.







# Taking Images with Unique Atmosphere

Images with varied saturation and contrast can be taken.

## Effect

The settings such as the hue can be changed to take distinctive images.

 Black & White	Takes a black and white image. The [Contrast], [Sharpness], and [Vignetting] can be set.
 B&W (TE)	Adds tint to black-and-white images. The [Toning Effect], [Saturation], [Contrast], [Sharpness], and [Vignetting] can be set.
 Hi-Contrast B&W	Takes images with stronger contrast than [Black & White]. Makes it possible to take images with a grainy feel, such as that created by using ultra-high-sensitivity film in a film camera or by push processing film at the development stage. The [Contrast], [Sharpness], and [Vignetting] can be set.
 Cross Process	Takes images with tones that differ from the actual colors. The [Hue], [Saturation], [Contrast], [Sharpness], and [Vignetting] can be set.
 Positive Film	Takes highly saturated images like those taken with positive film. The [Saturation], [Contrast], [Sharpness], and [Vignetting] can be set.
 Bleach Bypass	Takes images with low saturation and high contrast. The [Hue], [Saturation], [Contrast], [Sharpness], and [Vignetting] can be set.
 Retro	Takes images that look like old photos. The [Saturation], [Contrast], [Sharpness], and [Vignetting] can be set.
 Miniaturize	Takes images that make the landscape look as if it has been miniaturized. The [Toning Effect], [Saturation], [Contrast], [Sharpness], and the position and range of blurring in the image can be set. (p.87)
 Shift Crop	Cuts out the upper or lower area of the image with a ratio of width to length of 1:1 when the camera is held vertically. You can select which area to cut out with the Fn2 button.
 High Key	Takes images with a bright atmosphere. The [Saturation] can be set.

 HDR Tone	Takes images finished like a painting with enhanced fine contrast. The [Toning Effect], [Saturation], and [Vignetting] can be set.
 Clarity	Takes images with enhanced subject texture and surface details. The [Toning Effect], [Clarity], [Saturation], and [Vignetting] can be set.
 Brilliance	Takes images with adjusted subject brilliance. The [Brilliance], [Saturation], [Contrast], [Sharpness], and [Vignetting] can be set.
 Slight	Takes slightly colored images. The [Saturation], [Contrast], [Sharpness], and [Vignetting] can be set.
 Vibrant	Takes images with quaint and vibrant shades of color. The [Saturation], [Contrast], [Sharpness], and [Vignetting] can be set.
 Bright	Takes sharp images. The [Saturation], [Contrast], [Sharpness], and [Vignetting] can be set.
 Portrait	Takes images with optimum color for human skin. The [Saturation], [Contrast], [Sharpness], and [Vignetting] can be set. The focus mode changes to "Face recognition priority AF".

- 1** In the [Shooting] menu, select [Effect], and then press the **▶** button.
- 2** Press the **▲▼** buttons to select the setting.
- 3** Press the Fn2 button.
- 4** Press the **▲▼** buttons to select the item, and then press the **◀▶** buttons to set the value.



- 5** Press the MENU/OK button twice.  
The symbol appears on the shooting screen.

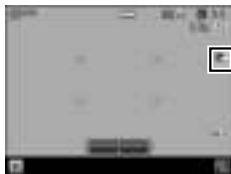

**Caution**

- If [Effect] is set, the settings for [Image Settings] are invalid.
- [Vignetting] cannot be set in mode.
- If [Interval Composite] is set in the [Shooting] menu, [Vignetting] is invalid.
- Settings made in [Effect] are not applied to RAW images.
- [Effect] cannot be used with the following functions.

Function	Effect
mode	Shift Crop
mode	Hi-Contrast B&W, Miniaturize, Shift Crop, High Key, HDR Tone, Clarity, Brilliance
Multiple Exposure Shooting, Interval Composite	Miniaturize, HDR Tone, Clarity, Brilliance

- Depending on the effects that have been set, the following functions become invalid.

Effect	Invalid function
Hi-Contrast B&W	Continuous Mode
Hi-Contrast B&W, Cross Process, Positive Film, Bleach Bypass, Retro, Miniaturize	Focus ([Subj. Tracking])
Miniaturize, HDR Tone, Clarity, Brilliance	Continuous Mode, Auto Bracket ([AE-BKT 1/3EV], [AE-BKT 1/2EV], [DR-BKT])
Shift Crop	Focus ([Multi AF], [Spot AF], [Subj. Tracking]), Continuous AF, Auto Bracket ([Effect-BKT])

- When [Vignetting] is set, the speed for [Continuous Mode] becomes slow.

**Note**

- In the [Key Custom Options] menu, [Effect] can be registered to use to the ADJ. lever and the Fn1, Fn2, and Effect buttons. (p.120, p.122)  
[Effect] is registered to the Effect button as the default setting.



## Shooting with Miniaturize

Images that give the impression that they are close-ups of a miniature can be taken. This mode is effective when shooting from a high vantage point while looking down at a diagonal angle.

### 1 In [Effect] of the [Shooting] menu, select [Miniaturize].

To change settings such as [Toning Effect], press the Fn2 button.

### 2 Press the MENU/OK button.

The miniaturize shooting screen appears.

The areas outside of the unblurred (focus area) are shown in a semi-transparent gray.

### 3 Press the Fn2 button.

The screen for setting the position and range of blurring appears.

### 4 Press the ▲▼ buttons to move the position of the focus area.

Change the vertical/horizontal orientation of the focus area by pressing the Fn2 button while this screen is displayed.

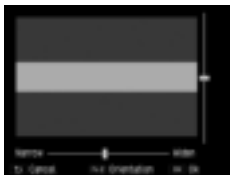

### 5 Press the ◀▶ buttons to set the width of the focus area.

### 6 Press the MENU/OK button.

The shooting screen reappears.





#### Note

- The amount of blurring in the image shown on the confirmation screen immediately after shooting differs slightly from that of the actual image.

## Image Settings

Images can be taken with adjusted saturation, contrast, sharpness, and vignetting.

 Vivid	Increases the contrast, sharpness, and saturation beyond [Standard] for an image quality that feels solid.
 Standard	Takes images with normal image quality.
 Setting1/Setting2	The [Saturation], [Contrast], [Sharpness], and [Vignetting] can be set.

**1** In the [Shooting] menu, select [Image Settings], and then press the **▶** button.

**2** Press the **▲▼** buttons to select the setting.  
When [Vivid] or [Standard] is selected, proceed to Step 6.

**3** Press the Fn2 button.

**4** Press the **▲▼** buttons to select the item, and then press the **◀▶** buttons to set the value.



**5** Press the MENU/OK button.  
The screen in Step 2 reappears.

**6** Press the MENU/OK button.  
The symbol appears on the shooting screen.

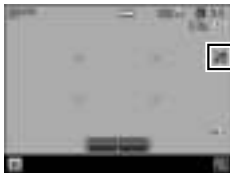

**Caution** -----

- Settings made in [Image Settings] are not applied to RAW images.
- If [Interval Composite] is set in the [Shooting] menu, [Vignetting] is invalid.

**Note** -----

- In the [Key Custom Options] menu, [Image Settings] can be registered to use to the ADJ. lever and the Fn1, Fn2, and Effect buttons. (p.120, p.122)

## Changing the Ambient Brightness

In [Ambient Brightness] of the [Shooting] menu, [Original] or [Normal] can be selected. If [Ambient Brightness] is set to [Original], you can take pictures with the ambient light quantities comparable to those of the GR film cameras.

The symbol appears on the shooting screen when [Original] is selected.

**Note** -----

- The RAW images can be developed with [Normal] or [Original] setting in [RAW Development] of the [Playback] menu. The RAW images taken with Interval Composite when [Normal] is selected cannot be developed with [Original] setting.

**Caution** -----

- The ambient brightness cannot be changed in  mode.
- When [Crop] is set in the [Shooting] menu, the [Ambient Brightness] setting may be ineffective.

## Other Shooting Functions

### Adding the Date to Still Images

If [Date] or [Date and Time] is selected in [Date Imprint] of the [Shooting] menu, either the date (Year/Month/Day) or the date and time (Year/Month/Day Hour:Minute) is imprinted on the lower-right corner of still images.

The symbol appears on the shooting screen when [Date Imprint] is on.











#### Caution

- [Date Imprint] is not available if the date and time have not been set. Set the date and time beforehand. (p.29)
- The date cannot be imprinted on RAW images or movies.
- The date imprinted in an image cannot be deleted.

# Recording Movies



Movies with sound can be recorded.  
Movies are recorded as MOV files.

## Setting the Movie Format

- 1 Turn the mode dial to .**  
The mode switches to  mode.
- 2 Press the MENU/OK button.**  
The [Shooting] menu of the  mode appears.
- 3 Select [Movie Format], and then press the  button.**
- 4 Press the     buttons to select [Still Image Size] or [Frame Rate].**



The following settings are available. The frame rates that can be selected depend on the [Still Image Size] setting.

Still Image Size	Frame Rate (frames/second)				
	60	50	30	25	24
 Full HD (1920 × 1080)	No	No	Yes	Yes	Yes
 HD (1280 × 720)	Yes	Yes	Yes	Yes	Yes
 VGA (640 × 480)	No	No	Yes	Yes	Yes

- 5 Press the MENU/OK button twice.**  
The shooting screen reappears.



### Note

- In the [Key Custom Options] menu, [Frame Rate] can be registered to use to the Fn1, Fn2, and Effect buttons. (p.122)
- The screen may flicker if shooting under fluorescent lighting. The amount of flickering can be minimized by setting the power frequency for your region in [Reduce Fluorescent Flicker] of the [Shooting] menu in  mode.

## Recording Movies

**1** Turn the mode dial to .

**2** Press the shutter release button.

Movie recording starts.

While recording, the “●REC” indicator, recording time, and time remaining are displayed.



**3** Press the shutter release button again.

Recording ends.



### Caution

- If the camera is operated while shooting, the operation sounds are also recorded.
- The following functions are not available in  mode.
  - Flash
  - FA/Move Target



### Note

- If the Fn2 button is pressed while shooting, recording is paused. If the Fn2 button is pressed again, recording resumes.
- Each movie can be a maximum of 25 minutes long or up to 4 GB in size.
- The maximum recording time per shooting depends on the capacity of the memory card. (p.164) Shooting may end even before the maximum recording time is reached.
- The amount of time remaining is calculated based on the amount of memory available and may not diminish at an even rate.
- Use a memory card of Speed Class 6 or higher for recording movies.
- Use the battery with sufficient power.

## Playing Back Movies

### 1 Press the button.

The mode switches to playback mode.

### 2 Press the buttons to select a movie.

Movies are indicated by  icon.

The first frame of the movie is displayed as a still image.

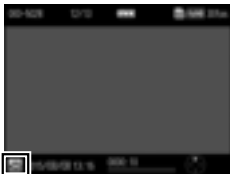





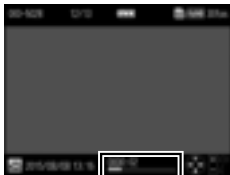

### 3 Press the button.

Playback starts.

The progress indicator and elapsed time are displayed.



You can perform the following operations.

 button	Pauses and resumes playback.
 button	Stops playback.
 button	Adjusts the volume.
  buttons	While playback is paused: Reverses and forwards a frame.
  buttons	During playback: Fast-reverses and fast-forwards playback.
Fn2 button	While playback is paused: Saves a still image in JPEG format.



#### Note

- The speed for Fast Forward and Fast Rewind switches each time the button is pressed.

## Clipping Movies

The unnecessary parts at the beginning or end of a movie can be deleted, and the movie can be saved as a new file.

- 1** Display the movie to be edited in playback mode, and then press the MENU/OK button.

The [Playback] menu appears.

- 2** Select [Clip Movie File], and then press the ► button.

The [Clip Movie File] screen appears.

- 3** Press the ADJ. lever to select either the beginning or the end of the movie.

The point highlighted in yellow indicates which has been selected.

If the Fn2 button is pressed while this screen is shown, an explanation of the operations appears. If the Fn2 button is pressed again, the previous screen reappears.



- 4** Press the ◀▶ buttons or the ADJ. lever left or right to move the point to be deleted.

The yellow point moves. You can specify the point in increments of 1 second.

- 5** Press the MENU/OK button.

A new movie file is saved with the unnecessary parts deleted.



### Displaying Images in Thumbnail View

Pressing the  $\mathcal{Q}$  (+)/ $\mathcal{Q}$  (-) button in playback mode displays multiple images in thumbnail view.



In thumbnail view, you can perform the following operations.

$\blacktriangle$ $\blacktriangledown$ $\blacktriangleleft$ $\blacktriangleright$ buttons	Selects an image.
ADJ. lever	Displays the selected image in single image view.
DISP. button	Changes between single image selection and page selection.

### Displaying Images in a Slide Show

You can display taken images sequentially.

Select [Slide Show] in the [Playback] menu, and then press the  $\blacktriangleright$  button to start a slide show.

If you want to stop the slide show in progress, press any button. The slide show is displayed repeatedly until stopped.



**Note** -----

- Each still image is displayed for three seconds.
- In the case of a movie, all of the frames of the movie are played back and then the next image is displayed.

## Displaying Images in Enlarged View

You can display still images enlarged.



In single image view, you can perform the following operations.

Q (+) button/ Up-down dial to the right	Enlarges the image.
☒ (-) button/ Up-down dial to the left	In enlarged view: Reduces the image.
▲▼◀▶ buttons	In enlarged view: Moves the enlarged area.
Pushing down the ADJ. lever/ MENU/OK button (in enlarged view)	Enlarges the image to the magnification (4×, 8×, or 16×) set in [One Press Zoom Ratio] of the [Setup] menu.
Pressing the ADJ. lever left or right	In enlarged view: Displays the previous or next image without changing the magnification (returns to actual size in the case of a movie).
DISP. button	In enlarged view: Turns the information display on/off.



### Note

- If you set [Target Zoom Play] of the [Setup] menu to [On], the image is enlarged centering on the position to which the target shifted during shooting.
- The maximum magnification of enlarged view differs depending on the size of the image.
- Movies cannot be enlarged.
- The functions of the up-down dial and ADJ. lever during playback mode can be changed in [Playback Mode Dial Options] of the [Key Custom Options] menu.

	Up-down dial	ADJ. lever
Setting1 (Default setting)	Displays enlarged view.	Displays next/previous enlarged frame.
Setting2	Moves enlarged area up/down.	Moves enlarged area left/right.



## Organizing Files



### Deleting Files

#### Deleting One File

**1** Display the image to delete in playback mode.

**2** Press the  button.

**3** Press the   buttons to select [Delete One].

You can change the image with the   buttons.

For images taken with **RAW+**, [Delete RAW+JPEG], [Delete JPEG Only], and [Delete RAW Only] can be selected.



**4** Press the MENU/OK button.



The image is deleted.

To delete another image, repeat Steps 3 and 4.

To end the process, select [Cancel].

#### Deleting All Files

**1** Press the  button in playback mode.

**2** Press the   buttons to select [Delete All] and then press the MENU/OK button.

The deletion confirmation screen appears.

**3** Press the  button to select [Yes], and then press the MENU/OK button.

#### Deleting Multiple Files Simultaneously

**1** Press the  button in playback mode.

When in 20-image or 81-image view, proceed to Step 3.

- 2 Select [Delete Multi], and then press the MENU/OK button.
- 3 Select [Sel. Individ.] or [Sel. Range], and then press the MENU/OK button.
- 4 Press the **▲▼◀▶** buttons to select images, and then press the MENU/OK button.

The trash symbol is displayed in the bottom left corner of the thumbnail.

If [Sel. Range] is selected, select the image that is the starting point of the range.

If the ADJ. lever is pressed, the selection screen in Step 3 reappears.

If [Sel. Individ.] is selected, proceed to Step 6.

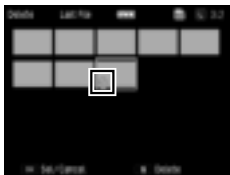

- 5 Press the **▲▼◀▶** buttons to select the image that is the ending point of the range, and then press the MENU/OK button.

Repeat Steps 4 and 5 to specify all of the ranges.

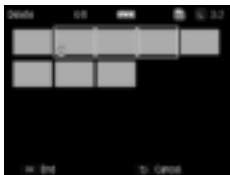

- 6 Press the **🗑️** button.

The deletion confirmation screen appears.

- 7 Press the **▶** button to select [Yes], and then press the MENU/OK button.

A message appears to indicate processing is being performed, and then the previous screen reappears when deleting is complete.

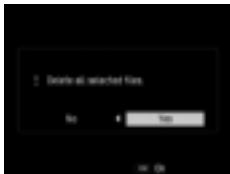

#### Note

- A folder cannot be deleted.

## Setting Protection

You can protect images to prevent them from being deleted accidentally.



### Caution

- If you select [Format] in the [Setup] menu, protected images are also deleted.

## Setting Protection for One File

- 1** Display the image to protect in playback mode, and then press the MENU/OK button.

The [Playback] menu appears.

- 2** Select [Protect], and then press the ► button.

- 3** Press the ▲▼ buttons to select [1 File].

You can change the image with the ◀▶ buttons.



- 4** Press the MENU/OK button.

Protection is set and the symbol appears on the playback screen.

Performing the same operation for the protected image cancels protection.



## Setting/Canceling Protection for All Files

- 1** Select [Protect] in the [Playback] menu, and then press the ► button.

- 2** Select [Select All] or [Cancel All], and then press the MENU/OK button.

## Setting Protection for Multiple Files Simultaneously

- 1** Select [Protect] in the [Playback] menu, and then press the ► button.

When in 20-image or 81-image view, proceed to Step 3.

- 2** Select [Sel. Multiple], and then press the MENU/OK button.

- 3** Select [Sel. Individ.] or [Sel. Range], and then press the MENU/OK button.

- 4** Press the ▲▼◀▶ buttons to select images, and then press the MENU/OK button.

The protection symbol is displayed in the top right corner of the thumbnail.

If [Sel. Range] is selected, select the image that is the starting point of the range.

If the ADJ. lever is pressed, the selection screen in Step 3 reappears.

If [Sel. Individ.] is selected, proceed to Step 6.

- 5** Press the ▲▼◀▶ buttons to select the image that is the ending point of the range, and then press the MENU/OK button.

Repeat Steps 4 and 5 to specify all of the ranges.

If you select images with protection already set, protection is canceled.

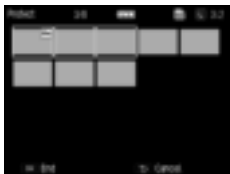

- 6** Press the Fn2 button.

A message appears to indicate processing is being performed, and then the previous screen reappears when the setting is complete.

## Copying the Images and Movies in the Internal Memory to a Memory Card

You can copy the still images and movies stored in the internal memory to a memory card.

**1** Insert a memory card.

**2** Select [Copy to Card from Internal Memory] in the [Playback] menu, and then press the ► button.

A message appears to indicate processing is being performed, and then the previous screen reappears when copying is complete.



**Caution** -----

- If there is not enough space available on the copy destination memory card, a message indicating that there is insufficient space appears.
- Copying from a memory card to the internal memory is not possible.

## Correcting and Processing Images

You can correct and process taken images and then save them as new images.



### Caution

- Only JPEG images taken with this camera can be corrected and processed. RAW images, movies, and still images saved from movies cannot be corrected and processed.
- If you correct and process images repeatedly, image quality will deteriorate.

## Reducing the Size of Images

You can reduce the size of still images to **S** or **XS** by selecting [Resize] in the [Playback] menu.

## Trimming Images

You can trim the edges of images and then save the images.

**1**

Display the image to trim in playback mode, and then press the MENU/OK button.

The [Playback] menu appears.

**2**

Select [Trim], and then press the ► button.

**3**

Specify the range to trim.



You can perform the following operations.

+/- button	Changes the trimming size.
▲▼◀▶ buttons	Moves the trimming frame.
ADJ. lever	Changes the aspect ratio of the trimming frame (4:3, 3:2, or 1:1).
Fn2 button	Displays the operating procedure.

**4**

Press the MENU/OK button.

The trimmed image is saved as a new image.



**Note** -----

- The image size after trimming differs depending on the size of the original image and the size of the trimming frame.

## Correcting Skewed Images

You can correct images of rectangular objects such as message boards and business cards taken at an angle so that the images appear as if they were taken from the front.

### 1 Display the image to correct in playback mode, and then press the MENU/OK button.

The [Playback] menu appears.

### 2 Select [Skew Correction], and then press the ► button.

A message appears to indicate processing is being performed, and then up to five areas recognized as correction targets are indicated by yellow frames.

If an area could not be detected, an error message appears.

### 3 Press the ◀▶ buttons to select a correction area.

To cancel the correction, press the ↶ button.



### 4 Press the MENU/OK button.

Screw correction is performed for the selected area, and then the portions outside the frame are trimmed.

**Caution** -----

- The time for skew correction increases with image size.

## Correcting Brightness and Contrast (Level Compensation)

You can correct the brightness and contrast of taken still images.

- 1** Display the image to correct in playback mode, and then press the MENU/OK button.

The [Playback] menu appears.

- 2** Select [Level Compensation], and then press the ► button.

- 3** Select [Auto] or [Manual], and then press the ► button.

The original image is displayed on the top left, and the corrected image on the right.

If you select an image that cannot be corrected, an error message appears and then the [Playback] menu reappears.

When [Auto] is selected, proceed to Step 6.

- 4** Press the ADJ. lever to switch the histogram points.

The points at the left side, center, and right side are switched.

The histogram indicates the number of pixels on the vertical axis, and the shadows, mid-tones, and highlights from left to right on the horizontal axis.

If the Fn2 button is pressed while this screen is shown, an explanation of the operations appears. If the Fn2 button is pressed again, the previous screen reappears.



Points

- 5** Press the ◀► buttons to make point adjustments.

- 6** Press the MENU/OK button.

A message appears to indicate processing is being performed, and then the corrected image is saved as a new image.



## Examples of Correction

### Adjusting the Overall Brightness

- Move the mid-point to the left to increase the overall brightness, and move it to the right to increase the overall darkness.

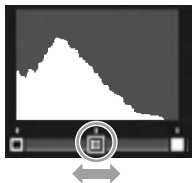

### Correcting an Overexposed or Underexposed Image

- If the image is overexposed, move the left side point to the right until it lines up with the left edge of the histogram.
- If the image is underexposed, move the right side point to the left until it lines up with the right edge of the histogram.
- In this state, you can move the mid-point left or right to adjust the overall brightness.

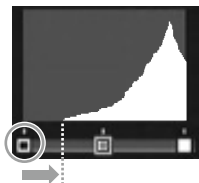

When overexposed

### Increasing the Contrast

- In an image lacking in contrast, the histogram peaks are concentrated at the center. Move the left and right points until they line up with both edges of the histogram respectively to make the bright and dark areas of the image stand out.
- In this state, you can move the mid-point left or right to adjust the overall brightness.

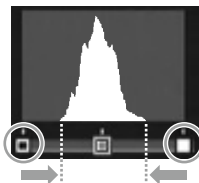

## Correcting the White Balance

You can correct the color tones of still images.

- 1** Display the image to correct in playback mode, and then press the **MENU/OK** button.

The [Playback] menu appears.

- 2** Select [White Balance Compensation], and then press the **▶** button.

The [White Balance Compensation] screen appears.

- 3** Press the **▲▼◀▶** buttons to make point adjustments.

To reset the white balance, press the **↶** button. If the **↶** button is pressed again, the compensation is canceled.

If the Fn2 button is pressed while this screen is shown, an explanation of the operations appears. If the Fn2 button is pressed again, the previous screen reappears.



- 4** Press the **MENU/OK** button.

A message appears to indicate processing is being performed, and then the corrected image is saved as a new image.

## Correcting Color Moire

You can reduce color interference caused by regular overlapping patterns in still images.

- 1** Display the image to correct in playback mode, and then press the MENU/OK button.

The [Playback] menu appears.

- 2** Select [Color Moire Correction], and then press the ► button.

- 3** Press the ▲▼ buttons to select [Weak], [Medium], or [Strong], and then press the MENU/OK button.

A message appears to indicate processing is being performed, and then the corrected image is saved as a new image.



### **Caution** -----

- Some images may not be able to be corrected properly.
- If you perform color moire correction, color loss or color bleeding may occur.

## Developing RAW Images

You can convert RAW images into JPEG format and then save them as new files. The white balance and effect can be configured before saving the files.

### 1 Display a RAW image in playback mode, and then press the MENU/OK button.

The [Playback] menu appears.

### 2 Select [RAW Development], and then press the ► button.

The [RAW Development] screen appears.

### 3 Press the ▲▼ buttons to select a parameter, and then press the ► button.



The following settings are available.

- Picture Size
- White Balance
- Brightness Compensation
- Effect
- Image Settings
- Dynamic Range Compensation
- Color Moire Correction
- Aspect Ratio
- Noise Reduction
- Color Space Setting
- Ambient Brightness

The settings that were set at the time of shooting are initially selected.

### 4 Press the ▲▼ buttons to select a setting, and then press the ◀ button.

With [White Balance], you can perform white balance compensation by pressing the ► button.

With [Effect] and [Image Settings], you can set the detailed settings by pressing the ► button.

### 5 When you have finished configuring all of the settings, press the MENU/OK button.

A new JPEG image is saved.

**Note** -----

- [Multi-P AUTO] or [Manual] of [White Balance] can only be selected if it was set at the time of shooting.
- For [Dynamic Range Compensation] and [Noise Reduction], select from [Off], [Weak], [Medium], and [Strong].
- For [Aspect Ratio], the images taken when [Picture Format] is set to [3:2] can be selected.
- For RAW images taken using [Shift Crop] of [Effect], you cannot select the effects other than [Shift Crop]. Also, [Shift Crop] cannot be set to RAW images taken with other effects.
- You can develop RAW images on a computer using the “Digital Camera Utility 5” software supplied with the camera. (p.130)

**Caution** -----

- For the RAW images taken with Interval Composite when [Ambient Brightness] is set to [Normal], you cannot change the ambient brightness setting to [Original].

## Viewing Images with an AV Device

You can connect the camera to a TV or other AV device to play back images on the device.

Purchase an optional cable that is compatible with the video input terminal(s) of the device to be connected.

AV device terminal	Cable	Camera terminal
Video terminal	AV cable (AV-1)	USB/AV OUT terminal
HDMI terminal	HDMI cable (HC-1)	HDMI micro output terminal

- 1** Connect the cable to the video input terminal of the AV device.
- 2** Make sure that the camera power is off.
- 3** Open the camera terminal cover and connect the cable.

Connect the cable to either the USB/AV OUT terminal or the HDMI micro output terminal.

USB/AV OUT terminal

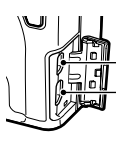

HDMI micro output terminal

- 4** Switch the input of the AV device to the input with the camera connected.

For details, refer to the operating manual for the AV device.

- 5** Turn on the power of the camera.



**Caution** -----

- The picture display is off while the camera is connected with an AV cable or HDMI cable.
- The audio of the video is output from the AV device. Adjust the volume on the AV device.
- The highlight alert is not shown when connected with an HDMI cable.



**Note**-----

- When connecting with an AV cable, confirm the video format of the AV device. The default video format setting of the camera varies depending on the country or region where you purchased it. To change the video format setting, set in [Video Out Mode] of the [Setup] menu.
- The view switches to single image view when an HDMI cable is connected or disconnected.
- The resolution is set to [AUTO] during HDMI output. If the resolution of the images displayed on the AV device is low, change the setting in [HDMI Output] of the [Setup] menu.

## Setting DPOF

You can order prints of the still images stored on the memory card at a store with a print service.

- 1** Display the image to set in playback mode, and then press the MENU/OK button.

The [Playback] menu appears.

- 2** Select [DPOF], and then press the ► button.

- 3** Use the ▲▼ buttons to select [1 File] or [Select All].

If [1 File] is selected, use the ◀▶ buttons to select an image. Selecting [Cancel All] cancels the DPOF setting for all images.

- 4** Press the MENU/OK button.

DPOF is set and the symbol appears on the playback screen.



### Caution

---

- DPOF cannot be set in the following cases.
  - RAW images
  - Movies
  - Images stored in the internal memory
  - Images in a locked memory card

## Setting DPOF for Multiple Still Images

You can specify multiple images and the number of copies from thumbnail view.

- 1** Press the **—** button in playback mode.

The screen changes to 20-image view.

- 2** Select [DPOF] in the [Playback] menu, and then press the **▶** button.

- 3** Press the **◀▶** buttons to select an image to print, and then use the **▲▼** buttons to specify the number of copies.

The symbol indicating the DPOF setting appears.

To cancel the setting, specify [0] for the number of copies.



- 4** Press the **MENU/OK** button.

A message appears to indicate processing is being performed, and then the 20-image view reappears when the setting is complete.

### Customizing the Camera

You can change the functions of the Fn buttons and ADJ. lever, and register settings to MY1, MY2, and MY3 of the mode dial.

#### Registering Shooting Settings (My Settings)

You can register the current camera settings as “My Settings” so that you can easily recall the desired settings for shooting.

Settings can be registered to the following.

MY 1, MY 2, MY 3	Settings can be registered to MY1, MY2, and MY3 of the mode dial.
My Settings Box	Six items of settings can be registered to the camera. Assign the items to [MY 1], [MY 2], and [MY 3] in [Recall My Settings] (p.116). A name can be assigned to registered settings (p.119).

The following items can be registered.

#### Camera settings

- Shooting mode
- Aperture value and shutter speed in Av, Tv, TAv, and M modes
- Self-timer
- Focus position for manual focus
- Macro
- Flash mode

#### [Shooting] menu

Other than [Multiple Exposure Shooting], [Interval Shooting], [Interval Composite], [Auto Aperture Shift], [Shutter Speed Auto Shift], [Shutter/Aperture Auto Shift], [Switch Shooting Mode], and [Restore Defaults]

#### [Key Custom Options] menu

- Set Fn1 Button
- Effect Button Setting
- Set Fn2 Button
- AFL Focus Settings

#### [Setup] menu

- ISO Step Setting
- ISO Auto-High Settings
- AF Mode
- Level Setting
- Grid Guide Display Options

- 1 Set the functions to register.
- 2 Select [Reg. My Settings] in the [Key Custom Options] menu, and then press the ► button.

The [Reg. My Settings] screen appears.

- 3 Select the location to register the settings, and then press the MENU/OK button.

If you select [MY 1], [MY 2], or [MY 3], the settings are registered to the mode dial.



To save the settings to My Settings Box, select [My Settings Box] and press the ► button to select the number to which to register the settings.

If you select an unregistered location, the settings are registered with the current date and time as the name.



If you select a location that already has a name, the name setting screen appears. If you select [Yes], the settings are registered under the current name. If you select [No], the settings are registered with the current date and time as the name.

The settings are registered, and then the [Key Custom Options] menu reappears.

## Recalling Settings Registered as My Settings

You can assign the settings registered to [My Settings Box] to MY1, MY2, and MY3 of the mode dial.

- 1** Select [Recall My Settings] in the [Key Custom Options] menu, and then press the ► button.

The [Recall My Settings] screen appears.

- 2** Press the ▲▼ buttons to select the location on the dial to assign the settings, and then press the ► button.



- 3** Select the My Settings Box number with the “My Settings” registered, and then press the MENU/OK button.

The selected “My Settings” item is registered to the mode dial, and then the [Key Custom Options] menu reappears.



### Note

- The settings registered to [My Settings Box] are not cleared even when the internal memory is formatted.

## Shooting Images in My Settings Mode

- 1 Turn the mode dial to MY1, MY2, or MY3.

Shooting becomes possible with the settings of "My Settings".

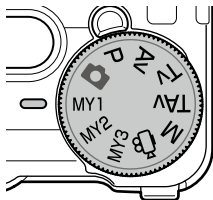

Symbol for registered shooting mode

- 2 To temporarily change the shooting mode, select [Switch Shooting Mode] in the [Shooting] menu.



### Note

- The settings changed in My Settings mode are restored to the settings registered originally for the MY1, MY2, and MY3 of the mode dial if the shooting mode is changed or the power is turned off.
- When the shooting mode registered to "My Settings" is  mode, Step 2 cannot be performed.

## Editing “My Settings”

You can edit the settings registered as “My Settings”.

- 1** Select [Edit My Settings] in the [Key Custom Options] menu, and then press the ► button.

The [Edit My Settings] screen appears.

- 2** Select the “My Settings” item you want to edit, and then press the ► button.

To edit a “My Settings” item saved to My Settings Box, select [My Settings Box] and press the ► button to select a number.

A list of settings appears.

- 3** Press the ▲▼ buttons to select a setting to edit, and then press the ► button.

Use the ▲▼ buttons to change the setting.

- 4** Press the ◀ button to confirm the setting.

Repeat Steps 3 and 4.

- 5** Press the MENU/OK button.

The changes are saved, and then the [Key Custom Options] menu reappears.





## Changing the Name of a “My Settings” Item

- 1** Select [Name] on the screen of Step 3 on p.118, and then press the **▶** button.

The [Name] screen appears and the current name is displayed in the text input area.

If you want to specify a new name, proceed to Step 3.

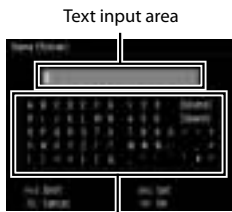

Character selection area

- 2** Press the **◀▶** buttons to move the cursor to the position you want to edit.
- 3** Press the **▼** button.
- 4** Press the **▲▼◀▶** buttons to select a character, and then press the **MENU/OK** button.

The character is inserted at the position of the cursor in the text input area. Select [Delete] to delete a character, and [Space] to insert a space.

You can enter up to 32 alphanumeric characters. The character type can be changed with the Fn2 button.

- 5** Press the **ADJ.** lever.

The name is registered.

**Note**

- If the settings of [MY 1], [MY 2], and [MY 3] are assigned in [Recall My Settings] and the settings of My Settings Box are edited, the changes are also applied to the settings of [MY 1], [MY 2], and [MY 3]. If the settings of [MY 1], [MY 2], and [MY 3] are directly edited, the changes are not applied to the settings of My Settings Box. Furthermore, if the settings of My Settings Box are subsequently edited, the changes are not applied to the settings of [MY 1], [MY 2], and [MY 3].
- The name of the “My Settings” item is displayed when the mode dial is turned to MY1, MY2, or MY3.
- You can delete “My Settings” registrations with [Delete My Settings] of the [Key Custom Options] menu.

**Registering Functions to the ADJ. Lever**

You can register shooting functions to the ADJ. lever so that you can easily recall them by ADJ. lever operation (ADJ. mode).

The following functions can be registered.

Function	Page
Off	—
ISO	* Default setting for [ADJ. Lever Setting 1] p.49
Picture Size	* Default setting for [ADJ. Lever Setting 2] p.54
Aspect Ratio	* Default setting for [ADJ. Lever Setting 3] p.54
Focus	* Default setting for [ADJ. Lever Setting 4] p.56
Image	p.88
Expo. Metering	* Default setting for [ADJ. Lever Setting 5] p.52
Cont. Mode	p.72
Auto Bracket	p.73
Flash Comp.	p.81
Flash Amount	p.82
Dyn Range Comp	p.51
SnapFocusDist.	p.58
Effect	p.83

- 1 Select [ADJ. Lever Setting] in the [Key Custom Options] menu, and then press the ► button.  
The [ADJ. Lever Setting] screen appears.

- 2 Press the ▲▼ buttons to select any of [ADJ. Lever Setting 1] to [ADJ. Lever Setting 5], and then press the ► button.

- 3 Press the ▲▼ buttons to select the function to register, and then press the ◀ button.

Repeat Steps 2 and 3.



- 4 Press the MENU/OK button.  
The [Key Custom Options] menu reappears.

### Using ADJ. Mode

- 1 Press the ADJ. lever in shooting mode.  
The mode switches to ADJ. mode.

- 2 Press the ◀► buttons to select the function to set.  
The setting switches between ADJ. Lever Setting 1 to ADJ. Lever Setting 5.



- 3 Press the ▲▼ buttons to select a value.
- 4 Press the MENU/OK button.  
The selected function is set.



#### Note

- When [Shutter Button Confirmation] of the [Key Custom Options] menu is set to [On], the ADJ. mode setting can be set by pressing the shutter release button halfway.

## Registering Functions to the Fn1, Fn2, and Effect Buttons

You can register functions to the Fn1, Fn2, and Effect buttons so that you can change settings or display a function setting screen by simply pressing these buttons.

Any of the following functions can be registered to each of the Fn1, Fn2, and Effect buttons.

Function	Page
Off	—
28/35 mm 28/35/47 mm	p.55
MultiAF/SpotAF MultiAF/PinpointAF AF/MF AF/Snap AF/Subj.Trckng	p.56
JPEG>RAW JPEG>RAW+	p.54
ND Filter	p.53
Effect * Default setting for [Effect Button Setting]	p.83
FA/Move Target * Default setting for [Set Fn1 Button]	p.63
ISO	p.49
Picture Size	p.54
Aspect Ratio	p.54
Focus	p.56
SnapFocusDist.	p.58
Image	p.88
Expo. Metering	p.52
Cont. Mode	p.72
Multi Exposure	p.74
Auto Bracket	p.73
Flash Comp.	p.81
Flash Amount	p.82
Dyn Range Comp	p.51
Self-timer * Default setting for [Set Fn2 Button]	p.34
Frame Rate (Movies)	p.91

**1** Select [Set Fn1 Button], [Set Fn2 Button], or [Effect Button Setting] in the [Key Custom Options] menu, and then press the **▶** button.

**2** Press the **▲▼** buttons to select the function to register, and then press the **◀** button.

The function is registered, and then the [Key Custom Options] menu reappears.



**Note** -----

- When the power is turned on or the mode dial is turned, the current functions for the Fn1, Fn2, and Effect buttons are displayed. If [Fn Button Settings] of the [Setup] menu is set to [Off], the functions are not displayed.



## Changing Other Settings

### Adjusting the Brightness of the Picture Display

You can adjust the brightness of the picture display.

The default setting is [Auto]. The brightness of the picture display is automatically adjusted depending on ambient brightness.

**1** Select [LCD Brightness] in the [Setup] menu, and then press the **▶** button.

**2** Select [Auto] or [Manual].

When [Auto] is selected, press the MENU/OK button to return to the shooting screen.

When [Manual] is selected, proceed to Step 3.

**3** Press the **▶** button.

The [LCD Brightness] screen appears.

**4** Press the **▲▼** buttons to adjust the brightness.



**5** Press the MENU/OK button twice.

The shooting screen reappears.

## Setting the Information Displayed in Shooting Mode

You can set the information displayed for each number of presses of the DISP. button in shooting mode.

- 1** Select [DISP. Button Display Setting] in the [Setup] menu, and then press the **▶** button.

The [DISP. Button Display Setting] screen appears.

- 2** Press the **◀▶** buttons to set [Use DISP. Screen].

1 to 3 indicate the number of button presses, and OFF indicates that the picture display is off.



- 3** Press the **ADJ.** lever to enable or disable a setting.

A setting without a check mark is disabled (the information is not displayed). 1 cannot be disabled.

- 4** Press the **▲▼◀▶** buttons to select a display item, and then press the **ADJ.** lever to turn it on/off.

Graphic Display	Displays the values that can be set at the bottom of the screen while the aperture value and shutter speed are being changed.
Information Display	Displays symbols for the shooting mode, settings, etc.
Grid Guide	Displays guidelines for shooting. Select the type of grid in [Grid Guide Display Options] of the [Setup] menu.
Level Indicator	Displays an indicator for confirming camera tilt.
Histogram	Displays a histogram.

- 5** Press the **MENU/OK** button.

The [Setup] menu reappears.

## Setting the Operation Sounds

You can set the camera operation sounds in [Operation Sounds] and [Volume Settings] of the [Setup] menu.

There are the following four camera operation sounds.

Shutter sound	Played when the shutter release button is pressed.
Focus sound	Played when the shutter release button is pressed halfway and the subject is focused.
Wi-Fi function sound	Played when the  button is pressed and held and the Wi-Fi function is turned on or off.
Warning sound	Played when an attempt is made to perform an operation that is not available.

You can select [All] or [Shutter Sounds] in [Operation Sounds]. If [Operation Sounds] is set to [Shutter Sounds], the focus sound is not played.

The camera operation sounds can be set to OFF,  (Low volume),  (Medium volume), or  (High volume) in [Volume Settings].

## Setting the File and Folder Names

The name of images and folders is assigned automatically.

File name	R0000001.JPG to R0999999.JPG
Folder name	100 to 999

When the file number exceeds R0\*\*9999, the next folder is created and the file number becomes R0\*\*0001. If the file number exceeds R0\*\*9999 when the folder number is 999, no more files can be stored on the memory card currently inserted.

The file and folder names can be changed.



## Selecting the Folder Name

You can select the folder name in [Folder Name Setting] of the [Setup] menu.

Serial Number	100 to 999
Shooting Date	***_MMDD (3-digit folder number_Date)

## Changing the File Name

You can change the first two characters of file names from "R0".

- 1** Select [Change File Name] in the [Setup] menu, and then press the **▶** button.

The [Change File Name] screen appears.

- 2** Press the **▲▼** buttons to select a character.

Only uppercase alphanumeric characters can be entered.



- 3** Press the **▶** button, and then select the second character in the same way.

- 4** Press the MENU/OK button.

The file name is registered, and then the [Setup] menu reappears.



### Note

- When [Color Space Setting] of the [Setup] menu is set to [AdobeRGB], "\_" (underscore) is added as the first character of file name and only the one character after "\_" can be changed.

## Setting the Serial Number of Files

For file names, a 6-digit serial number (000001 to 999999) is assigned after "R0". In [Card Sequence No.] of the [Setup] menu, you can set whether to use the serial number continuously from the previous memory card when memory cards are replaced.

On	Uses the serial number continuously from the previous memory card even after memory cards are replaced.
Off	Starts from "R0**0001" after memory cards are replaced.

Turn off and back on the power to reflect the setting.

## Resetting the File Number

You can reset the file number to "000001" in [Reset File Number] of the [Setup] menu.



### Note

- If a memory card is not inserted, the file numbers of the internal memory are reset.



### Caution

- If the memory card or internal memory to be reset contains the images, you cannot reset file numbers. Perform the file number reset after initializing the memory card or internal memory.

## Setting the Copyright Notice

You can set a copyright notice to be written as Exif data when images are taken.

- 1** Select [Copyright Notice] in the [Setup] menu, and then press the **▶** button.

The [Copyright Notice] screen appears.

- 2** Press the **▼** button.

The cursor moves to the character selection area.



- 3** Press the **▲▼◀▶** buttons to select a character, and then press the **MENU/OK** button.

You can enter up to 46 alphanumeric characters.

The character type can be changed with the Fn2 button.

- 4** Press the **ADJ.** lever.

The copyright notice is registered, and then the [Setup] menu reappears.



### Note

- A copyright notice that has been written to an image can be checked in the detailed information displayed on the playback screen.

## Checking the Firmware Version

You can view the camera firmware version in [Confirm Firmware Version] of the [Setup] menu. When there is a firmware file on the memory card, you can update the firmware.

For information on version updates, check the RICOH IMAGING website.

[http://www.ricoh.com/r\\_dc/support/](http://www.ricoh.com/r_dc/support/)

## Using Images on a Computer

You can transfer taken still images and recorded movies to a computer by connecting the camera to a computer with a USB cable. You can also use the “Digital Camera Utility 5” software supplied with the camera to convert RAW images.

The following are the computer system requirements for connecting the camera to a computer and using the supplied software.

### Windows

OS	Windows 8.1 (32- and 64-bit), Windows 8 (32- and 64-bit), Windows 7 (32- and 64-bit), or Windows Vista (32- and 64-bit)
CPU	Intel Core 2 Duo or higher
RAM	2 GB or more
HDD	For installing and starting up the program: 100 MB or more of available space For saving image files: Approx. 7 MB/file (JPEG), Approx. 20 MB/file (RAW)
Monitor	1280 × 1024 dots, 24-bit full color or higher

### Macintosh

OS	OS X 10.10, 10.9, 10.8, or 10.7
CPU	Intel Core 2 Duo or higher
RAM	2 GB or more
HDD	For installing and starting up the program: 100 MB or more of available space For saving image files: Approx. 7 MB/file (JPEG), Approx. 20 MB/file (RAW)
Monitor	1280 × 1024 dots, 24-bit full color or higher



#### Note

- QuickTime is required to play back the recorded movies transferred to a computer with an OS other than Windows 8 and Windows 8.1. (A computer with Windows 8 or Windows 8.1 can play back movies with a pre-installed player software.)

You can download it from the following site:

<http://www.apple.com/quicktime/download/>

## Saving Images to a Computer

Use the supplied USB cable to connect the camera to a computer.

**1** Turn off the power of the camera.

**2** Open the terminal cover, and connect one end of the USB cable to the USB/AV OUT terminal on the camera and the other end to the computer.

The camera turns on and "Connecting to PC..." appears on the picture display.

The camera is recognized by the computer as a removable disk.

The files on the memory card are displayed when a memory card is inserted. When a memory card is not inserted, the files on the internal memory are displayed.

**3** Copy and save images to the computer.

**4** Disconnect the USB cable from the computer when the saving is complete.

**5** Disconnect the USB cable from the camera.

The camera turns off automatically.



**Note** -----

- The battery is charged when the camera is connected to the computer.
- If the battery level is low, it may take some time until the camera is recognized by the computer.



**Caution** -----

- Do not disconnect the USB cable during image transfer.

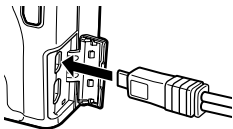



## Operating the Camera with a Communication Device

The images saved in the camera can be displayed on/imported to a communication device by directly connecting both the devices via Wi-Fi and using the dedicated application “Image Sync”.

Image Sync supports iOS and Android. It can be downloaded from the App Store or Google Play Store. For supported OS and other details, refer to the download site.

### Enabling the Wi-Fi Function

The Wi-Fi function is disabled when the camera is turned on. Enable the function using one of the following methods.

- Setting from the menus (p.133)
- Pressing and holding the  button (p.134)
- Touching a communication device (p.134)
- Pressing and holding the  button (p.135)



#### Note

- When the Wi-Fi function is enabled, the symbol indicating the wireless LAN status is displayed on the shooting screen (p.20), and the autofocus/flash lamp blinks.
- Even after the Wi-Fi function is enabled, it is disabled again when the camera is turned off and on again.
- Auto Power Off is not available while a Wi-Fi connection is established or images are being transferred. If Auto Power Off is activated while a connection is not established or during standby, the Wi-Fi function is disabled. The function is enabled when the camera recovers from Auto Power Off.
- If the camera is not operated for 10 seconds or longer when the Wi-Fi function is enabled in playback mode, the camera switches to the sleep mode.
- The Wi-Fi function is disabled during the USB connection.
- The Image Sync screenshots used in this manual are the ones under development and may differ from the actual display. The screen layout and elements may also differ due to causes such as a version upgrade of the application.
- For details on how to operate the communication device, refer to the operating manual of the device.
- You can perform shooting by operating the communication device using the dedicated application “GR Remote”.

For details on how to install and use the “GR Remote”, refer to the following site:

[http://www.ricoh-imaging.co.jp/english/products/gr\\_remote/](http://www.ricoh-imaging.co.jp/english/products/gr_remote/)

**Caution**

- Do not attempt to use the Wi-Fi function in a location where the use of wireless LAN devices is restricted or prohibited, such as on airplanes.
- When using the Wi-Fi function, please observe local laws and regulations governing radio communication.
- If a memory card with a built-in wireless LAN function (such as an Eye-Fi card) is used, radio wave interference may occur. When this occurs, disable the Wi-Fi function of the camera.

**Setting from the Menus**

**1** Select [Wi-Fi] in the [Setup] menu, and then press the ► button.

**2** Press the ▲▼ buttons to select [On].

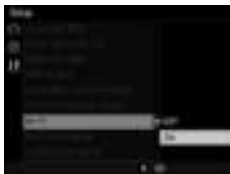

**3** Press the MENU/OK button.

The previous screen reappears.

**Note**

- You can configure the following settings in the [Setup] menu.

Wi-Fi Information	Displays the SSID, password, and MAC address of this camera. To reset the SSID and password to the default settings, press the Fn2 button.
Certification Marks	Displays the certification marks of the wireless LAN.

## Pressing and Holding the Button

- 1** Set [Effect Button Hold Setting] to [Wi-Fi] in the [Key Custom Options] menu.

The default setting is [Wi-Fi].

- 2** Press and hold the  button.

A beep sounds and the Wi-Fi symbol appears on the shooting screen.

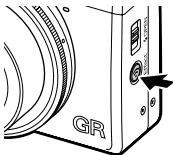

- 3** Release the  button.

To disable the Wi-Fi function, press and hold the  button again.

## 4

### Touching a Communication Device

When this camera comes into contact with a communication device equipped with the NFC function, the camera establishes a Wi-Fi connection.

- 1** Lightly touch the communication device to the NFC mark of the camera.

A beep sounds and the Wi-Fi symbol appears on the shooting screen.

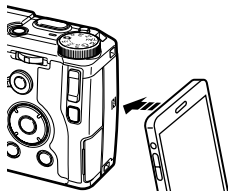

#### Caution

- To establish a Wi-Fi connection by touching a communication device, the Wi-Fi function and the NFC reader/writer function of the device must be enabled in advance. For details on how to operate the communication device, refer to the operating manual of the device.



#### Note

- When the dedicated application “Image Sync” is installed on the communication device, Image Sync is started by touch operation. Touching the communication device again enables the Wi-Fi function of the camera. (p.139) When Image Sync is not installed, the download site for the application is displayed on the communication device.



## Pressing and Holding the Button



The Wi-Fi function can be enabled in playback mode from the power-off state of the camera.

### **1** Press and hold the button until a beep sounds.

The camera is turned on in playback mode and the Wi-Fi function is enabled.



#### **Caution** -----

- When the Wi-Fi function is enabled using the  button, the camera is not switched to shooting mode even if the shutter release button is pressed. When performing shooting or other operations, press the  button to turn the camera off and press the POWER button to turn the camera back on.

## Operating the Camera with a Communication Device

### Connecting the Camera and Communication Device

Connect the camera and communication device via Wi-Fi, and start Image Sync installed on the communication device.

See “Enabling the Wi-Fi Function” (p.132) to enable the Wi-Fi function of the camera.

#### When an NFC-compatible Device is Used

- 1** Set the wireless LAN (Wi-Fi) function and the NFC reader/writer function to ON on the communication device.
- 2** Lightly touch the communication device to the NFC mark of the camera.

A Wi-Fi connection is established between the camera and communication device.

Image Sync is started, and the list of images appears.

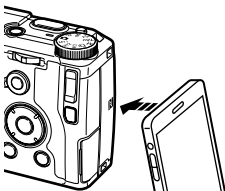

#### When a Non-NFC-compatible Device is Used

- 1** Set the wireless LAN (Wi-Fi) function to ON on the communication device.
- 2** Start Image Sync on the communication device.

The [Choose a Network] screen appears on the communication device.

### 3 Tap [RICOH\_XXXXXX] in the [Network List].

The [Enter Password] screen appears.



### 4 Enter the password, and tap [Connect].

A Wi-Fi connection is established between the camera and communication device.

The list of images appears on the Image Sync screen.

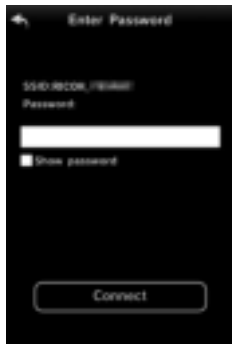

#### Note

- You can check the default password in [Wi-Fi Information] of the [Setup] menu. (p.133)

## When an iOS Device is Used

- 1** Set the wireless LAN (Wi-Fi) function to ON on the communication device.

Tap [RICOH\_xxxxxx] in the list of detected Wi-Fi networks.

- 2** Enter the password, and tap [Join].

A Wi-Fi connection is established between the camera and communication device.



- 3** Start Image Sync on the communication device.

The list of images appears on the Image Sync screen.

## Viewing Images

You can view the images saved either in the camera or in the communication device using Image Sync.

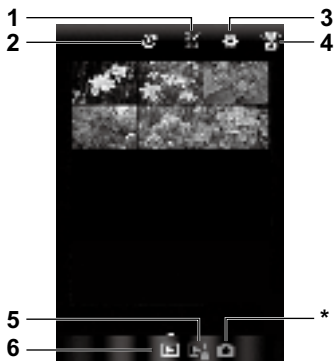

1	Multiple image selection button
2	Album selector button (available for the application image list only)
3	Settings (p.143)
4	NFC connection screen
5	Images in the camera
6	Images in the communication device

\* This icon cannot be selected.

Tap the image to display the full-screen image and shooting information.

Flick left/right to display the previous/next image. Pinch out/in to magnify/reduce the image.



## Selecting the Image Storage Location

When viewing images in application image list display, you can select the image storage location (album) from [Application] or [Gallery] (or [Camera Roll]).

**1** Tap .



**2** Select the album.

The images in the selected album are displayed.

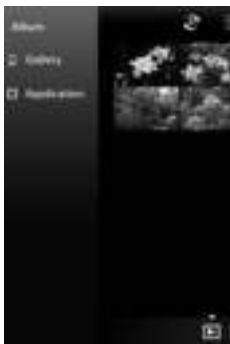

## Selecting Multiple Images

**1** Tap .



**2** Tap the images to select.  
Blue check marks appear.



**3** Touch and hold one of the selected images.

## 4 Select the desired action.



### Note

- When you touch and hold the desired image shown in the list display, the same screen as Step 4 appears and you can select the action to apply.



## Changing the Settings

### 1 Tap .



The [Settings] screen appears.

The following settings are available.

Camera Power Off	Turns off the power of the camera.
General Settings	Changes the communication settings and the display language.

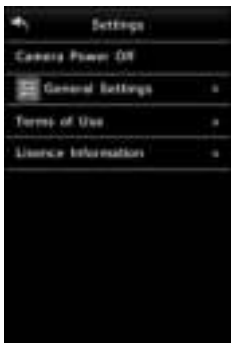

### 2 Tap [General Settings] if you change the communication settings and the display language.

**3** Tap the setting item to be changed.

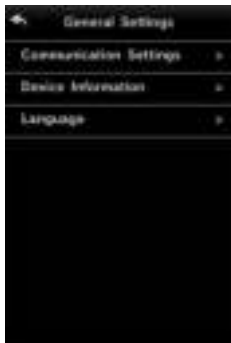

Communication Settings	The password and wireless channel can be changed.
Device Information	The application version, camera model, SSID, MAC address, and wireless channel can be checked.
Language	English or Japanese can be selected.

**4** Change the settings and tap ↶ twice.

The camera functions are mainly set with the menus.

The following menus are available. (The underlined settings are the default settings.)

## [Shooting] Menu



Use this menu to set the shooting settings. This menu is displayed in shooting mode. The options that can be selected vary depending on the position of the mode dial.



Menu option	Settings	Page
Focus	<u>Multi AF</u> , Spot AF, Pinpoint AF, Subj. Tracking, MF, Snap, ∞	p.56
Snap Focus Distance	1m, 1.5m, 2m, <u>2.5m</u> , 5m, ∞	p.58
Full Press Snap	Off, <u>On</u> , Auto-Hi ISO	p.66
FA/Move Target	Move Target Setting: AE-AF, <u>AE</u> , AE Focus Assist Setting: <u>Off</u> , MODE 1, MODE 2, MODE 3, MODE 4 Magnification Setting: <u>Magnify portion</u> , Magnify whole	p.63
Exposure Metering	<u>Multi</u> , Center, Spot	p.52

Menu option	Settings	Page
Picture Format	Format/Size: <b>RAW</b> , <b>RAW+</b> , <b>L</b> , <b>M</b> , <b>S</b> , <b>XS</b> Aspect Ratio: <u>3:2</u> , 4:3, 1:1	p.54
Movie Format*1	Still Image Size: <b>FullHD</b> , <b>HD</b> , <b>VGA</b> Frame Rate: 60 Frames/Sec, 50 Frames/Sec, <u>30 Frames/Sec</u> , 25 Frames/Sec, 24 Frames/Sec	p.91
Effect	<u>Off</u> , Black & White, B&W (TE), Hi-Contrast B&W, Cross Process, Positive Film, Bleach Bypass, Retro, Miniaturize, Shift Crop, High Key, HDR Tone, Clarity, Brilliance, Slight, Vibrant, Bright, Portrait	p.83
Image Settings	Vivid, <u>Standard</u> , Setting1, Setting2	p.88
Crop	<u>Off</u> , 35 mm, 47 mm	p.55
Date Imprint	<u>Off</u> , Date, Date and Time	p.90
Ambient Brightness*2	Original, <u>Normal</u>	p.89
Continuous Mode	<u>Off</u> , Continuous	p.72
Auto Bracket	<u>Off</u> , AE-BKT 1/3EV, AE-BKT 1/2EV, WB-BKT, WB-BKT Preset, Effect-BKT, DR-BKT, CONTRAST-BKT	p.73
Multiple Exposure Shooting	Automatic Exposure: <u>Off</u> , <u>On</u> Save Each Image: <u>Off</u> , <u>On</u> Save in process: <u>Off</u> , <u>On</u>	p.74
Interval Shooting	<u>00 Min. 01 Sec.</u> to 60 Min. 00 Sec. 1 to $\infty$ (Infinity) Pics	p.76
Interval Composite*3	Interval: <u>Min.</u> (Minimum) to 60 Min. Save Interval Composite Img.: <u>Off</u> , Save Each Image, Save in process	p.77
Custom Self-Timer	Pictures: 1 to 10 Pics [ <u>2 Pics</u> ] Interval: 5 to 10 Sec. [ <u>5 Sec.</u> ]	p.35

Menu option	Settings	Page
White Balance	Auto, <u>Multi-P AUTO</u> , Outdoors, Shade, Cloudy, Incandescent 1, Incandescent 2, Daylight FL, Neutral White FL, Cool White FL., Warm White FL, CTE, CT, Manual	p.67
ISO Setting/NR	ISO Setting: <u>Auto</u> , Auto-Hi, ISO 100 to ISO 25600 Noise Reduction: Off, <u>Auto</u> , Manual	p.49
Exposure Compensation	-4.0 to +4.0	p.48
ND Filter	Off, <u>Auto</u> , On	p.53
Dynamic Range Compensation	<u>Off</u> , Auto, Weak, Medium, Strong	p.51
Slow Shutter Speed NR	Off, <u>On</u>	p.47
Auto Aperture Shift <sup>4</sup>	<u>Off</u> , On	p.44
Shutter Speed Auto Shift <sup>5</sup>	<u>Off</u> , On	p.44
Shutter/Aperture Auto Shift <sup>6</sup>	<u>Off</u> , Aprtr Priority, Shttr Priority	p.44
Flash Exposure Compensation	-2.0 to +2.0	p.81
Manual Flash Amount	Full, 1/1.4, <u>1/2</u> , 1/2.8, 1/4, 1/5.6, 1/8, 1/11, 1/16, 1/22, 1/32, 1/64	p.82
Flash Synchro Settings	<u>1st Curtain</u> , 2nd Curtain	p.82
Wireless Flash Channel	<u>CH.1</u> , CH.2, CH.3, CH.4	p.168
P Mode Selection <sup>7</sup>	<u>Normal</u> , Max Aperture Prior.	p.44
Reduce Fluorescent Flicker <sup>1</sup>	<u>Off</u> , 50 Hz, 60 Hz	p.91
Switch Shooting Mode <sup>8</sup>	 P, Av, Tv, TAv, M	p.117
Restore Defaults	—	p.154

- \*1 This setting can be displayed only when the mode dial is set to .
- \*2 This setting can be displayed only when the mode dial is set to P, Av, Tv, TA<sub>v</sub>, M, or .
- \*3 This setting can be displayed only when the mode dial is set to Av, Tv, TA<sub>v</sub>, or M.
- \*4 This setting can be displayed only when the mode dial is set to Av.
- \*5 This setting can be displayed only when the mode dial is set to Tv.
- \*6 This setting can be displayed only when the mode dial is set to TA<sub>v</sub>.
- \*7 This setting can be displayed only when the mode dial is set to P or M.
- \*8 This setting can be displayed only when the mode dial is set to MY1, MY2, or MY3.

## [Playback] Menu

This menu is displayed in playback mode. Use this menu to manage and correct images.

Menu option	Page
RAW Development	p.108
Level Compensation	p.104
White Balance Compensation	p.106
Color Moire Correction	p.107
Trim	p.102
Resize	p.102
Skew Correction	p.103
Clip Movie File	p.94
Slide Show	p.95
Protect	p.99
DPOF	p.112
Copy to Card from Internal Memory	p.101



## [Key Custom Options] Menu

Use this menu to register frequently used shooting settings and change the functions of buttons and lever.



Menu option	Settings	Page
Reg. My Settings	MY 1, MY 2, MY 3, My Settings Box (1 to 6)	p.114
Recall My Settings	—	p.116
Edit My Settings	—	p.118
Delete My Settings	—	p.120
ADJ. Lever Setting	Off, ISO [ADJ. Lever Setting 1], <u>Picture Size</u> [ADJ. Lever Setting 2], <u>Aspect Ratio</u> [ADJ. Lever Setting 3], <u>Focus</u> [ADJ. Lever Setting 4], Image, <u>Expo. Metering</u> [ADJ. Lever Setting 5], Cont. Mode, Auto Bracket, Flash Comp., Flash Amount, Dyn Range Comp, SnapFocusDist., Effect	p.120
ADJ. Direct ISO Control	On, <u>Off</u>	p.49
M/TAv Mode Dial Setting	<u>Setting1</u> , Setting2	p.44
Playback Mode Dial Options	<u>Setting1</u> , Setting2	p.96
Set Fn1 Button Set Fn2 Button Effect Button Setting	Off, 28/35 mm, 28/35/47 mm, MultiAF/SpotAF, MultiAF/PinpointAF, AF/MF, AF/Snap, AF/Subj.Trckng, JPEG>RAW, JPEG>RAW+, ND Filter, <u>Effect</u> [Effect Button Setting], <u>FA/Move Target</u> [Set Fn1 Button], ISO, Picture Size, Aspect Ratio, Focus, SnapFocusDist., Image, Expo. Metering, Cont. Mode, Multi Exposure, Auto Bracket, Flash Comp., Flash Amount, Dyn Range Comp, <u>Self-timer</u> [Set Fn2 Button], Frame Rate	p.122
Effect Button Hold Setting	<u>Wi-Fi</u> , Aperture Preview	p.47 p.134



Menu option	Settings	Page
AEL/AFL Setting	<u>AFL</u> , AEL-AFL, AEL	p.60
C-AF Continuous Setting	<u>Off</u> , AF Priority, Shutter Priority	p.62
AEL/AFL Lock keep Setting	On, <u>Off</u>	p.61
AFL Focus Settings	<u>Off</u> , Multi AF, Spot AF, Pinpoint AF	p.60
One Press M Mode	<u>Aprtr Priority</u> , Shttr Priority, Program	p.48
Shutter Button Confirmation	On, <u>Off</u>	p.48 p.121
Restore Defaults	—	p.154

## [Setup] Menu

Use this menu to set the general operations of the camera.



Menu option	Settings	Page
Format [Card]	—	p.24
Format [Internal Memory]	—	—
Reset File Number	—	p.128
Change File Name	R0	p.127
Folder Name Setting	<u>Serial Number</u> , Shooting Date	p.127
Card Sequence No.	<u>On</u> , Off	p.128
Copyright Notice	—	p.129
LCD Brightness	<u>Auto</u> , Manual	p.124
Operation Sounds	<u>All</u> , Shutter Sounds	p.126
Volume Settings	Off, Low, <u>Medium</u> , High	p.126
Auto Power Off	Off, 1 to 30 Min. ( <u>5 Min.</u> )	p.28
Sleep Mode	<u>Off</u> , 1 to 30 Min.	p.28
LCD Auto Dim	<u>On</u> , Off	p.28
Power Button Lamp	<u>On</u> , Off	p.28
ISO Step Setting	<u>1EV</u> , 1/3EV	p.49
ISO Auto-High Settings	Maximum ISO: ISO 200, ISO 400, ISO 800, ISO 1600, <u>ISO 3200</u> , ISO 6400, ISO 12800, ISO 25600 Minimum ISO: <u>ISO 100</u> , ISO 200, ISO 400, ISO 800, ISO 1600, ISO 3200, ISO 6400, ISO 12800 Change Shutter Speed: <u>Auto</u> , 1/2, 1/4, 1/8, 1/15, 1/30, 1/60, 1/125, 1/250	p.49
AF Auxiliary Light	<u>On</u> , Off	—
AF Mode	<u>Normal</u> , High Speed	p.57

Menu option	Settings	Page
Level Setting	Off, <u>Level + Tilt</u> , Level	p.37
Level (Tilt) Calibration	Restore Default, Calibration	p.37
Conversion Lens	<u>Off</u> , Wide	p.166
Pixel Mapping	—	p.160
LCD Confirmation Time	Off, <u>0.5 seconds</u> , 1 second, 2 seconds, 3 seconds, Hold	p.34
Grid Guide Display Options	<u>Grid 1</u> , Grid 2, Grid 3	p.125
DISP. Button Display Setting	Use DISP. Screen, Graphic Display, Information Display, Grid Guide, Level Indicator, Histogram	p.125
Information Display Mode	On, <u>Off</u>	p.21 p.44
Fn Button Settings	<u>On</u> , Off	p.123
Auto Rotate	<u>On</u> , Off	p.38
Highlight Alert	On, <u>Off</u>	p.22
One Press Zoom Ratio	4 ×, <u>8 ×</u> , 16 ×	p.96
Target Zoom Play	<u>On</u> , Off	p.96
Playback Order Options	File Numbers, <u>Sht. Date/Time</u>	p.38
Playback Animation	<u>On</u> , Off	p.38
Date Settings	—	p.29
Language/言語 <sup>*1</sup>	<u>English</u> , Japanese, French, German, Spanish, Portuguese, Italian, Dutch, Danish, Swedish, Finnish, Czech, Hungarian, Russian, Turkish, Greek, Polish, Thai, Korean, Traditional Chinese, Simplified Chinese	p.29
Color Space Setting	<u>sRGB</u> , AdobeRGB	—
Video Out Mode <sup>*1</sup>	<u>NTSC</u> , PAL	p.111
HDMI Output	<u>AUTO</u> , 1080i, 720P, 480P	p.111
Store Menu Cursor Position	<u>On</u> , Off	p.154
Confirm Firmware Version	—	p.129
Wi-Fi	<u>Off</u> , On	p.133
Wi-Fi Information	—	p.133
Certification Marks	—	p.133

\*1 The default setting varies depending on the country or region.

**Note**

- The [Interval Shooting] and [Custom Self-Timer] settings are reset to their defaults when the camera is turned off. The settings are retained for all other functions.
- The options set in the [Shooting] menu can be restored to the default settings by using [Restore Defaults] of the [Shooting] menu.
- The options set in the [Key Custom Options] menu can be restored to the default settings by using [Restore Defaults] of the [Key Custom Options] menu. The settings registered with [Reg. My Settings] are not restored to the default settings.
- When [Store Menu Cursor Position] of the [Setup] menu is set to [On], the cursor position of the option last selected is stored, and that option is displayed first when the menu is next displayed.

## Trouble Shooting

### Error Messages

If an error message is displayed, take the steps listed below.



Error message	Cause and solution	Page
Insert card.	No memory card inserted. Insert the card.	p.23
Set the date, time and format.	Date is not set. Set the date.	p.29
FILE NUMBER OVER	The file number limit has been exceeded. Reset the file numbers or use another memory card.	p.126
Unmatched File	The camera cannot display this file. Check the file contents on a computer, and then delete the file.	—
Protected	The file selected for deletion is protected.	p.99
Card Is Write-Protected.	The card is locked. Unlock the card.	—
This file (movie or other file) cannot be selected for printing.	Print settings cannot be set for the selected file.	p.112
Insufficient Memory	The file cannot be saved in the memory. Delete existing files or use a new memory card.	p.97
	Maximum number of images are selected for printing.	—
Format internal memory.	You must format the internal memory. Format the internal memory in [Format [Internal Memory]] of the [Setup] menu.	—
Format the card.	The memory card is not formatted. Format the card in this camera.	p.24
Card Error	Format the memory card again. If, after formatting the card, the error message still appears, the card may be faulty. In this case, do not use the card.	p.24
File not found	No files are available for playback.	—
Out of memory. Cannot record.	The memory is full. Use another memory card, or remove the card and use the internal memory.	—
This function cannot be used currently.	The pixel mapping cannot be performed because the camera or battery is hot. Turn off the camera and wait until the temperature of the camera or battery drops to a normal temperature.	—

## Camera Troubleshooting

### Power Supply

Problem	Cause	Solution	Page
The camera does not turn on.	The battery is exhausted or not inserted.	Correctly insert the battery or charge the battery.	p.23 p.25
	The battery is incompatible.	Use a compatible battery.	—
	The battery is not inserted in the correct orientation.	Insert in the correct orientation.	p.23
The camera turns off during use.	The camera has turned off automatically to save power.	Turn the camera back on.	p.27
	The battery is exhausted.	Charge the battery.	p.25
	The battery is incompatible.	Use a compatible battery.	—
The camera does not turn off.	The camera is malfunctioning.	Remove and reinsert the battery.	p.23
The low battery indicator is displayed or the camera turns off even when a fully charged battery is installed.	The battery is incompatible.	Use a compatible battery.	—
The battery cannot be charged.	The battery has reached end of charging life.	Replace with a new battery.	—
The battery is quickly exhausted.	Ambient temperature is very high or very low.	—	—
	Poor lighting requires extensive use of flash.	—	—

## Shooting

Problem	Cause	Solution	Page
No picture is taken when shutter release button is pressed.	The battery is exhausted.	Charge the battery.	p.25
	The camera is turned off or not in shooting mode.	Press the POWER button to turn the camera on, or press the  button to enter shooting mode.	p.27
	The memory card is not formatted.	Format the card.	p.24
	The memory card is full.	Insert a new card, or delete unwanted files.	p.97
	The memory card has reached end of its working life.	Insert a new card.	—
	The flash is charging.	Wait until the autofocus/flash lamp stops blinking.	—
	The memory card is locked.	Unlock the card.	—
	The memory card contacts are dirty.	Clean with soft, dry cloth.	—
Images cannot be checked after shooting.	Confirmation time is too short.	Change the [LCD Confirmation Time] setting of the [Setup] menu.	p.34
The picture display is blank.	The picture display is dark.	Adjust the picture display brightness.	p.124
	The picture display is off.	Press the DISP. button to turn the picture display on.	p.21
	An AV or HDMI cable is connected.	Disconnect the cable.	p.110
The camera is unable to focus in autofocus mode.	The lens is dirty.	Clean with soft, dry cloth.	—
	The subject is not at center of frame.	Use the focus lock.	—
	The subject is not suitable for autofocus.	Use the focus lock or manual focus.	p.58
	The subject is too close.	Use the macro mode or move away from the subject.	p.59
Images are blurred.	The camera was moved during shooting.	Hold the camera with your elbows pressed against your body. Use a tripod.	—
	When shooting in a dark place, the shutter speed slows down and pictures become easily blurred.	Use the flash. Raise the ISO sensitivity.	p.49 p.79
The flash does not fire. The flash is not charged.	The flash is closed.	Slide the  OPEN switch down to open the flash.	p.79
	The flash cover is not fully open.	Do not obstruct the flash cover.	p.79
	A function preventing flash operation is selected.	To shoot with the flash, change the settings or shooting mode.	p.79
	The battery is exhausted.	Charge the battery.	p.25
The flash does not illuminate the subject.	The distance to the subject is more than 3.0 m from the camera.	Move closer to the subject.	—
	The subject is dark.	Increase flash output.	p.81
	Flash output is too low.	Increase flash output.	p.81
	The flash cover is not fully open.	Do not obstruct the flash cover.	p.79
Images are too bright.	Flash output is too high.	Decrease flash output. Move away from the subject. Use a different light source.	p.81
	The picture display is too bright.	Adjust the picture display brightness.	p.124

Problem	Cause	Solution	Page
Images are too dark.	The subject is poorly lit.	Open the flash.	p.79
	The picture display is too dark.	Adjust the picture display brightness.	p.124
The colors of images are unnatural.	The camera is unable to adjust white balance for shooting conditions using auto white balance.	Include a white object with the subject or select other than [Auto] for white balance.	p.67
The picture display brightness changes during focusing.	Ambient lighting is poor or differs from that used for autofocus.	This is normal and does not indicate a malfunction.	—
Level indicators are not displayed.	[Level Setting] is set to [Off].	Change [Level Setting] to enable level indicator display.	p.36
	Level indicators are hidden.	Use [DISP. Button Display Setting] to change the display setting.	p.125
	The camera is upside down.	Hold the camera in the correct orientation.	—
The image is not level although level indicator showed that the camera was level.	The camera was moving when the picture was taken.	Do not take pictures when you are on moving objects.	—
	The subject is not level.	Straighten the subject.	—



## Playback/Deletion

Problem	Cause	Solution	Page
Shooting information is not displayed.	Information is hidden.	Press the DISP. button to display the information.	p.22
The images cannot be played back, or the images are not displayed on the picture display.	AV or HDMI cable is incorrectly connected.	Reconnect the cable.	p.110
	The [Video Out Mode] setting is incorrect.	Select another video mode.	p.111
The images on the memory card cannot be played back, or the images are not displayed on the picture display.	The card was not formatted in this camera.	Insert a card that has been formatted in this camera and contains images saved with this camera.	—
	The memory card contains images that were not saved normally.	Insert a card with images that were saved normally.	—
	Memory card contacts are dirty.	Clean with soft, dry cloth.	—
	The card is malfunctioning.	Insert another card. If there is no problem at this time, the camera is okay. There may be something wrong with the card, so do not use it.	—
The picture display turned off.	The battery is exhausted.	Charge the battery.	p.25
	The camera has turned off automatically to save power.	Turn the camera back on.	p.27
The file cannot be deleted.	The file is protected.	Remove protection.	p.99
	The memory card is locked.	Unlock the card.	—
The memory card cannot be formatted.	The memory card is locked.	Unlock the card.	—

## Miscellaneous

Problem	Cause	Solution	Page
The memory card cannot be inserted.	The card is not in the correct orientation.	Insert in the correct orientation.	p.23
Camera controls have no effect.	The battery is exhausted.	Charge the battery.	p.25
	The camera is malfunctioning.	Press the POWER button to turn the camera off and back on.	p.27
		Remove and reinsert the battery.	p.23
Date is incorrect.	Date and time are not set correctly.	Set the correct date and time.	p.29
Date has been reset.	The battery was removed.	If the battery is removed for more than about five days, the date setting will be lost. Make the settings again.	p.29
Images are not displayed on an AV device.	The [Video Out Mode] setting is incorrect.	Select another video mode.	p.111
	AV or HDMI cable is incorrectly connected.	Reconnect the cable.	p.110
	The input setting of the AV device is incorrect.	Check the input setting of the AV device.	—
Pixel defects such as bright spots and dark spots appear in the image.	There are defective pixels in the sensor.	Activate [Pixel Mapping] of the [Setup] menu. It takes about 30 seconds to correct the defective pixels, so be sure to install a fully charged battery.	—

# Specifications

## Camera

Lens		Lens Construction: 7 elements in 5 groups (2 aspherical lens elements)
	Focal length	18.3 mm
	35 mm equivalent focal length	Approx. 28 mm
	Aperture	F2.8 to F16
Focus		Multi AF, Spot AF, Pinpoint AF, Subject tracking AF, MF, Snap, Infinity, Face recognition priority AF (in Auto shooting mode / when [Portrait] of [Effect] is set), Continuous AF, Full Press Snap
	Modes	Multi AF, Spot AF, Pinpoint AF, Subject tracking AF, MF, Snap, Infinity, Face recognition priority AF (in Auto shooting mode / when [Portrait] of [Effect] is set), Continuous AF, Full Press Snap
	Focus range (From the front edge of the lens)	Approx. 0.3 m (0.98 ft.) to infinity (standard) Approx. 0.1 m (0.33 ft.) to infinity (macro shooting)
Face detection		Up to 10 people's faces
Number of effective pixels		Approx. 16.2 megapixels
Image sensor		23.7 × 15.7 mm size CMOS
Number of recorded pixels	Still image	[3:2] 4928×3264 ( <b>L</b> ), 3936×2608 ( <b>M</b> ), 2912×1936 ( <b>S</b> ), 1280×864 ( <b>XS</b> ) [4:3] 4352×3264 ( <b>L</b> ), 3488×2608 ( <b>M</b> ), 2592×1936 ( <b>S</b> ), 1152×864 ( <b>XS</b> ) [1:1] 3264×3264 ( <b>L</b> ), 2608×2608 ( <b>M</b> ), 1936×1936 ( <b>S</b> ), 864×864 ( <b>XS</b> )
	Movie	<b>Full HD</b> (1920×1080, 30 fps/25 fps/24 fps) <b>HD</b> (1280×720, 60 fps/50 fps/30 fps/25 fps/24 fps) <b>VGA</b> (640×480, 30 fps/25 fps/24 fps)
File formats	Still image	JPEG Baseline compliant (Exif 2.3), RAW (DNG compliant)
	Movie	MPEG-4 AVC/H.264
Sensitivity (Standard Output Sensitivity)		Auto, Auto-Hi (Maximum ISO/Minimum ISO configurable), Manual (ISO 100 to 25600)
White balance		Auto, Multi-P AUTO, Outdoors, Shade, Cloudy, Incandescent 1, Incandescent 2, Daylight Fl., Neutral White Fl., Cool White Fl., Warm White Fl., CTE, CT (Color Temperature), M (Manual)
Display		3.0" transparent LCD, approx. 1,230 K dots, with protective cover, LCD Brightness (Auto, Manual)
Exposure control	Metering	Multi, Center-weighted, Spot
	Modes	Program AE, Aperture priority AE, Shutter priority AE, Shutter/Aperture priority AE, Manual exposure
	Exposure compensation	Still image: ±4 EV in increments of 1/3 EV Movie: ±2 EV in increments of 1/3 EV
Shooting modes		Auto shooting mode, Program shift mode, Aperture priority mode, Shutter priority mode, Shutter/Aperture priority mode, Manual exposure mode, Movie, My Settings mode
Effect		Black & White, B&W (TE), Hi-Contrast B&W, Cross Process, Positive Film, Bleach Bypass, Retro, Miniaturize, Shift Crop, High Key, HDR Tone, Clarity, Brilliance, Slight, Vibrant, Bright, Portrait

Shooting functions		FA/Move target, Crop (35 mm, 47 mm), Continuous shooting, AE bracket (1/2 EV, 1/3 EV), White balance bracket (preset available), Effect bracket, Dynamic range bracket, Contrast bracket, Multiple exposure shooting, Interval shooting <sup>*1</sup> , Self-timer, Noise reduction, ND Filter (On, Off, Auto), Dynamic range compensation (Auto, Weak, Medium, Strong), Slow Shutter Speed NR, Color space setting, Interval composite, Histogram, Grid guide, Depth-of-field indicator, Electronic level indicator
Playback functions		Auto rotate, Highlight alert, Thumbnail view, Enlarged display (up to 16×), Slideshow, Protect, Resize, Skew correction, Level compensation, White balance compensation, Trim, DPOF setting, Color moire correction, RAW development, Clip movie file, Save still image from movie
Shutter speed		1/4000 sec. to 300 sec., Bulb, Time
Flash	Modes	Auto, Flash On, Flash Synchro., Manual Flash, Red-Eye Flash Auto, Red-Eye Flash On, Red-Eye Flash Synchro., Wireless
	Range	Approx. 0.2 m (0.66 ft.) to 3.0 m (9.8 ft.) (ISO AUTO)
	Guide number	5.4 (ISO 100 equivalent)
Storage media		Internal memory (approx. 54 MB), SD memory card, SDHC memory card, SDXC memory card (SDHC memory card and SDXC memory card conform to UHS-I standards)
Power source		Rechargeable battery DB-65
	Battery life (With dedicated rechargeable battery)	Still image shooting: Approx. 290 shots <sup>*2</sup> Playback: Approx. 190 min. <sup>*3</sup> Movie recording time: Approx. 45 min. <sup>*3</sup>
Interfaces		USB/AV OUT terminal (USB 2.0 compliant, video output, audio output (monaural)), HDMI output terminal (Type D)
Video output		NTSC, PAL
Wireless LAN	Standards	IEEE 802.11b/g/n (standard wireless LAN protocol)
	Frequency (Center frequency)	2412 MHz to 2462 MHz (1ch to 11ch)
	Security	Authentication: WPA2, Encryption: AES
NFC	Standards	ISO/IEC 14443 Type A, ISO/IEC 14443 Type B, JIS X 6319-4 (automatically selected)
	Operating frequency (Center frequency)	13.56 MHz
Dimensions		Approx. 117.0 mm (4.6 in.) (W) × 62.8 mm (2.5 in.) (H) × 34.7 mm (1.4 in.) (D) (excluding projecting parts)
Weight	During shooting	Approx. 251 g (8.9 oz.) (with battery and SD memory card)
	Body only	Approx. 221 g (7.8 oz.) (without battery and SD memory card)

\*1 Flash off mode only

\*2 Recording capacity shows approximate number of shots recorded during CIPA-compliant testing. Actual performance may vary depending on operating conditions. (Excerpt from CIPA standards: With picture display ON, with 50% use of flash, at 23°C)

\*3 According to the result of our in-house testing

## AC-U1 USB Power Adapter

Power supply	100 VAC to 240 VAC (50/60 Hz), 0.2 A
Output voltage	5.0 VDC, 1000 mA
Operating temperature	10°C to 40°C (50°F to 104°F)
Dimensions	42.5 mm (W) × 22 mm (H) × 66.5 mm (D) (excluding power plug)
Weight	Approx. 40 g (excluding power plug)

## DB-65 Rechargeable Battery (Lithium-Ion Battery)

Nominal voltage	3.6 V
Rated capacity	1250 mAh (Min.), 1275 mAh, (Typ.)
Operating temperature	0°C to 40°C (32°F to 104°F)
Dimensions	35.3 mm (W) × 40.3 mm (H) × 9.4 mm (D)
Weight	Approx. 27 g

## Storage Capacity

The following table shows the approximate number of images and recording time (in seconds) of movies that can be saved in the internal memory and a memory card in various formats.

	Format/Size	Aspect Ratio	Focal length *1	Number of recorded pixels	Internal memory	4 GB	32 GB
Still image	<b>RAW</b>	3:2	28 mm	4928 × 3264	1	136	1100
			35 mm	3936 × 2608	2	142	1152
			47 mm	2912 × 1936	2	148	1197
		4:3	28 mm	4352 × 3264	1	138	1117
			35 mm	3488 × 2608	2	143	1163
			47 mm	2592 × 1936	2	148	1203
		1:1	28 mm	3264 × 3264	2	141	1148
			35 mm	2608 × 2608	2	146	1186
			47 mm	1936 × 1936	2	150	1217
	<b>RAW+</b>	3:2	28 mm	4928 × 3264	1	106	858
			35 mm	3936 × 2608	1	119	968
			47 mm	2912 × 1936	1	133	1077
		4:3	28 mm	4352 × 3264	1	110	891
			35 mm	3488 × 2608	1	122	993
			47 mm	2592 × 1936	1	135	1093
		1:1	28 mm	3264 × 3264	1	118	959
			35 mm	2608 × 2608	1	129	1047
			47 mm	1936 × 1936	1	139	1128
	<b>L</b>	3:2	—	4928 × 3264 (Equivalent to 16M)	6	481	3899
		4:3	—	4352 × 3264	7	544	4408
		1:1	—	3264 × 3264	10	719	5825
	<b>M</b>	3:2	—	3936 × 2608 (Equivalent to 10M)	10	746	6041
		4:3	—	3488 × 2608	11	839	6796
		1:1	—	2608 × 2608	15	1109	8978
	<b>S</b>	3:2	—	2912 × 1936 (Equivalent to 5M)	18	1329	10754
		4:3	—	2592 × 1936	21	1475	11934
		1:1	—	1936 × 1936	27	1919	15534
<b>XS</b>	3:2	—	1280 × 864 (Equivalent to 1M)	78	5498	44484	
	4:3	—	1152 × 864	85	5759	46602	
	1:1	—	864 × 864	105	7115	57567	

Save still image from movie	1920 × 1080	—	—	1920 × 1080	47	3328	26927
	1280 × 720	—	—	1280 × 720	92	6549	52989
	640 × 480	—	—	640 × 480	256	18087	146340

\*1 35 mm equivalent focal length

	Size	Frame Rate	Number of recorded pixels	Internal memory	4 GB	32 GB
Movie	Full HD	30 fps	1920 × 1080	36	1277	10226
		25 fps	1920 × 1080	43	1542	12349
		24 fps	1920 × 1080	44	1606	12857
	HD	60 fps	1280 × 720	40	1331	10661
		50 fps	1280 × 720	45	1527	12228
		30 fps	1280 × 720	61	2118	16959
		25 fps	1280 × 720	71	2511	20098
		24 fps	1280 × 720	74	2616	20939
	VGA	30 fps	640 × 480	78	3207	25671
		25 fps	640 × 480	95	3793	30353
		24 fps	640 × 480	95	3936	31497



#### Note

- The figures for movies are the total length that can be recorded. The maximum recording time per shooting is 25 minutes or the equivalent of 4 GB.
- The number of pictures that can be taken may differ from the number of storable images displayed on the picture display.
- The storage capacity varies depending on the shooting conditions and the capacity of the memory.
- The image quality of movies recorded to the internal memory is lower than that of movies recorded to a memory card.

## Optional Accessories

### Conversion Lens, Hood, and Adapter

Remove the ring cap before attaching the conversion lens (GW-3) or the lens hood and adapter (GH-3).

#### Removal

Turn the camera off and rotate the cap counterclockwise until it can be removed.

#### Attachment

With the camera turned off, align the marking on the ring cap (②) with the marking on the camera body (①), and turn the ring cap clockwise until it clicks.

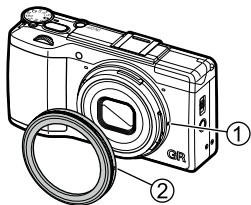

#### Note

- Set [Conversion Lens] of the [Setup] menu to [Wide] when using the conversion lens.



## External Flash

An optional external TTL flash unit (GF-1) can be connected to the camera hot shoe and used as a TTL auto flash.

- 1 Close the flash cover.
- 2 Remove the hot shoe cover from the hot shoe of the camera.
- 3 Turn the camera and the external flash unit off and attach the flash to the camera hot shoe.
- 4 Turn the external flash and camera on.

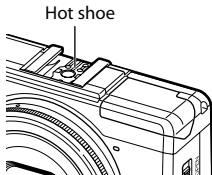

### **Caution** -----

- Do not open the built-in flash when using the external flash as this can result in malfunction or damage to the products.
- Turn the external flash off before removing it from the camera.
- Use the external flash at ranges that exceed the range of the built-in flash. Shooting at a short distance with an external flash may result in over-exposure of the subject.
- When an external flash other than the GF-1 is used, you cannot set the flash mode. The flash always operates with [Flash On].

### **Note** -----

- If the external flash icon is not displayed, turn the GF-1 and camera off and then remove and reattach the flash.
- Press the  button to change the flash mode. (p.79) To fire the flash manually, do so from the GF-1. The output can be set in [Manual Flash Amount] of the [Shooting] menu. (p.82)

## Other Flash Units

- 1** Attach the flash unit to the hot shoe.
- 2** Turn on the camera, turn the mode dial to Av, TAv, or M, and set the aperture.
- 3** Set the ISO sensitivity to a value other than [Auto] or [Auto-Hi].
- 4** Turn on the external flash, set it to Auto, and set the aperture value and ISO sensitivity to the same values on the camera.





### Caution

- Use only flash units with one signal terminal, which must be an X-contact with a positive voltage of no more than 20V.
- A flash signal is output to the X-contact of the hot shoe regardless of the flash setting. Stop operation of the flash unit from the flash unit itself.
- The correct exposure may not be achieved even when the aperture value and ISO sensitivity of the external flash are the same as those of the camera. In this case, change the aperture value and ISO sensitivity of the flash.
- Use an external flash with a lighting angle that covers the angle of view of the shooting lens.

## Shooting with Wireless Flashes

If the camera is combined with the PENTAX auto flash (AF540FGZ II, AF360FGZ II, AF540FGZ, or AF360FGZ), you can use the wireless flash mode to perform P-TTL shooting without connecting the flashes each other.

- 1** Slide the  OPEN switch downward.  
The flash opens.
- 2** Press the  (▶) button.  
The flash mode setting screen appears.
- 3** Press the ◀▶ buttons to select [Wireless].  
The mode of the camera switches to the wireless flash mode.
- 4** Turn on the power of the auto flash, and configure the settings of the auto flash to perform wireless P-TTL shooting with the built-in flash.  
Set the wireless mode of the auto flash to SLAVE.  
For details on how to set the auto flash, refer to the operating manual of the flash.

**5** Select [Wireless Flash Channel] in the [Shooting] menu of the camera, and then press the ► button.

**6** Press the ▲▼ buttons to select a channel.

Select [CH.1], [CH.2], [CH.3], or [CH.4] according to the channel setting of the auto flash used.

**7** Shoot.

The auto flash fires in synchronization with the shutter.



**Note** -----

- If the distance between the auto flash and the camera is too long, the flash may not fire. Keep the distance between the built-in flash of the camera and the auto flash and the distance between the auto flash and the subject within approximately 4 m.
- If the charging of the auto flash is not complete, the flash does not fire.

## Using the Camera Abroad

### Using the AC-U1 USB Power Adapter and BJ-6 Battery Charger

These products are for use with currents of 100 V to 240 V and 50 Hz or 60 Hz.

Before travelling, purchase a travel adapter for connection to the type of outlets used at your destination.

Do not use these products with electrical transformers, as this could damage the camera.

### Television Playback

An AV cable can be used to connect the camera to televisions and monitors equipped with a video input terminal.

The camera supports the NTSC and PAL video formats. Before connecting the camera to an AV device, select the appropriate video output format. (p.111)

When using the camera abroad, check the video output format used at your destination in advance.

# Precautions for Use

## Camera

- This product was manufactured for use in the country of purchase, the warranty is not valid in other countries.
- Should the product fail or malfunction while out of the country, the manufacturer assumes no responsibility for servicing the product locally or bearing any expenditure incurred thereby.
- Do not drop the camera or subject it to physical shocks.
- When carrying the camera, be careful that it does not strike other objects. Particular care is required to protect the lens and picture display.
- The flash may overheat if fired many times in succession. Do not use the flash successively more than necessary.
- Do not use the flash in close contact with your body or other objects. Failure to observe this precaution could result in burns or fire.
- Using the flash unit in close proximity to your subject's eyes could cause temporary visual impairment. Particular care should be observed when photographing infants.
- Do not direct the flash at the operator of a motor vehicle. Failure to observe this precaution could cause accidents.
- Battery may become hot with extended use. Wait for the battery to cool before removing it from the camera.
- The picture display may be difficult to read in direct sunlight.
- You may notice that picture display varies in brightness or contains pixels that do not light or that are always lit. This is common to all LCD monitors and does not indicate a malfunction.
- Do not apply force to the picture display.
- Abrupt changes in temperature may cause condensation, resulting in visible condensation inside the lens or camera malfunction. This can be avoided by placing the camera in a plastic bag to slow the temperature change, and removing it only after the air in the bag has reached the same temperature of its surroundings.
- To prevent damage to the product, do not insert objects into the holes in the microphone and speaker coverings.
- Keep the camera dry and avoid handling it with wet hands. Failure to observe this precaution could result in product malfunction or electric shock.
- Take a test shot to ensure that the camera is functioning properly before using it on important occasions such as travel or weddings. We recommend that you keep this manual and spare batteries at hand.



### **Avoiding Condensation**-----

- Condensation is particularly likely to occur if you move to an area with a sharply different temperature, if humidity is high, in a cold room after the heater has come on, or where the camera is exposed to cold air from an air conditioner or other device.

## AC-U1 USB Power Adapter

- Use the USB cable contained in the package.
- Do not subject the power adapter to severe impact or force.
- Do not use in extreme high or low temperatures or areas subject to vibration.
- Do not use in an area subject to direct sunlight or high temperature.
- Unplug the power plug from the power outlet after charging. Failure to observe this precaution could result in fire.
- Do not allow other metallic objects to come in contact with the connectors or contacts of the rechargeable battery as this can result in a short.
- The operating temperature range is 10°C to 40°C (50°F to 104°F). Charging takes longer at temperatures below 10°C (50°F).



### Caution

- Use of other batteries can cause explosion.
- Recycle used batteries in a recycle box at your local electronics store or supermarket.

## DB-65 Rechargeable Battery

- This is a lithium-ion battery.
- The battery is not fully charged at the time of purchase, so be sure to charge the battery before use.
- Do not open or damage the battery as this can result in fire or injury. In addition, do not heat the battery above 60°C (140°F) or expose the battery to fire.
- Due to the battery characteristics, the battery usage time may be shortened when used in a cold environment, even if the battery is fully charged. Keep the battery warm by placing it in a pocket or have a backup battery ready.
- When not in use, be sure to remove the battery from the camera or the battery charger. A small amount of current can leak from the battery even when the power is off, creating excessive discharge and making the battery unusable. If the battery is removed for more than five days, the date and time settings will be lost. In this case, reset the date and time.
- If the battery is not used for a long time, charge the battery for 15 minutes once a year before storing.
- Store in a dry, cool place with an ambient temperature between 15°C and 25°C (59°F and 77°F). Avoid storing in extreme high or low temperatures.
- After charging the battery, do not immediately charge it again.
- Charge the battery at an ambient temperature between 10°C and 40°C (50°F and 104°F). Charging the battery at a high temperature can deteriorate the battery. Charging at a low temperature may prevent full charging.
- If the battery usage time becomes very short even when fully charged, the battery has reached the end of its useful life. Replace with a new battery. Be sure to use a replacement battery recommended by RICOH IMAGING.
- The recharge time with the AC-U1 is approximately 3 hours (at 25°C (77°F)).

## Camera Care and Storage

### Caring for the Camera

- Image quality can be affected by fingerprints and other foreign matter on the lens. Avoid touching the lens with your fingers.
- Remove dust or lint on the lens with a commercially available blower, or gently clean the lens with a soft, dry cloth.
- Clean the camera thoroughly after using it at the beach or handling chemicals.
- In the unlikely event of malfunction, consult your nearest repair center.
- The camera contains high-voltage circuits. Do not disassemble.
- Do not expose the camera to volatile substances such as thinner, benzine, or pesticides. Failure to observe this precaution could result in damage to the camera or its coatings.
- The picture display is easily scratched, avoid touching it with hard objects.
- Clean the picture display by wiping it with a soft cloth dampened with a small amount of any monitor cleaner that does not contain organic solvents.

### Storage

- Do not store the camera where it will be exposed to:
  - extreme heat or humidity
  - large changes in temperature or humidity
  - dust, dirt, sand, severe vibration
  - prolonged contact with chemicals including mothballs and other insect repellent, or with vinyl or rubber products
  - strong magnetic fields (for example, in the vicinity of a monitor, transformer, or magnet)Otherwise your camera may be damaged.
- Remove the battery if the product is left unused for a long period of time.

### Before Cleaning

- Be sure to turn the camera off.
- Remove the battery.

## Warranty Policy

All our cameras purchased through authorized bona fide photographic distribution channels are guaranteed against defects of material or workmanship for a period of twelve months from the date of your purchase. Service will be rendered, and defective parts will be replaced without cost to you within that period, provided the camera does not show evidence of impact, sand or liquid damage, mishandling, tampering, battery or chemical corrosion, operation contrary to operating instructions, or modification by an unauthorized repair shop. The manufacturer or its authorized representatives shall not be liable for any repair or alterations except those made with its written consent and shall not be liable for damages from delay or loss of use or from other indirect or consequential damages of any kind, whether caused by defective material or workmanship or otherwise; and it is expressly agreed that the liability of the manufacturer or its representatives under all guarantees or warranties, whether expressed or implied, is strictly limited to the replacement of parts as hereinbefore provided. No refunds will be made on repairs by non-authorized service facilities.

### Procedure During 12-month Warranty Period

Any camera which proves defective during the 12-month warranty period should be returned to the dealer from whom you purchased the camera or to the manufacturer. If there are no representatives of the manufacturer in your country, send the camera to the manufacturer, with postage prepaid. In this case, it will take a considerable length of time before the camera can be returned to you owing to the complicated customs procedures required. If the camera is covered by warranty, repairs will be made and parts replaced free of charge, and the camera will be returned to you upon completion of servicing. If the camera is not covered by warranty, regular charges of the manufacturer or of its representatives will apply. Shipping charges are to be borne by the owner. If your camera was purchased outside of the country where you wish to have it serviced during the warranty period, regular handling and servicing fees may be charged by the manufacturer's representatives in that country. Notwithstanding this, your camera returned to the manufacturer will be serviced free of charge according to this procedure and warranty policy. In any case, however, shipping charges and customs clearance fees to be borne by the sender. To prove the date of your purchase when required, please keep the receipt or bills covering the purchase of your camera for at least a year. Before sending your camera for servicing, please make sure that you are sending it to the manufacturer's authorized representatives or their approved repair shops, unless you are sending it directly to the manufacturer. Always obtain a quotation for the service charge, and only after you accept the quoted service charge, instruct the service station to proceed with the servicing.

- **This warranty policy does not affect the customer's statutory rights.**
- **The local warranty policies available from our distributors in some countries can supersede this warranty policy. Therefore, we recommend that you review the warranty card supplied with your product at the time of purchase, or contact our distributor in your country for more information and to receive a copy of the warranty policy.**



## For customers in USA

### STATEMENT OF FCC COMPLIANCE

This device complies with Part 15 of the FCC Rules. Operation is subject to the following two conditions: (1) This device may not cause harmful interference, and (2) this device must accept any interference received, including interference that may cause undesired operation.

Changes or modifications not approved by the party responsible for compliance could void the user's authority to operate the equipment.

This equipment has been tested and found to comply with the limits for a Class B digital device, pursuant to part 15 of the FCC Rules.

These limits are designed to provide reasonable protection against harmful interference in a residential installation. This equipment generates, uses and can radiate radio frequency energy and, if not installed and used in accordance with the instructions, may cause harmful interference to radio communications. However, there is no guarantee that interference will not occur in a particular installation.

If this equipment does cause harmful interference to radio or television reception, which can be determined by turning the equipment off and on, the user is encouraged to try to correct the interference by one or more of the following measures:

- Reorient or relocate the receiving antenna.
  - Increase the separation between the equipment and receiver.
  - Connect the equipment into an outlet on a circuit different from that to which the receiver is connected.
- \* Consult the dealer or an experienced radio/TV technician for help.

### FOR CALIFORNIA, U.S.A. ONLY

Perchlorate Material-special handling may apply.

The lithium battery used in this camera contains perchlorate material, which may require special handling.

See [www.dtsc.ca.gov/hazardouswaste/perchlorate](http://www.dtsc.ca.gov/hazardouswaste/perchlorate)

## For customers in Canada

### Industry Canada (IC) Compliance Notice

This Class B digital apparatus complies with Canadian ICES-003.

This device complies with Industry Canada licence-exempt RSS standard(s). Operation is subject to the following two conditions: (1) this device may not cause interference, and (2) this device must accept any interference, including interference that may cause undesired operation of the device.

## **Pour les utilisateurs au Canada** **Industrie Canada (IC) Avis de Conformité**

Cet appareil numérique de la classe B est conforme à la norme NMB-003 du Canada.

Le présent appareil est conforme aux CNR d'Industrie Canada applicables aux appareils radio exempts de licence.

L'exploitation est autorisée aux deux conditions suivantes : (1) l'appareil ne doit pas produire de brouillage, et (2) l'utilisateur de l'appareil doit accepter tout brouillage radioélectrique subi, même si le brouillage est susceptible d'en compromettre le fonctionnement.

### Declaration of Conformity According to 47CFR, Parts 2 and 15 for Class B Personal Computers and Peripherals

We: RICOH IMAGING AMERICAS CORPORATION  
Located at: 633 17<sup>th</sup> Street, Suite 2600  
Denver, Colorado 80202 U.S.A.  
Phone: 800-877-0155  
FAX: 303-790-1131

6

Appendices

Declare under sole responsibility that the product identified herein complies with 47CFR Parts 2 and 15 of the FCC rules as a Class B digital device. Each product marketed is identical to the representative unit tested and found to be compliant with the standards. Records maintained continue to reflect the equipment being produced can be expected to be within the variation accepted, due to quantity production and testing on the statistical basis as required by 47CFR §2.909. Operation is subject to the following two conditions: (1) This device may not cause harmful interference, and (2) This device must accept any interference received, including interference that may cause undesired operation. The above named party is responsible for ensuring that the equipment complies with the standards of 47CFR §15.101 to §15.109.

Product Name: Digital Camera  
Model Number: GR II  
Contact person: Customer Service Manager  
Date and Place: June, 2015, Colorado

## Information for Users on Collection and Disposal of Old Equipment and Used Batteries



### 1. In the European Union

These symbols on the products, packaging and/or accompanying documents mean that used electrical and electronic equipment and batteries should not be mixed with general household waste.



Used electrical/electronic equipment and batteries must be treated separately and in accordance with legislation that requires proper treatment, recovery and recycling of these products.



By disposing of these products correctly you will help ensure that the waste undergoes the necessary treatment, recovery and recycling and thus prevent potential negative effects on the environment and human health which could otherwise arise due to inappropriate waste handling.

If a chemical symbol is added beneath the symbol shown above, in accordance with the Battery Directive, this indicates that a heavy metal (Hg = Mercury, Cd = Cadmium, Pb = Lead) is present in the battery at a concentration above an applicable threshold specified in the Battery Directive.

For more information about collection and recycling of used products, please contact your local authorities, your waste disposal service or the point of sale where you purchased the products.

### 2. In other countries outside the EU

These symbols are only valid in the European Union. If you wish to discard used products, please contact your local authorities or dealer and ask for the correct method of disposal.

For Switzerland: Used electrical/electronic equipment can be returned free of charge to the dealer, even when you don't purchase a new product. Further collection facilities are listed on the home page of [www.swico.ch](http://www.swico.ch) or [www.sens.ch](http://www.sens.ch).



The CE Mark is a Directive conformity mark of the European Union.

# Index

## Numbers

1st Curtain (Flash).....	82
2nd Curtain (Flash).....	82

## A

ADJ. Direct ISO Control.....	49
ADJ. lever.....	17
ADJ. Lever Setting.....	120
ADJ. mode.....	121
AEL/AFL Lock keep Setting.....	61
AEL/AFL Setting.....	60
AE lock.....	60
AF Auxiliary Light.....	15, 152
AF button.....	60
AF function switching lever.....	60
AF Mode.....	57
Ambient Brightness.....	89
Aperture Preview.....	47
Aperture Priority.....	42
Aperture value.....	42
Aspect Ratio.....	54
Auto Aperture Shift.....	44
Auto Bracket.....	73
Auto flash.....	168
Autofocus/flash lamp.....	25, 33
Auto Power Off.....	28
Auto Rotate.....	38
Auto Shooting Mode.....	32
AV device.....	110
Av mode.....	42

## B

Battery.....	23, 25
Battery/card cover.....	23
Battery level.....	20
Black & White (Effect).....	83
Bleach Bypass (Effect).....	83
Bright (Effect).....	84
Brightness.....	104
Brilliance (Effect).....	84
Bulb.....	46

## C

C-AF Continuous Setting.....	62
Card Sequence No.....	128
Care.....	173

Certification Marks.....	133
Change File Name.....	127
Charging.....	25
Clarity (Effect).....	84
Clip Movie File.....	94
Cloudy (White Balance).....	67
Color Moire Correction.....	107
Color Space Setting.....	153
Color temperature.....	70
Confirm Firmware Version.....	129
Connection to a computer.....	131
Continuous AF.....	62
Continuous Mode.....	72
Contrast.....	83, 104
Contrast Bracket.....	73
Conversion lens.....	166
Copyright Notice.....	129
Correction.....	102
Crop.....	55
Cross Process (Effect).....	83
CTE (White Balance).....	68
Customization.....	114
Custom Self-Timer.....	35

## D

Date Imprint.....	90
Date Settings.....	29
DC power cable cover.....	15
Default settings.....	145
Delete.....	97
Delete My Settings.....	120
Depth of field.....	58
Detailed information display.....	22
Digital Camera Utility 5.....	130
DISP. button.....	21
DISP. Button Display Setting.....	125
DNG.....	54
DPOF.....	112
Dynamic Range Bracket.....	73
Dynamic Range Compensation.....	51

## E

Edit My Settings.....	118
Effect.....	83
Effect Bracket.....	73
Effect button.....	122, 123
Effect Button Hold Setting.....	47
Enlarged view.....	96
Error message.....	155

Exif data .....	129	Information Display Mode .....	21
Exposure .....	42	Internal memory .....	24, 101
Exposure Bracket .....	74	Interval Composite .....	77
Exposure Compensation .....	48	Interval Shooting .....	76
Exposure Metering .....	52	ISO Auto-High Settings .....	49
External flash .....	167	ISO Setting .....	49
		ISO Step Setting .....	49
<b>F</b>		<b>K</b>	
FA/Move Target .....	63	Key Custom Options menu .....	150
File name .....	126	<b>L</b>	
Flash .....	32, 79	Language .....	29
Flash Exposure Compensation .....	81	Language/言語 .....	29
Flash On (Flash) .....	79	LCD Auto Dim .....	28
Flash Synchro. (Flash) .....	79	LCD Brightness .....	124
Flash Synchro Settings .....	82	LCD Confirmation Time .....	34
Fluorescent (White Balance) .....	67	Level Compensation .....	104
Fn1/Fn2 button .....	122	Level Indicator .....	21, 36, 125
Fn Button Settings .....	123	Level Setting .....	37
Focus .....	33, 56	Level (Tilt) Calibration .....	37
Focus assist .....	63	<b>M</b>	
Focus bar .....	58	Macintosh .....	130
Folder name .....	126	Macro mode .....	59
Folder Name Setting .....	127	Manual Exposure .....	42
Format .....	24	Manual Flash Amount .....	82
Format/Size .....	54	Manual Flash (Flash) .....	79, 82
Frame Rate .....	91	Manual focus .....	58
Full Press Snap .....	66	Manual White Balance .....	70
<b>G</b>		Memory card .....	23
Graphic Display .....	21, 125	Menu .....	39, 145
Grid Guide .....	21, 125	MENU/OK button .....	39
Grid Guide Display Options .....	125	MF .....	58
<b>H</b>		Microphone .....	15
HDMI micro output terminal .....	110	Miniaturize (Effect) .....	87
HDMI Output .....	111	M mode .....	42
HDR Tone (Effect) .....	84	Mode dial .....	16
Hi-Contrast B&W (Effect) .....	83	Mode dial lock release button .....	16
High Key (Effect) .....	83	Move Target .....	63
Highlight Alert .....	22	Movie .....	91
Histogram .....	21, 104, 125	M/TAv Mode Dial Setting .....	44
Hot shoe .....	15, 167	Multi AF (Focus) .....	56
<b>I</b>		Multi-P AUTO (White Balance) .....	67
Image Settings .....	88	Multiple Exposure Shooting .....	74
Image Sync .....	132	MY1/MY2/MY3 .....	114
Incandescent (White Balance) .....	67	My Settings .....	114
Infinity (Focus) .....	56	My Settings mode (MY1/MY2/MY3)	
Information Display .....	21, 125		117

## N

Name (My Settings) .....	119
ND Filter .....	53
NFC mark .....	15, 134
Noise Reduction .....	50
Normal indicator display .....	22
NR .....	50

## O

One Press M Mode .....	48
Operation Sounds .....	126
Optional accessories .....	166
Outdoors (White Balance) .....	67

## P

Parts of the camera .....	14
Picture display .....	18
Picture Format .....	54
Pinpoint AF (Focus) .....	56
Pixel Mapping .....	160
Playback .....	38, 95
Playback Animation .....	38
Playback menu .....	149
Playback mode .....	38
Playback Mode Dial Options .....	96
Playback Order Options .....	38
P mode .....	42
P Mode Selection .....	44
Portrait (Effect) .....	84
Positive Film (Effect) .....	83
Power .....	27
POWER button .....	27
POWER button lamp .....	28
Power plug .....	25
Preview .....	47
Processing .....	102
Program diagram .....	44
Program Shift .....	42
Protect .....	99
P-TTL shooting .....	168

## R

RAW .....	54
RAW Development .....	108
Recall My Settings .....	116
Rechargeable battery .....	23, 25
Red-Eye Reduction (Flash) .....	79
Reduce Fluorescent Flicker .....	91
Reg. My Settings .....	115

Release lever .....	23
Reset File Number .....	128
Resize .....	102
Restore Defaults (Key Custom Options) .....	154
Restore Defaults (Shooting) .....	154
Retro (Effect) .....	83
Ring cap .....	166

## S

Saturation .....	83
Self-timer .....	34
Sensitivity .....	49
Setup menu .....	152
Shade (White Balance) .....	67
Sharpness .....	83
Shift Crop (Effect) .....	83
Shooting close-ups .....	59
Shooting menu .....	145
Shooting mode .....	16, 42
Shutter/Aperture Auto Shift .....	44
Shutter/Aperture Priority .....	42
Shutter Button Confirmation .....	48, 121
Shutter Priority .....	42
Shutter speed .....	42
Shutter Speed Auto Shift .....	44
Skew Correction .....	103
Sleep Mode .....	28
Slide Show .....	95
Slight (Effect) .....	84
Slow Shutter Speed NR .....	47
Snap (Focus) .....	58
Snap Focus Distance .....	58
Software .....	130
Speaker .....	15
Specifications .....	161
Spot AF (Focus) .....	56
Still Image Size .....	91
Storage .....	173
Storage capacity .....	26, 164
Store Menu Cursor Position .....	154
Strap eyelet .....	15
Subj. Tracking (Focus) .....	56
Switch Shooting Mode .....	117

## T

Target Zoom Play .....	96
TAv mode .....	42
Terminal cover .....	25

Thumbnail view .....	95
Tilt .....	36
Time.....	46
Toning Effect .....	83
Trim.....	102
Tripod screw hole .....	15
TV .....	110
Tv mode .....	42

## U

Update.....	129
Up-down dial .....	17
USB/AV OUT terminal.....	25, 110, 131
USB cable.....	25, 131
USB power adapter.....	25

## V

Version update .....	129
Vibrant (Effect).....	84
Video Out Mode.....	111
Vignetting .....	83
Vivid (Image Settings).....	88
Volume Settings.....	126

## W

Warranty Policy .....	174
White Balance .....	67
White Balance Bracket .....	73
White Balance Compensation .....	106
Wi-Fi.....	132
Wi-Fi connection.....	20
Wi-Fi Information.....	133
Windows.....	130
Wireless flash.....	168
Wireless (Flash).....	79
Wireless LAN.....	132







**RICOH IMAGING COMPANY, LTD.**

2-35-7, Maeno-cho, Itabashi-ku, Tokyo 174-8639,  
JAPAN

(<http://www.ricoh-imaging.co.jp>)

**RICOH IMAGING EUROPE  
S.A.S.**

Parc Tertiaire SILIC 7-9, avenue Robert Schuman -  
B.P. 70102, 94513 Rungis Cedex, FRANCE

(<http://www.ricoh-imaging.eu>)

**RICOH IMAGING  
AMERICAS CORPORATION**

633 17th Street, Suite 2600, Denver, Colorado 80202,  
U.S.A.

(<http://www.us.ricoh-imaging.com>)

**RICOH IMAGING CANADA  
INC.**

5520 Explorer Drive Suite 300, Mississauga, Ontario,  
L4W 5L1, CANADA

(<http://www.ricoh-imaging.ca>)

**RICOH IMAGING CHINA  
CO., LTD.**

23D, Jun Yao International Plaza, 789 Zhaojiabang  
Road, Xu Hui District, Shanghai, 200032, CHINA

(<http://www.ricoh-imaging.com.cn>)

This contact information may change without notice.  
Please check the latest information on our websites.

• Specifications and external dimensions are subject to change without notice.