

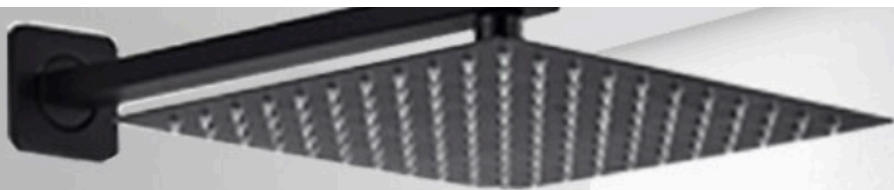

SaniSupreme
Betaalbaar Design



Installatie instructie

SHOWER SYSTEM



Important

Please read the following instructions carefully before installing the shower system.

If you have questions after receiving the goods, please send us an email

To ensure the installation process is safe and fast, it's better if you hire an experienced plumber to complete the installation.

Installation process

1, Before the installation

(1) Check the package

In order to finish the installation smoothly, please check the parts according to the following contents. If there is any transportation damage, missing accessories, or other problems, please contact the seller through Amazon within 15 days, we will solve it in time. After opening the package, please save all the accessories in the package.

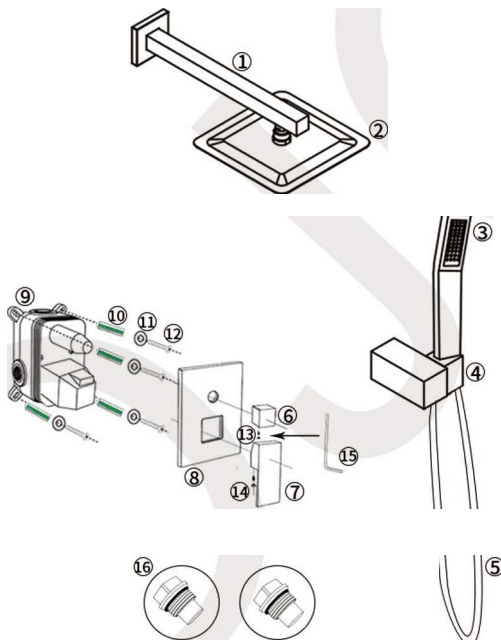

(2)

01	Showerarm	1 DC	11	Metal washer	40cs
02	Shower head	1 DC	11	Screws	40cs
03	Hand shower head	1 DC	1a	Hexaonscrew	20cs
04	Shower helder	1 DC	14	Plastic small cover	20cs
05	Showerhose	1 pc	"	Hexaon screw tool	1 ocs
06	Shower valve knob	1 pc	1 S	elastic sto oer	20cs
07	Shower valve handle	1 pc			
08	Shower valve panel	1 pc			
09	Shower valve bo dy	1 pc			
10	Plast ic screw sleeve	4pcs			

(2) Determine the installation position and height according to the actual situation.

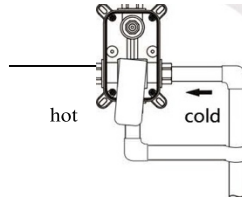

(3) Prepare the tools before the installation

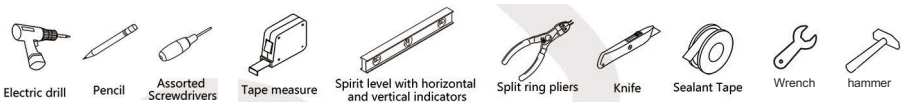

(4) After the installation, you will enjoy the shower set.



2, Installation process

(1) Please turn off the water supply during the installation.

(2) Install the water control valve

1) The installation position and height of water control valve can be determined according to your own actual situation.

2) Please use the level to ensure the valve installation level.

3) Please see the installation steps as follows,

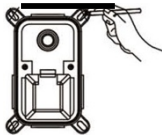

m³/₄

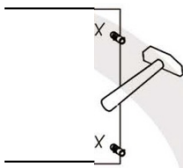
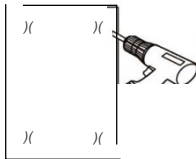

The optimum depth of the water

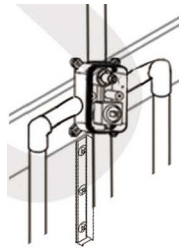

control valve body into the wall is

2.36 inch (60mm) to 3.15 inch

(80mm).

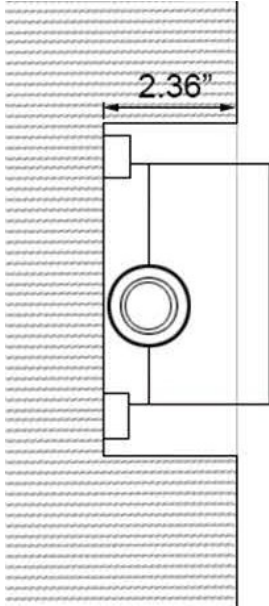

(3) Connecting the inlet and outlet pipe with the valve body; Please notice that before connecting the shower control valve, flush the water inlet pipe to ensure the water in let pipe has no impurities;

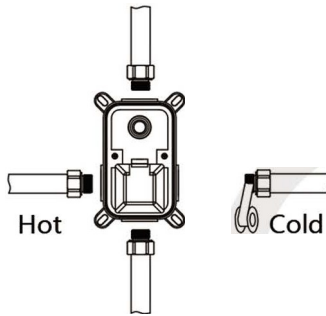

Depth of the outlet pipe: pipe bracket is installed 0.2 inch (5mm) from the front of the finished wall (as picture below)

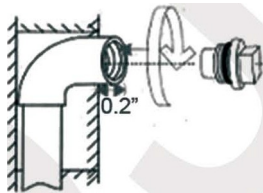

Note:

Install pipes and other components as needed (Note: Please ensure that there are no impurities in the inlet pipe to block the pipe all the time.)

Create enough space for the outlet of the recessed water pipe, the shower wall and the lower nozzle connector.

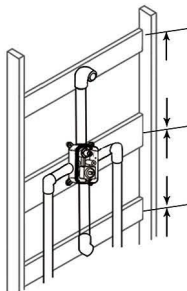

Temporary nipples can be installed on the elbows of the shower tube as needed and fixed with a wrench

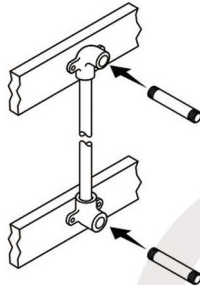

(4) Test work(Very Important)

Check the water pressure and water temperature to prevent blockage and leakage.

1) Before the test work, remove the protective plastic cap and simply install the handle.

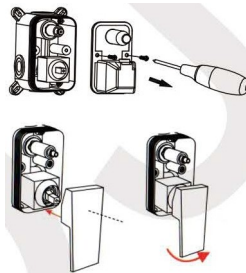

2) During the test, open the water supply system, flush the two outlet pipes by operating the handle, and test whether the water pressure is appropriate.

Operating the handle to close the water and test for pressure resistance and tightness to ensure no leaks.

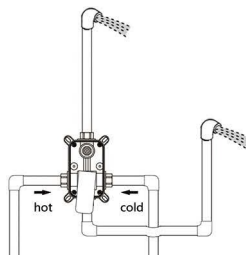

3) After the test is completed, plug all the pipe outlets with a plastic stopper and open the faucet.

Check the connection of the upper and lower outlets of the outlet pipe for tightness and line pressure. Make sure there are no leaks.

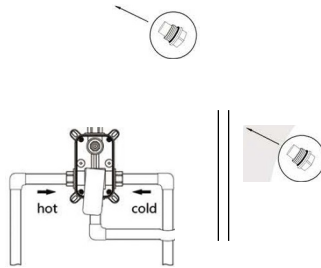

4) After the test, recovery the protective cover.



5) Use a parallel ruler to measure the flatness of the embedded box and the vertical wall.

If the wall is not flat, you can fix it to ensure that the angle between the vertical walls is mostly close to the ideal 90 degree angle to lay the tiles.

After installing the tile, before installing the valve panel, cut the box of the embedded box according to the actual installation depth, so that the panel is well installed.

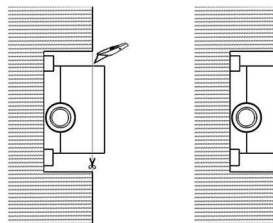

6) Install the valve panel, knob and handle.

7) Install the panel, handle, knob, and shower arm in sequence.

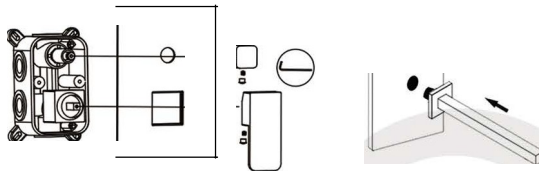

8) Install the handheld shower holder.

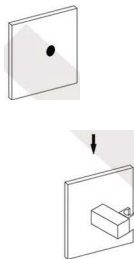

9) Install the shower head and hand shower head.

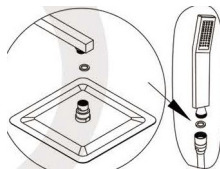

10) Finished.

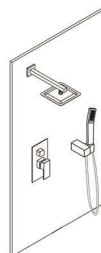

Please note during the installation process:

before filling the wall

- 1) All inlet and outlet pipes must be flushed to prevent obstruction of pipes
- 2) Check the pipe connection to ensure no leakage
- 3) Test the pressure and tightness of the water pipe
- 4) If it is not the bathroom renovation, the shower system is directly installed to the existing pipe, please test whether the fitting length is suitable for your existing pipe. If it does not match, please contact us through Amazon Seller Service, we can re-customize fitting for you..

SYMPTOM

1, No flow or low flow

- (1) **The water pressure in the water supply system is too low**- increase the water supply pressure, or install a booster pump
- (2) **Inlet pipes, outlet pipes, or other pipes are blocked, resulting in low water flow** - please flush the pipes or contact the plumber for disposal (please follow the installation steps above to clean the pipes in advance).
- (3) **Shower head, hose, thermostatic valve inlet/outlet blockage, resulting in low water flow** - regular cleaning to prevent impurities from clogging
- (4) **The filter inlet is partially blocked.** - Clean or repaint and flush the tubing before reinstalling.
- (5) **Correctly use the handle to adjust the water temperature, the water is too cold or too hot** - check the water pressure of the water supply system, increase the water flow or pressure through the booster pump, if the water heater fails, you need to contact the water heater manufacturer to solve.
- (7) **The distance of the water jet is too short** -you need to increase the water pressure (check and adjust the water pressure in the water supply system, or install a booster pump), or pick up the hand shower.

(8) No hot or cold water reaches the shower valve. - Check the cold water and hot water inlet pipes (if the hot or cold supply fails, the valve will close).

(9) **Incorrect installation, resulting in improper inlet pressure** - please refer to the Installation Requirements section (step 5) to ensure that the inlet pressure maintained is normal/balanced and sufficient.

2, Water temperature change

The water temperature suddenly becomes high or low during the shower. - A large amount of cold water or hot water is taken from other places, causing the water pressure to change. Do not use other water outlets during the shower or check if the water heater is working properly;

3, Shower head dripping

(1) **The dripping water is normal if in short time.** - You would try to change the angle of the shower head which may solve this problem.

(2) **If it is a long period of dripping, that may be the shower control valve has not been completely closed.** - Remove the shower control valve assembly and check if the shower valve is blocked.

(3) **The flow control valve seal is damaged.** - Check the status of the flow control valve and replace as needed.

Guarantee

Please remember that: Whether you encounter any problems during use, we can solve them for you, you do not need to dismantle the device. What you need to do is contact us.

Any quality problem occurs, please contact us

Please follow the cleaning material manufacturer' s instructions. In addition, pay attention to the following points:

1. Regular cleaning can prevent mineral build up on shower head and handheld shower.
2. Use a mild detergent such as liquid dishwashing soap and warm water for cleaning.
3. Do not use abrasive / harsh chemical when cleaning the fixture as they will damage and dull the finish.
3. Carefully read the cleaner product label to ensure the cleaner is safe for use on the material.
4. Test the cleaner on a small area before using on the entire surface.
5. Do not leave the cleaner on the fixture longer than necessary.
6. When using spray cleaners, spray first onto a soft cloth or sponge. Never spray directly onto the faucet as droplets can enter openings and gaps and cause damage.
7. After cleaning, rinse thoroughly with clean water to remove any cleaner residue.