

ACHTUNG: Tierspielzeug - nicht unzerstörbar! - Benutzung nur unter unmittelbarer Aufsicht von Erwachsenen! Nicht für Kinder geeignet! Gefahr des Verschluckens von Kleinteilen! Gefahr der Strangulation!

ATTENTION: Animal toy - not indestructible! Usage under direct supervision of adults only! Not suitable for children! Danger of swallowing small pieces! Danger of strangulation!

LET OP: Huisdier Speelgoed- niet onverwoestbaar! Gebruik alléén onder strikt toezicht van een volwassene! - Niet geschikt voor kinderen! - Gevaar voor inslikken van kleine onderdelen! Risico tot wurging!

ATTENTION: Jouet pour animal de compagnie - n'est pas indestructible! A utiliser sous la surveillance d'un adulte! - Ne convient pas aux enfants! Risque d'ingestion de petites pièces! Risque de strangulation!

ATTENZIONE: Giocattolo per animali - non è indistruttibile! Utilizzare sotto la diretta supervisione degli adulti! - Non adatto per bambini! Pericolo di ingestione di piccole parti! Pericolo di soffocamento!

ATENCIÓN: Juguete para animales - no es indestructible! Uso bajo supervisión directa de adultos! No es apto para niños! Peligro de ingestión de piezas pequeñas! - Peligro de asfixia!

PA07-01-078-06

Ref.No.
431-455760



EUROPET BERNINA INTERNATIONAL B.V.
Energieweg 35, 5422 VM Gemert-Bakel
The Netherlands
info@ebi.eu - www.ebi.eu



Akita

Bauanleitung - Assembly instruction - Montage-instructies - Instructions de montage -
istruzioni di montaggio - Instrucción de montaje

1

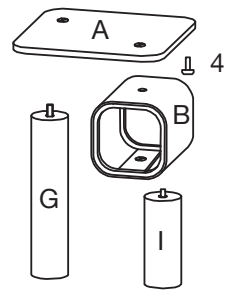

2

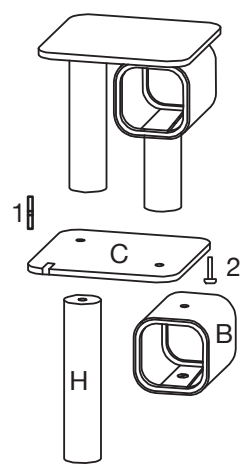

3

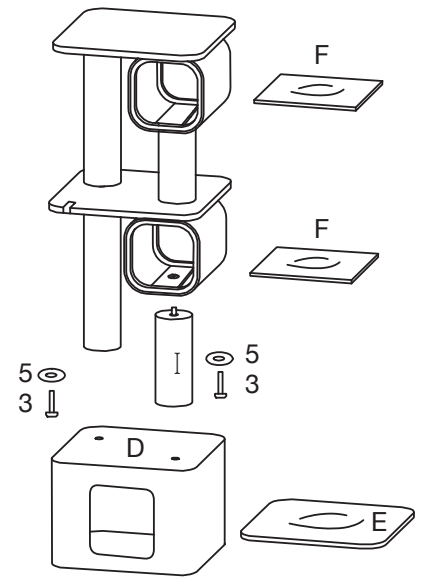

3

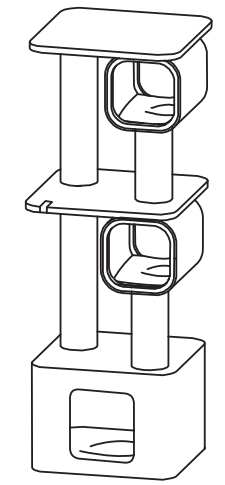

Teile / Delen / Pièces / Parts /
Parti / Piezas

1X  36 x 36 x 2cm (A)

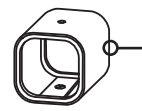
2X  23 x 26 x 23cm (B)

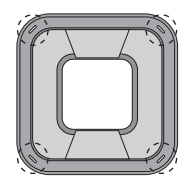
 The backside is with nails
Die Rückseite ist mit Nägeln
De achterkant is voorzien van spijkers
L'arrière est avec des clous
La parte trasera es con uñas.

1X  36 x 36 x 2cm (C)

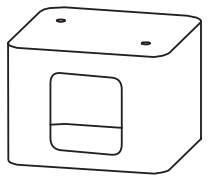
1X  37 x 37 x 27cm (D)

1X  35 x 35cm (E)

2X  22 x 26cm (F)

1X  Ø 9 x 40cm (G)

1X  Ø 9 x 40cm (H)

2X  Ø 9 x 18cm (I)

1X  Ø 8 x 70mm (1)

1X  Ø 8 x 60mm (2)

2X  Ø 8 x 50mm (3)

1X  Ø 8 x 30mm (4)

2X  Ø 30mm (5)

