

IMPORTANT INFORMATION

⚠️ WARNING:

- ADULT SUPERVISION IS REQUIRED when children are playing in or around water.
- Do not sit, stand, or jump on the unit, as doing so may result in injury and/or damage to the unit.
- **Carefully** transform the rear of the car into the pool. Keep fingers clear of moving parts. →
- Always empty the pool of water before storing. Only use clear water in the pool to prevent possible damage.
- Gently wipe down the car with a microfiber towel. Do not use terry cloth towels, paper towels or other abrasive materials as they could damage the finish on the car.
- Immediately wipe up spilled water after playing. To prevent spillage, carefully lift the pool out of the base and empty the water.
- After playing, turn the lights off by pressing the gear shifter to conserve battery power. Headlights will remain on even when closed if the unit is not turned off.
- For best black light surprise results, hold the doll close to the headlights in a dark room.
- Do not look into the headlights for extended periods of time.
- Allow the unit, doll and accessories to air dry by placing on a microfiber towel in a well-ventilated area before storing.
- Keep water away from the battery compartment. If water is present in the battery compartment, dry it thoroughly.
- Do not store the product in direct sunlight for extended periods of time. Discoloration may occur.
- Only one doll is included with this product. O.M.G.™ fashion doll (Outrageous Millennial Girls™) is shown for demonstration purposes only.
- When lifting up the car, please hold the bottom of the car. Do not lift the car by holding the pool.



SAFE BATTERY USAGE

- Use alkaline batteries for best performance and longer life.
- Use only the battery type recommended for the unit.
- Batteries should be replaced only by an adult.
- Insert batteries with the correct polarity (+ and -).
- Do not mix old and new batteries.
- Do not mix alkaline, standard (carbon-zinc), or rechargeable batteries.
- Do not short-circuit batteries.
- When not used for an extended time, remove batteries to prevent possible leakage and damage to the unit.
- Do not mix rechargeable and non-rechargeable batteries.
- Rechargeable batteries are to be removed from the toy before charging.
- Rechargeable batteries are to be recharged only under adult supervision.
- Do not recharge non-rechargeable batteries.
- Exhausted batteries are to be removed from the toy.
- Do not dispose of batteries in fire as they may leak or explode.



'Let's care for the environment!'

The wheelee bin symbol indicates that the product must not be disposed of with other household waste. Please use designated collection points or recycling facilities when disposing of the item. Do not treat old batteries as household waste.

Take them to a designated recycling facility.

Please keep this manual as it contains important information.



1019-0-E

Printed In China

www.LOLsurprise.com

©2019 MGA Entertainment, Inc.

L.O.L. SURPRISE!™ is a trademark of MGA in the U.S. and other countries. All logos, names, characters, likenesses, images, slogans, and packaging appearance are the property of MGA.

MGA Entertainment, Inc.

9220 Winnetka Ave., Chatsworth, CA 91311
U.S.A.
(800) 222-4685

The preferred method of contact for Customer Service is through our e-mail contact form at www.mgae.com

LOL SURPRISE!

CAR-POOL COUPE™

3+

⚠️ **WARNING:**
CHOKING HAZARD—Small parts.
Not for children under 3 years.

SKU: 565222

ADULT SUPERVISION AND BATTERY INSTALLATION REQUIRED

CONTENTS

- A. 1 Car-Pool Coupe™
- B. 1 Exclusive Doll with Outfit, Shoes, Sunglasses, and Bottle
- C. 1 Cup holder

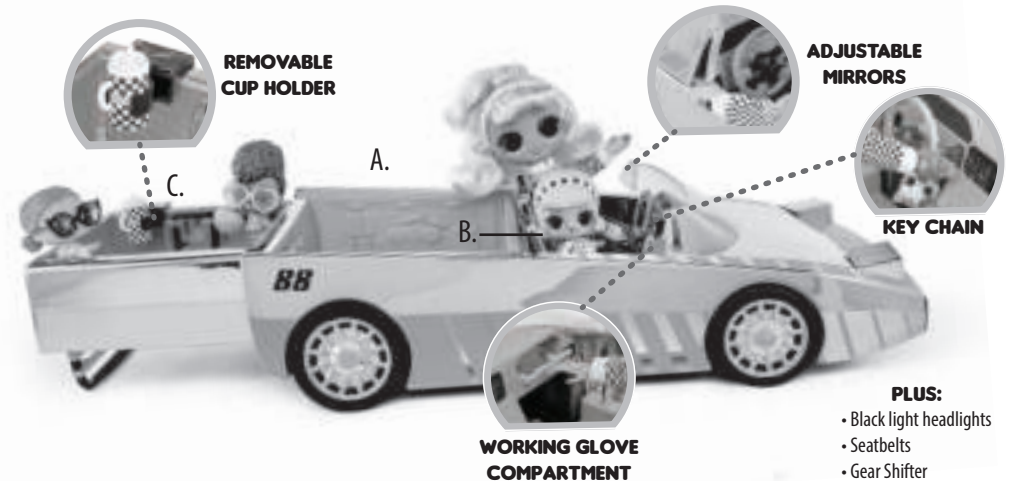

Illustrations are for reference only. Styles may vary from actual contents.

BATTERY INSTALLATION

Before beginning, an adult must install fresh alkaline batteries. Here's how:

1. Using a Phillips screwdriver (not included), remove the screw and battery compartment cover from under the car.
2. Install three (3) fresh 1.5V AAA (LR03) alkaline batteries (not included) making sure the (+) and (-) ends face the proper direction as indicated inside the battery compartment.
3. Replace the compartment cover and securely tighten the screw to ensure the compartment is watertight.

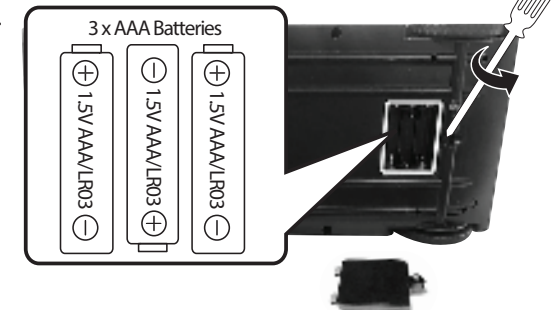

ASSEMBLY

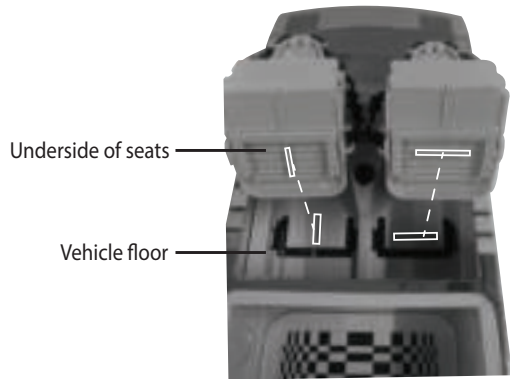

Snap the car seats into place in the vehicle.
 Left seat (driver seat): The vertical lines fit together.
 Right seat (passenger seat): The horizontal lines fit together.

LET'S PLAY!

Before beginning, cover the play area to protect from possible water damage.

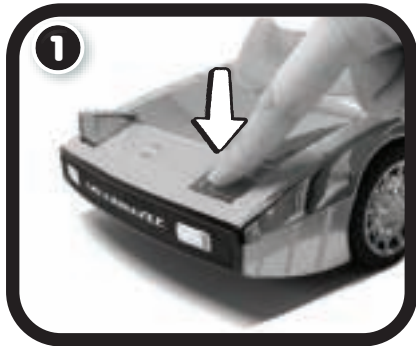

Press down on the headlights to open and close them.



Press the gear shifter to turn the lights on and off.

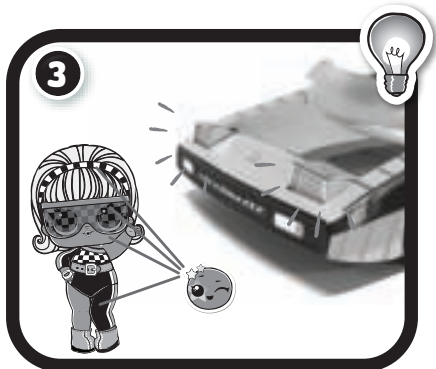

Place your exclusive Tot doll in front of the headlights to see her black light reveals! The closer the doll is to the headlights, the better you can see the reveal! **Pro tip:** darker rooms work best.

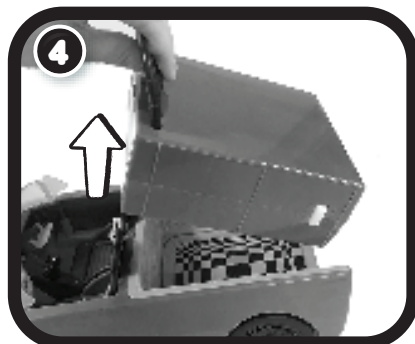

Firmly pull up on the rear of the vehicle to lift it off the car.

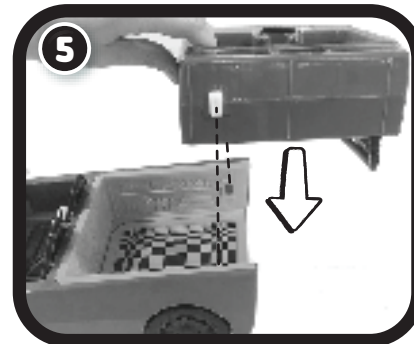

Flip it over, and snap it back into the vehicle by aligning the pegs with the grooves in the car to reveal a pool and dance floor!

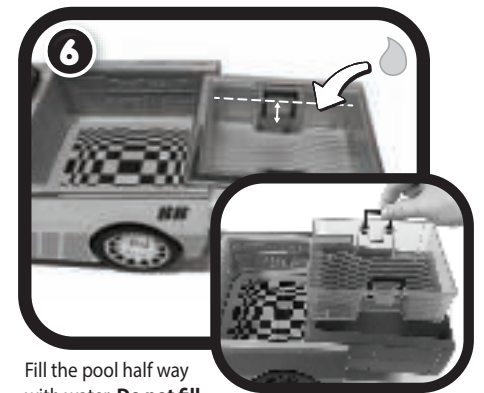

Fill the pool half way with water. **Do not fill water over the handle.** Lift up on the handles to remove the pool and empty the water after playing.



Place L.O.L. Surprise!™ O.M.G.™ fashion dolls (not included) in either seat.

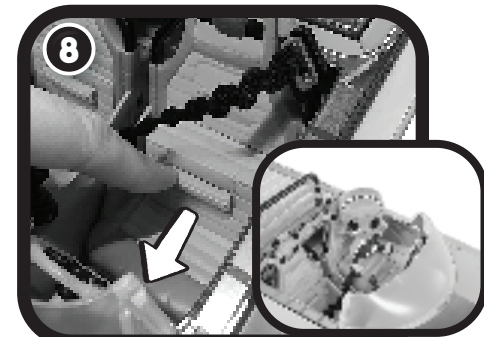

Seats convert so that L.O.L. Surprise!™ dolls can sit and drive.

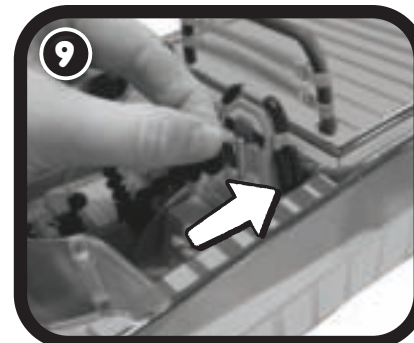

Insert the seatbelt into the shoulder clip to secure it. Gently pull out the seatbelt to release it.

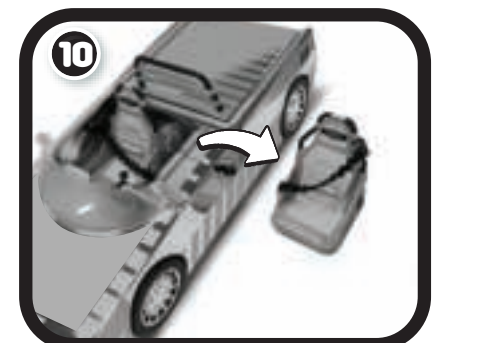

Remove the seats to use them as chairs outside of the car!