

AXA Greenline Front 15 Lux

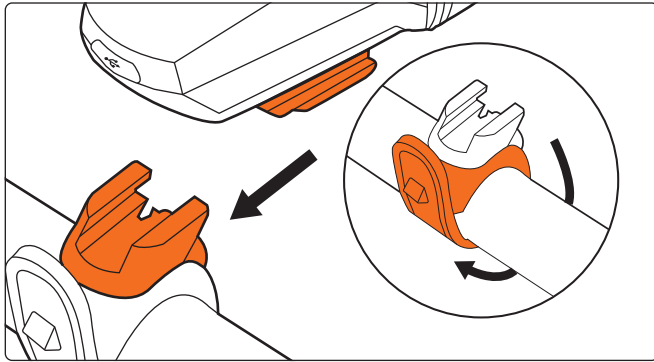

Mounting – Montage – Montage - Montage



Set up – Instellen – Régler - Konfiguration

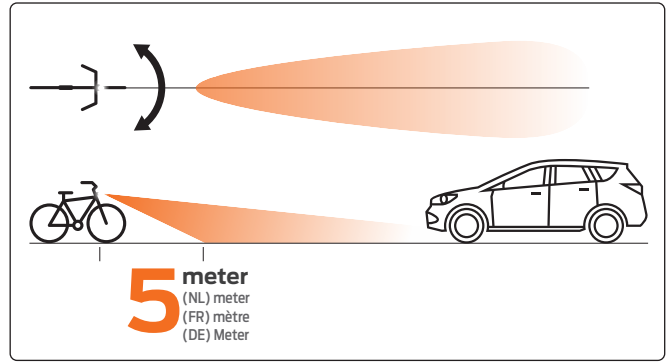

Operation - Bedienung - Utilisation - Bedienung

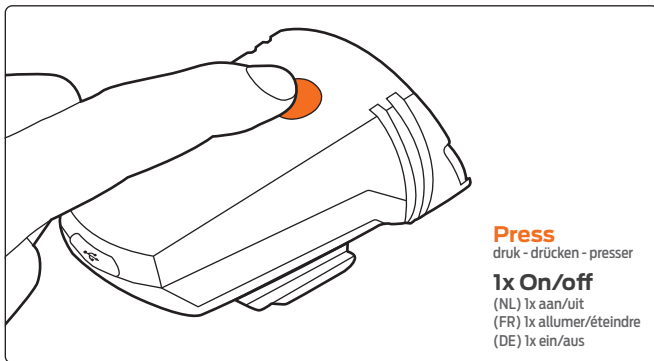

Battery indicator - Accu indicatie - Affichage de l'accumulateur - Akkuanzeige

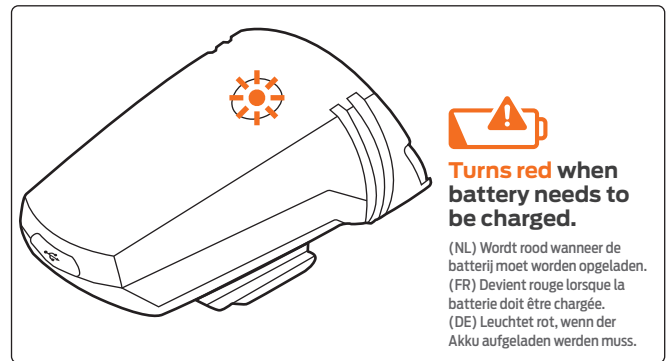

Charging - Laden - Chargement - Laden

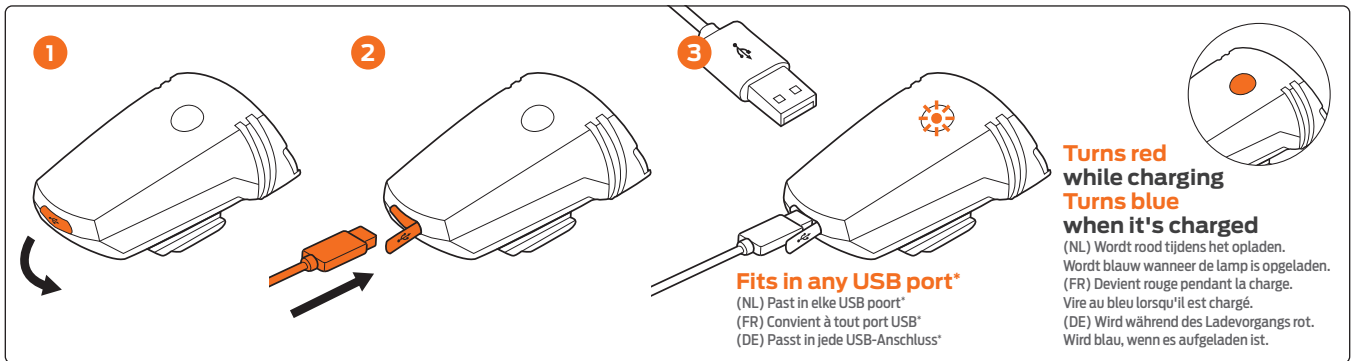

*Max. 5V - Max. 5V - Max. 5V - Max. 5V

Warranty - Garantie - Garantie - Garantie

Damage which is caused by improper use (dropping the light, immersion in water) shall be excluded from the warranty.

The warranty shall expire if the light is opened.

(NL) Schade door oneigenlijk gebruik, (zoals vallen van de lamp, onderdompelen in het water), is van de garantie uit gesloten. De garantie vervalt tevens, wanneer de lamp geopend wordt.

(FR) Les dommages dus à une utilisation impropre (chute de la lampe, immersion dans de l'eau) ne sont pas couverts par la garantie. Le droit à la garantie expire si la lampe est ouverte.

(DE) Schäden, die durch unsachgemäßen Gebrauch (Fallenlassen der Lampe, Eintauchen in Wasser) verursacht werden, sind von der Garantie ausgeschlossen. Der Garantieanspruch verfällt, wenn die Lampe geöffnet wird.

AXA Bike Security

P.O. Box 47, NL-3900 AA Veenendaal

Phone: +31 (0)318 536 220

axabikesecurity.com



AXA is part of the Allegion family of brands.
Product modification reserved.



AXA Greenline

Rear 1 LED



Mounting - Montage - Montage - Montage

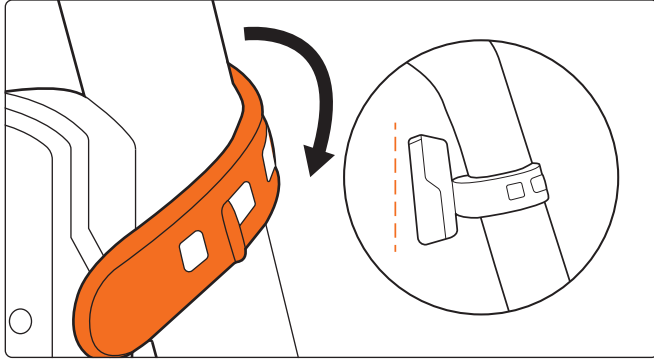

Set up - Instellen - Régler - Konfiguration

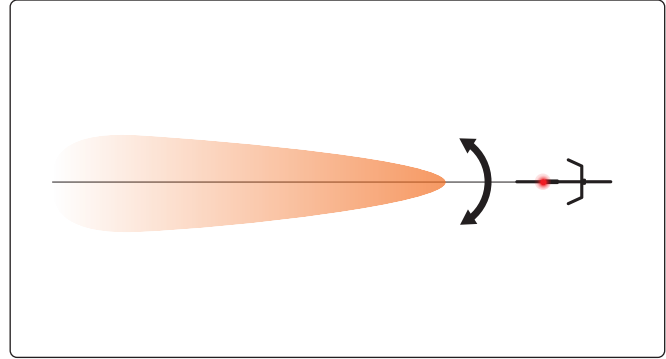

Operation - Bediening - Utilisation - Bedienung

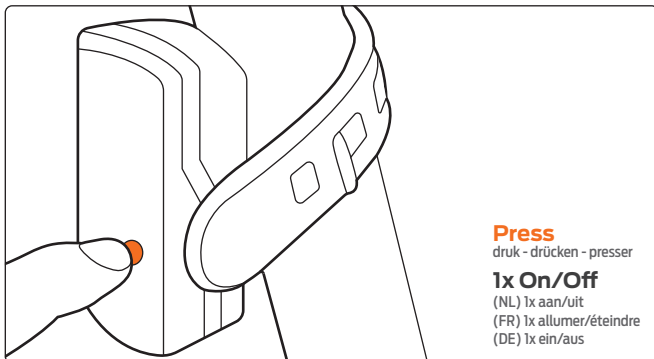

Battery indicator - Accu indicatie - Affichage de l'accumulateur - Akkuanzeige

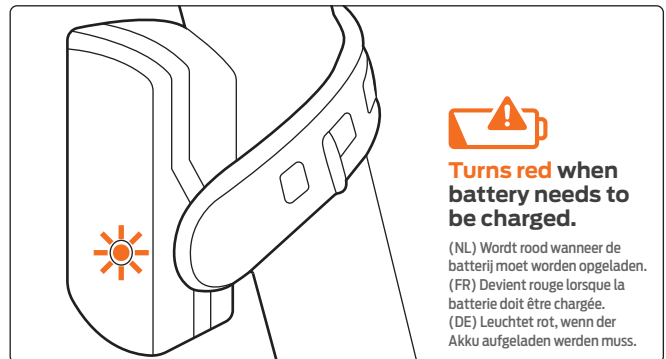

Charging - Laden - Chargement - Laden

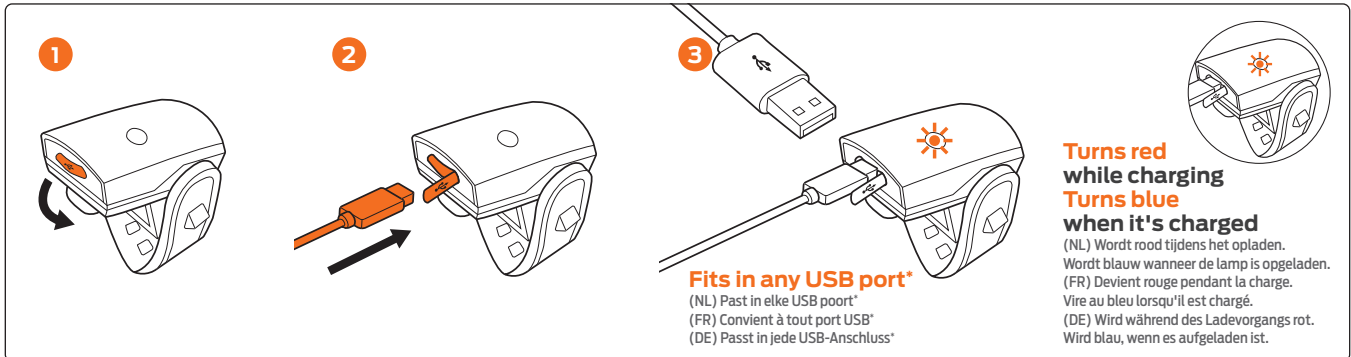

*Max. 5V - Max. 5V - Max. 5V - Max. 5V

Warranty - Garantie - Garantie - Garantie

Damage which is caused by improper use (dropping the light, immersion in water) shall be excluded from the warranty.

The warranty shall expire if the light is opened.

(NL) Schade door oneigenlijk gebruik, (zoals vallen van de lamp, onderdompelen in het water), is van de garantie uit gesloten. De garantie vervalt tevens, wanneer de lamp geopend wordt.

(FR) Les dommages dus à une utilisation impropre (chute de la lampe, immersion dans de l'eau) ne sont pas couverts par la garantie. Le droit à la garantie expire si la lampe est ouverte.

(DE) Schäden, die durch unsachgemäßen Gebrauch (Fallenlassen der Lampe, Eintauchen in Wasser) verursacht werden, sind von der Garantie ausgeschlossen. Der Garantieanspruch verfällt, wenn die Lampe geöffnet wird.

AXA Bike Security

P.O. Box 47, NL-3900 AA Veenendaal

Phone: +31 (0)318 536 220

axabikesecurity.com



AXA is part of the Allegion family of brands.
Product modification reserved.

