

ACCESSOIRES / ACCESSOIRES /
ACCESSORI / ACCESORIOS
Ref. No. 20501

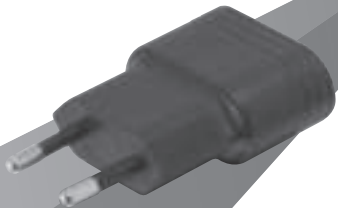

Oplader USB-C
Chargeur USB-C
Caricatore USB-C
Cargador USB-C

ACCESSOIRES / ACCESSOIRES /
ACCESSORI / ACCESORIOS
Ref. No. 18460



USB-C-Kabel
Câble USB-C
Cavo USB-C
Cable USB-C

ACCESSOIRES / ACCESSOIRES /
ACCESSORI / ACCESORIOS
Ref. No. 00152

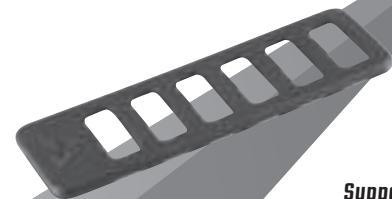

Support en silicone
Supporto in silicone
Soporte de recambio de silicona
Siliconen reservehouder

WAARSCHUWING / AVERTISSEMENT / AVVERTENZA / ADVERTENCIA !

- NL** Mogelijk gevaarlijke optische straling! Kijk bij gebruik nooit direct in de lamp of richt deze nooit op de ogen van andere personen.
- FR** Le rayonnement émis peut être dangereux ! Ne jamais regarder l'éclairage pendant son fonctionnement et ne jamais l'orienter dans les yeux d'autres personnes.
- IT** Radiazioni ottiche potenzialmente pericolose! Non guardare mai direttamente nel fanale quando è in funzione o non puntarlo mai sugli occhi di altre persone.
- ES** ¡Riesgo de radiación nociva! Nunca mires directamente al faro encendido, ni lo orientes hacia los ojos de otras personas.



UKCA STATEMENT

We, SIGMA-ELEKTRO GmbH, declare that the equipment above has been tested in our facility and found compliance with the requirement limits of applicable standards, in accordance with the Radio Equipment Regulations 2017 and the Restriction of the Use of Certain Hazardous Substances in Electrical and Electronic Equipment Regulations 2012. The test record, data evaluation and Equipment Under Test (EUT) configurations represented herein are true and accurate under the standards herein specified.

UK
CA

CE INFORMATION

- EN** SIGMA-ELEKTRO GmbH hereby declares that the BUSTER RL 80 comply with the fundamental requirements and other relevant regulations of Directive 2014/30/EU and RoHS Directive 2011/65/EU. You can find the CE declaration at: ce.sigmaspport.com/busterrl80
- DE** Hiermit erklärt SIGMA-ELEKTRO GmbH, dass sich die BUSTER RL 80 in Übereinstimmung mit den grundlegenden Anforderungen und den anderen relevanten Vorschriften der Richtlinie 2014/30/EU und RoHS Directive 2011/65/EU befinden. Sie finden die Konformitäts-Erklärung unter folgendem Link: ce.sigmaspport.com/busterrl80
- FR** Vous trouverez la déclaration CE à l'adresse : ce.sigmaspport.com/busterrl80
- IT** La dichiarazione CE è disponibile all'indirizzo: ce.sigmaspport.com/busterrl80
- ES** Puede encontrar la declaración de conformidad CE en: ce.sigmaspport.com/busterrl80
- NL** Je kunt de CE-certificering vinden op: ce.sigmaspport.com/busterrl80

FCC DECLARATION OF CONFORMITY

FC

This device complies with Part 15 of the FCC Rules. Operation is subject to the following two conditions:
(1) This device may not cause harmful interference, and (2) This device must accept any interference received, including interference that may cause undesired operation. The grantee is not responsible for any changes or modifications not expressly approved by the party responsible for compliance. Such modifications could void the user's authority to operate the equipment. This equipment should be installed and operated with a minimum distance of 5 millimeters between the radiator and your body.

NOTE:

This equipment has been tested and found to comply with the limits for a Class B digital device, pursuant to part 15 of the FCC Rules. These limits are designed to provide reasonable protection against harmful interference in a residential installation. This equipment generates, uses and can radiate radio frequency energy and, if not installed and used in accordance with the instructions, may cause harmful interference to radio communications. However, there is no guarantee that interference will not occur in a particular installation. If this equipment does cause harmful interference to radio or television reception, which can be determined by turning the equipment off and on, the user is encouraged to try to correct the interference by one or more of the following measures:
- Reorient or relocate the receiving antenna.
- Increase the separation between the equipment and receiver.
- Connect the equipment into an outlet on a circuit different from that to which the receiver is connected.
- Consult the dealer or an experienced radio/TV technician for help.

FCC Caution:

Any changes or modifications not expressly approved by the party responsible for compliance could void the user's authority to operate this equipment.

Radiation Exposure Statement:

The product comply with the FCC portable RF exposure limit set forth for an uncontrolled environment and are safe for intended operation as described in this manual. The further RF exposure reduction can be achieved if the product can be kept as far as possible from the user body or set the device to lower output power if such function is available.

SIGMA



BUSTER RL 80 LUMENS

SP1



≤ 1.5 km



≤ 12h



USB-C



SAFE

SIGMA-ELEKTRO GmbH
Dr. - Julius-Leber-Straße 15
67433 Neustadt / Weinstraße
Germany
Tel. +49 6321-9120-118
kundenservice@sigmasport.com



Designed in Germany
Manufactured in China

185501/2

DO YOU ALSO KNOW
OUR BIKE COMPUTERS?

More SIGMA Bike Computers at sigmasport.com



BC 10.0 WR/WL



ROX 4.0 GPS



ROX 11.1 EVO GPS

TECHNISCHE GEGEVENS / DONNÉES TECHNIQUES / DATI TECNICI / ESPECIFICACIONES TÉCNICAS

NL

Laadtemperatuur:
+10°C tot +45°C

Accutype:
3,7V, 300 mAh

Max. vermogen:
1 W

Beschermingsklasse
water- en stofdichtheid:
IP44

FR

Température de chargement :
+10 °C à +45 °C

Type de batterie :
3,7 V, 300 mAh

Puissance max. :
1 W

Classe de protection contre
l'eau et la poussière :
IP44

IT

Temperatura di carica:
da +10 °C a +45 °C

Tipo di batteria:
3,7 V, 300 mAh

Potenza max.:
1 W

Classe di protezione acqua e polvere:
IP44

ES

Temperatura de carga:
+10°C hasta +45°C

Tipo de batería:
3,7 V, 300 mAh

Potencia máx.:
1 W

Nivel de protección para agua y polvo:
IP44

MONTAGE / MONTAGE / MONTAGGIO / MONTAJE

La diffusion de la lumière ne doit pas être gênée ! / La distribuzione della luce non deve essere coperta! / ¡El haz de luz no se debe tapar con ningún objeto! / De lichtbundel mag niet bedekt zijn!

1

NL Vóór de montage de zadelbuis reinigen en ontvetten, om een goede bevestiging te waarborgen. Let er bij het bevestigen op dat de siliconenbandbevestiging bij de montage zo stevig wordt aangetrokken en aangebracht, dat het achterlicht niet vanzelf kan verschuiven en ook niet en ook niet makkelijk verschoven kan worden. Montagehoogte tussen de 250 en 1200 mm.

FR Avant le montage, nettoyer et dégraisser la tige de selle pour garantir une bonne fixation. Lors de la fixation, veiller à ce que la bande en silicone soit suffisamment serrée pour que le phare arrière ne puisse pas bouger de lui-même ou être déplacé trop facilement. Hauteur de montage entre 250 et 1200 mm.

IT Prima del montaggio pulire e sgrassare il reggisella, per garantire un posizionamento stabile. Per il fissaggio assicurarsi che l'attacco a fascia in silicone durante il montaggio venga fissato saldamente e posizionato in modo tale che il fanale posteriore non possa spostarsi, neanche leggermente. Altezza di

2

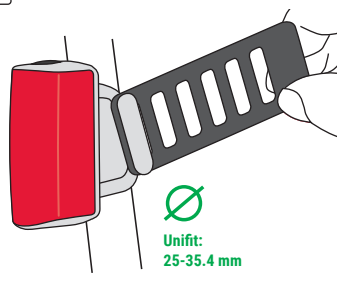

installazione di 250-1200 mm.

ES Antes de montarlo, limpia y desengrasa la tija del sillín para garantizar que se sujete firmemente. Cuando lo fijas, observa que la correa de silicona esté tan apretada que el faro no se pueda mover fácilmente. Altura de montaje entre 250 y 1200 mm.

ALIGNEMENT / ORIENTAMENTO / ALINEAMIENTO / UITLIJNING

NL Afsluitzijde van het achterlicht verticaal met de rijweg en haaks op de hartlijn van de fiets uitlijnen.

FR L'axe longitudinal de l'éclairage arrière doit être perpendiculaire à la route et l'axe transversal doit former un angle droit avec l'axe central du vélo

IT Lato di chiusura del fanalino posteriore perpendicolare alla carreggiata e a 90° rispetto all'asse centrale del veicolo.

ES Sitúa la parte frontal del faro trasero en posición vertical con respecto a la calzada, y en ángulo recto con respecto al eje central de la bicicleta.

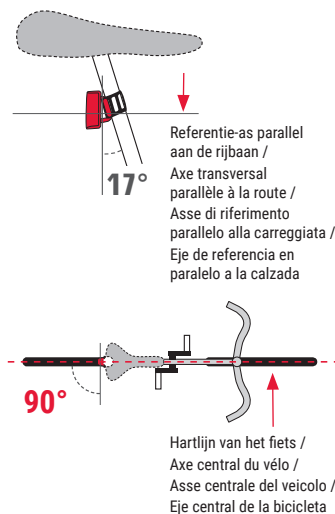

5 MODI / 5 MODES / 5 MODALITÀ / 5 MODOS

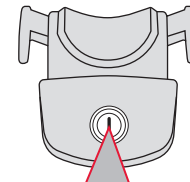

| KNOP BOUTON PULSANTE BOTÓN | MODUS MODE MODALITÀ MODOS | LUMEN LUMEN LÚMENES | BRANDDUUR AUTONOMIE DURATA DURACIÓN |
|-------------------------------------|--|---------------------------|--|
| 2 x short click | AAN / Laatste modus ON / Dernier mode ON / Ultima Modalità ON / Último modo | | |
| + 1 x click | HIGH | ≤ 25 | ≤ 2 h |
| + 1 x click | LOW | ≤ 5 | ≤ 7 h |
| + 1 x click | DAY FLASHING | ≤ 80 | ≤ 4,5 h |
| + 1 x click | NIGHT FLASHING | ≤ 15 | ≤ 6,5 h |
| + 1 x click | ECO FLASHING | ≤ 5 | ≤ 12 h |
| + 1 x click | | | |
| 1 x long click 2 sec. | OFF | | |

LICHT-MODUS GEHEUGENFUNCTIE / FONCTION MÉMOIRE DE MODE / FUNZIONE MODE MEMORY / FUNCIÓN DE MEMORIA DE MODO

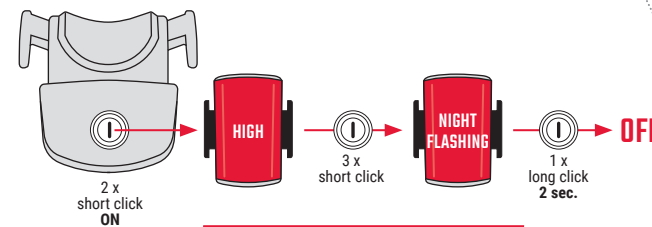

NL Bij het uitschakelen van de BUSTER RL 80 blijft de laatst gebruikte modus behouden.
FR Le dernier mode utilisé est conservé après l'arrêt du BUSTER RL 80.
IT Quando si spegne la BUSTER RL 80 viene memorizzata l'ultima modalità utilizzata.
ES Al apagar el BUSTER RL 80 se mantiene el modo utilizado por última vez.

VOORBEELD / EXEMPLE / ESEMPIO / EJEMPLO

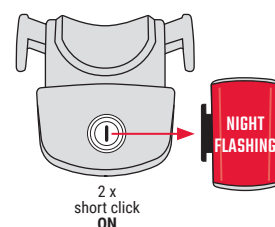

ACCU-INDICATOR / TÉMOIN DE LA BATTERIE / INDICATORE BATTERIA / INDICADOR DE BATERÍA

NL ACCUSTATUS:

Door één keer kort klikken in uitgeschakelde toestand wordt de actuele laadtoestand van de accu weergegeven.

FR ÉTAT DE LA BATTERIE :

L'état actuel de la batterie peut être affiché en faisant un clic court sur le bouton pendant que l'éclairage est éteint.

IT STATO BATTERIA:

A fanale spento 1 breve clic mostra lo stato attuale della batteria.

ES ESTADO DE LA BATERÍA:

Cuando está apagado, 1 breve click muestra el estado actual de la batería.

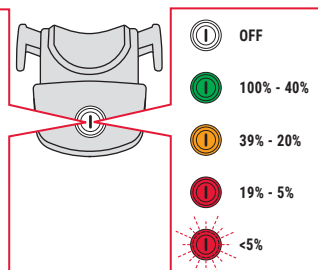

NL **OPMERKING:** Bij minder dan 20% accu capaciteit gaat de rode indicator-LED branden en na circa 45 minuten knippert de rode led. Kort daarna schakelt de BUSTER 150 helemaal uit.

FR **REMARQUE :** Lorsque la capacité de la batterie est inférieure à 20 %, le témoin LED rouge s'allume et, après environ 45 minutes, il commence à clignoter, puis le BUSTER 150 s'éteint complètement peu après.

IT **NOTA:** In caso di capacità della batteria inferiore al 20% l'indicatore a LED rosso si illumina e dopo circa 45 min. il LED rosso lampeggia. In breve tempo la BUSTER 150 si spegnerà completamente.

ES **OBSERVACIÓN:** Si a la batería le queda menos del 20 %, se enciende el indicador LED rojo y, después de aprox. 45 minutos, este LED rojo empieza a parpadear. Poco después, el BUSTER 150 se apaga por completo.

LAADPROCEDURE / PROCESSUS DE CHARGEMENT / PROCESSO DI CARICA / PROCESO DE CARGA

NL Laad de lamp alleen op kamertemperatuur op.

(Laadtemperatuur: +10 °C tot +45 °C)

Let er op dat de rood gemarkeerde afdichting na het laden altijd goed is afgesloten.

Stroomafname via de USB-C aansluiting is niet mogelijk.

FR Chargez la lampe uniquement à température ambiante.

(Température de charge : +10 °C à +45 °C)

Veillez à ce que le cache USB-C étanche indiqué ici en rouge soit correctement refermé après le chargement.

Aucune énergie ne peut être transférée vers l'extérieur par la connexion USB-C.

IT Caricare la lampada solo a temperatura ambiente.

(Temperatura di carica: da +10 °C a +45 °C)

Assicuratevi che la sigillatura contrassegnata in rosso sia sempre chiusa correttamente dopo il processo di ricarica.

Non può essere utilizzata come power bank.

ES Solo cargue la lámpara a temperatura ambiente.

(Temperatura de carga: +10 °C a +45 °C)

Por favor, asegúrate de que el elemento sellante marcado en rojo esté siempre correctamente cerrado después de completar la carga.

No es posible extraer energía del faro usando el puerto USB-C.

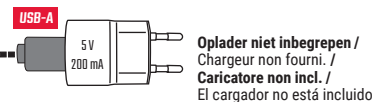
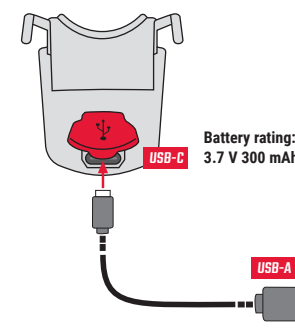

OPLAADINDICATOR / INDICATEUR DU NIVEAU DE CHARGE / INDICATORE DI CARICA / INDICADOR DE CARGA

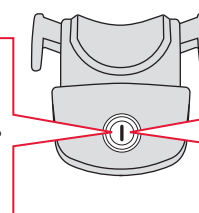
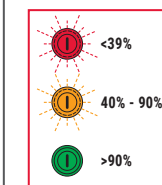

Laadproces ca. 2 h bij 5V / 200 mA /
Chargement : env. 2 h pour 5V 200 mA /
Ricarica in circa 2 ore a 5 V 200 mA /
Proceso de carga de aprox. 2 h a 5V-200 mA

VIDEO TUTORIALS

Gedetailleerde tutorials en gebruikstips kun je vinden onder deze link.

Vous trouverez des tutoriels détaillés et des astuces d'utilisation sous ce lien.

Tutorial dettagliati e consigli per l'uso sono disponibili a questo link.

En este enlace encontrarás tutoriales detallados y consejos de uso.

goto.sigmasport.com/busterrl80/service

