

MEGA **Barbie**  
BUILDING SETS



**WONDER  
BUILDERS™**  
GWR35

**ADVENTURE DREAMCAMPER™**  
**AVENTURE EN CAMPING-CAR DE RÊVE**  
CAMPER DE AVENTURAS • TRAILER DE AVENTURAS  
SUPER ABENTUEVER-CAMPER  
ПРИКЛЮЧЕНИЯ В ДОМЕ НА КОЛЕСАХ

**PLAY AS YOU  
BUILD**  
**JOUEZ EN  
CONSTRUISANT**



**PLAY AS YOU BUILD!**  
**JOUEZ EN CONSTRUISANT!**

JUEGA MIENTRAS CONSTRUYES • CONSTRUÇÃO É BRINCADEIRA SIMULTÂNEAS  
GLEICHZEITIG BAUEN UND SPIELEN • СТРОЙ И ИГРАЙ



# CHOOSE WHAT YOU WANT TO BUILD FIRST! CHOISISSEZ CE QUE VOUS VOULEZ CONSTRUIRE EN PREMIER!

¡ELIGE QUÉ QUIERES CONSTRUIR PRIMERO! • ESCOLHA O QUE VOCÊ QUER CONSTRUIR PRIMEIRO! KINDER KÖNNEN AUSSUCHEN, WAS SIE ZUERST BAUEN WOLLEN! • ВЫБЕРИ, ЧТО ТЫ ХОЧЕШЬ СОБРАТЬ СНАЧАЛА!



**TRY OUR INTERACTIVE BUILDING INSTRUCTIONS!**

**CONSULTEZ NOS INSTRUCTIONS DE CONSTRUCTION INTERACTIVES!**

¡CONSULTA NUESTRAS INSTRUCCIONES DE CONSTRUCCIÓN INTERACTIVAS!  
CONSULTE NOSSAS INSTRUÇÕES DE CONSTRUÇÕES INTERATIVAS!  
MIT INTERAKTIVEN BAUANLEITUNGEN!  
ОЗНАКОМЬСЯ С НАШИМИ ИНТЕРАКТИВНЫМИ ИНСТРУКЦИЯМИ ПО СБОРКЕ!



[UNBOXED.MEGAONSTRUX.COM](https://unboxed.megaconstrux.com)

# CUSTOMIZE YOUR BARBIE FIGURE! PERSONNALISEZ VOTRE FIGURINE BARBIE!

PERSONALIZA TU BARBIE! • PERSONALIZE SUA BARBIE!  
DIE BARBIE-FIGUREN INDIVIDUELL GESTALTEN!  
СДЕЛАЙ СВОЮ ФИГУРКУ БАРБИ УНИКАЛЬНОЙ!



1



2

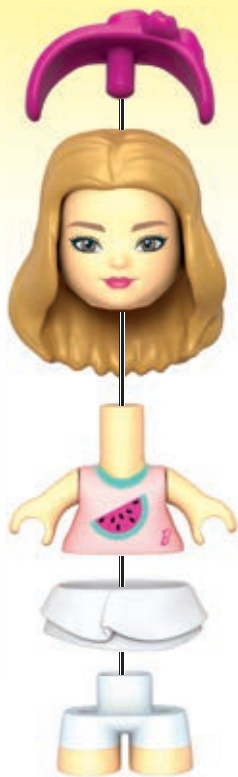

1



2



## LET'S BUILD THE DREAMCAMPER™! CONSTRUISONS LE DREAMCAMPER!

¡CONSTRUYAMOS EL CÁMPER DE BARBIE!  
CONSTRUAMOS O TRAILER DA BARBIE!  
DAS TRAUMWOHNMOBIL BAUEN!  
ДАВАЙ СОБЕРЕМ ВОЛШЕБНЫЙ ДОМ НА КОЛЕСАХ™!





1

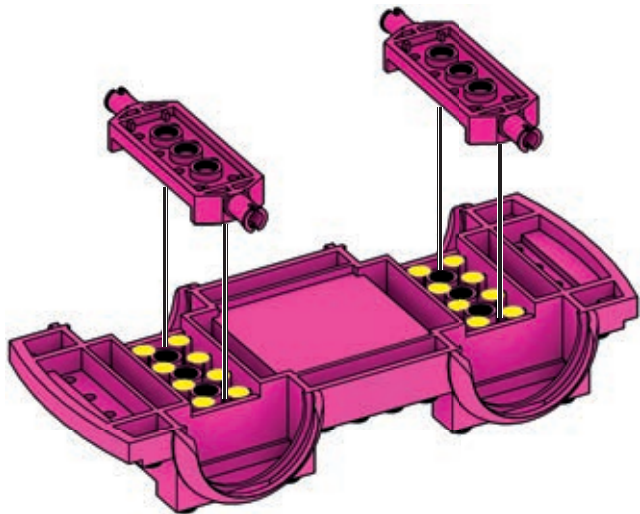
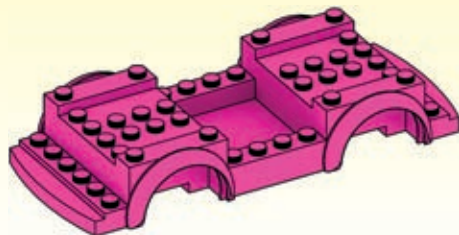
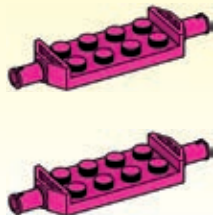

1

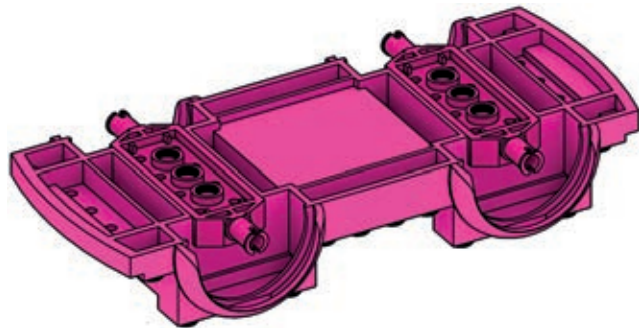

2

2

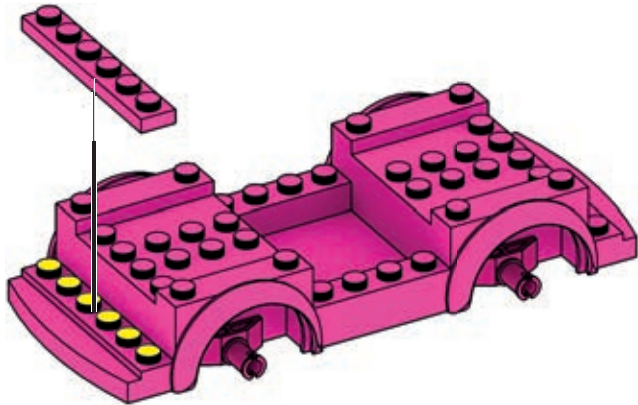

3

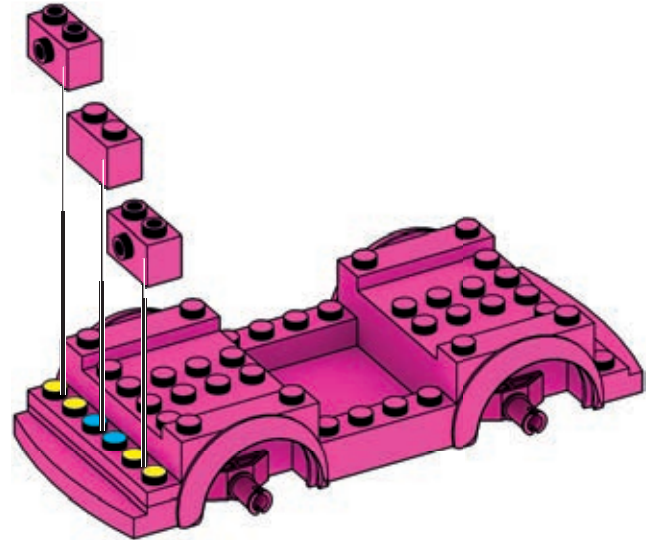

4

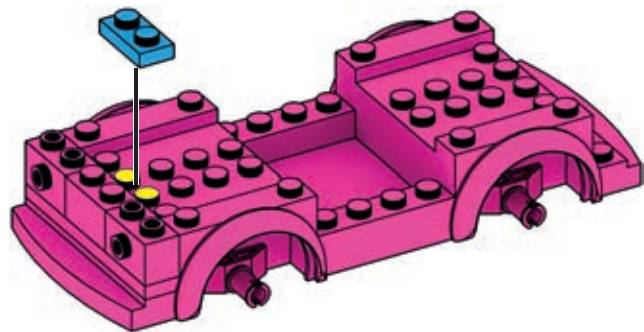

5

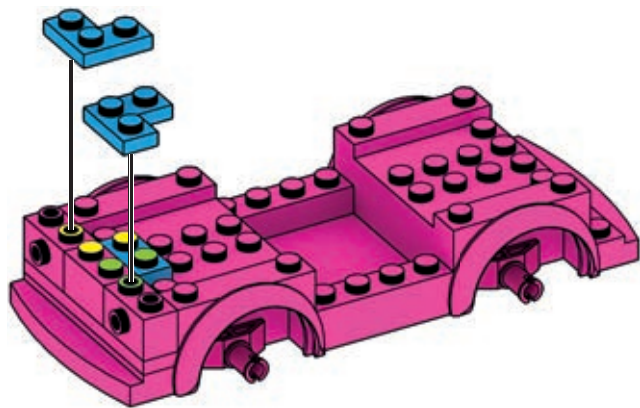



6

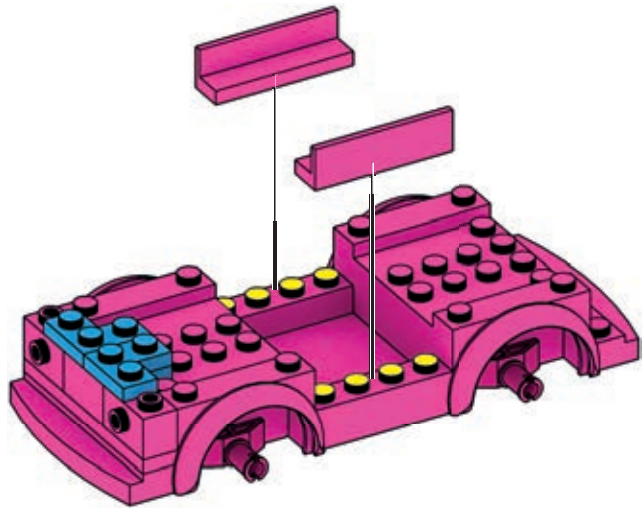
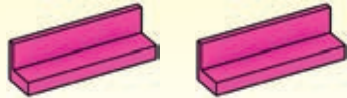

7

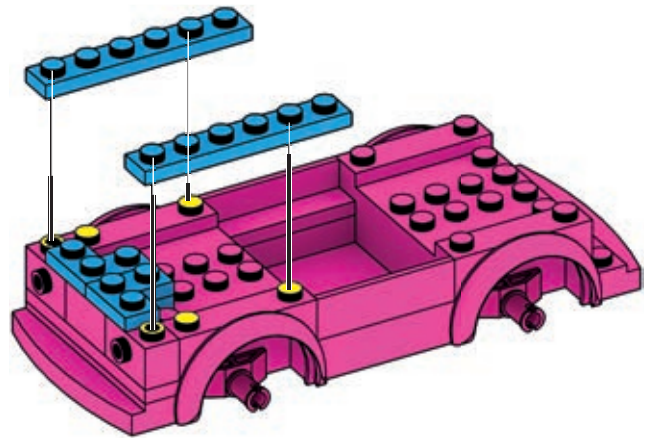
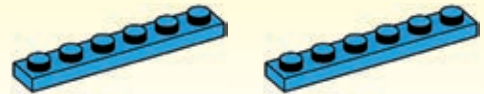

8

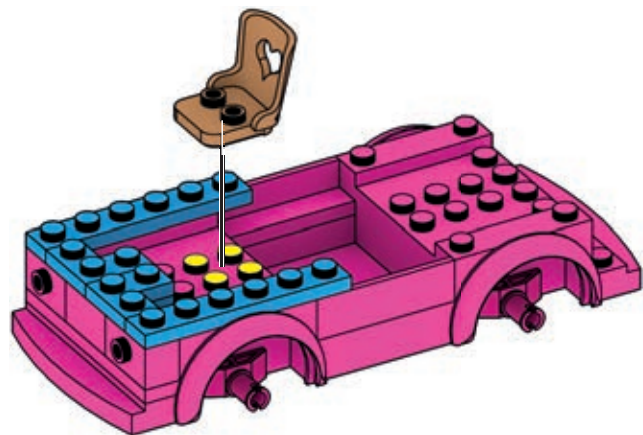

9

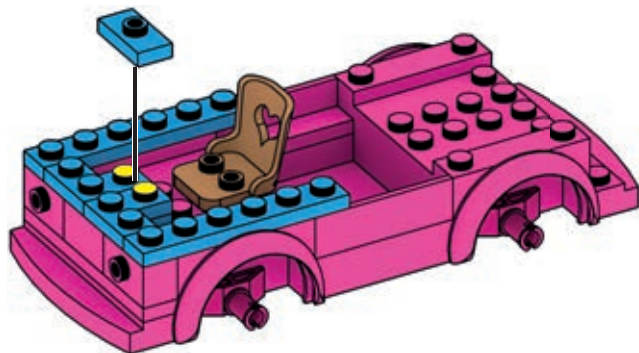

10

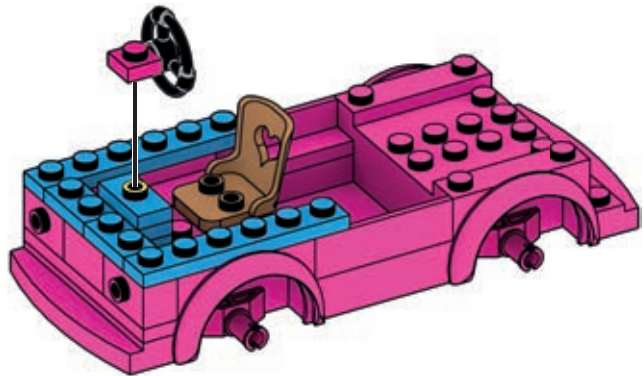
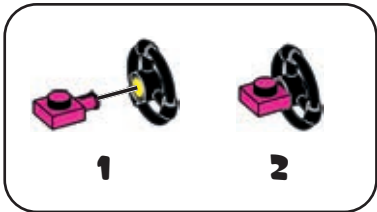

11

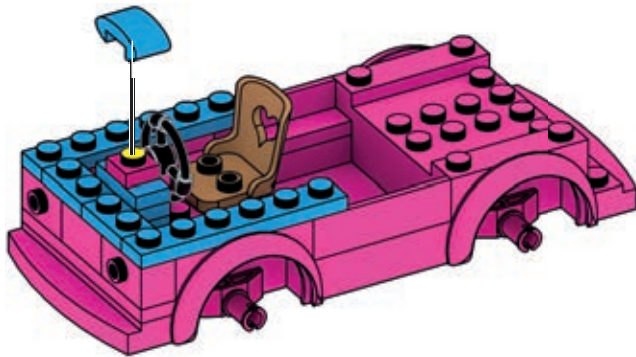

12

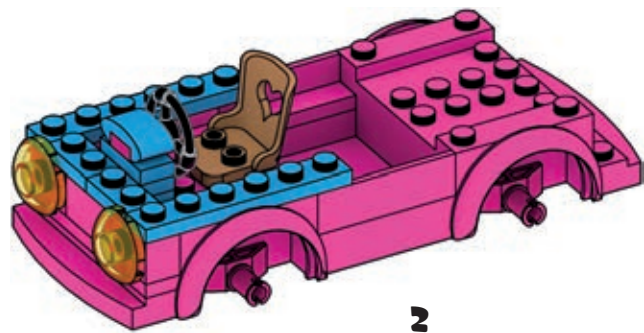
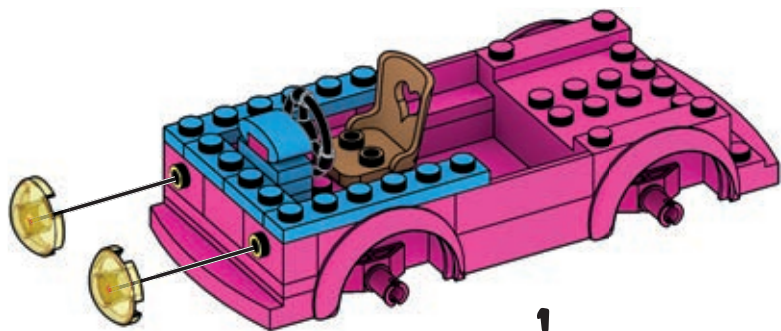

13

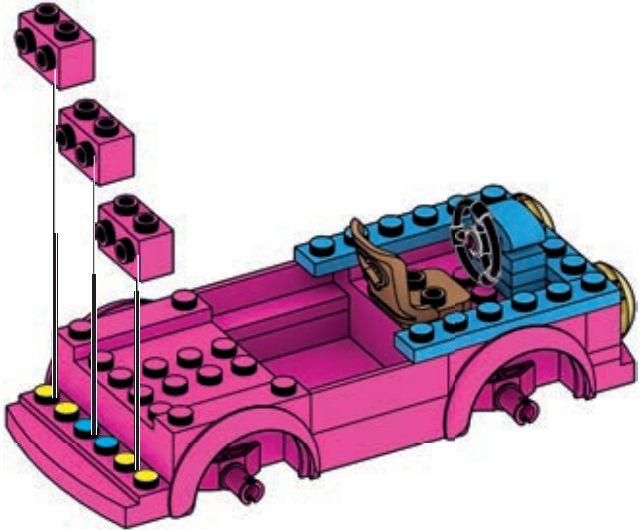

14

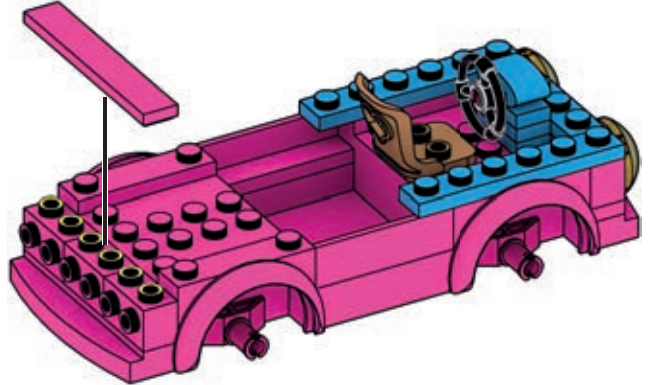

15

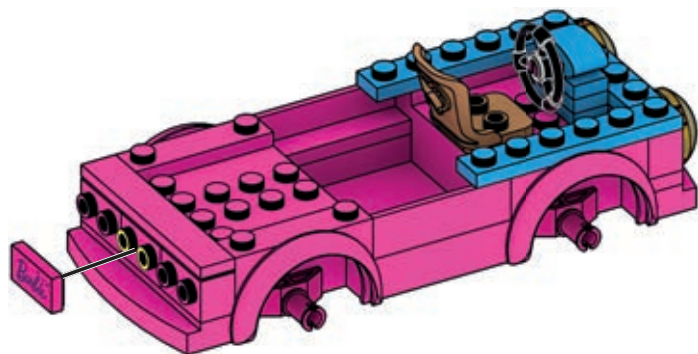

16

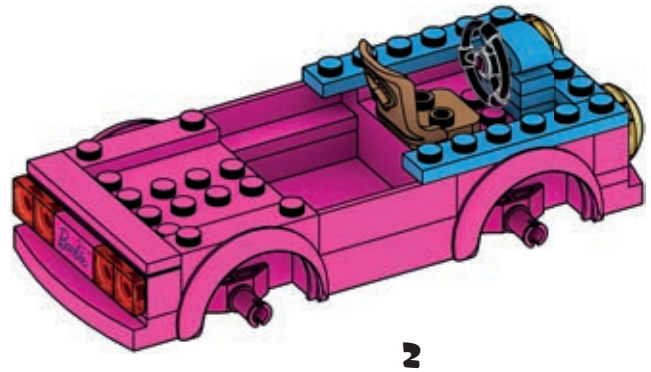
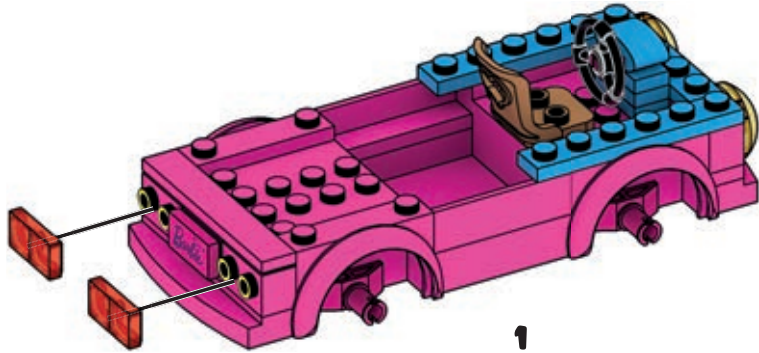

17

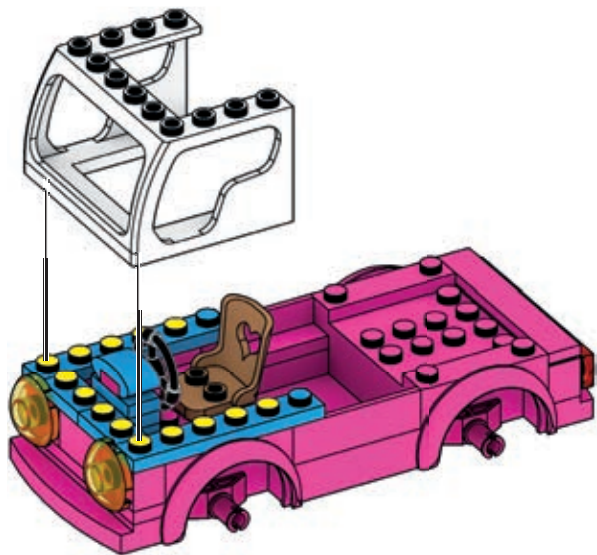
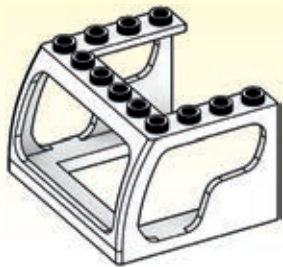

18

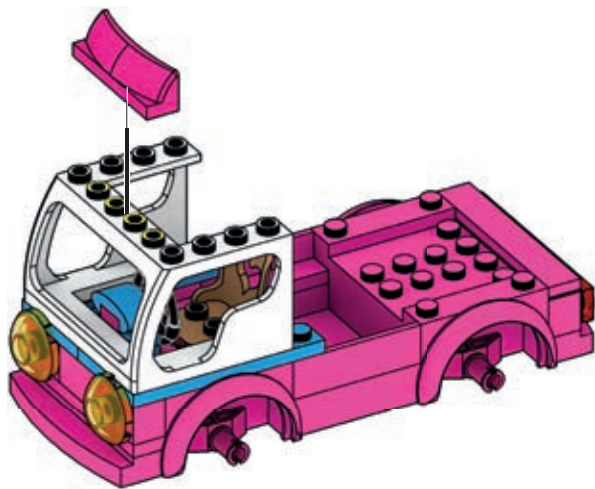



19

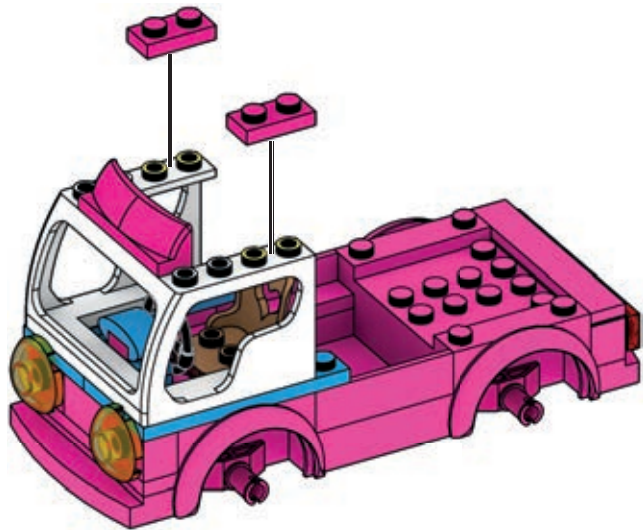

20

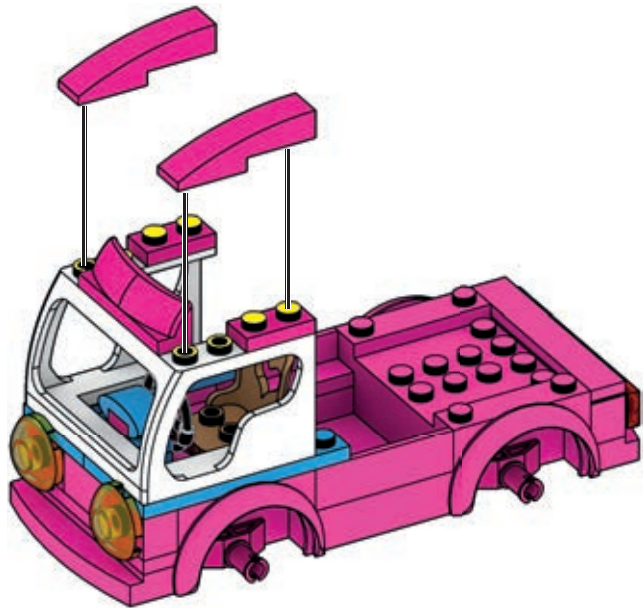
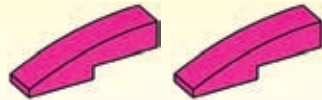

21

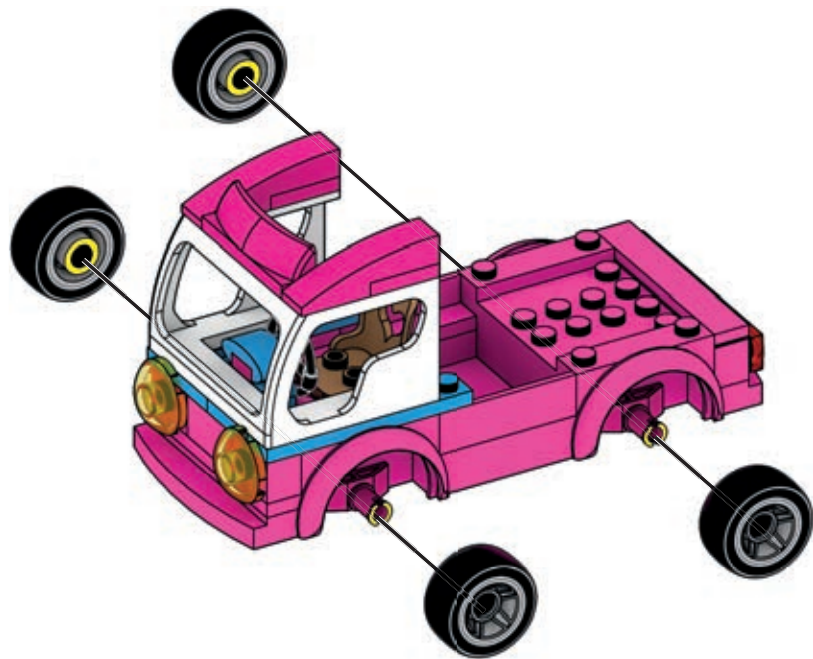

22

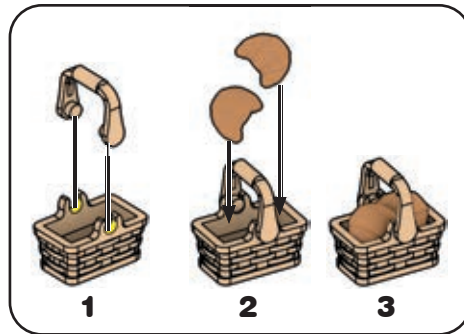

1



2



# CUSTOMIZE YOUR BARBIE FIGURE! PERSONNALISEZ VOTRE FIGURINE BÂRBIE!

PERSONALIZA TU BARBIE! • PERSONALIZE SUA BARBIE!  
DIE BARBIE-FIGUREN INDIVIDUELL GESTALTEN!  
СДЕЛАЙ СВОЮ ФИГУРКУ БАРБИ УНИКАЛЬНОЙ!



1



2



23

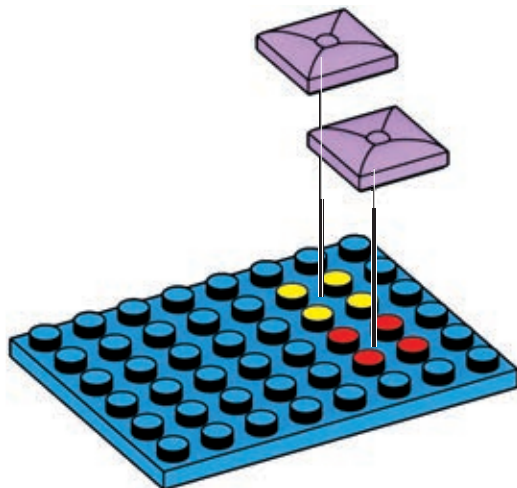
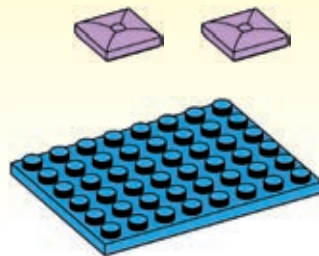

24

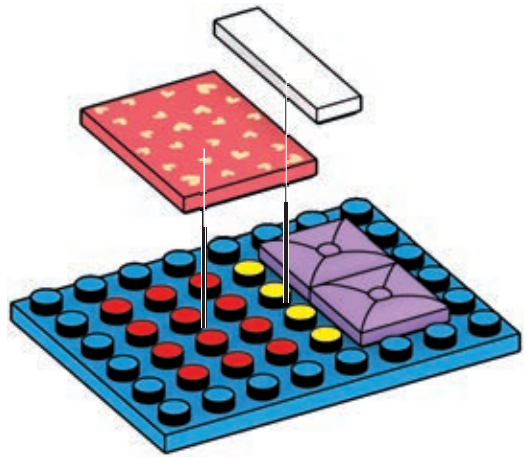

25

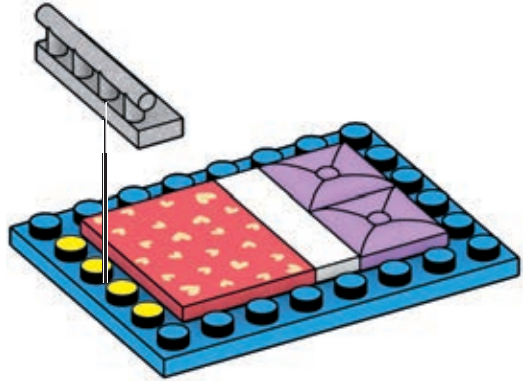
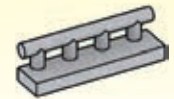

26

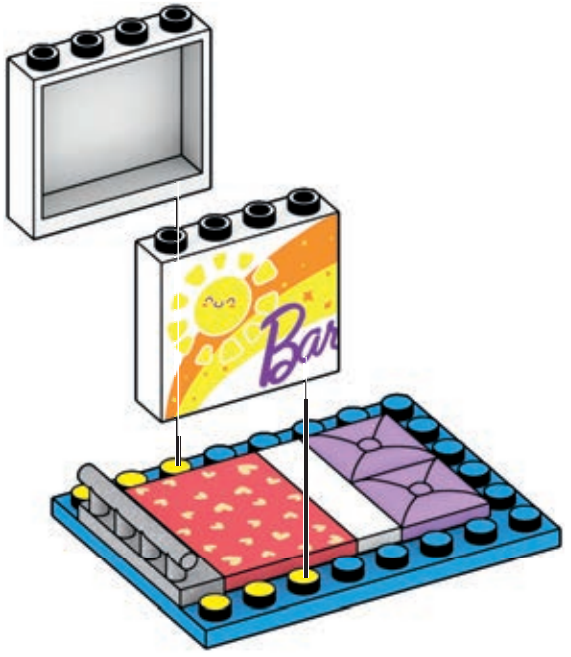

27

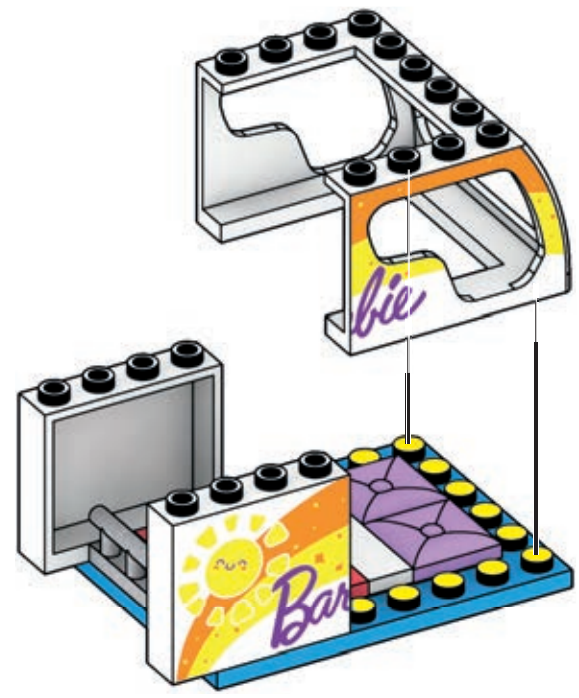
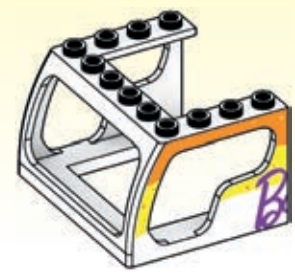

28

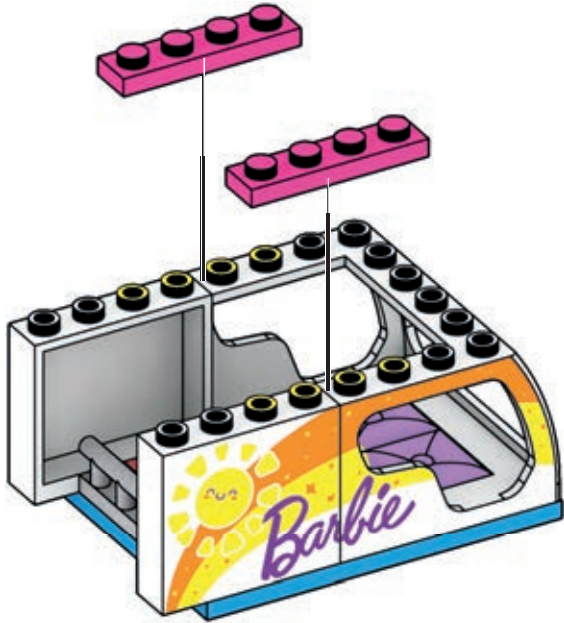

29

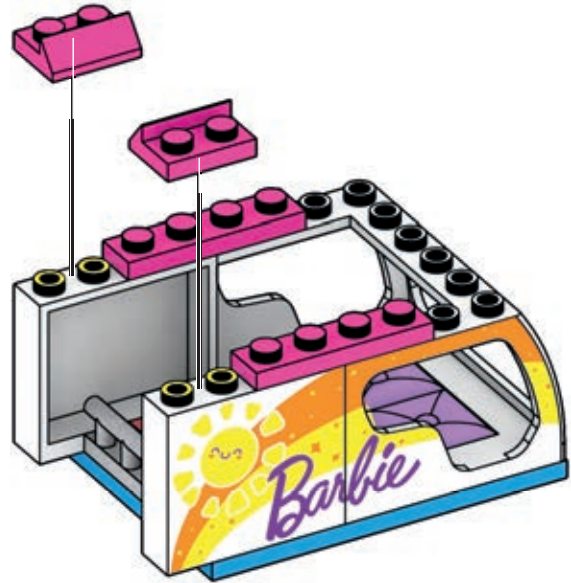

30

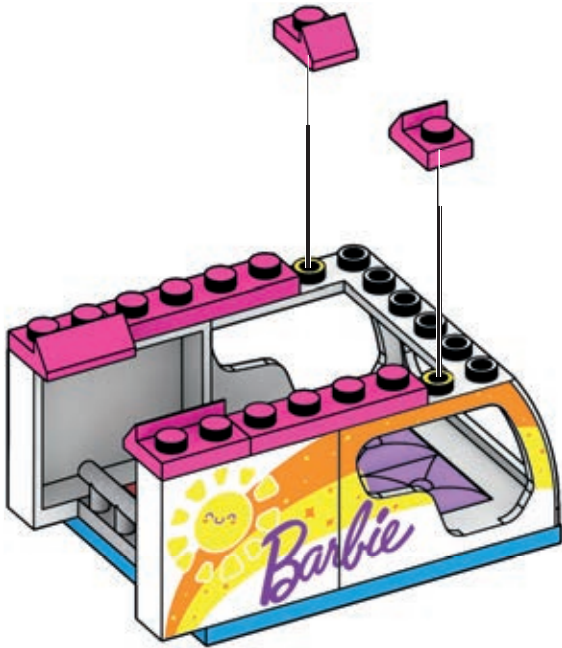

31

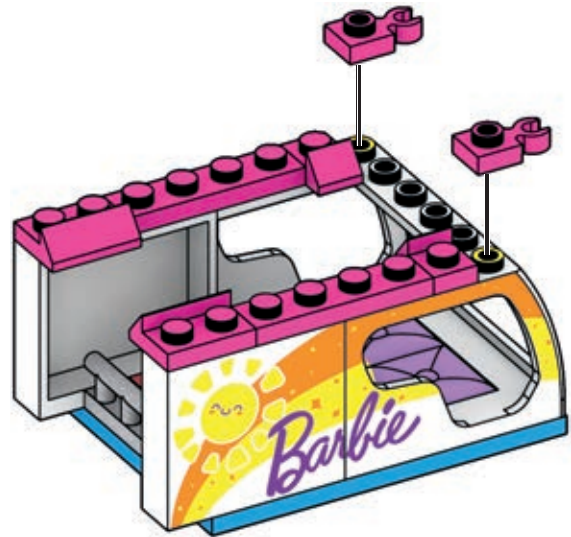



32

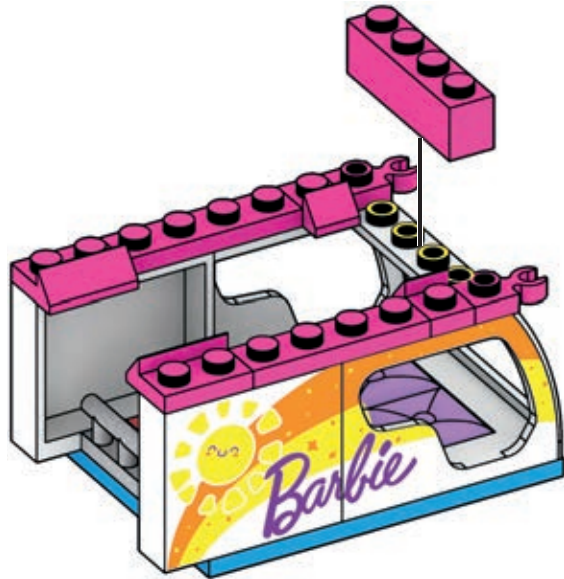
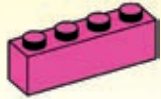

33

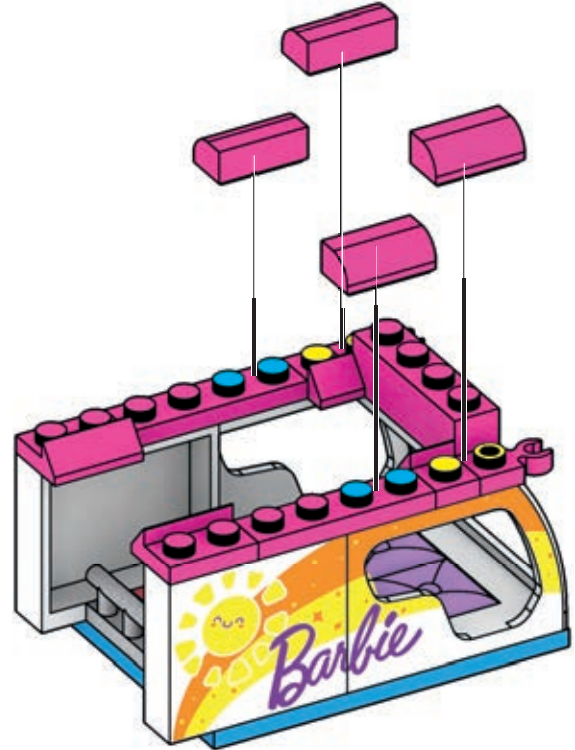

34

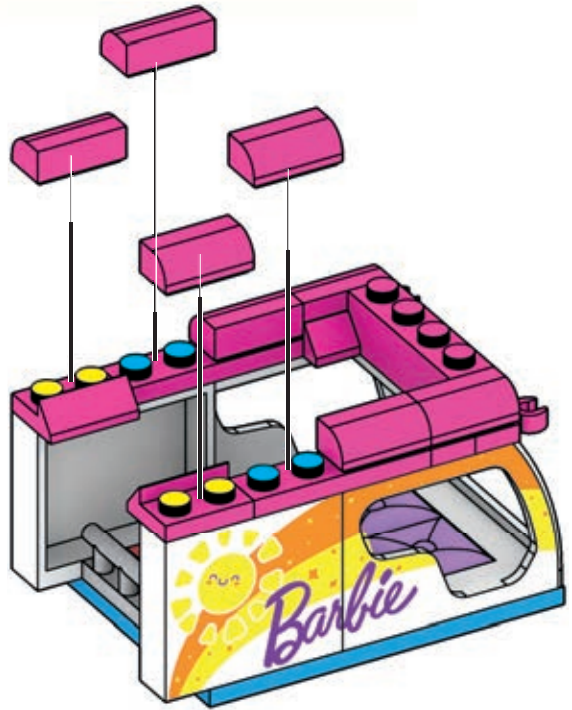
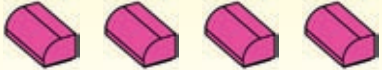

1

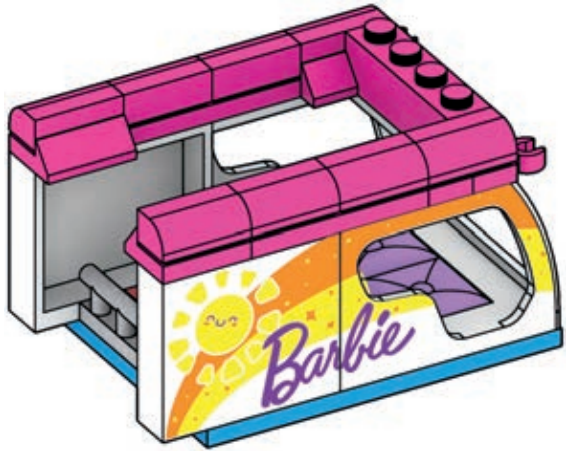

2

35

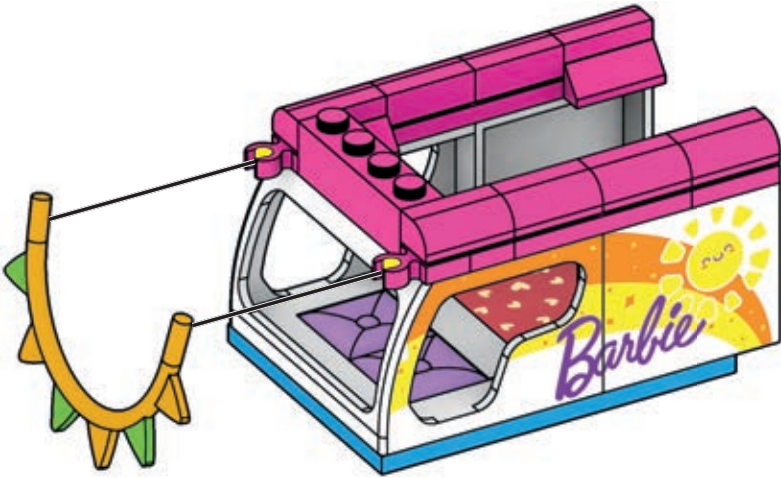

1

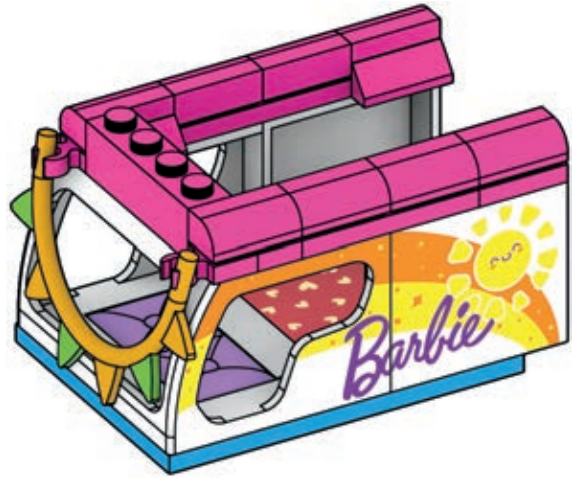

2



# CUSTOMIZE YOUR BARBIE FIGURE! PERSONALISEZ VOTRE FIGURINE BARBIE!

PERSONALIZA TU BARBIE! • PERSONALIZE SUA BARBIE!  
DIE BARBIE-FIGUREN INDIVIDUELL GESTALTEN!  
СДЕЛАЙ СВОЮ ФИГУРКУ БАРБИ УНИКАЛЬНОЙ!



1

2



37

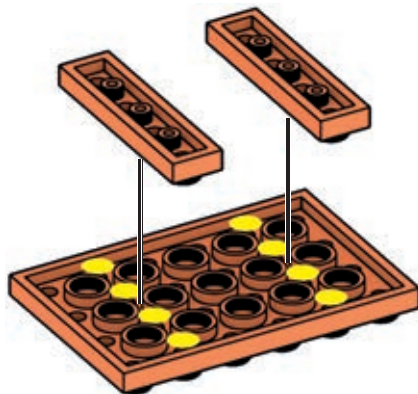
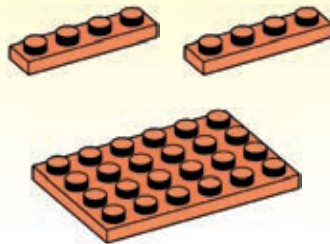

1



2

38

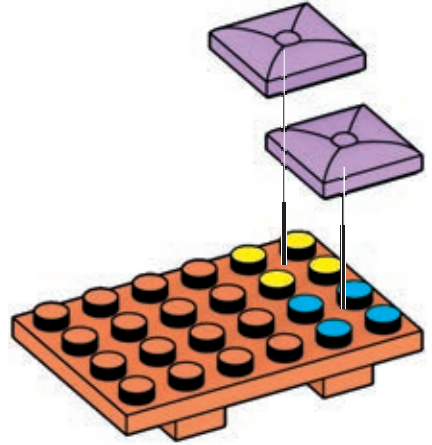

39

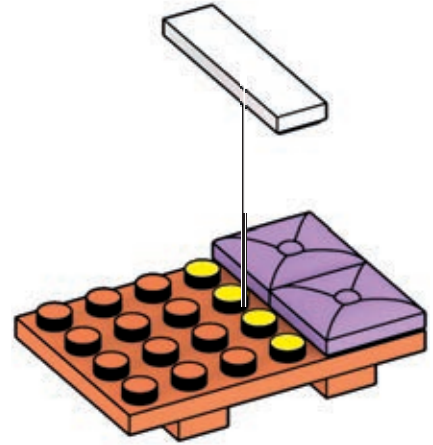

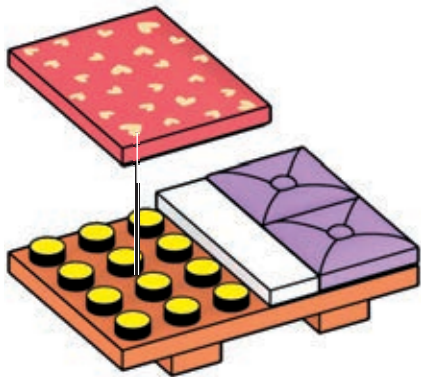

1



2







2



# LET'S BUILD A PICNIC! CONSTRUIONS UN PIQUE-NIQUE!

¡CONSTRUYAMOS UN PICNIC! • CONSTRUAMOS UM PIQUENIQUE!  
EIN PICKNICK BAUEN! • ДАВАЙ СОБЕРЕМ МЕСТО ДЛЯ ПИКНИКА!



# CUSTOMIZE YOUR BARBIE FIGURE! PERSONNALISEZ VOTRE FIGURINE BARBIE!

¡PERSONALIZA TU BARBIE! • PERSONALIZE SUA BARBIE!  
DIE BARBIE-FIGUREN INDIVIDUELL GESTALTEN!  
СДЕЛАЙ СВОЮ ФИГУРКУ БАРБИ УНИКАЛЬНОЙ!

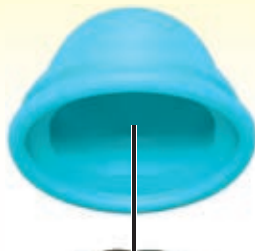

1



2



1



2

42

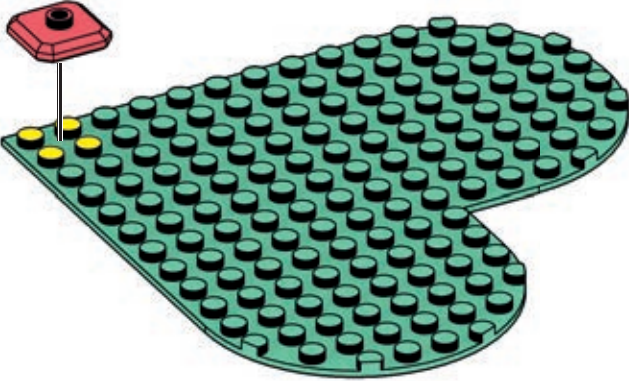
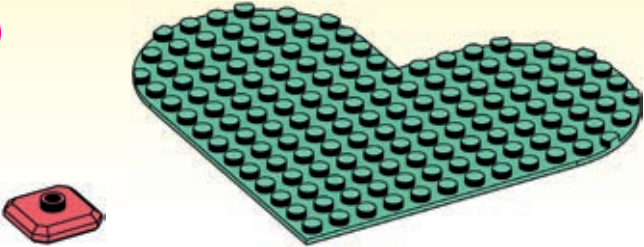

43

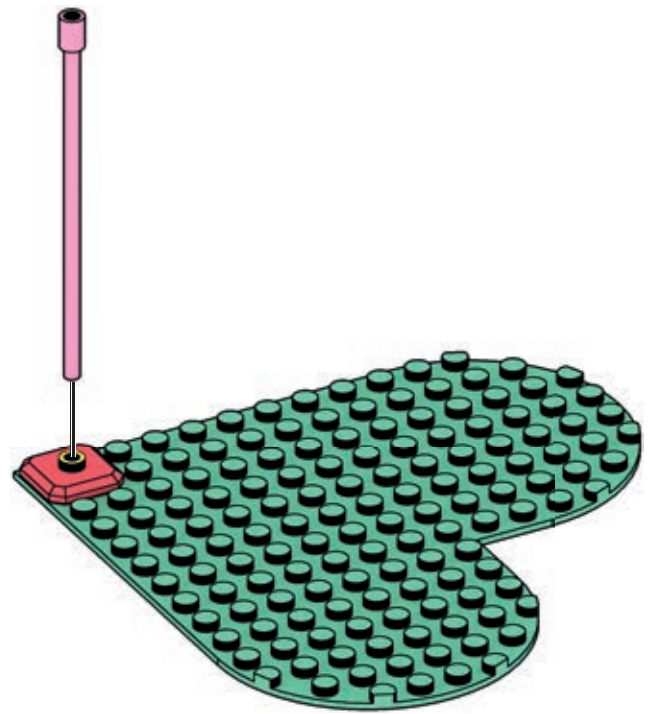

44

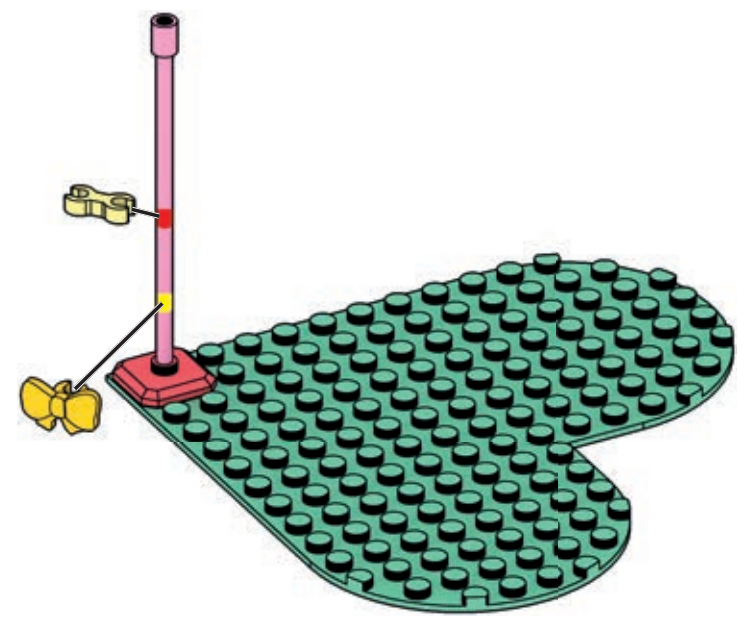
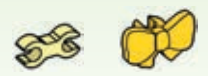

45

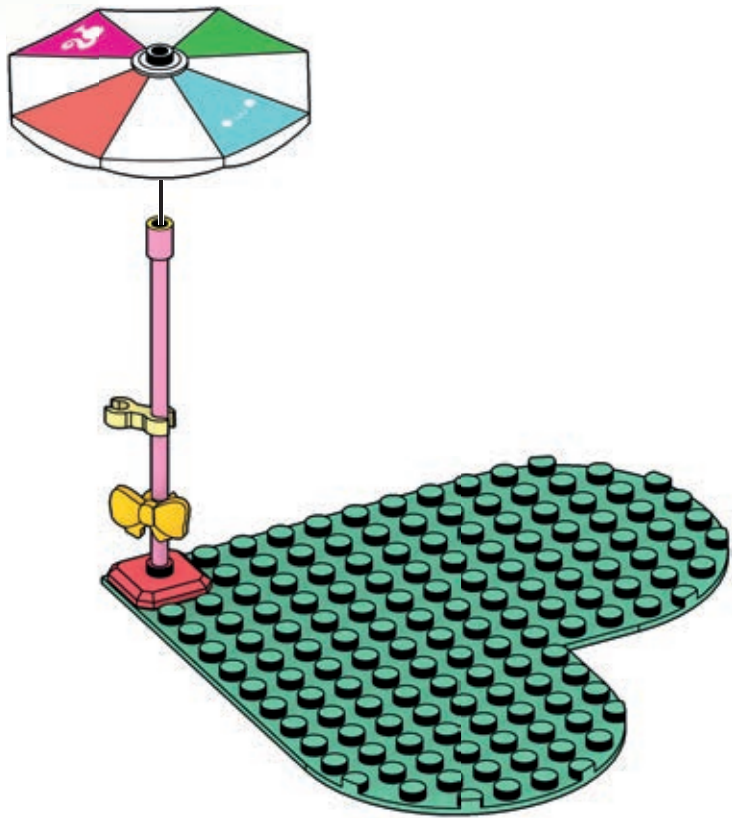
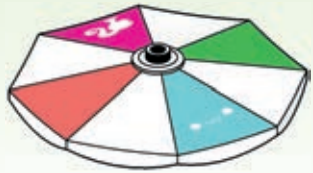

46

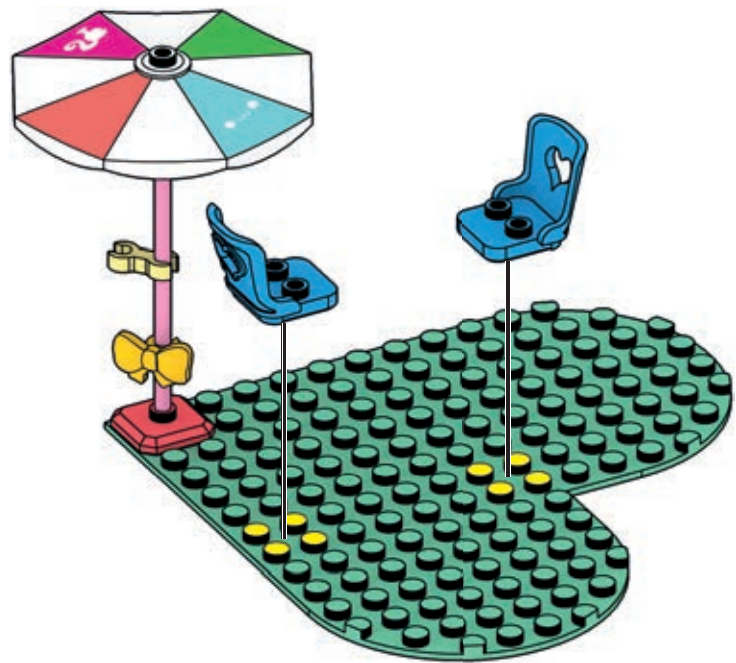

1

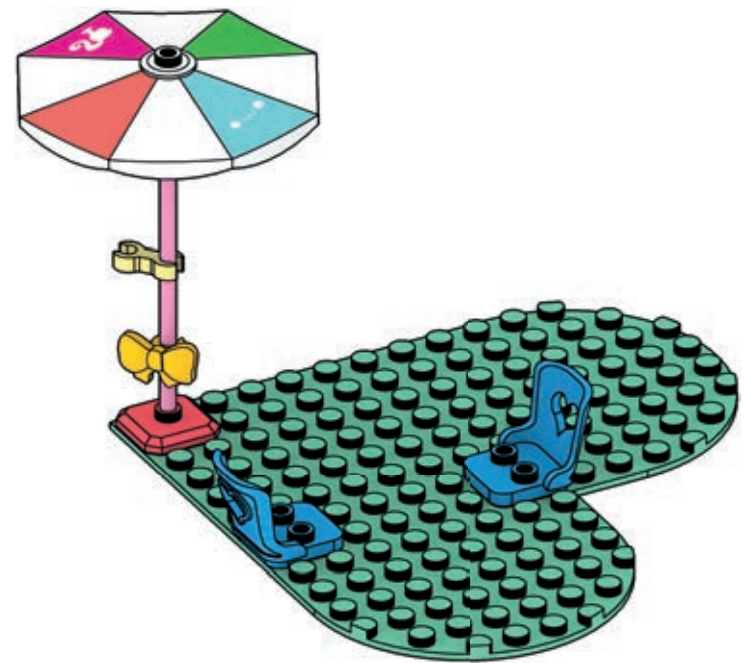

2

47



48

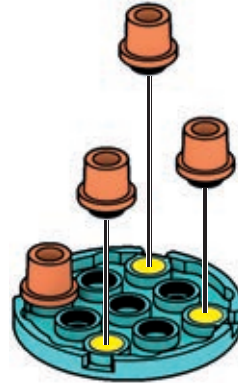

1



2

49

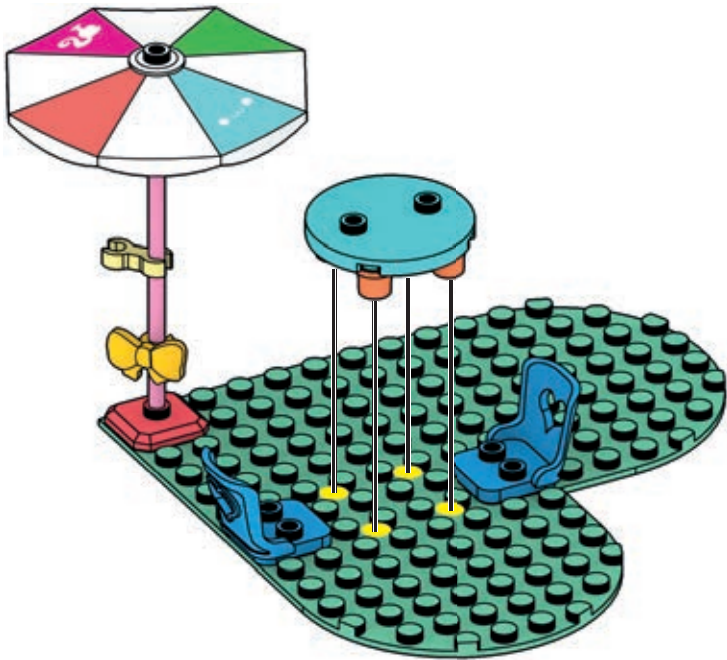

50

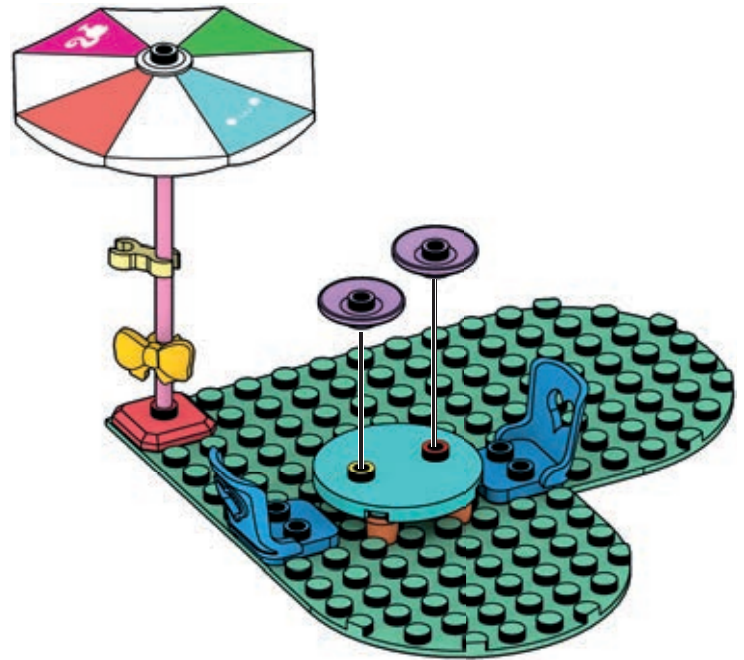



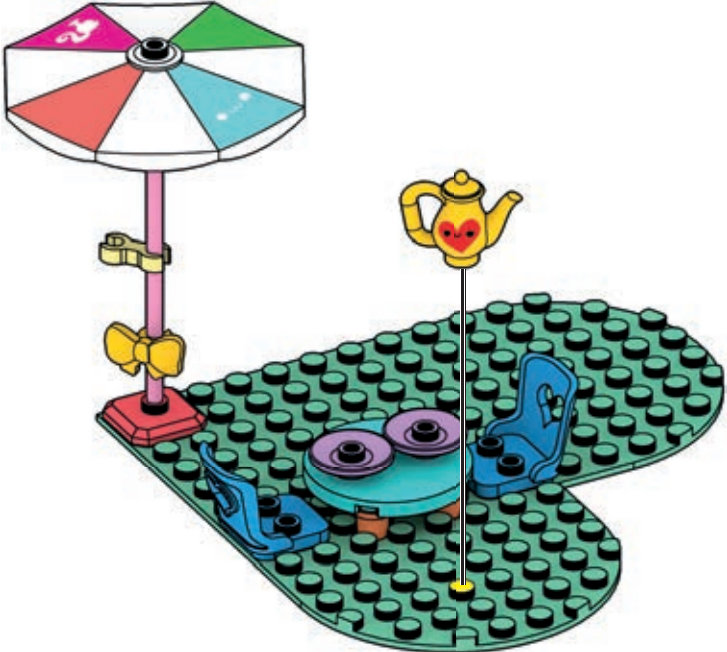

52

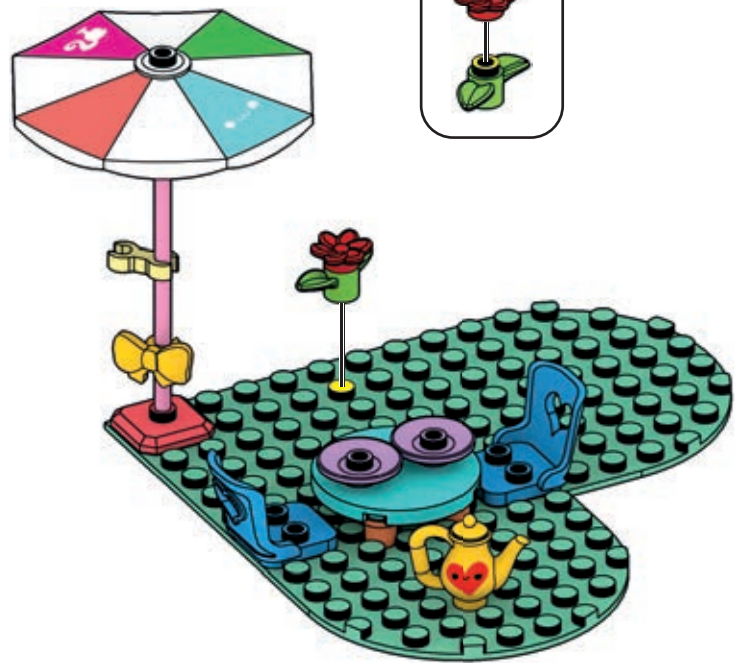

53

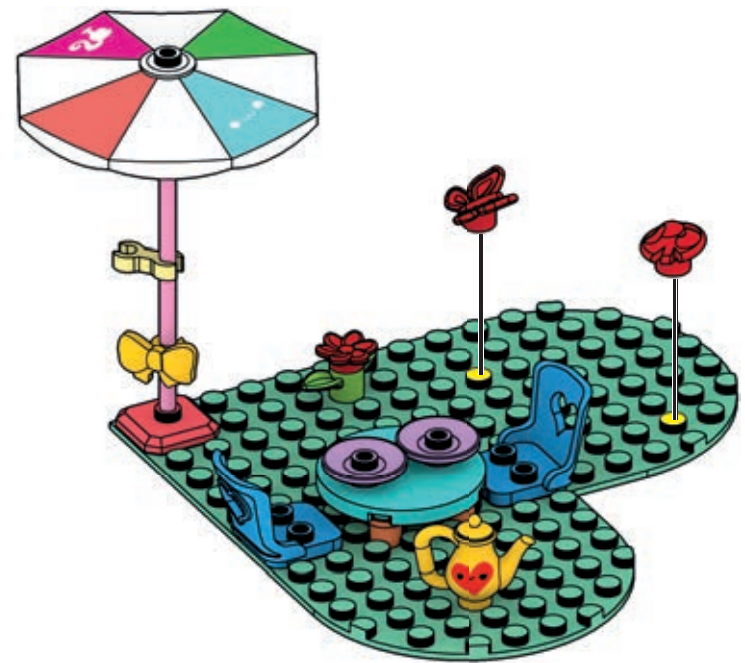

54



55

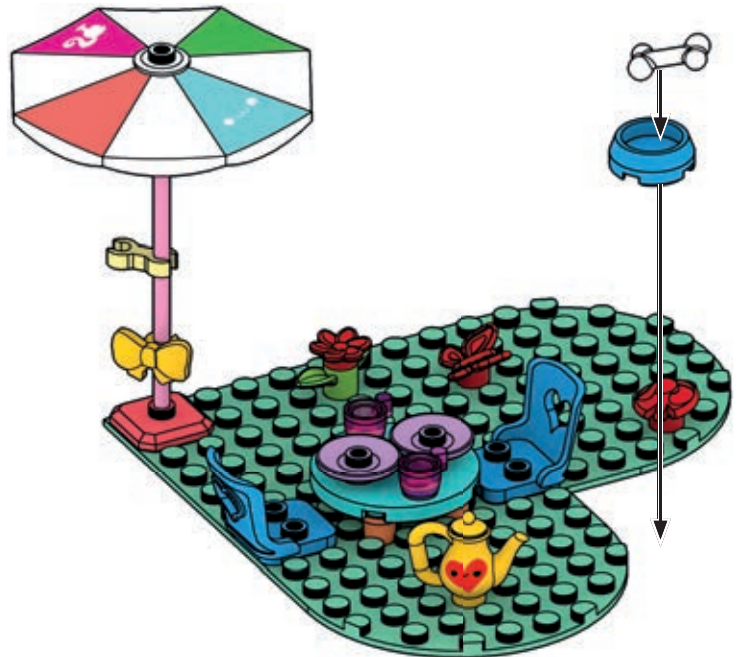



# LET'S PLAY! AMUSONS-NOUS!

¡AJUGAR! • A BRINCAR!  
LASS UNS SPIELEN! • НАИГРАЕМ ИГРУ!



4x  
AM81164AAD

2x  
AM79638AUZ

2x  
AM78800AMR

1x  
AM18592CS

1x  
AM80546ATC

2x  
AM18591GW

1x  
AM72973E

1x  
AM75175AMC

1x  
AM75176AMC

1x  
AM75174AMC

1x  
AM73193BYE

2x  
AM19530GW

1x  
AM78726HT

1x  
AM15555GX

1x  
AS-GWR35-05

2x  
AM76413X

1x  
AM07590GX

1x  
AM09393GX

2x  
AM09393ATC

1x  
AM72972GX

2x  
AM78285ZD

2x  
AM74414NL

1x  
AM78500F

8x  
AM03017GW

2x  
AM09835GW

1x  
AM73009RQ

4x  
AM72956NL

2x  
AM15484GX

3x  
AM17502GW

1x  
AM09013GW

2x  
AM18601GW

1x  
AM78194AMR

1x  
AM78195AMR

1x  
AS-GWR35-11

1x  
AS-GWR35-06

4x  
AS-GWR35-13

2x  
AM81142GX

1x  
AM81142VL

2x  
AM09838E

2x  
AM09593AAD

2x  
AM09593GW

1x  
AM81086ATC

2x  
AM17521GW

1x  
AM01847APG

1x  
AM01087GW

2x  
AM19323ATC

1x  
AS-GWR35-02

1x  
AS-GWR35-07

1x  
AM77622ASU

2x  
AS-GWR35-03

1x  
AM09292GW

2x  
AM09292GX

1x  
AM16331GW

2x  
AM81091ATC

1x  
AM17055AAD

1x  
AS-GWR35-12

1x  
AS-GWR35-04

1x  
AS-GWR35-01

1x  
AM81088E

1x  
AM76192ASX

1x  
AM74678GX

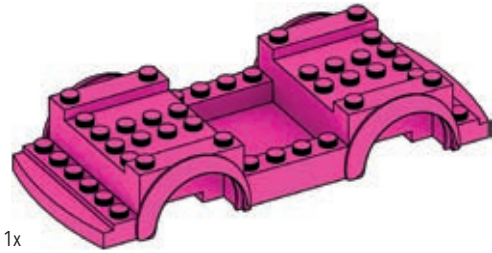

1x  
AM81087GW

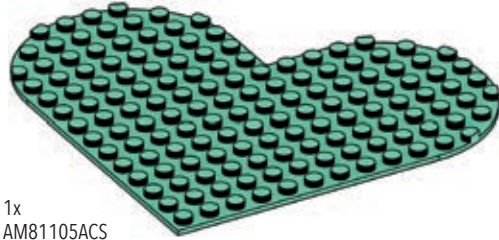

1x  
AM81105ACS



1x  
FIG-GWR35-A



1x  
FIG-GWR35-C



1x  
FIG-GWR35-B



1x  
FIG-GWR35-D



1x  
FIG-GWR35-E



1x  
AM81129AXM



1x  
AM81120KF



1x  
AM81121AXM



1x  
AM81124ATH



1x  
AM81125AXG



1x  
AM81122JF



### Missing pieces? Pièces manquantes?

¿Partes faltantes? • Perdeu peças?  
Fehlen Teile? • Не хватает деталей?

[support.megabrands.com](http://support.megabrands.com)

Mattel Europa B.V., Gondel 1, 1186 MJ Amstelveen, Nederland. Mattel U.K. Limited, The Porter Building, 1 Brunel Way, Slough SL1 1FQ, UK. Mattel France, Parc de la Cerisaie, 1/3/5 allée des Fleurs, 94260 Fresnes Cedex. N° Cristal 0969 36 99 99 (Numéro non surtaxé) ou [www.lesjouetsmattel.fr](http://www.lesjouetsmattel.fr) Mattel Belgium, Trade Mart, Atomiumsquare, Bogota 202 - B 275, 1020 Brussels. Gratis nummer België: 0800 - 16 936 - Gratis nummer Luxemburg: 800 - 22 784 - Gratis nummer Nederland: 0800 - 262 88 35. Deutschland : Mattel GmbH, Solmsstraße 4, D-60486 Frankfurt am Main. Schweiz: Mattel AG, Kirchstrasse 24, CH-3097 Liebefeld. Österreich: Mattel Ges.m.b.H., Campus 21, Liebermannstraße A01 404, A-2345 Brunn/Gebirge. Mattel Italy Srl, Via Bracco, 6-MAC 6, 20159 Milano, Italy. Servizio assistenza clienti: Customersvitalia@mattel.com - Numero verde 800 11 37 11. Mattel España, S.A., Aribau 200. 08036 Barcelona. [cserve.spain@mattel.com](http://cserve.spain@mattel.com) Tel: 902203010 <http://www.service.mattel.com/es>. Mattel East Asia Ltd., Room 503-09, North Tower, World Finance Centre, Harbour City, Tsimshatsui, HK, China. Tel: (852) 3185-6500. Diimport & Diedarkan Oleh: Mattel Continental Asia Sdn Bhd. Level 19, Tower 3, Avenue 7, No. 8 Jalan Kerinchi, Bangsar South, 59200 Kuala Lumpur, Malaysia. Mattel South Africa (PTY) LTD, Office 102 13, 30 Melrose Boulevard, Johannesburg 2196. Distributor: Mattel Poland Sp. z o.o., Warsaw Trade Tower 34 p., ul. Chlodna 51, 00-867 Warszawa. Mattel Australia Pty. Ltd., 658 Church St., Richmond, Victoria, 3121. Consumer Advisory Service - 1300 135 312. Mattel AEBE, Εθνόγυρο Μακαρίου 1, Κτήριο Κ-2, ΤΚ 17561, Πολίαια Ομόλοφο. Mattel Oyuncakçılık Tic. Ltd. Şti. İçerenköy Mah., Erkut Sok. A Blok No:12 Üner Plaza Kat:9-10 34752 Ataşehir İstanbul. Tel: 0216 570 75 00. Импортер/Уполномоченная организация: ООО "МАТЕЛ" Российская Федерация, 105120 Москва, 2-й Сыромятинский переулок, 1; +7 495 287 79 39. Forg.: Mattel Toys Hungary Kft 1139 Budapest Váci út 91. +36 1 270 0223. Mattel Czech Republic s.r.o., The Forum, Václavské nám. 19, 11000 Praha 1. Mattel, 333 Continental Boulevard, El Segundo, CA 90245, USA. Consumer Services: 1-800-465-MEGA (6342). Importado y distribuido por Mattel de México, S.A. de C.V., Miguel de Cervantes Saavedra No. 193, Pisos 10 y 11, Col. Granada, Alcaldía Miguel Hidalgo, C.P. 11520, México, Ciudad de México. R.F.C. MME-920701-NB3. Tels.: 59-05-51-00 Ext. 5206 ó 01-800-463-59-89. Mattel Chile, S.A., Avenida América Vespucio 501-B, Quilicura, Santiago. Tel.: 1230-020-6213. Servicio al consumidor Venezuela: Tel: 0-800-100-9123. Mattel Argentina, S.A., Av. Libertador 1000, Piso 11 - Oficinas 109 y 111, Vicente López - Prov. Buenos Aires. Tel.: 0800-666-3373. Mattel Colombia, S.A., Calle 123#7-07 P5, Bogotá. Tel.: 01800-710-2069. Mattel Perú, S.A., Av. Juan de Arona # 151, Centro Empresarial Juan de Arona, Torre C, Piso 7, Oficina 704, San Isidro, Lima 27, Perú. RUC: 20425853865. Reg. Importador: 02350-12-JUE-DIGESA. Tel.: 0800-54744. E-mail Latinoamérica: [servicio.clientes@mattel.com](mailto:servicio.clientes@mattel.com). Mattel do Brasil Ltda.- CNPJ: 54.558.002/0001-20 - Rua Verbo Divino, 1488 - 2º. Andar - 04719-904 - Chácara Santo Antônio - São Paulo - SP - Brasil. Serviço de Atendimento ao Consumidor: fone 0800 575 0780. E-mail: [sac.matteldobrazil@mattel.com](mailto:sac.matteldobrazil@mattel.com)

⚠ WARNING :  
CHOKING HAZARD. - Small parts.  
Not for children under 3 years.

⚠ ATTENTION :  
DANGER D'ÉTOUFFEMENT. - Présence de petits éléments.  
Ne convient pas aux enfants de moins de 3 ans.

⚠ 警告:  
のどにつまる危険 小さな部品が含まれています  
3歳以下の子供には与えないで下さい。

⚠ تحذير:

غير مناسبة للأطفال دون 36 شهراً - قطع صغيرة.

⚠ 警告!  
不适合3岁以下儿童使用。  
内含小零件。

ADVERTENCIA: PELIGRO DE ATRAGANTAMIENTO. Juguete no recomendado para menores de 3 años, porque contiene piezas pequeñas que podrían provocar asfixia en caso de ser ingeridas o inhaladas por el/la niño/a.

ATENÇÃO! Não indicado / não recomendável para crianças menores de 3 (três) anos por conter parte(s) pequena(s) que pode(m) ser engolid(a)s ou aspirada(s) podendo provocar asfixia.

AVVERTENZA: Contiene pezzi di piccole dimensioni.

ACHTUNG: Kleine Teile.

OSTRZEŻENIE: Małe części. Niebezpieczeństwo zadławienia.

WAARSCHUWING: Kleine onderdelen

ПРЕДУПРЕЖДЕНИЕ: Мелкие детали.

ADVARSEL: Indeholder små dele.

VARNING: Smådelar

ADVARSEL: Små deler

VAROITUS: Pieniä osia

ΠΡΟΣΟΧΗ: Περιλαμβάνονται μικρά κομμάτια.

UYARI: Küçük parçalar.

UPOZORNENIE: Malé diely

UPOZORNENIE: Malé diely

FIGYELMEZTETÉS: Kis alkatrészek.





CONJUNTOS DE CONSTRUÇÃO  
BAUSETS • НАБОРЫ КОНСТРУКТОРОВ



GWR32



GWR34

**MORE TO COLLECT!**  
**ENCORE PLUS À COLLECTIONNER!**

IMÁS PARA COLECCIONAR! • MAIS PARA COLECIONAR!  
MEHR ZUM SAMMELN! • СОБЕРИ БОЛЬШЕ!



GWR79



GWR32



GWR79



GWR34

Set(s) sold separately and subject to availability. / Ensemble(s) vendu(s) séparément. Certains produits peuvent ne pas être commercialisés. / Se vende(n) por separado y está(n) sujeto(s) a disponibilidad. / Conjunto(s) vendido(s) em separado e sujeito(s) à disponibilidade. / Set in vendita separatamente, secondo disponibilità. / Das/Die Set(s) sind separat erhältlich. / Zestaw(y) sprzedawany(e) oddzielnie w zależności od dostępności. / Set(s) apart verkrijgbaar en afhankelijk van beschikbaarheid. / Набор(ы) продаются отдельно, при наличии. / Sæt sælges separat og så længe lager haves. / Seten säljs separat så länge lagret räcker. / Settett/settene selges separat så langt lageret rekker. / Pakkaus/pakkaukset myydään erikseen, saatavuus voi vaihdella. / Το(α) σετ πωλούνται ξεχωριστά και ανάλογα με τη διαθεσιμότητα. / Setler ayrı olarak satılır ve stoklarla sınırlıdır. / Set (sety) se prodává (prodávají) samostatně dle aktuální nabídky. / Súprava/-y sa predáva(jú) samostatne a podľa dostupnosti. / A készlet(ek) külön kapható(k), az elérhetőség változhat. / セット商品は別売りになります。在庫状況は別途ご確認をお願いします。 / بیاج المجموعه او المجموعات علی حده وتخضع لتوافرها. / 每套单独发售，按供货情况决定。

每套单独发售，按供货情况决定。

ADVENTURE DREAMCAMPER™ | AVENTURE EN CAMPING-CAR DE RÊVE | SUPER ABENTUEER-CAMPER | CAMPER DEI SOGNI | AVONTUURLIJKE DROOMCAMPER | CAMPER DE AVENTURAS TRAILER DE AVENTURAS | WYMARZONY CAMPER | LAKÓKÖCSIS KALAND | ПРИКЛЮЧЕНИЯ В ДОМЕ НА КОЛЕСАХ | ΟΝΕΙΡΕΜΕΝΟ ΤΡΟΧΟΣΠΙΤΟ | BARBIE'NIN MEGA KARAVANI™ | DREAMCAMPER™ مغامرة

© 2020, MEGA Brands &™ MEGA Brands; BARBIE and associated trademarks and trade dress are owned by and used under license from Mattel. BARBIE ainsi que les marques et designs y afférents appartiennent à, et sont utilisés sous licence de Mattel.

Printed in China / Imprimé en Chine AD-GWR35-01

1186 MJ, 1, NL

Mattel Canada Inc. Mississauga, Ontario L5R 3W2.  
MADE IN CHINA. FABRIQUÉ EN CHINE. FABRICADO NA / HECHO EN CHINA.  
ИЗГОТОВЛЕНО В КИТАЕ. ÇIN'DE ÜRETİLMİŞTİR. صنع في الصين

