

# Artemide®

## Tolomeo mega

design  
M. De Lucchi  
G. Fassina

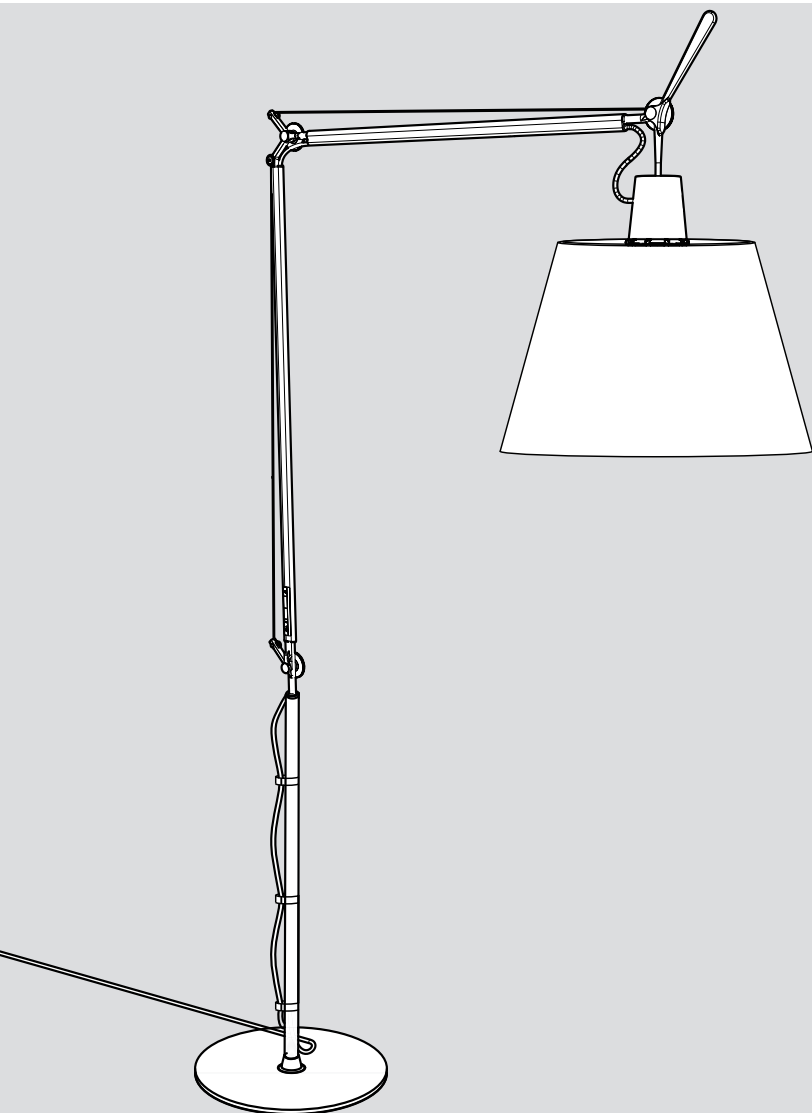



i

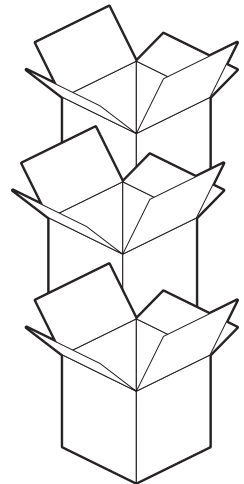
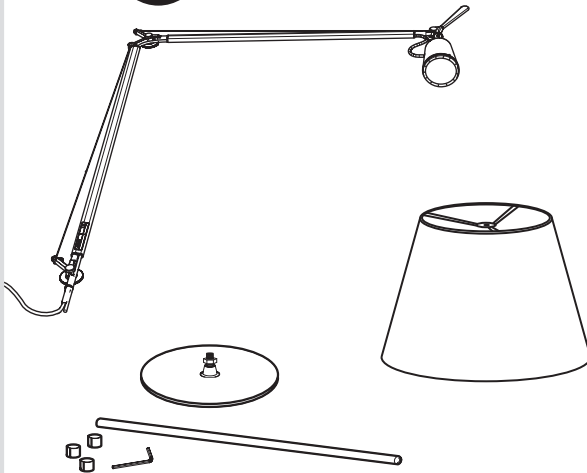
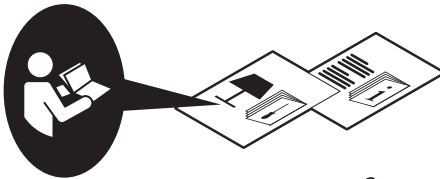
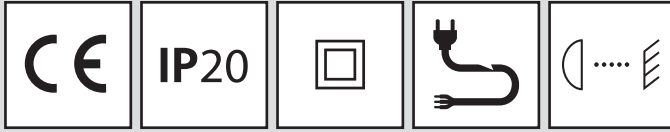

1

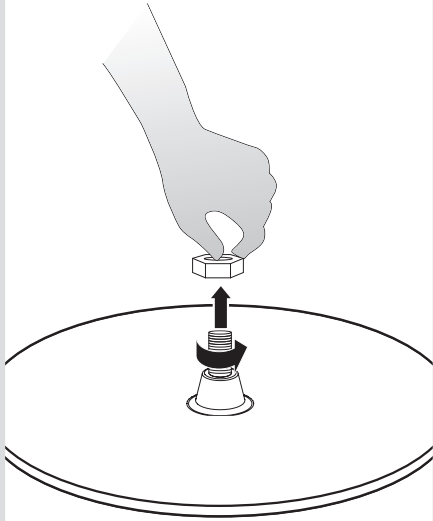

2

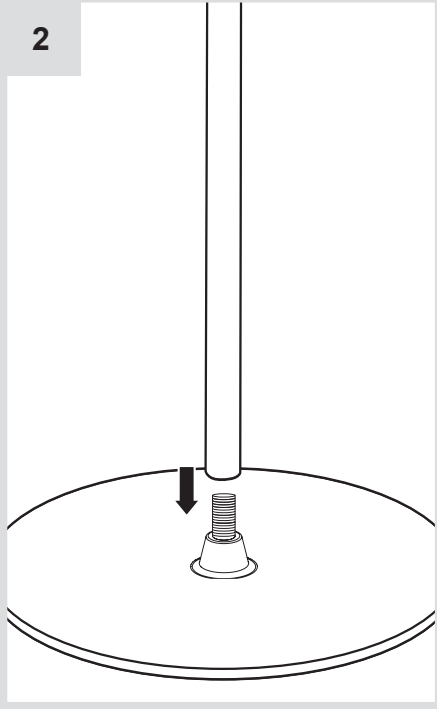

3

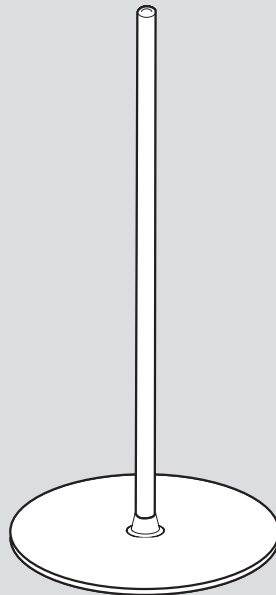
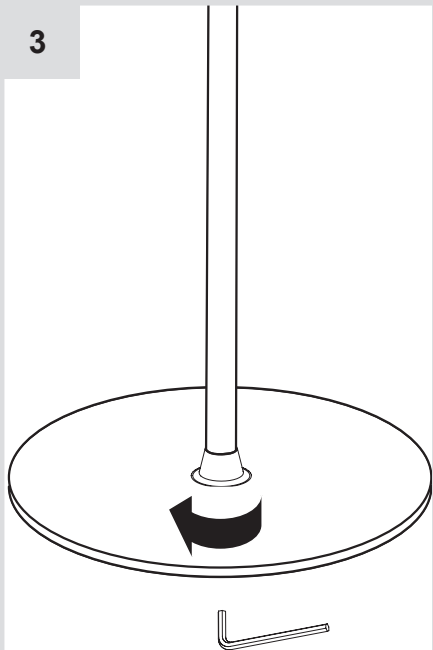

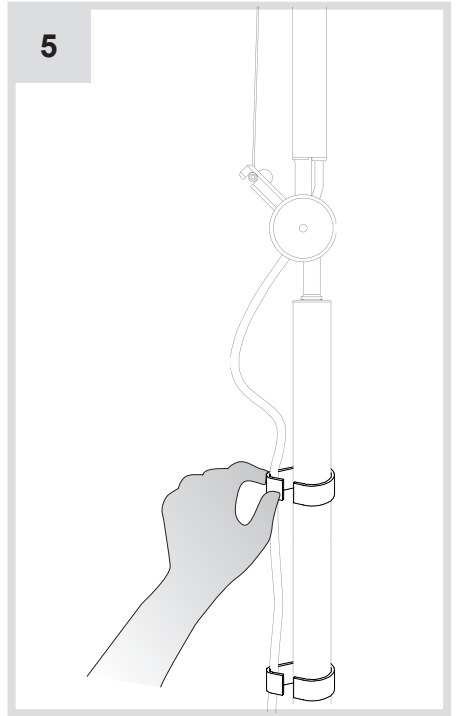
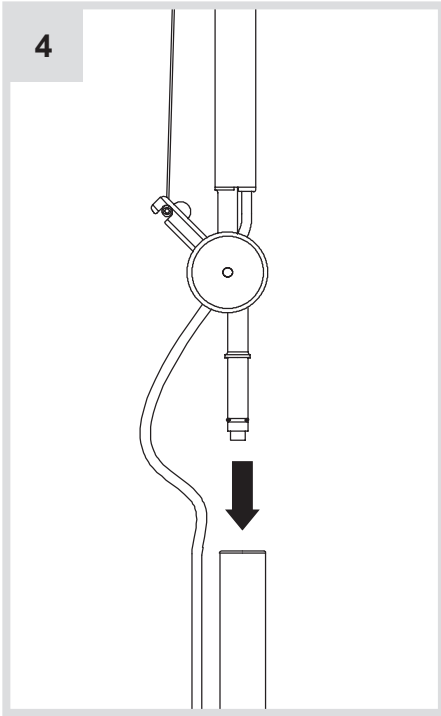

6

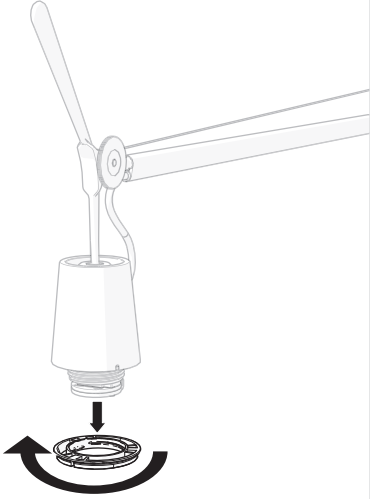

7

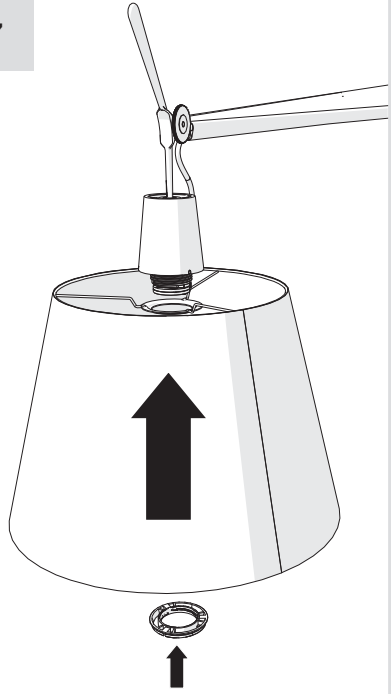

8

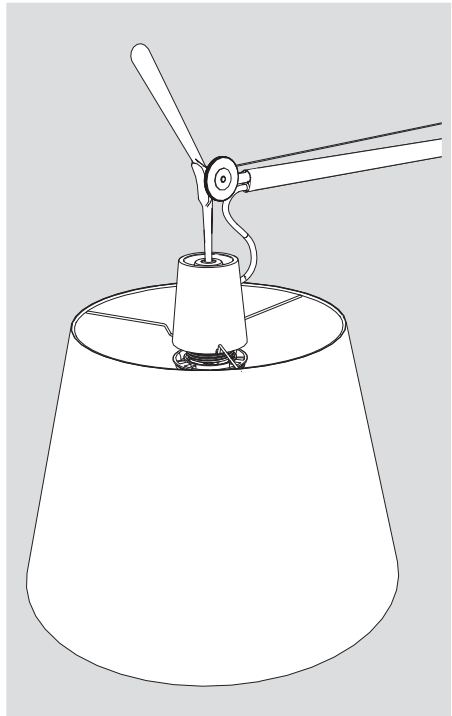
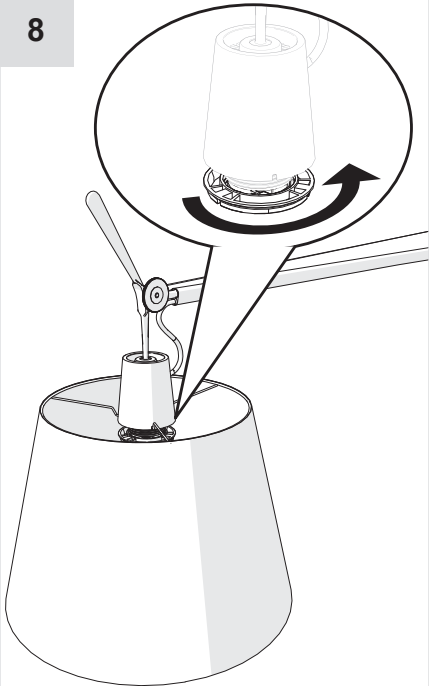

9

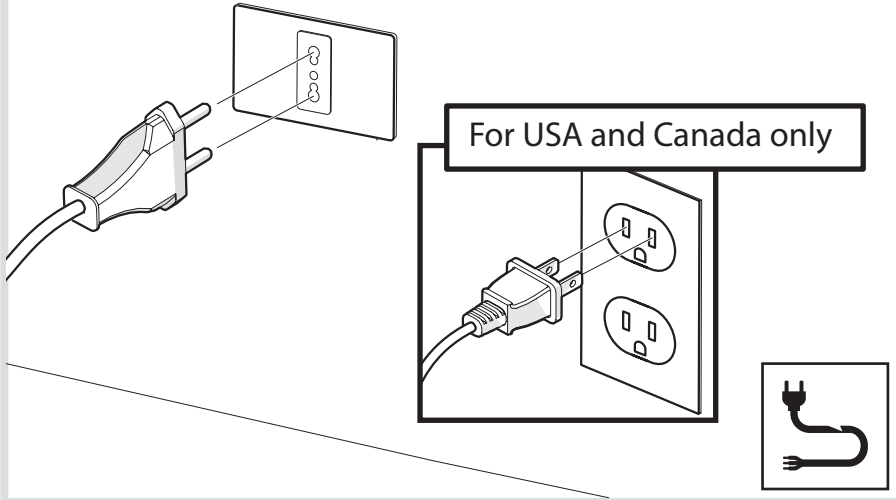

i



**i**

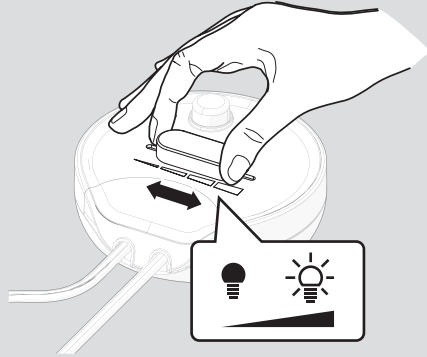
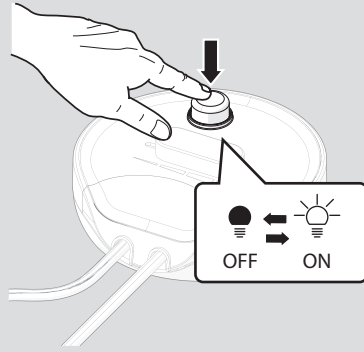

**i**

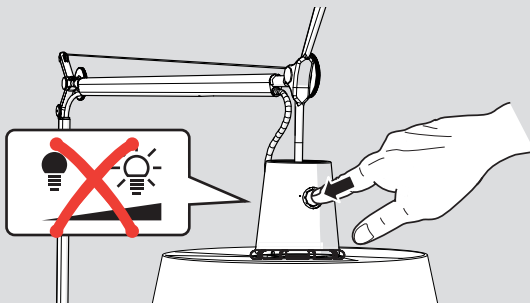
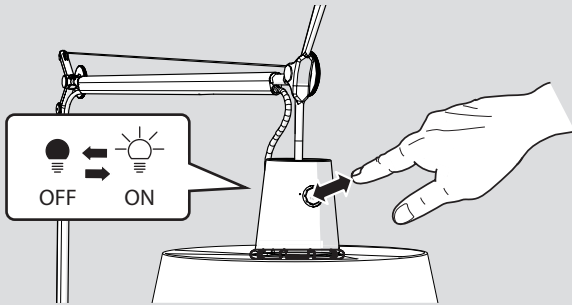

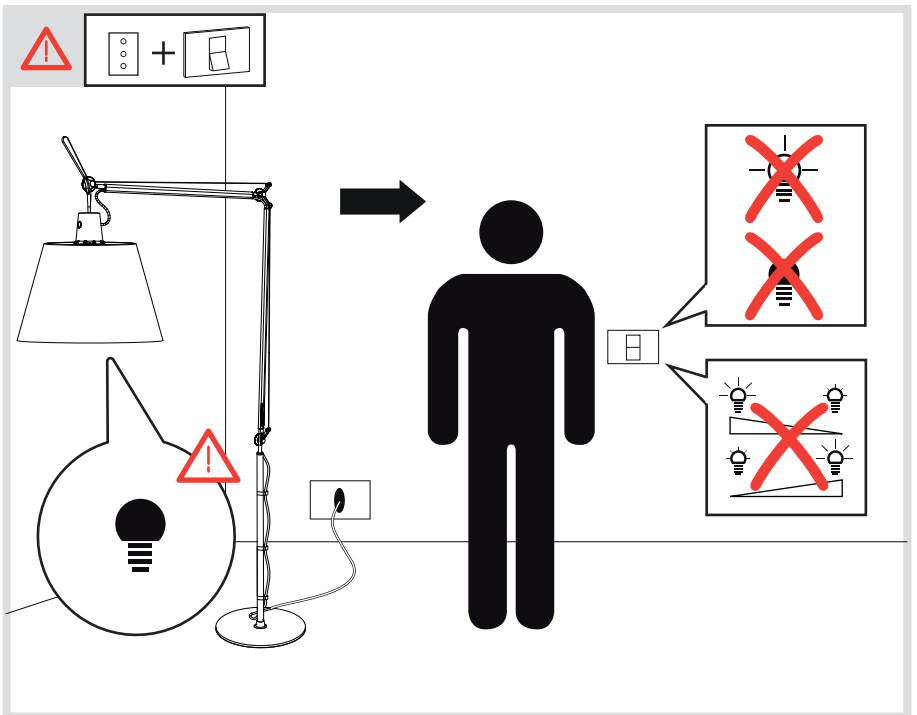
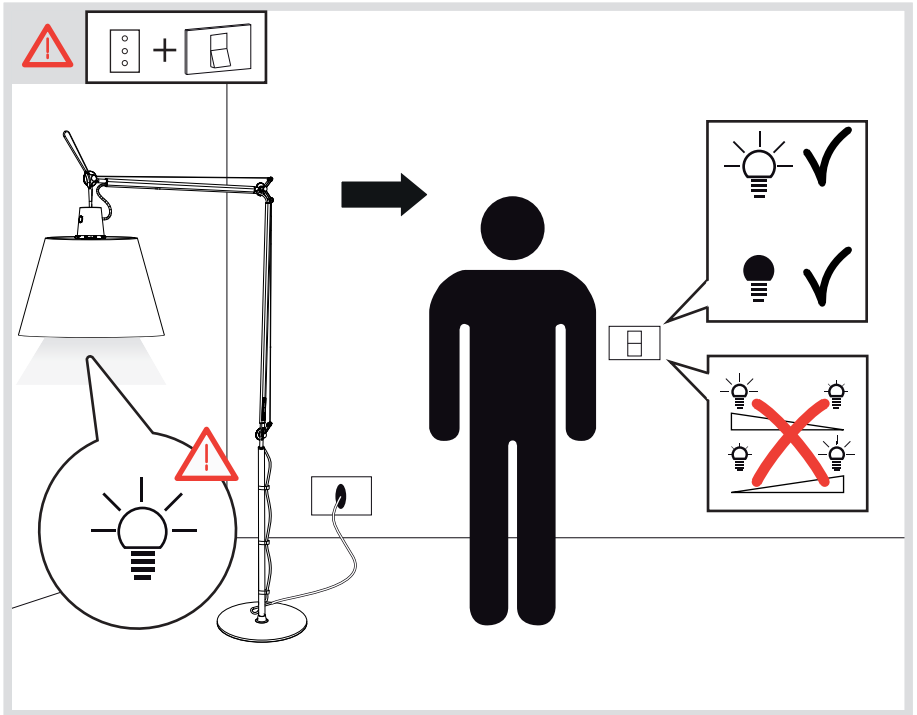





**i**

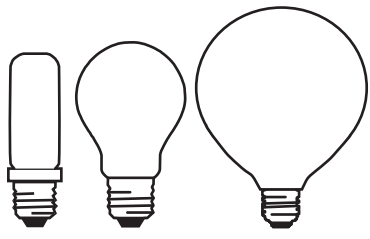
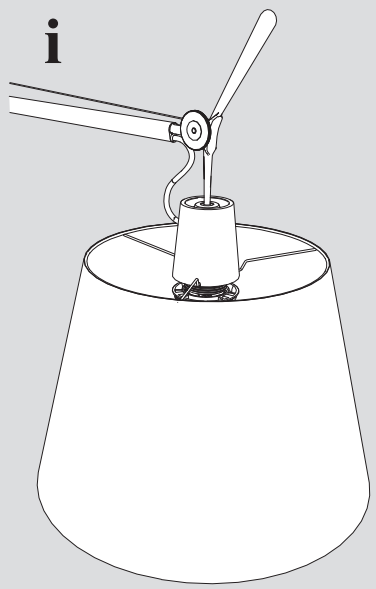

max  
70 g

32

**MAX 21W LED E27**

36

**MAX 150W E27**

42

**MAX 150W E27**

for USA/CANADA only

32

**MAX 21W E26**  
cULus SBLED LAMP

36

**MAX 150W E26**  
type A

42

**MAX 150W E26**  
type A

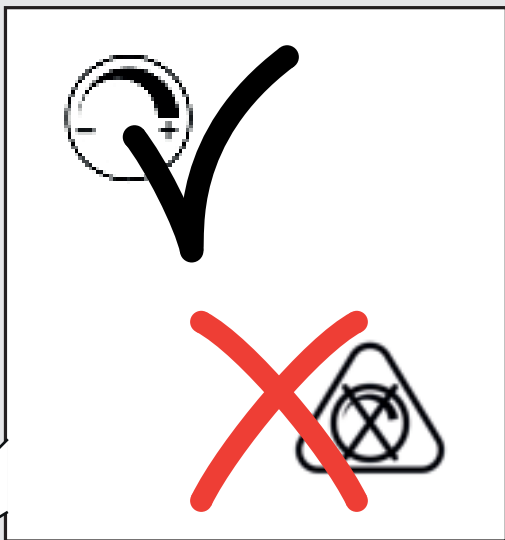
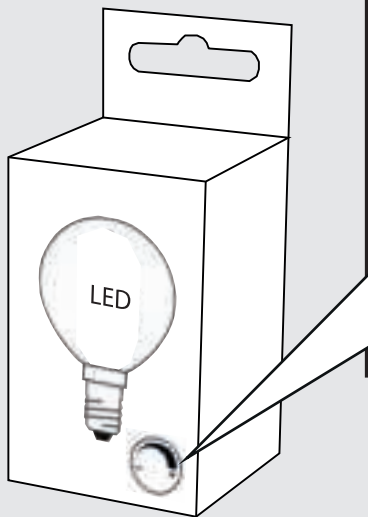



# Artemide®



## **Artemide**

via Bergamo, 18  
20010 Pregnana M.se (MI)  
ITALIA

tel. +39 02 935 181  
fax +39 02 935 90 254  
fax +39 02 935 90 496

[www.artemide.com](http://www.artemide.com)

VAT IT00846890150

## **Artemide Inc.**

250 Karin Lane  
Hicksville, NY 11801

Tel. 631 694 9292  
Toll Free 1-877-Art-9111  
Fax 631 694 9275

[www.artemide.net](http://www.artemide.net)

## **Artemide Ltée/Ltd.**

11105 rue Renaude Lapointe  
Montréal, Québec H1J 2T4

Tel. 514 323 6537  
Toll Free 888 777 2783  
Fax 514 323 8864

[www.artemide.net](http://www.artemide.net)

cod. Y513001192