



User Manual

Air Purifier



VK-6082AU

Contents

1. Important safety information.....	01
2. Product Structure.....	02
3. Before first use.....	03
4. Using the appliance.....	05
5. Filter Replacement.....	07
6. UV-C bulb Replacement.....	09
7. Keep Filter Clean.....	10
8. Storage.....	10
9. Environment.....	10
10. Troubleshooting.....	11
11. Warranty Terms.....	12

1. Important Safety Information

Read this user manual carefully before you use the appliance and save it for future reference.

Danger

- Do not let water or any other liquid or flammable detergent enter the appliance to avoid electric shock and/or a fire hazard.
- Do not clean the appliance with water or any other liquid or a (flammable) detergent to avoid electric shock and/or a fire hazard.

Warning

- Check if the voltage indicated on the appliance corresponds to the local mains voltage before you connect the appliance.
- If the mains cord is damaged, you must have it replaced by distributor, or a service centre authorized by distributor or similarly qualified persons in order to avoid hazard.
- Do not use the appliance if the plug, the mains cord or the appliance itself is damaged.
- This appliance is not intended for use by persons (including children) with reduced physical, sensory or mental capabilities, or lack of experience and knowledge, unless they have been given supervision or instruction concerning use of the appliance by a person responsible for their safety.

- Children should be supervised to ensure that they do not play with the appliance.
- Do not block the air inlet and outlet, e.g. by placing items on the air outlet or in front of the air inlet.
- To reduce the risk of fire or electric shock. DO NOT use the appliance with any solid-state speed control device.
- Skin or eye damage may result from directly viewing the light produced by the lamp in this apparatus. Always disconnect power before relamping or servicing.

Caution

- This appliance is not a substitute for proper ventilation, regular vacuum cleaning or use of an extractor hood or fan while cooking.
- If the wall socket used to power the appliance has poor connections, the plug of the appliance becomes hot. Make sure you plug the appliance into a properly connected wall socket.
- Always place and use the appliance on a dry, stable, level and horizontal surface.
- Leave at least 40cm free space behind and on both sides of the appliance and leave at least 40cm free space above the appliance.
- Do not place anything on top of the appliance and do not sit on the appliance.
- Do not place the appliance directly below an air conditioner to prevent condensation from dripping onto the appliance.
- Make sure all filters are properly installed before you switch on the appliance.
- Only use the original filters specially intended for this appliance. Do not use any other filters.
- Avoid knocking against the appliance (the air inlet and outlet in particular) with hard objects.
- Always lift or move the appliance by the handle at the back of the appliance.
- Do not insert your fingers or objects into the air outlet.
- Do not use the appliance when you have used indoor smoke-type insect repellents or in places with oily residues, burning incense or chemical fumes.
- Do not use the appliance near gas appliances, heating devices or fireplaces.
- Always unplug the appliance after use and before you clean it.
- Do not use the appliance in a room with major temperature changes, as this may cause condensation inside the appliance.
- The appliance is only intended for household use under normal operating conditions.
- Do not use the appliance in wet surroundings or in surroundings with high ambient temperatures, such as the bathroom, toilet or kitchen.

- The appliance does not remove carbon monoxide (CO) or radon (Rn). It cannot be used as a safety device in case of accidents with combustion processes and hazardous chemicals.
- To prevent interference, should be kept at least 2 meters distance between the product and the use of radio waves electrical.

2. Product Structure

Welcome using our company air purifier, before using please read this manual carefully to operate the product correctly.

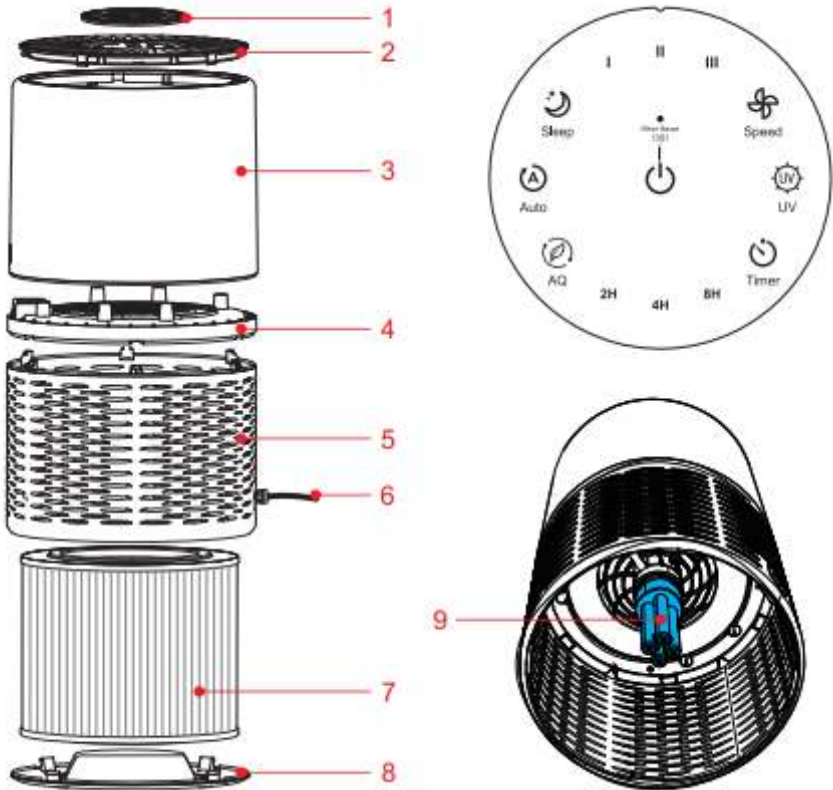

1. Control panel
2. Outlet cover
3. Upper body
4. Decorative ring
5. Lower body

6. Power cord
7. Combination filter
8. Base cover
9. UV-C bulb

(Model no. xxxx)

3. Before first use

Placing the filters

The appliance comes with all filters fitted inside, but you have to remove the packaging of the filters before you can use the appliance. Remove all filters, unpack them and place them back into the appliance as described below.

Note: Make sure your filters purchased from the original manufacturer and put it in the correct position.

1. Put the appliance upside down on a soft cloth to avoid scratching, to open the base cover, you need to corresponding the **LOCK** position, turn the base cover counterclockwise from **LOCK** to **OPEN** positionn, then the lock released.

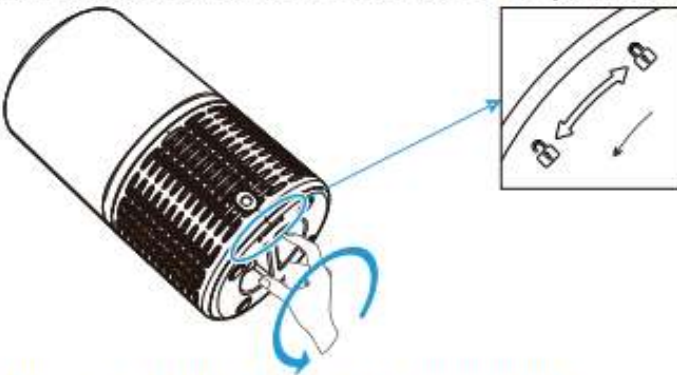

2. Remove the base cover and take out the combination filters.
3. Remove the packaging material from the filter.

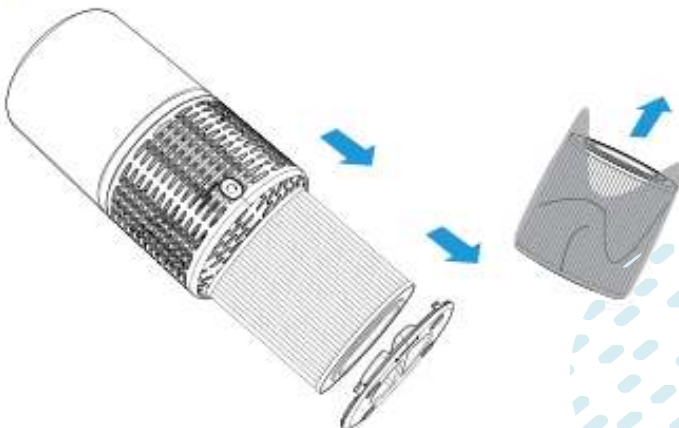

- Put the filter back into the appliance.

Note: Make sure that the side with the tag is pointing towards you.

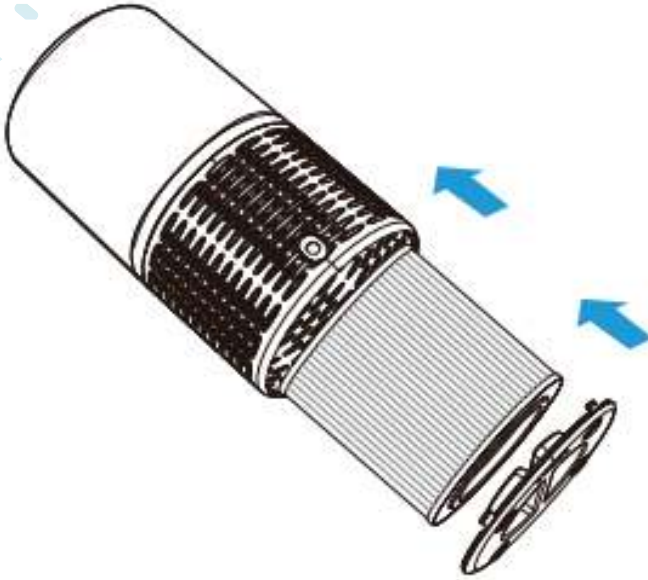

- Twist the filter cover clockwise to the "LOCK" position to secure the filters. The filter cover should snap shut.

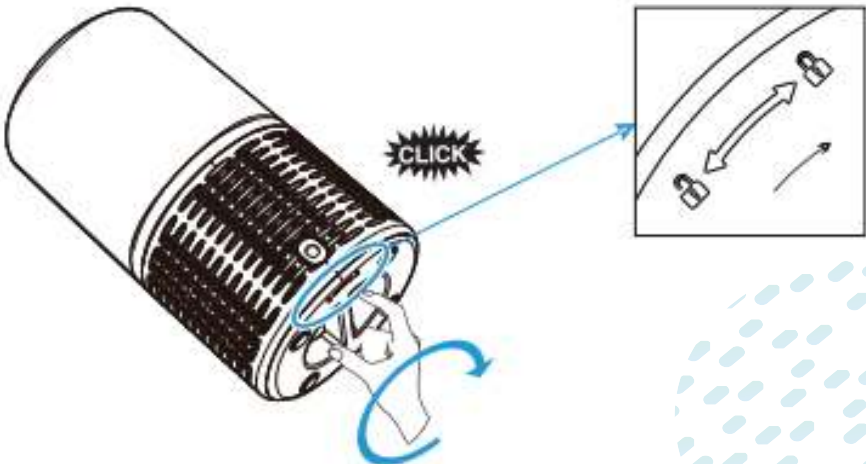

4. Using the appliance

4.1 About the control panel

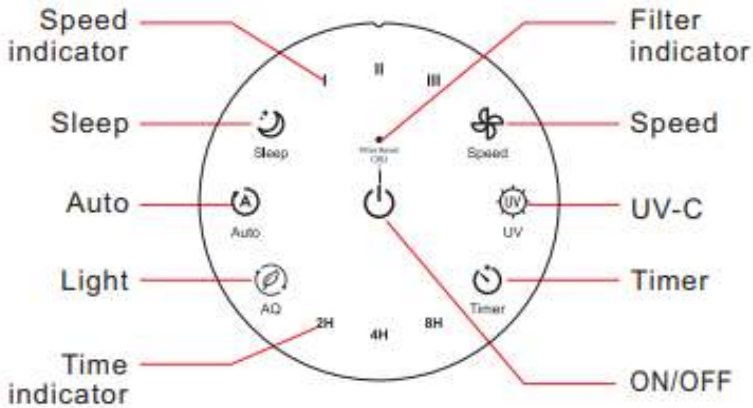

1. Plug the air purifier into a powered electrical outlet.

2. Press the power button to switch on the appliance.

Press  button, AQ light turns on and Speed at level 1 (Low)



3. Fan speed adjustment 

The fan speed light indicates at which fan speed the appliance is operating. I-III refers to Low, Medium, High level.

4. Auto mode 

At Auto mode, the fan speed will be automatically adjusted according to AQI level as below:

AQ Color	Blue	Green	Orange	Red
Speed mode	Sleep	I (Low)	II (Medium)	III (High)
AQ level	Very good	Good	Unhealthy	Hazardous

5. Sleep mode

1. Press  to turn Sleep Mode on and Sleep indicator turn brightness. All indicators will be at half brightness, air purifier will work in the lowest fan.
2. **Sleep, UV, Power and Timer** indicators will be at half brightness while sleep mode is on. And the indicators will be light up while tap all buttons except Timer, UV or Power.
3. **AQ** light indicator will display the color according to the air quality.

Note: The operation will not work in Standby Mode.

6. Light

Press  button, air quality indicator and all buttons will be off.



Press AQ button again to turn on the air quality indicator.

7. UV-C technology

The UV-C technology kills germs, viruses, and bacterial by penetrating its DNA, resulting in the microorganism's death or the inability to reproduce.

Press  button to turn the UV-C technology on. The UV-C indicator will glow. Press  button again to turn the UV-C technology off.

8. Setting timer

- Press  to turn on or off the timer, and to cycle through timer options (2 hours, 4 hours, or 8 hours)
- The air purifier will automatically power off once the timer is finished. **NOTE:** Press  or unplugging the air purifier will cancel the timer.

9. Filter replacement light

When filter indicator lights, it means that you should check the filter if it needs to be cleaned or replaced.

Note: The filter's lifetime is based to your house air quality and using time. Using the appliance in a humid environment will reduce the lifetime of the filter.

10. Memory Function

The air purifier has the setting memory while the users turn it off, including fan speed. It will return to the last setting while the users turn it on again.

5. Filter Replacement

1. Switch off the appliance and unplug it. (a)



2. Put the appliance upside down on a soft cloth to avoid scratching, to open the base cover, you need to corresponding the LOCK position, turn the base cover counterclockwise from LOCK to OPEN position, then the lock released. (b)

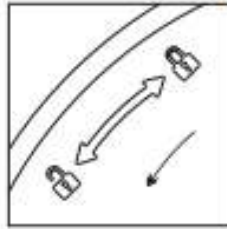
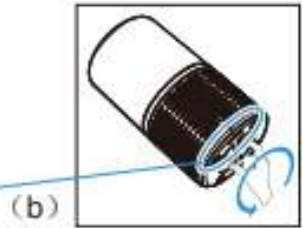

3. To remove the base cover and combination filter, grab filter tag and pull it towards you. (c)



4. Remove the packaging material of the new combination filter. (d)

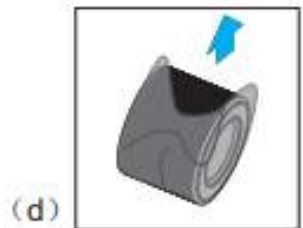

5. Put the new filter back into the appliance. (3)

Note: For HEPA filter, make sure that the side with the tag is pointing towards you.



6. Turn the base cover clockwise from OPEN position to LOCK position, you will hear a "click" sound, the base cover is fastened. (f)

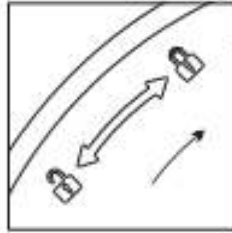

7. Put the plug in the wall socket and switch on the appliance again. (g)



8. Reset Filter's lifetime.

Even you replace the filters, when you switch on the appliance, the filter icon  still light, you need to reset the filter's lifetime, so that the appliance can cycle to calculate the filters' working time.

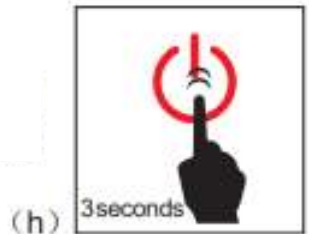

Press and hold the button for 3seconds, the filter light  turn off, the reset is finished. (h)



Filter replacement force mode

Suppose you use the appliance under air pollution environment, you can replace the filter even the filter icon does not light, the filter replacing method is same, please see chapter: **Filter replacement**.

To force reset the filter's lifetime:

At the standby mode, press and hold on  button for 3 seconds, the icon  light on, press and hold  button 3 seconds again, the filter light turn off, then the reset is finished.

6. Replacing the UV-C bulb

The UV-C bulb is designed to last for approximately 5000 hours of use. The UV-C indicator on the control panel will flash RED when you use UV-C exceed 5000 hrs.

NOTE: The air purifier will continue to operate without UV-C function when the UV-C bulb burns out.

CAUTION: Do not operate the air purifier without the protective UV-C bulb cover.

1. Unplug the air purifier and remove the filter. (a)
2. Remove the cover to expose the UV-C bulb. (b)
3. Gently push from the side and rotate the UV-C bulb to remove. (c)
4. Remove and replace the UV-C bulb. Re-install the UV-C bulb cover, filter and base cover. (d)(e)
5. Put the plug in the wall socket and switch on the appliance again. (f)
6. Press and hold on the button for 3 seconds, after hearing the buzzer "Ding", the UV-C indicator will flash 3 times and then turn off, the reset is finished. (g)

NOTE: You can replace the UV-C bulb ahead of time and reset the lifetime, even if the UV-C indicator light does not flash.

WARNING: The UV-C bulb contains mercury (Hg).

WARNING: Skin or eye damage may result from directly viewing the light produced by the lamp in this apparatus.

CAUTION: Unplug the power cord before servicing or replacing the UV-C bulb.

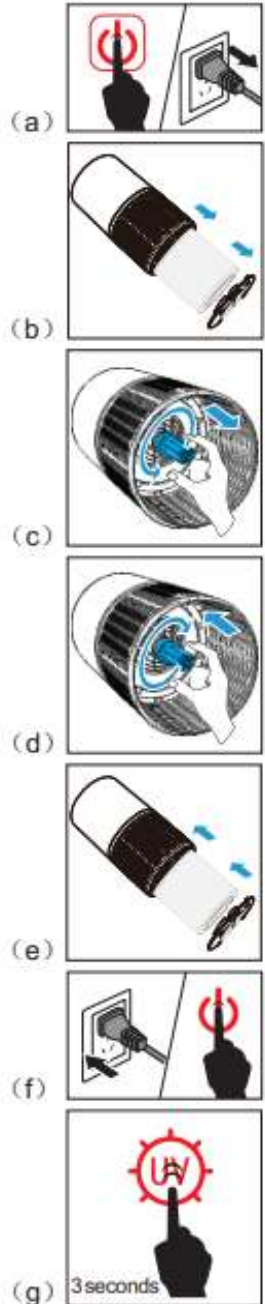

7. Keep Filter Clean

In order to keep your purifier working with more efficiency and life-time, clean the filter (pre-filter side only) every 2 weeks with the instruction below:

1. Clean out any dust, hair, or furs remain on the pre-filter by using the vacuum hose.
2. Clean out any dust, hair, or furs remain on the bottom cover by using the vacuum hose.
3. DO NOT wash the filter with any water or liquid.



8. Keep Filter Clean

Unplug the power cord, then wipe the machine clean, put the appliance in the packing bag, then put it in a dry place away.

9. Environment

Do not throw away the appliance with the normal household waste at the end of its life, but hand it in at an official collection point for recycling. By doing this, you help to preserve the environment.

10. Troubleshooting

This chapter summarises the most common problems you could encounter with the appliance. If you are unable to solve problem with the information below, contact the Consumer Care Centre in your country.

Problem	Cause	Solution
Air purifier does not power on.	Unit is not plugged into an electrical outlet.	Connect the plug to a powered electrical outlet.
	Outlet is not working properly.	Try plugging the air purifier into a different outlet.
	Power button has not been pressed after plugging in the air purifier.	Press "" once to turn on the air purifier.
	Power cord is damaged.	Immediately discontinue use and contact Customer Support.
	Air purifier is defective or malfunctioning.	
Air purifier does not respond to button controls.	Air purifier is not plugged into an outlet.	Connect the plug to a powered electrical outlet.
	Air purifier is defective or malfunctioning.	Immediately discontinue use and contact Customer Support.
Air purifier makes an unusual noise while operating.	Air filters are dirty.	Replace the air filters as instructed in the Filter Replacement section.
	Filter does not fit properly.	Properly place filter(s) as noted in the Before first use and Filter Replacement sections.
	Foreign object inside the unit.	Immediately discontinue use and contact Customer Support. DO NOT attempt to open the air purifier.
Significantly reduced airflow.	Filter packaging has not been removed.	Remove filter from packaging before use.
	Fan speed is low.	Press "" to adjust fan speed.
	Air filters need to be replaced.	Replace the air filters as instructed in the Filter Replacement section.
	Not enough clearance on all sides of the purifier.	Ensure there is at least 38cm (15 inches) of clearance on all sides of the purifier.
Poor air purification quality.	Air filters need to be replaced.	Replace the air filters as instructed in the Filter Replacement section.
	Room is too large for the air purifier's applicable area.	Ensure the room is smaller than (280ft ²)
	Air inlet or outlet is blocked.	Remove objects blocking air inlet and outlet.
	Filters not properly placed in housing.	Properly place filters as noted in the Before first use and Filter Replacement sections.
Filter reset button is still illuminated after replacing the air filters.	The air purifier has been reset incorrectly.	See the Filter Replacement section on how to properly reset the unit.
Air purifier turns on, then suddenly turns off.	Air purifier is defective or malfunctioning.	Immediately discontinue use and contact Customer Support. DO NOT attempt to open the air purifier for self-servicing.
Air purifier beeps repeatedly after being powered on or plugged in.		



 Qumax



Made in China



Handleiding

Luchtreiniger



VK-6082AU

Inhoud

1. Belangrijke veiligheidsinformatie.....	01
2. Productopbouw.....	02
3. Voor het eerste gebruik.....	03
4. Gebruik van het apparaat.....	05
5. Filter vervanging.....	07
6. Vervang de UV-C lamp.....	09
7. Houd het filter schoon.....	10
8. Opslag.....	10
9. Veel voorkomende problemen & oplossingen.....	10

1. Belangrijke veiligheidsinformatie

Lees deze handleiding zorgvuldig door en bewaar het voor toekomstig gebruik.

Gevaar

- Zorg dat er geen vloeistof in het apparaat terecht komt om elektrische schokken of vuurgevaar te vermijden
- Maak het apparaat niet schoon met water of ander vloeistof.

Waarschuwing

- Controleer of de spanning van het apparaat overeenkomt met de netspanning voor gebruik.
- Als de stroomkabel of stekker beschadigd is, moet je het niet meer gebruiken. Dit om gevaar te voorkomen.
- Kinderen en mensen met een verstandelijke of lichamelijke beperking dienen het apparaat te gebruiken onder begeleiding.
- Het is geen speelgoed voor kinderen.
- Blokkeer de in- en uitgaande lucht niet en leg er niks voor.
- Kijk niet direct in de lamp, want hierdoor beschadig je mogelijk je ogen en huid.

Opletten

- Dit apparaat is geen vervanging van een airco, stofzuigsysteem of afzuigkap.
- Zorg ervoor dat de stekker in een degelijk stopcontact zit. Een slechte connectie zorgt ervoor dat de stekker heet wordt.
- Plaats het apparaat op een droog, stabiel en horizontaal oppervlak.
- Zorg dat er minimaal 40 centimeter aan alle kanten van de luchtreiniger zit (ook boven).
- Plaats niks op het apparaat en ga er niet op zitten.
- Plaats het niet onder een airco, aangezien hier mogelijk druppels van af vallen.
- Zorg dat alle filters goed zijn geïnstalleerd, voordat je het aan zet.
- Gebruik slechts de originele filters en gebruik geen filters van een ander merk.
- Vermijd harde stoten tegen het apparaat.
- Stop je vingers niet in het gat waar de lucht uit komt.
- Gebruik het apparaat niet op plekken met olieresten of chemische stoffen.
- Gebruik het apparaat niet in de buurt van gastoestellen, verwarmingsapparaten of openhaarden.
- Verwijder de stekker uit het stopcontact na gebruik en voor het schoonmaken.
- Gebruik het apparaat niet in een kamer met hoge temperatuurverschillen. Hierdoor is condensatie in het apparaat mogelijk.
- Het apparaat is slechts bedoeld voor gebruik in huis onder normale omstandigheden.
- Gebruik het apparaat niet in natte of erg vochtige kamers zoals een badkamer, toilet of keuken.
- Het apparaat haalt geen koolmonoxide of radon weg.
- Houd het apparaat altijd twee meter vandaan bij elektrische radiogolven.

2. Productopbouw

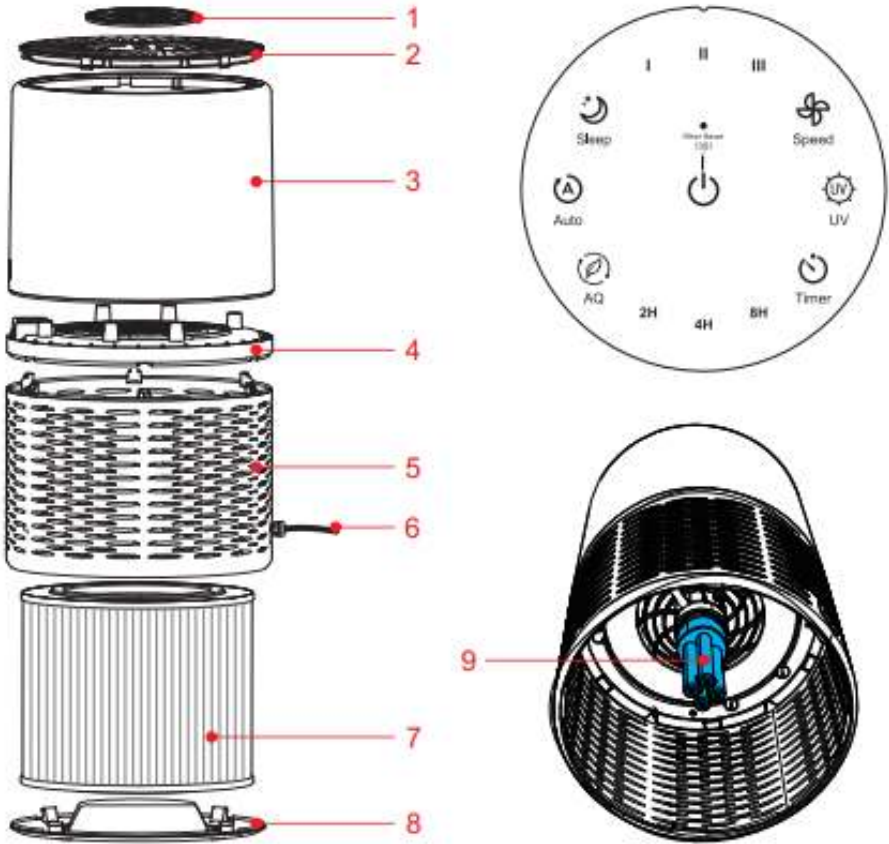

1. Bediening
2. Uitlaatklep
3. Bovenstuk
4. Decoratie ring
5. Onderstuk

6. Stroomkabel
7. Combinatie filter
8. Onderplaat
9. UV-C lamp

3. Voor het eerste gebruik

Plaats de filters

Het apparaat komt met een filter in binnen in. Je moet wel eerst de verpakking van het filter verwijderen.

Haal het filter eruit, verwijder de verpakking, en plaats het weer terug.

Let op: Zorg ervoor dat je de filters van de verkoper gebruikt, en geen filters van andere merken.

1. Houd het apparaat op de kop en leg het op een zachte ondergrond om krassen te voorkomen. Om het te openen, draai je de onderplaat tegen de klok in.

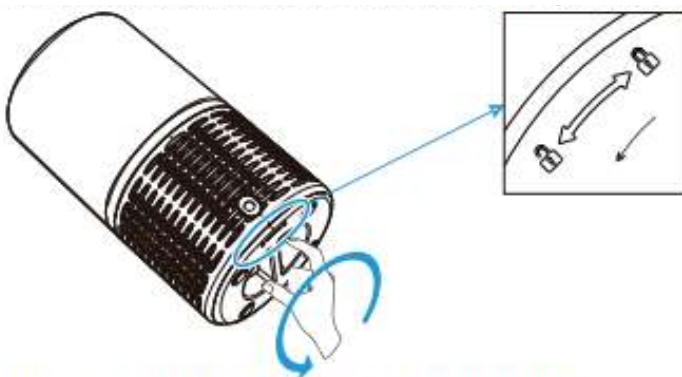

2. Verwijder de onderplaat en haal het filter eruit.
3. Verwijder vervolgens het verpakkingsmateriaal.

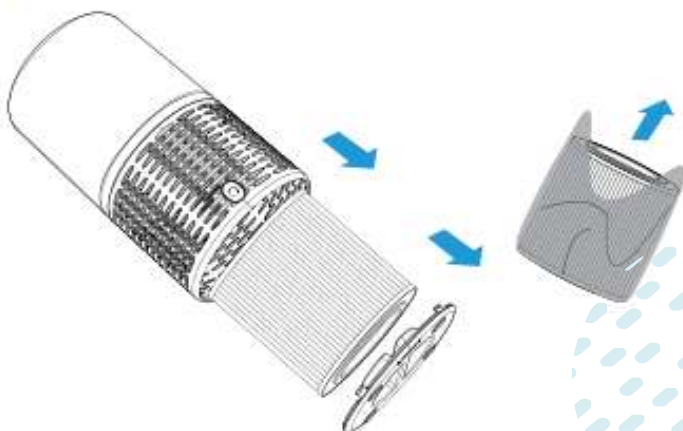

4. Stop het filter terug in het apparaat.

Let op: Zorg dat de kant met de tag naar jou wijst.

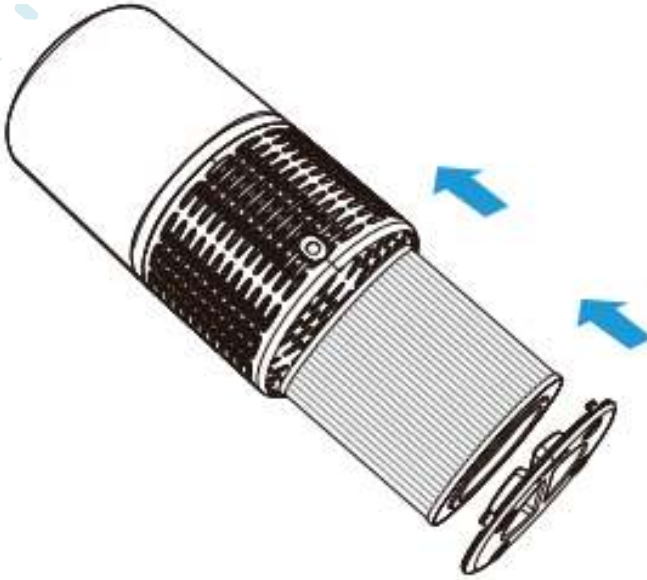

5. Draai de onderplaat met de klok mee om het weer te vergrendelen. Je zou een 'click' moeten horen.

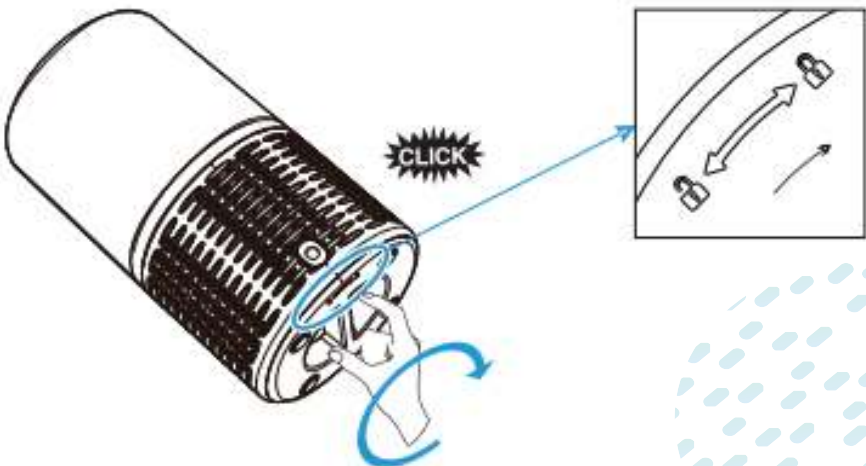

4. Gebruik van het apparaat

4.1 De bediening

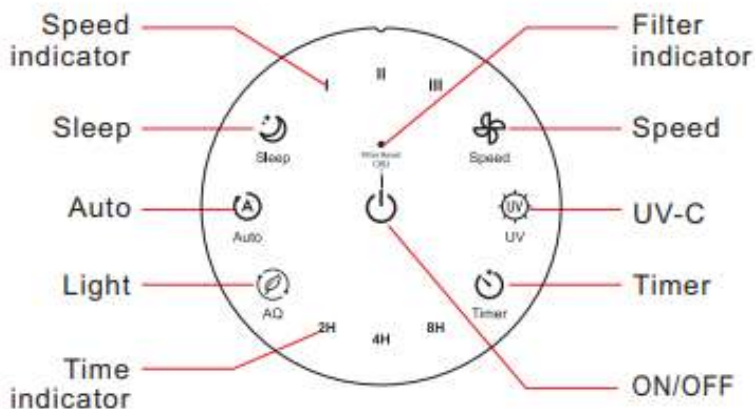

1. Plug het apparaat in het stopcontact.

2. Druk  op de aanknop. Het licht gaat aan en de snelheid staat op.



3. Het snelheidslichtje geeft aan op welke snelheid het apparaat aan staat. Druk op de snelheid knop  om de snelheid aan te passen. Er zijn 3 standen: Laag, Medium, Hoog

4. Auto-modus 

Het apparaat zal zelf de snelheid aanpassen aan de hand van de luchtkwaliteit. Zie hieronder:

Lamp kleur	Blauw	Groen	Orange	Rood
Snelheid	Slaapstand	Laag	Medium	Hoog
Luchtkwaliteit	Super goed	goed	Ongezond	Gevaarlijk

5. Slaapstand

1. Druk  op de slaapstand om deze in te schakelen.
2. Alle indicatoren zullen minder fel worden en de luchtreiniger werkt op de laatste stand.
3. De lamp indicator zal de kleur laten zien op basis van luchtkwaliteit. Dit werkt niet in Standby.

6. Licht

Druk  op de lichtknop. De lampjes op de bediening gaan nu uit. Druk nogmaals om het weer aan te zetten.

Druk op de UV-C knop om het aan te zetten en druk nogmaals om weer uit te zetten. Het doodt bacteriën en virussen.

7. Timer

Druk op de timer knop om hem aan of uit te zetten, en om door de timer opties heen te gaan.

De luchtreiniger gaat automatisch uit zodra de tijd is verstreken.

8. Filter vervang lampje

Zodra het filterlampje gaat branden, is het tijd om het filter te controleren en schoon te maken of te vervangen.

De levensduur van het filter hangt af van de luchtkwaliteit en de gebruiksduur. In een vochtige omgeving zal het filter minder lang meegaan.

9. Geheugen

Het filter onthoudt de instellingen (incl snelheid) zodra je het apparaat uit zet. Bij het inschakelen zal hij deze instellingen opnieuw uitvoeren.

5. Filter vervanging

1. Doe het apparaat uit en haal de stekker uit het stopcontact. (a)



2. Houd het apparaat op de kop en leg het op een zachte ondergrond om krassen te voorkomen. Om het te openen, draai de onderplaat tegen de klok in. (b)

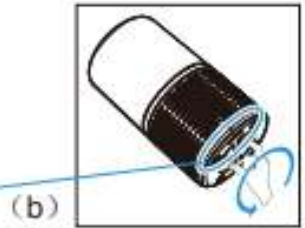
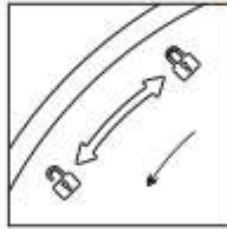

3. Grijp de onderplaat en trek naar je toe. (c)



4. Verwijder de verpakking van het nieuwe filter. (d)

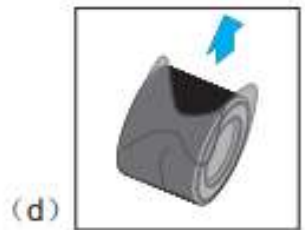

5. Stop het nieuwe filter terug in de luchtreiniger. (e)



6. Draai de onderplaat met de klok mee om het weer te vergrendelen. Je zou een 'click' moeten horen.

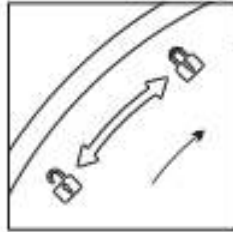

(f)

7. Stop de stekker in het stopcontact en doe de luchtreiniger weer aan.



(g)

8. Reset de levensduur van het filter.

Na vervanging van het filter zal het lampje nog steeds branden. Je moet de indicator resetten na vervanging.

Druk de aaknop in voor 3 seconden. Het filterlampje zal nu uitgaan en de reset is gelukt.



(h)

6. Vervang de UV-C lamp

De lamp is ontworpen om ongeveer 5000 uur mee te gaan. Het indicatielampje zal rood knipperen zodra deze uren zijn overschreden.

De luchtreiniger doet het gewoon nadat de UV-C lamp niet meer werkt.

1. Haal de stekker uit het stopcontact en haal het filter eruit. (a)
2. Haal de UV-C cover van de lamp af. (b)



(a)



(b)

1. Draai zachtjes het lampje om hem te verwijderen. (c)
2. Haal de lamp eruit en vervang deze. Doe de cover en het filter er weer op en sluit het apparaat. (d & e)
3. Stop de stekker in het stopcontact en doe het apparaat aan. (f)
4. Druk de UV-C knop in en houd 3 seconden in. Nu is de lampindicatie gereset. (g)

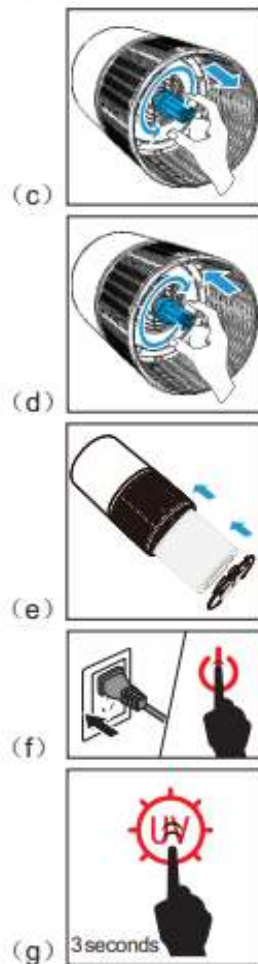

7. Houd het filter schoon

Om het apparaat goed te laten werken en langer mee te laten gaan, is het belangrijk om het filter elke twee weken schoon te maken:

1. Haal stof, haar en vacht weg uit het voorfilter met een stofzuigerslang.
2. Gebruik absoluut geen water of andere vloeistof bij het schoonmaken.



8. Opslag

Haal de stekker uit het stopcontact en maak het apparaat schoon. Stop het weg op een droge plek.

9. Veel voorkomende problemen & oplossingen

Probleem	Oorzaak	Oplossing
Het apparaat gaat niet aan.	Stekker zit er niet in.	Stop de stekker in het stopcontact.
	Stopcontact werkt niet.	Probeer een ander stopcontact.
	Aanknop is niet ingedrukt.	Druk op de aanknop.
	Kabel is beschadigd.	Neem contact op met klantenservice.
	Apparaat is defect.	
De bediening werkt niet.	Stekker zit er niet in.	Stop de stekker in het stopcontact.
	Apparaat is defect.	Neem contact op met klantenservice.
Het apparaat maakt een raar geluid.	De filters zijn vies.	Maak schoon of vervang de filters.
	Filter past niet goed in het apparaat.	Maak gebruik van originele filters.
	Filter niet uit de verpakking gehaald.	Verwijder de verpakking.
Een significant verminderde luchtstroom.	Apparaat staat op snelheid laag.	Gebruik de snelheid knop.
	Filters moeten worden schoongemaakt of vervangen.	Maak schoon of vervang de filters.
	Niet genoeg ruimte om het apparaat.	Zorg voor 40 centimeter rondom het apparaat.
	Filters moeten worden schoongemaakt of vervangen.	Maak schoon of vervang de filters.
Slechte	De kamer is te groot voor het apparaat.	Zorg voor een ruimte kleine dan 85m ² .
	De in- of uitgang is geblokkeerd.	Haal de blokkerende objecten weg.
	Filter zit er niet goed in.	Plaats het filter nauwkeurig opnieuw.

 Qumax



Made in China