

30940/\*\*/16

30941/\*\*/16



Gebruiksaanwijzing

Notice d'emploi

Benutzerhandbuch

User manual

Manual de usuario

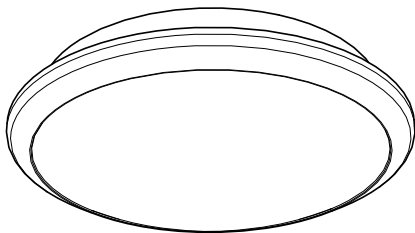

# PHILIPS

Incl.

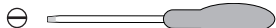
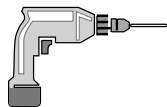
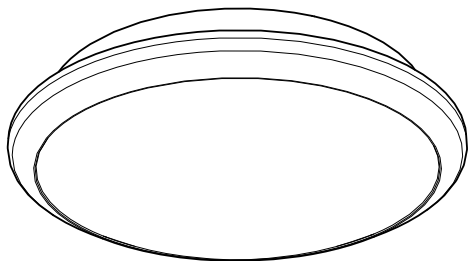

Type 1 P.4

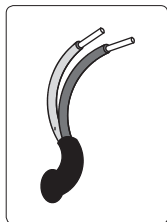
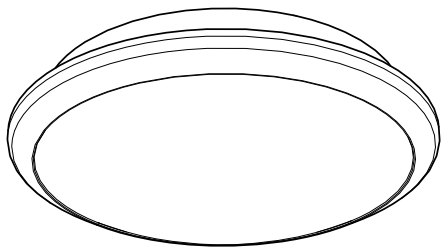

Type 2 P.8

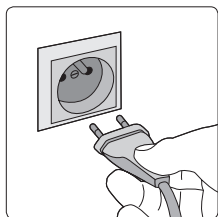
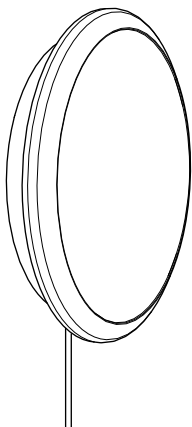

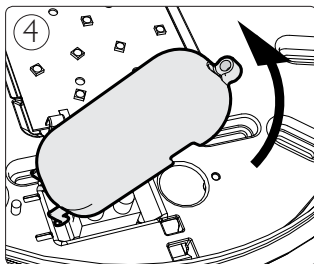
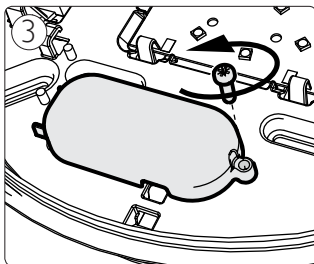
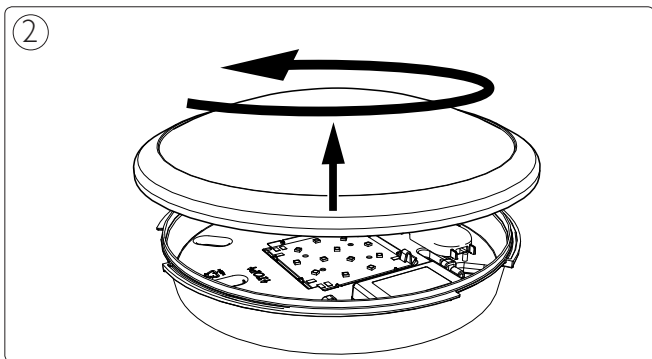
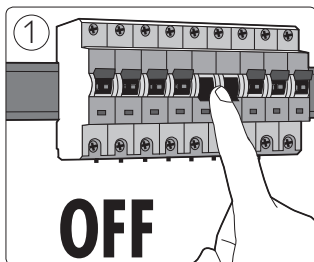
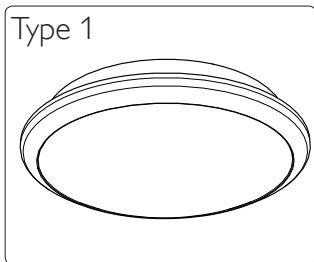

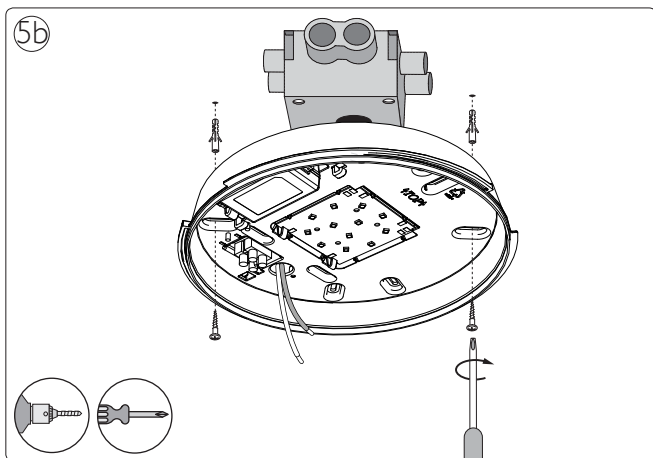
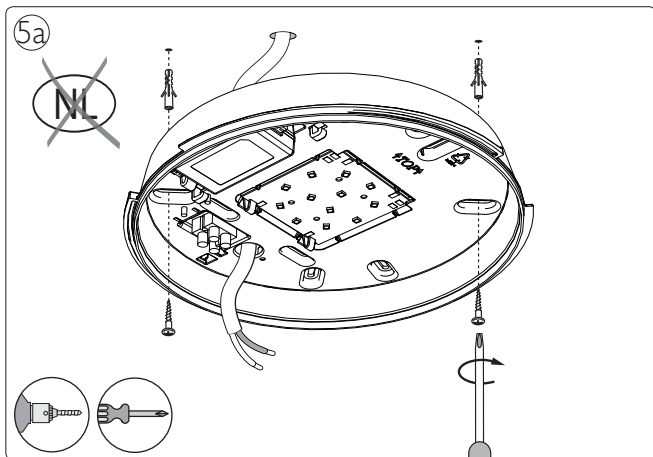

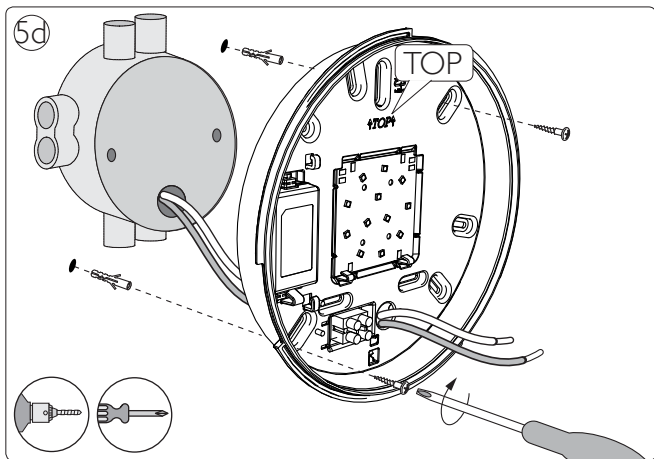
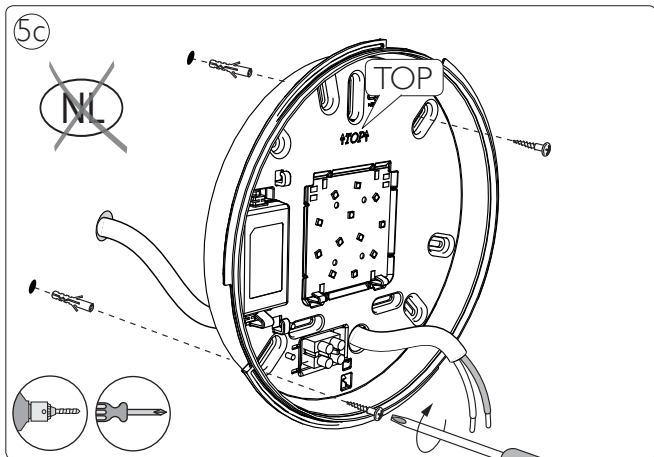

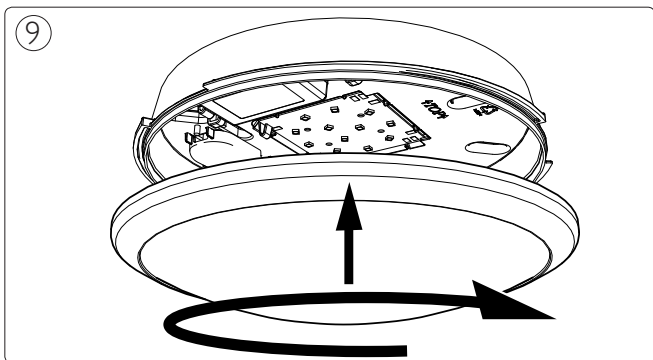
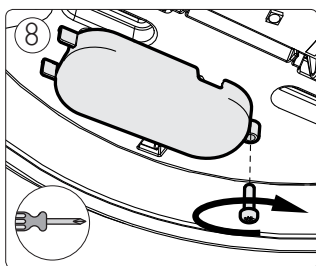
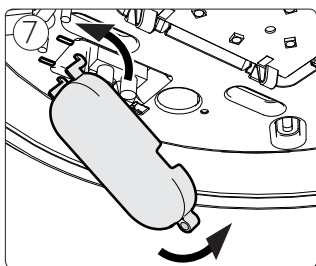
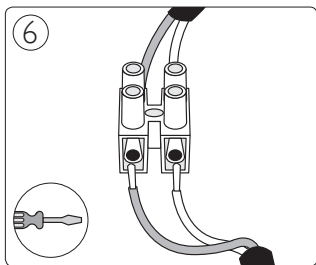

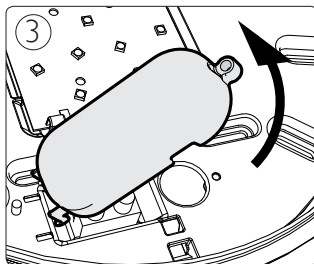
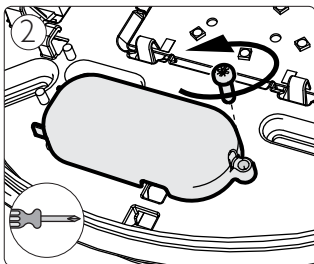
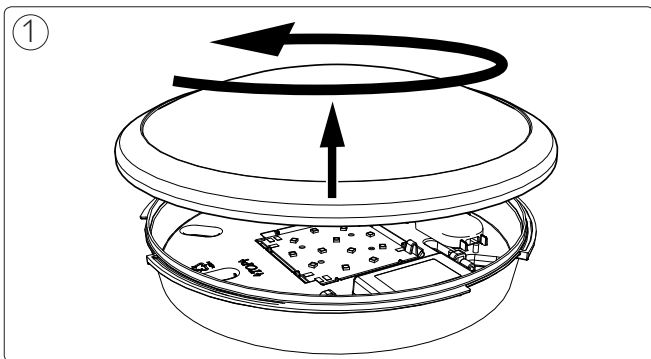
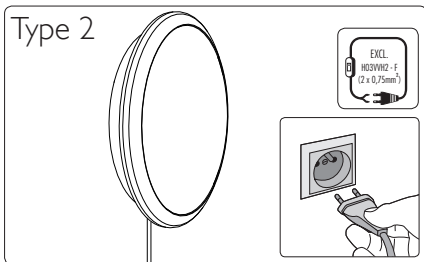



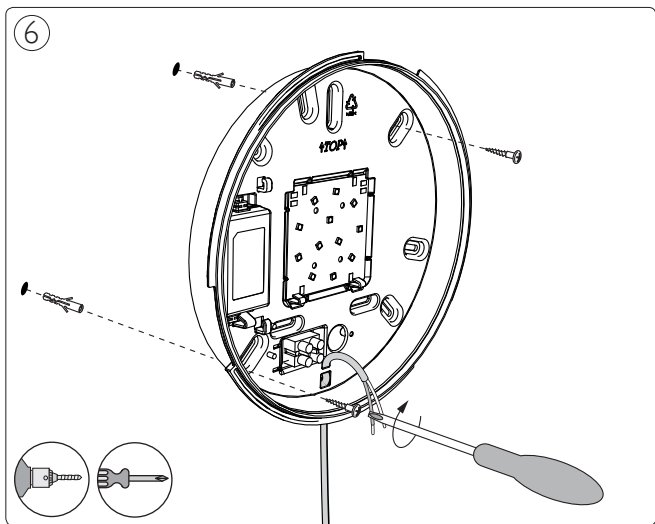
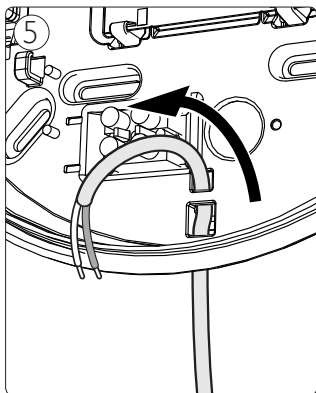
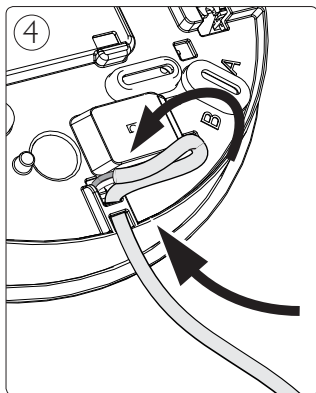

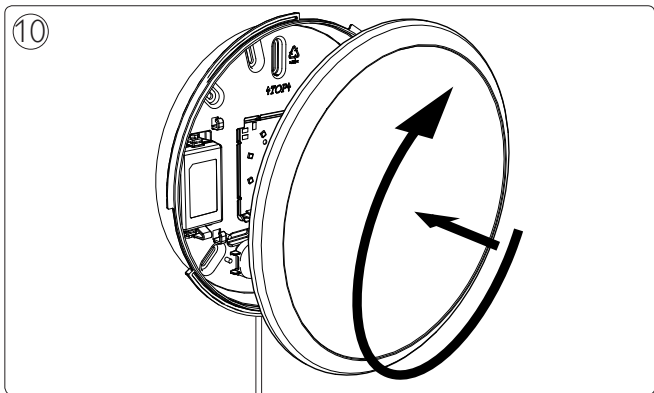
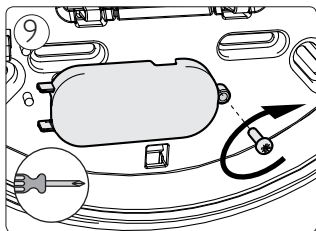
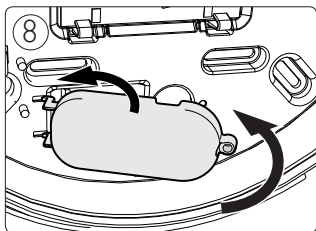
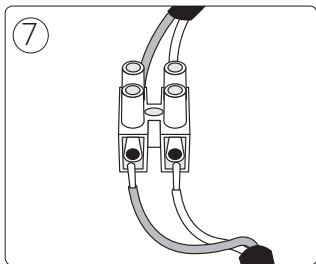

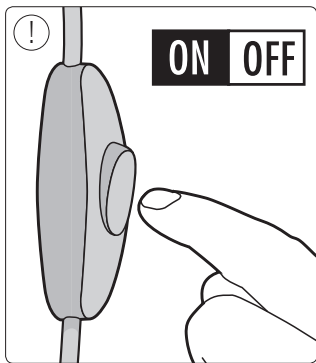
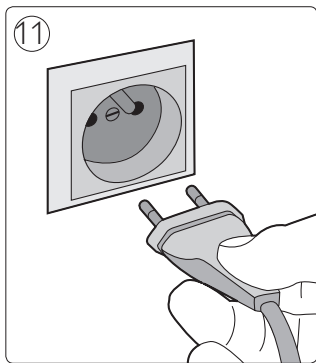



Philips Lighting Contact Centre  
Int. Business Reply Service  
I.B.R.S. / C.C.R.I. Numéro 10461  
5600 VB Eindhoven  
Pays-Bas / The Netherlands

[www.philips.com/homelighting](http://www.philips.com/homelighting)  
 +800 7445 4775

4404.016.91491  
Last update: 06/02/13